

# Model Name: T240XVN02.0

Issue Date: 2012/02/15

( ) Preliminary Specifications

(\*) Final Specifications

Customer Signature	Date	AUO	Date
Approved By  _____		Approval By PM Director <i>Kelly Ho</i> _____	
Note		Reviewed By RD Director <i>陳品川</i> _____	
		Reviewed By Project Leader <i>石秉弘</i> _____	
		Prepared By PM <i>Kelly Tseng</i> _____	

## Contents

No		
		CONTENTS
		RECORD OF REVISIONS
1		GENERAL DESCRIPTION
2		ABSOLUTE MAXIMUM RATINGS
3		ELECTRICAL SPECIFICATION
	3-1	ELECTRICAL CHARACTERISTICS
	3-2	INTERFACE CONNECTIONS
	3-3	SIGNAL TIMING SPECIFICATION
	3-4	SIGNAL TIMING WAVEFORM
	3-5	COLOR INPUT DATA REFERENCE
	3-6	POWER SEQUENCE
	3-7	BACKLIGHT SPECIFICATION
4		OPTICAL SPECIFICATION
5		MECHANICAL CHARACTERISTICS
6		RELIABILITY TEST ITEMS
7		INTERNATIONAL STANDARD
	7-1	SAFETY
	7-2	EMC
8		PACKING
	8-1	DEFINITION OF LABEL
	8-2	PACKING METHODS
	8-3	PALLET AND SHIPMENT INFORMATION
9		PRECAUTION
	9-1	MOUNTING PRECAUTIONS
	9-2	OPERATING PRECAUTIONS
	9-3	ELECTROSTATIC DISCHARGE CONTROL
	9-4	PRECAUTIONS FOR STRONG LIGHT EXPOSURE
	9-5	STORAGE
	9-6	HANDLING PRECAUTIONS FOR PROTECT FILM

## Record of Revision

Version	Date	Page	Description
0.0	2012/02/15		First release

## 1. General Description

This specification applies to the 24.02 inch Color TFT-LCD Module T240XVN02.0. This LCD module has a TFT active matrix type liquid crystal panel 1,366x 768 pixels, and diagonal size of 24.0 inch. This module supports 1,366x 768 mode. Each pixel is divided into Red, Green and Blue sub-pixels or dots which are arranged in vertical stripes. Gray scale or the brightness of the sub-pixel color is determined with a 8-bit gray scale signal for each dot. The T240XVN02.0 has been designed to apply the 8-bit 1 channel LVDS interface method. It is intended to support displays where high brightness, wide viewing angle, high color saturation, and high color depth are very important. This module is not equipped with inverter board for backlight.

Items	Specification	Unit	Note
Active Screen Size	24.02	inch	
Display Area	531.72(H) x 298.94 (V)	mm	
Outline Dimension	580.0(H) x 347.5 (V)x 46.7 (D)	mm	Without inverter
Driver Element	a-Si TFT active matrix		
Display Colors	8 bit, 16.7M	Colors	
Number of Pixels	1,366x 768	Pixel	
Pixel Pitch	0.389 (H) x 0.389 (W)	mm	
Pixel Arrangement	RGB Horizontal stripe		
Display Operation Mode	Normally Black		
Surface Treatment	Anti-Glare, 3H		Haze=2%

## 2. Absolute Maximum Ratings

The followings are maximum values which, if exceeded, may cause faulty operation or damage to the unit

Item	Symbol	Min	Max	Unit	Conditions
Logic/LCD Drive Voltage	Vcc	-0.3	14	[Volt]	Note 1
Input Voltage of Signal	Vin	-0.3	4	[Volt]	Note 1
Operating Temperature	TOP	0	+50	[°C]	Note 2
Operating Humidity	HOP	10	90	[%RH]	Note 2
Storage Temperature	TST	-20	+60	[°C]	Note 2
Storage Humidity	HST	10	90	[%RH]	Note 2
Panel Surface Temperature	PST		65	[°C]	Note 3

Note 1: Duration:50 msec.

Note 2 : Maximum Wet-Bulb should be 39°C and No condensation.

The relative humidity must not exceed 90% non-condensing at temperatures of 40°C or less. At temperatures greater than 40°C, the wet bulb temperature must not exceed 39°C.

Note 3: Surface temperature is measured at 50°C Dry condition



### 3. Electrical Specification

The T240XVN02.0 requires two power inputs. One is employed to power the LCD electronics and to drive the TFT array and liquid crystal. The second input for BLU is to power inverter.

#### 3.1.1 Electrical Characteristics

Parameter		Symbol	Value			Unit	Note
			Min.	Typ.	Max		
LCD							
Power Supply Input Voltage		$V_{DD}$	10.8	12	13.2	$V_{DC}$	1
Power Supply Input Current		$I_{DD}$	--	0.28	0.483	A	2
Power Consumption		$P_C$	--	3.363	4.275	Watt	2
Inrush Current		$I_{RUSH}$	--	--	3	A	3
LVDS Interface	Input Differential Voltage	$ V_{ID} $	200	400	600	$mV_{DC}$	4
	Differential Input High Threshold Voltage	$V_{TH}$	--	--	+100	$mV_{DC}$	4
	Differential Input Low Threshold Voltage	$V_{TL}$	-100	--	--	$mV_{DC}$	4
	Input Common Mode Voltage	$V_{ICM}$	1.1	1.25	1.4	$V_{DC}$	4
CMOS Interface	Input High Threshold Voltage	$V_{IH}$ (High)	2.7	--	3.3	$V_{DC}$	
	Input Low Threshold Voltage	$V_{IL}$ (Low)	0	--	0.6	$V_{DC}$	
Backlight Power Consumption		$P_{BL}$	45	50	55	Watt	
Life Time			50000	--	--	Hours	6

#### 3.1.2: AC Characteristics

Parameter		Symbol	Value			Unit	Note
			Min.	Typ.	Max		
LVDS Interface	Receiver Clock : Spread Spectrum Modulation range	Fclk_ss	Fclk -3%	--	Fclk +3%	MHz	7
	Receiver Clock : Spread Spectrum Modulation frequency	Fss	30	--	200	KHz	7
	Receiver Data Input Margin Fclk = 85 MHz Fclk = 65 MHz	tRMG	-0.4 -0.5	--	0.4 0.5	ns	8

**Note :**

1. The ripple voltage should be controlled under 10% of  $V_{CC}$
2. Test Condition:
  - (1)  $V_{DD} = 12V$
  - (2)  $F_v = 60Hz$
  - (3)  $F_{CLK} = \text{Max. Freq.}$
  - (4) Temperature = 25 °C

(5) Test Pattern : White Pattern

3. Measurement condition : Rising time = 400us

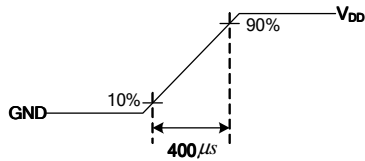

4.  $V_{ICM}$  = 1.25V

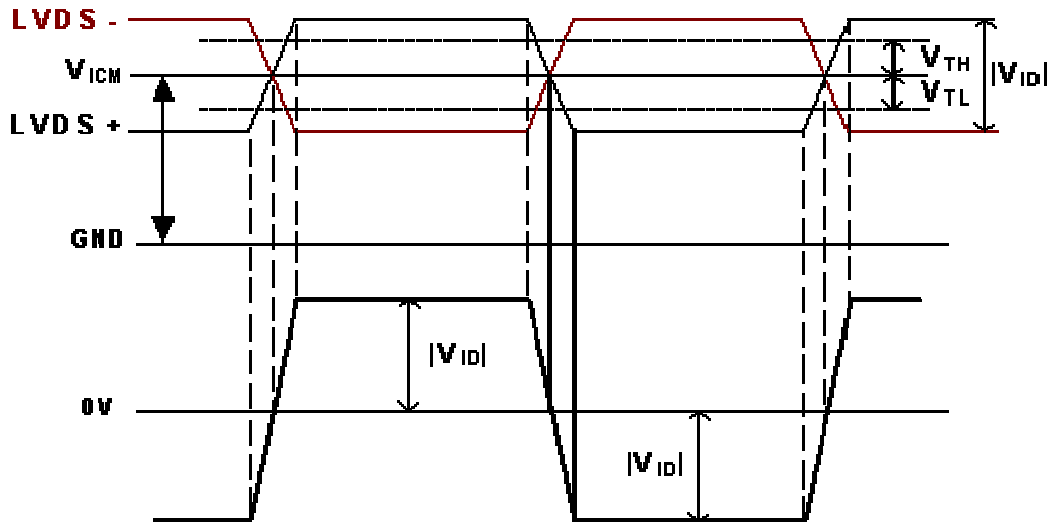

5. Input Channel Pair Skew Margin

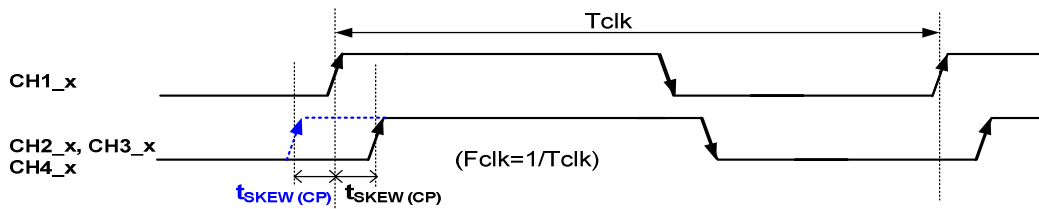

6. Specified values are for a single lamp only which is aligned horizontally. The lifetime is defined as the time which luminance of the lamp is 50% compared to its original value.

[Operating condition: Continuous operating at  $T_a = 25 \pm 2^\circ\text{C}$ ]

7. LVDS Receiver Clock SSCG (Spread spectrum clock generator) is defined as below figures

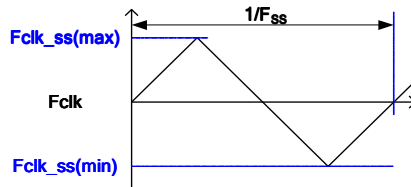

8. Receiver Data Input Margin

Parameter	Symbol	Rating			Unit	Note
		Min	Type	Max		
Input Clock Frequency	Fclk	Fclk (min)	--	Fclk (max)	MHz	$T=1/Fclk$
Input Data Position0	tRIP1	- tRMG	0	tRMG	ns	
Input Data Position1	tRIP0	$T/7 -  tRMG $	$T/7$	$T/7 +  tRMG $	ns	
Input Data Position2	tRIP6	$2T/7 -  tRMG $	$2T/7$	$2T/7 +  tRMG $	ns	
Input Data Position3	tRIP5	$3T/7 -  tRMG $	$3T/7$	$3T/7 +  tRMG $	ns	
Input Data Position4	tRIP4	$4T/7 -  tRMG $	$4T/7$	$4T/7 +  tRMG $	ns	

Input Data Position5	tRIP3	$5T/7 -  tRMG $	$5T/7$	$5T/7 +  tRMG $	ns	
Input Data Position6	tRIP2	$6T/7 -  tRMG $	$6T/7$	$6T/7 +  tRMG $	ns	

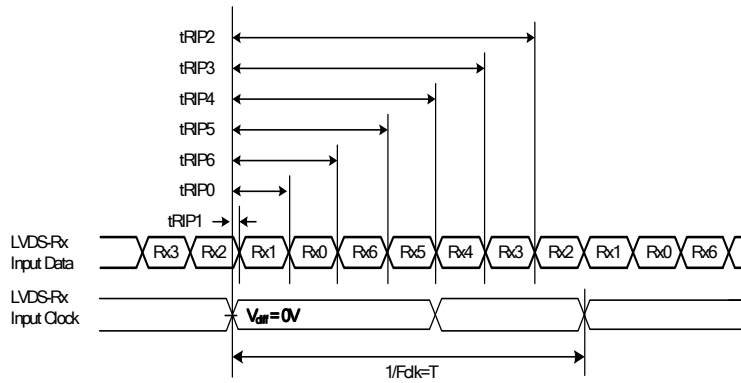



### 3.2 Interface Connections

- FFC Connector : Starconn 106F30-A00000-A2-R

PIN	Symbol	Description
1	V <sub>DD</sub>	Power Supply, +12V DC Regulated
2	V <sub>DD</sub>	Power Supply, +12V DC Regulated
3	V <sub>DD</sub>	Power Supply, +12V DC Regulated
4	V <sub>DD</sub>	Power Supply, +12V DC Regulated
5	GND	Ground
6	GND	Ground
7	GND	Ground
8	GND	Ground
9	LVDS_SEL	Open/High(3.3V) for NS, Low(GND) for JEIDA
10	N.C.	AUO Internal Use Only
11	GND	Ground
12	CH1_0-	LVDS Channel 1, Signal 0-
13	CH1_0+	LVDS Channel 1, Signal 0+
14	GND	Ground
15	CH1_1-	LVDS Channel 1, Signal 1-
16	CH1_1+	LVDS Channel 1, Signal 1+
17	GND	Ground
18	CH1_2-	LVDS Channel 1, Signal 2-
19	CH1_2+	LVDS Channel 1, Signal 2+
20	GND	Ground
21	CH1_CLK-	LVDS Channel 1, Clock -
22	CH1_CLK+	LVDS Channel 1, Clock +
23	GND	Ground
24	CH1_3-	LVDS Channel 1, Signal 3-
25	CH1_3+	LVDS Channel 1, Signal 3+
26	GND	Ground
27	N.C.	AUO Internal Use Only
28	N.C.	AUO Internal Use Only
29	N.C.	AUO Internal Use Only
30	GND	Ground

**Note: N.C. : please leave this pin unoccupied. It can not be connected by any signal (Low/GND/High).**

**LVDS Option = High/Open→NS**

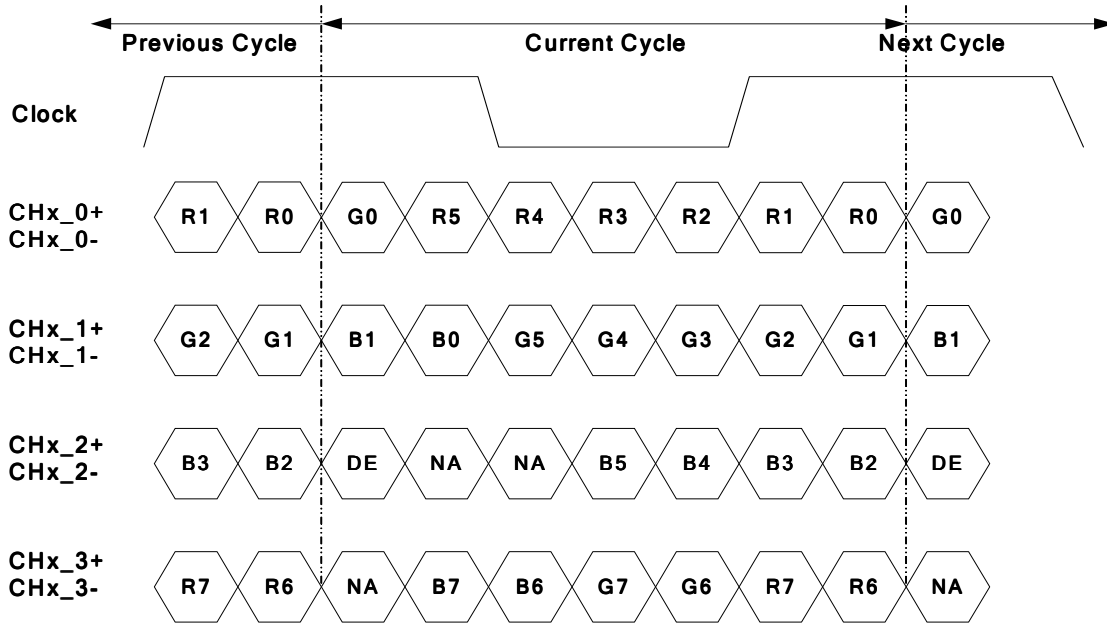

Note: x = 1, 2, 3, 4...

**LVDS Option = Low→JEIDA**

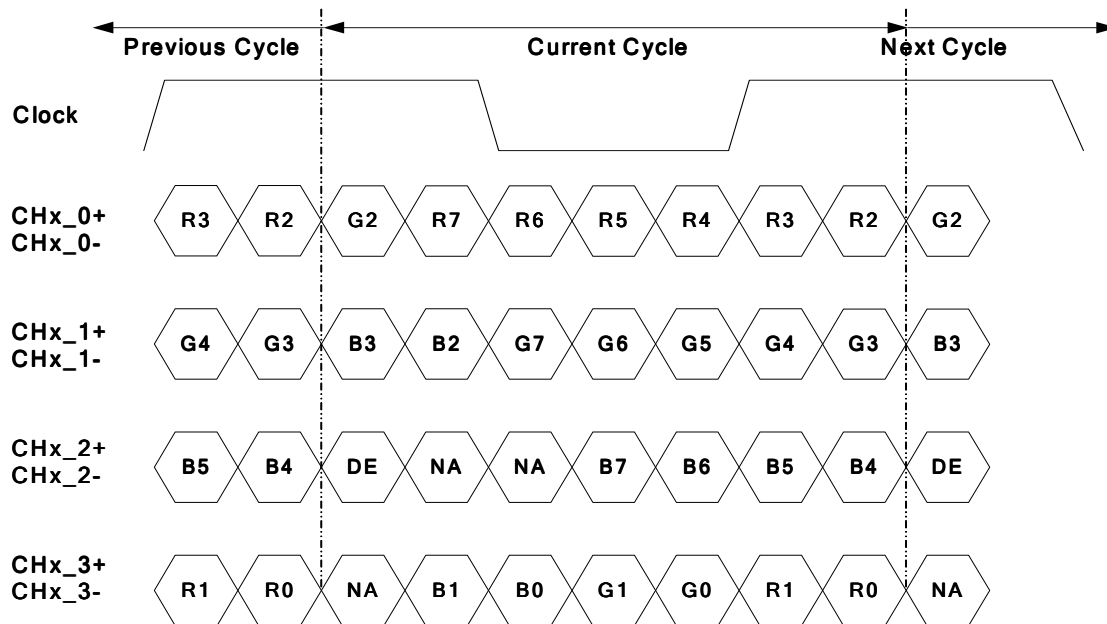

Note: x = 1, 2, 3, 4...

### 3.3 Signal Timing Specification

This is the signal timing required at the input of the user connector. All of the interface signal timing should be satisfied with the following specifications for its proper operation.

**Timing Table**

Signal	Item	Symbol	Min.	Typ.	Max	Unit
Vertical Section	Period	Tv	784	810	1015	Th
	Active	Tdisp (v)	768			
	Blanking	Tblk (v)	16	42	247	Th
Horizontal Section	Period	Th	1460	1648	2000	Tclk
	Active	Tdisp (h)	1366			
	Blanking	Tblk (h)	94	282	634	Tclk
Clock	Frequency	Fclk=1/Tclk	50	80	86	MHz
Vertical Frequency	Frequency	Fv	47	60	63	Hz
Horizontal Frequency	Frequency	Fh	43	48	53	KHz

Notes:

- (1) Display position is specific by the rise of DE signal only.  
 Horizontal display position is specified by the rising edge of 1<sup>st</sup> DCLK after the rise of 1<sup>st</sup> DE, is displayed on the left edge of the screen.
- (2) Vertical display position is specified by the rise of DE after a “Low” level period equivalent to eight times of horizontal period. The 1<sup>st</sup> data corresponding to one horizontal line after the rise of 1<sup>st</sup> DE is displayed at the top line of screen.
- (3) If a period of DE “High” is less than 1366 DCLK or less than 768 lines, the rest of the screen displays black.
- (4) The display position does not fit to the screen if a period of DE “High” and the effective data period do not synchronize with each other.

### 3.4 Signal Timing Waveforms

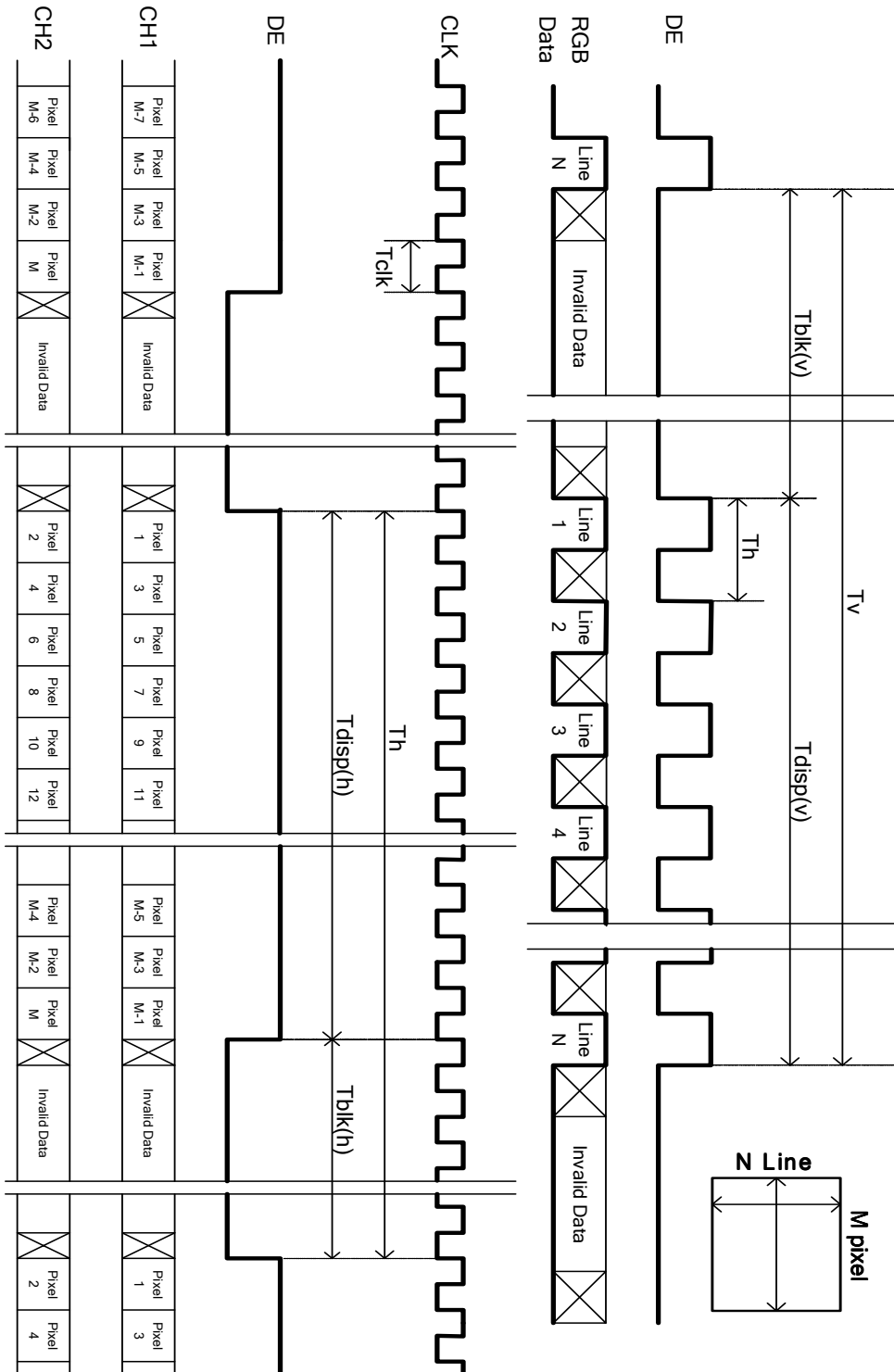

**3.5 Color Input Data Reference**

The brightness of each primary color (red, green and blue) is based on the 8 bit gray scale data input for the color; the higher the binary input, the brighter the color. The table below provides a reference for color versus data input.

**COLOR DATA REFERENCE**

Color		Input Color Data																							
		RED								GREEN								BLUE							
		MSB				LSB				MSB				LSB				MSB				LSB			
		R7	R6	R5	R4	R3	R2	R1	R0	G7	G6	G5	G4	G3	G2	G1	G0	B7	B6	B5	B4	B3	B2	B1	B0
Basic Color	Black	0	0	0	0	0	0	0	0	0	0	0	0	0	0	0	0	0	0	0	0	0	0	0	0
	Red(255)	1	1	1	1	1	1	1	1	0	0	0	0	0	0	0	0	0	0	0	0	0	0	0	0
	Green(255)	0	0	0	0	0	0	0	0	1	1	1	1	1	1	1	1	0	0	0	0	0	0	0	0
	Blue(255)	0	0	0	0	0	0	0	0	0	0	0	0	0	0	0	0	1	1	1	1	1	1	1	1
	Cyan	0	0	0	0	0	0	0	0	1	1	1	1	1	1	1	1	1	1	1	1	1	1	1	1
	Magenta	1	1	1	1	1	1	1	1	0	0	0	0	0	0	0	0	1	1	1	1	1	1	1	1
	Yellow	1	1	1	1	1	1	1	1	1	1	1	1	1	1	1	1	0	0	0	0	0	0	0	0
	White	1	1	1	1	1	1	1	1	1	1	1	1	1	1	1	1	1	1	1	1	1	1	1	1
R	RED(000)	0	0	0	0	0	0	0	0	0	0	0	0	0	0	0	0	0	0	0	0	0	0	0	0
	RED(001)	0	0	0	0	0	0	0	1	0	0	0	0	0	0	0	0	0	0	0	0	0	0	0	0
	----																								
	RED(254)	1	1	1	1	1	1	1	0	0	0	0	0	0	0	0	0	0	0	0	0	0	0	0	0
	RED(255)	1	1	1	1	1	1	1	1	0	0	0	0	0	0	0	0	0	0	0	0	0	0	0	0
G	GREEN(000)	0	0	0	0	0	0	0	0	0	0	0	0	0	0	0	0	0	0	0	0	0	0	0	0
	GREEN(001)	0	0	0	0	0	0	0	0	0	0	0	0	0	0	1	0	0	0	0	0	0	0	0	0
	----																								
	GREEN(254)	0	0	0	0	0	0	0	0	1	1	1	1	1	1	1	0	0	0	0	0	0	0	0	0
	GREEN(255)	0	0	0	0	0	0	0	0	1	1	1	1	1	1	1	1	0	0	0	0	0	0	0	0
B	BLUE(000)	0	0	0	0	0	0	0	0	0	0	0	0	0	0	0	0	0	0	0	0	0	0	0	0
	BLUE(001)	0	0	0	0	0	0	0	0	0	0	0	0	0	0	0	0	0	0	0	0	0	0	0	1
	----																								
	BLUE(254)	0	0	0	0	0	0	0	0	0	0	0	0	0	0	0	0	1	1	1	1	1	1	1	0
	BLUE(255)	0	0	0	0	0	0	0	0	0	0	0	0	0	0	0	0	1	1	1	1	1	1	1	1

### 3.6 Power Sequence for LCD

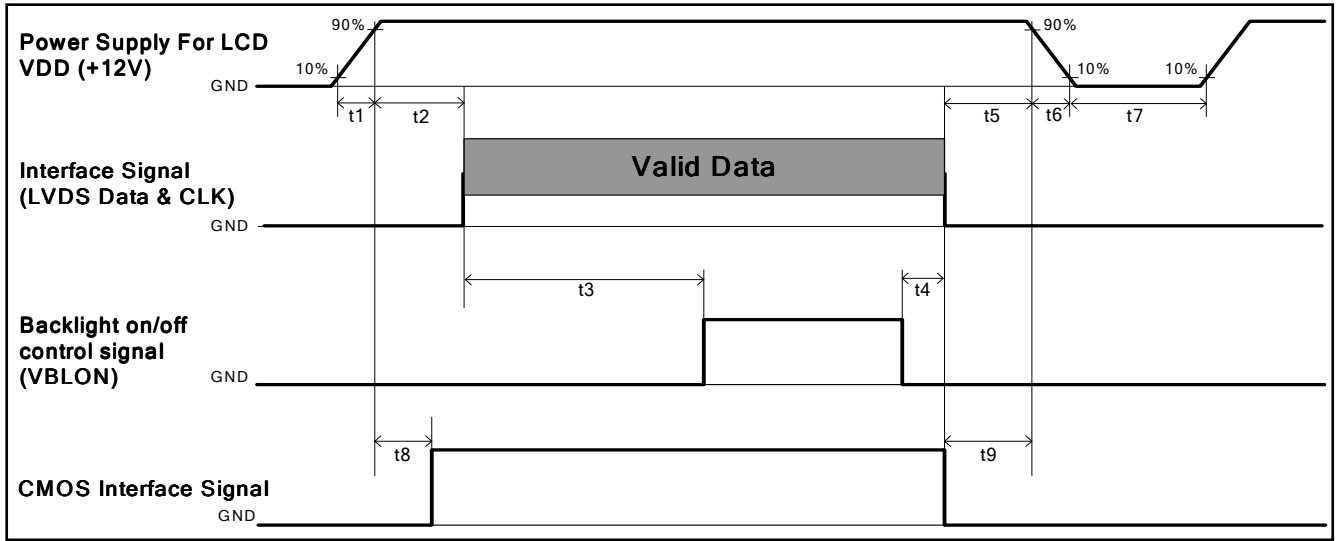

Parameter	Values			Unit
	Min.	Type.	Max.	
t1	0.4	---	30	ms
t2	0.1	---	50	ms
t3	450	---	---	ms
t4	0 <sup>*1</sup>	---	---	ms
t5	0	---	---	ms
t6	---	---	--- <sup>*2</sup>	ms
t7	500	---	---	ms
t8	10	---	50	ms
t9	0	---	---	ms

Note:

- (1) T4=0 : concern for residual pattern before BLU turn off.
- (2) T6 : voltage of VDD must decay smoothly after power-off. (customer system decide this value)

### 3.7 Backlight Specification

The backlight unit contains 3-U type CCFLs (Cold Cathode Fluorescent Lamp)

#### Electrical specification (Recommended)

Item	Symbol	Condition	Spec			Unit	Note
			Min.	Typ.	Max.		
Operating Voltage	Vo	-	920	1020	1120	[ Vrms ]	-
Operating Current	Io	-	14.5	15	15.5	[ mArms ]	-
BL Total Power Dissipation	PBL	-	-	50	-	[ Watt ]	-
Striking Voltage	Vstk	At 0°C	2300	-	-	[ Vrms ]	-
		At 25°C	2000	-	-		
Striking Time	Ts	-	1000	-	1500	[ msec ]	-
Operating Frequency	fo	-	53	55	57	[ kHz ]	-
PWM Operating Frequency	F_PWM	-	140	180	240	[ Hz ]	-
PWM Dimming Duty Ratio	D_PWM	-	10	-	100	[ % ]	Note 1&2
Lamp Type			U type			-	-
Number of Lamps			3			[ PC ]	-

( Ta=25±5°C , Turn on for 45minutes )

**Note 1:** Dimming range



PWM Dimming : include Internal and External PWM Dimming

**Note 2:** Low dimming ratio operation

When PWM dimming duty ratio is operated lower than recommended value, feedback signal and all protection functions should be confirmed by LIPS design. Display performance should also be confirmed by customer's implement.

**Lamp specification**

Item	Symbol	Condition	Spec			Unit	Note
			Min.	Typ.	Max.		
Lamp voltage	VL	-	910	1010	1110	[ Vrms ]	-
Lamp current	IL	-		15.0	15.5	[ mArms ]	-
Lamp frequency	fL	-	40	-	80	[ kHz ]	-
Starting voltage	Vs	At 0°C	-	-	2200	[ Vrms ]	-
		At 25°C	-	-	1900	[ Vrms ]	-
Delayed discharge time	TD	-	-	-	1.0	[ sec ]	-
Life time	TL	-	30K	-	-	[ hr ]	-
Unsymmetrical ratio	UR	-	-	-	10%	-	1
Crest factor	C.F.	-	$\sqrt{2} - 10\%$	$\sqrt{2}$	$\sqrt{2} + 10\%$	-	

The above characteristics are measured under the conditions:  
Ambient temperature: 25±2°C, Relative Humidity: 65±20%RH.

**Note 1: Waveform definition**

Please light on the lamp with symmetrical voltage and current waveform (unsymmetrical ratio is less than 10%, crest factor within  $\sqrt{2} \pm 10\%$  ).

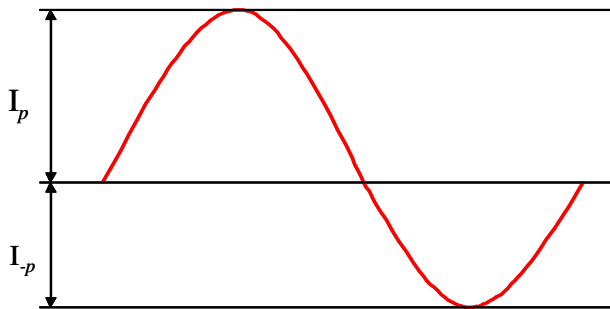

Unsymmetrical Ratio =  $|I_p - I_{-p}| / I_{rms} * 100\%$

Crest Factor =  $I_p$  (or  $I_{-p}$ ) /  $I_{rms}$

$I_p$  : High side peak value

$I_{-p}$  : Low side peak value

$I_{rms}$  : Root mean square value

## 4. Optical Specification

Optical characteristics are determined after the unit has been 'ON' and stable for approximately 45 minutes in a dark environment at 25°C. The values specified are at an approximate distance 50cm from the LCD surface at a



viewing angle of  $\phi$  and  $\theta$  equal to  $0^\circ$ .

**Fig.1 presents additional information concerning the measurement equipment and method.**

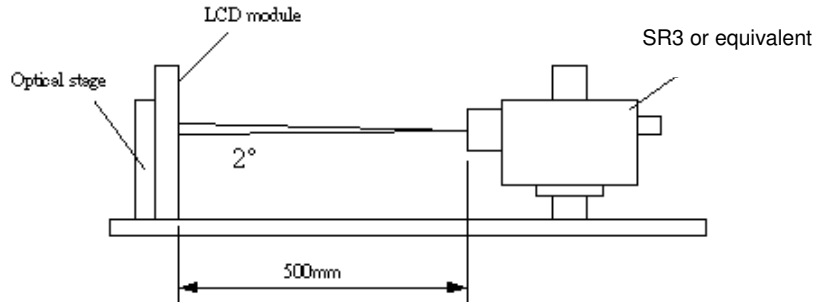

Parameter	Symbol	Values			Unit	Notes
		Min.	Typ.	Max		
Contrast Ratio	CR	1200	2000	--		1
Surface Luminance (White)	$L_{WH}$	250	300	--	$cd/m^2$	2
Luminance Variation	$\delta_{WHITE(SP)}$	--	--	1.33		3
Response Time (G to G)	$T_\gamma$	--	6.5	13	Ms	4
Color Gamut	NTSC		72		%	
Color Coordinates						
	Red	$R_x$	Typ.-0.03	0.65	Typ.+0.03	
		$R_y$		0.33		
	Green	$G_x$		0.29		
		$G_y$		0.61		
	Blue	$B_x$		0.15		
		$B_y$		0.05		
	White	$W_x$		0.28		
	$W_y$	0.29				
Viewing Angle						
	x axis, right( $\phi=0^\circ$ )	$\theta_r$	--	89	--	degree
	x axis, left( $\phi=180^\circ$ )	$\theta_l$	--	89	--	degree
	y axis, up( $\phi=90^\circ$ )	$\theta_u$	--	89	--	degree
	y axis, down ( $\phi=270^\circ$ )	$\theta_d$	--	89	--	degree

Note:

1. Contrast Ratio (CR) is defined mathematically as:

$$\text{Surface Luminance of } L_{on5}$$

**Contrast Ratio= Surface Luminance of  $L_{off5}$**

- Surface luminance is luminance value at point 5 across the LCD surface 50cm from the surface with all pixels displaying white. From more information see FIG 2.
- The variation in surface luminance,  $\delta_{WHITE}$  is defined (center of Screen) as:  

$$\delta_{WHITE(9P)} = \text{Maximum}(L_{on1}, L_{on2}, \dots, L_{on9}) / \text{Minimum}(L_{on1}, L_{on2}, \dots, L_{on9})$$
- Response time  $T_{\gamma}$  is the average time required for display transition by switching the input signal for five luminance ratio (0%,25%,50%,75%,100% brightness matrix) and is based on  $F_v=60\text{Hz}$  to optimize.

Measured Response Time		Target				
		0%	25%	50%	75%	100%
Start	0%		0% to 25%	0% to 50%	0% to 75%	0% to 100%
	25%	25% to 0%		25% to 50%	25% to 75%	25% to 100%
	50%	50% to 0%	50% to 25%		50% to 75%	50% to 100%
	75%	75% to 0%	75% to 25%	75% to 50%		75% to 100%
	100%	100% to 0%	100% to 25%	100% to 50%	100% to 75%	

The response time is defined as the following figure and shall be measured by switching the input signal for “any level of gray(bright) “ and “any level of gray(dark)”.

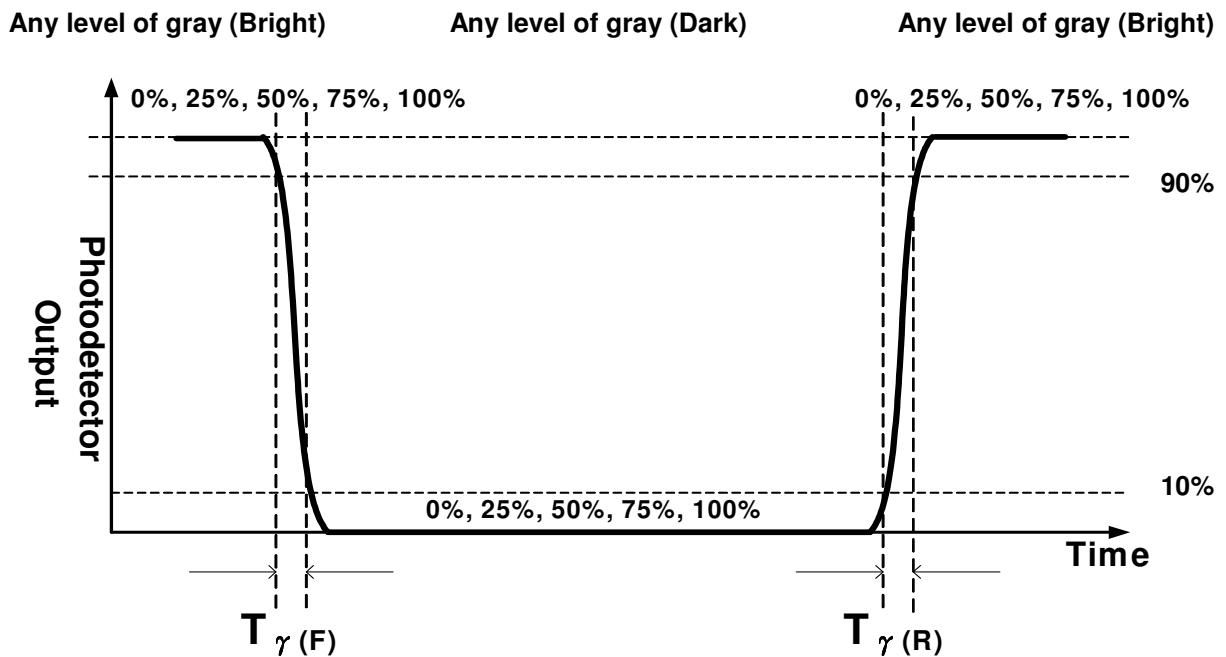

- Viewing angle is the angle at which the contrast ratio is greater than 10. The angles are determined for the horizontal or x axis and the vertical or y axis with respect to the z axis which is normal to the LCD surface. For more information see FIG3.

**FIG. 2 Luminance**

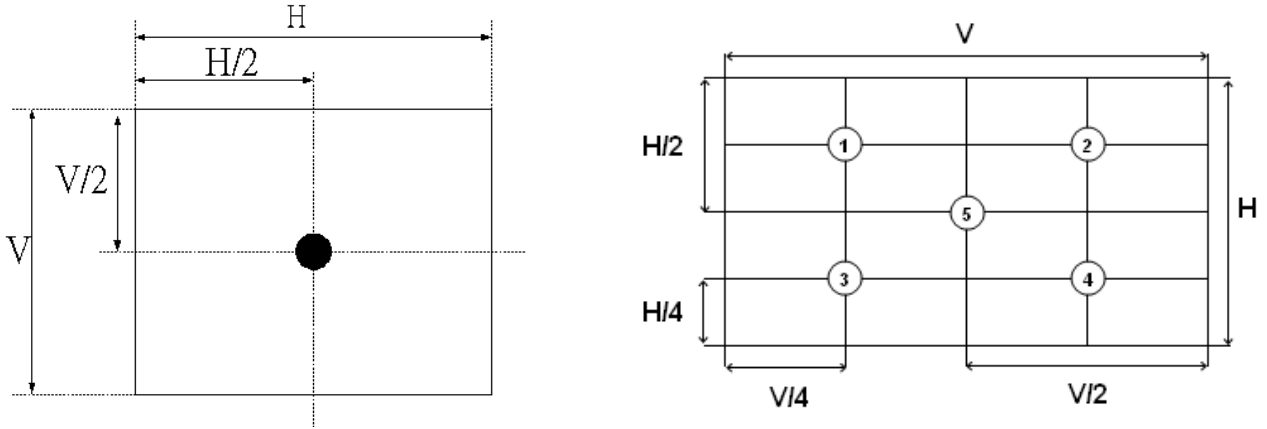
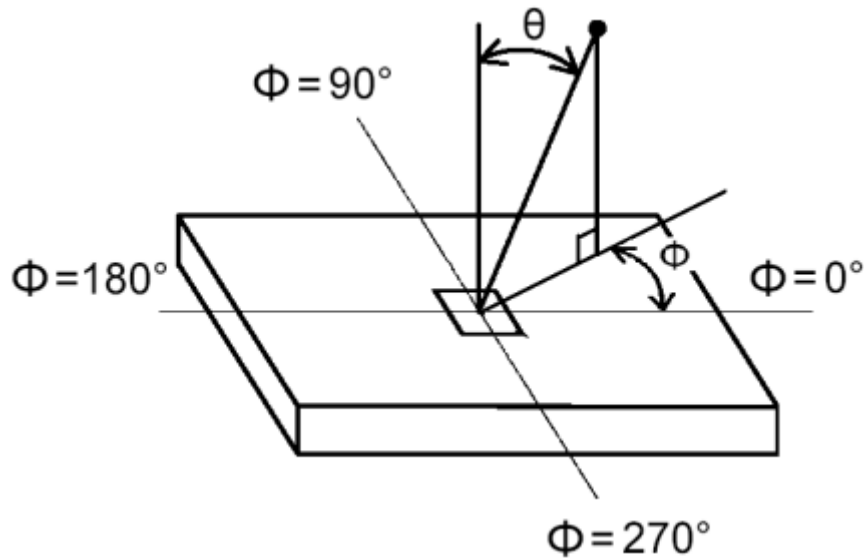

FIG.3 Viewing Angle



## 5. Mechanical Characteristics

The contents provide general mechanical characteristics for the model T240XVN01.0. In addition the figures in the next page are detailed mechanical drawing of the LCD.

Outline Dimension	Horizontal	580.0 mm
	Vertical	347.5 mm
	Depth	46.7mm
Bezel Opening	Horizontal	536.1 mm
	Vertical	303.3mm
Active Display Area	Horizontal	531.72mm
	Vertical	298.94 mm
Weight	2300g (Typ.)	
Surface Treatment	Anti-Glare, 3H	

**Front View**

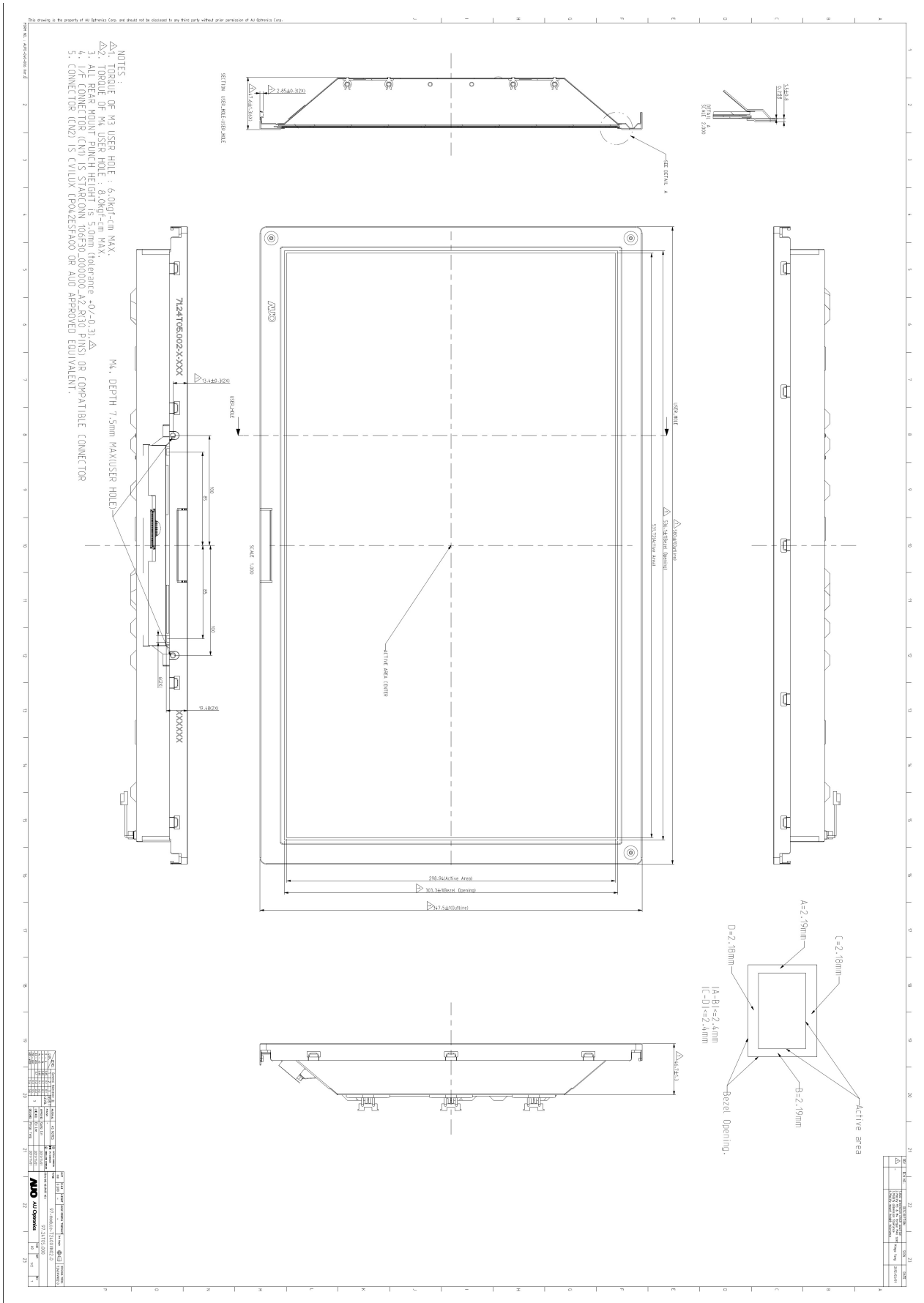

**Back View**

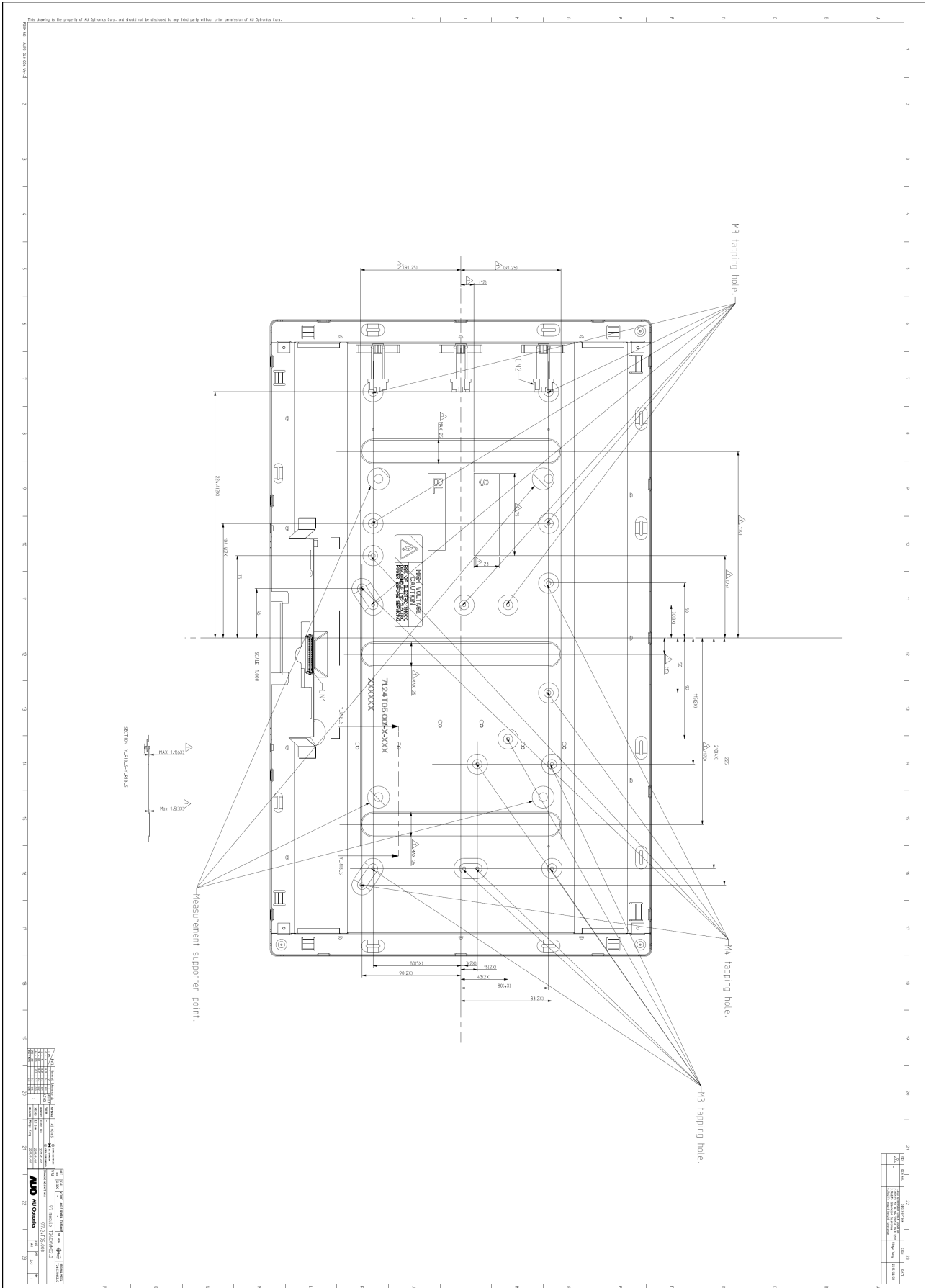

## 6. Reliability Test Items

	Test Item	Q'ty	Condition
1	High temperature storage test	3	60°C , 300hrs
2	Low temperature storage test	3	-20°C , 300hrs
3	High temperature operation test	3	50°C , 300hrs
4	Low temperature operation test	3	-5°C , 300hrs
5	Vibration test (non-operation)	3	Wave form: random Vibration level: 1.5G RMS Bandwidth: 10-300Hz, Duration: X, Y, Z 30min/axis One time each direction
6	Shock test (non-operation)	3	Shock level: 50G Waveform: half sine wave, 11ms Direction: ±X, ±Y, ±Z, One time each direction
7	Vibration test (With carton)	5	Random wave (1.5GRMS, 10-200Hz) 30mins/ Per each X,Y,Z axes
8	Drop test (With carton)	5	Height: 533 mm 1 corner, 3 edges, 6 faces (ASTMD5276)

## **7. International Standard**

### **7.1 Safety**

- (1) UL 60950-1, UL 60065; Standard for Safety of Information Technology Equipment Including electrical Business Equipment.
- (2) IEC 60950-1 : 2001, IEC 60065:2001 ; Standard for Safety of International Electrotechnical Commission
- (3) EN 60950 : 2001+A11, EN 60065:2002+A1:2006; European Committee for Electrotechnical Standardization (CENELEC), EUROPEAN STANDARD for Safety of Information Technology Equipment Including Electrical Business Equipment.

### **7.2 EMC**

- (1) ANSI C63.4 “Methods of Measurement of Radio-Noise Emissions from Low-Voltage Electrical and Electrical Equipment in the Range of 9kHz to 40GHz. “American National standards Institute(ANSI), 1992
- (2) C.I.S.P.R “Limits and Methods of Measurement of Radio Interface Characteristics of Information Technology Equipment.” International Special committee on Radio Interference.
- (3) EN 55022 “Limits and Methods of Measurement of Radio Interface Characteristics of Information Technology Equipment.” European Committee for Electrotechnical Standardization. (CENELEC), 1998



## 8. Packing

### 8-1 DEFINITION OF LABEL:

#### A. Panel Label:



#### Green mark description

- (1) For Pb Free Product, AUO will add for identification.
  - (2) For RoHs compatible products, AUO will add for identification.
- Note: The green Mark will be present only when the green documents have been ready by AUO internal green team. (definition of green design follows the AUO green design checklist.)

#### B. Carton Label:

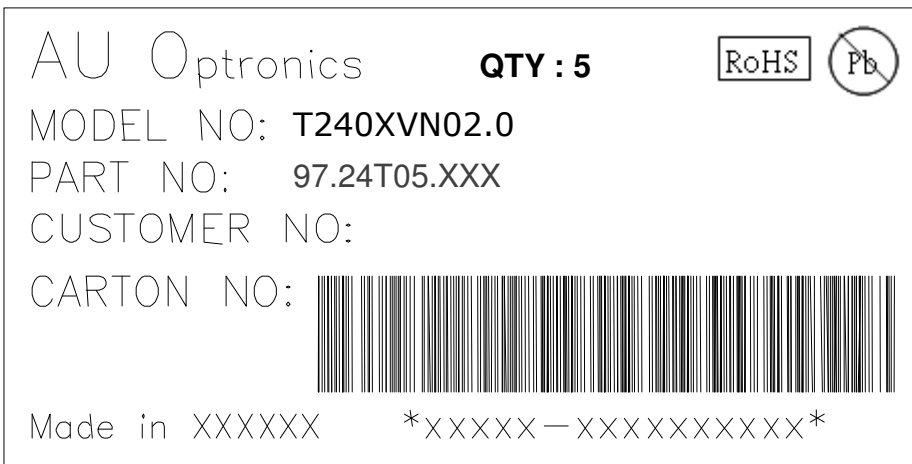

**8-2 PACKING METHODS:**

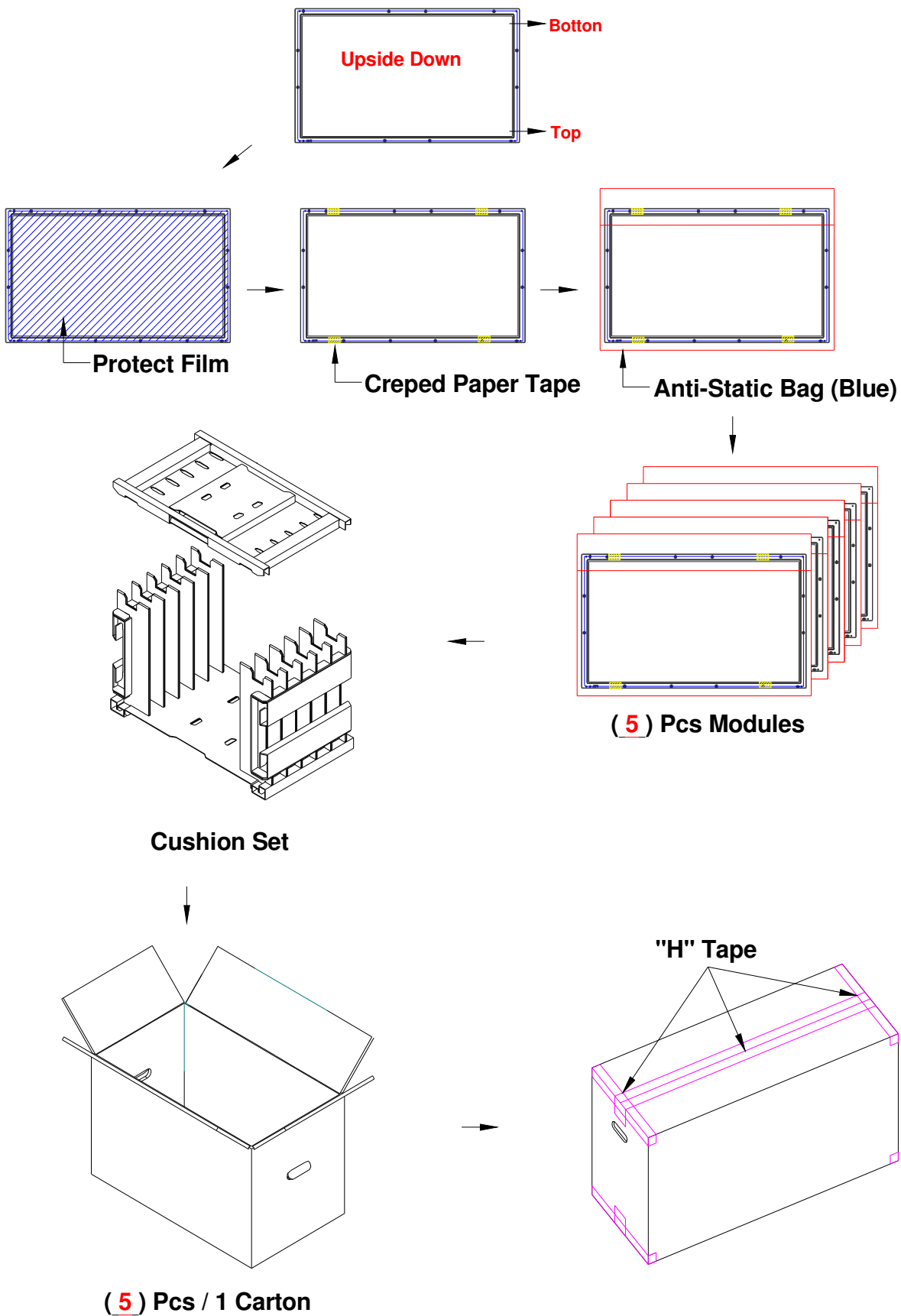

**8-3 Pallet and Shipment Information**

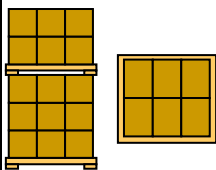
	Item	Specification			Packing Remark
		Qty.	Dimension	Weight (kg)	
1	Packing BOX	5	640(L) x 381(W) x 434(H) mm	14kg	Total Weight
2	Pallet	1	1315(L) x 1150(W) x 132(H) mm	17.7kg	
3	Boxes per Pallet	A. 12 Boxes / Pallet (Upper Layer) B. 18 Boxes / Pallet (Bottom Layer)			 (40ft HQ)
4	Panels per Pallet	60Pcs / Pallet			Upper Layer
		90 Pcs / Pallet			Bottom Layer
5	Pallet after packing	1315(L) x 1150(W) x 984(H) mm		185.7 kg	Upper Layer
		1315(L) x 1150(W) x 1410(H) mm		269.7 kg	Bottom Layer

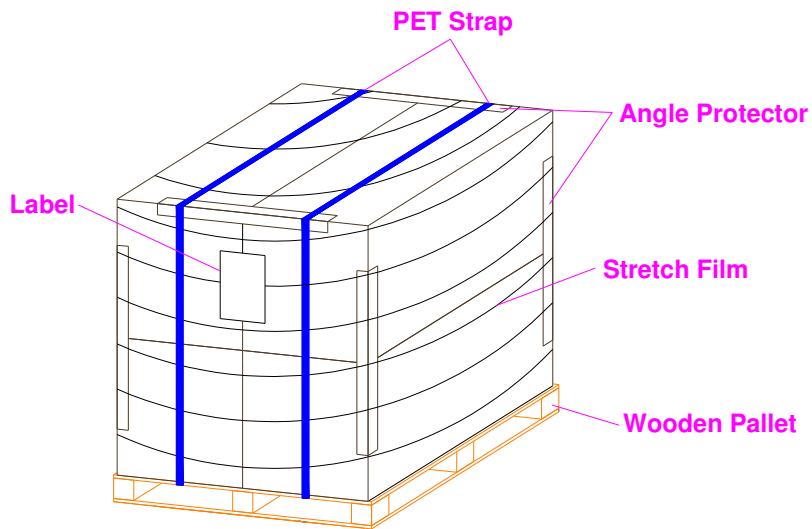

## 9. PRECAUTIONS

Please pay attention to the followings when you use this TFT LCD module.

### 9-1 MOUNTING PRECAUTIONS

- (1) You must mount a module using holes arranged in four corners or four sides.
- (2) You should consider the mounting structure so that uneven force (ex. twisted stress) is not applied to module. And the case on which a module is mounted should have sufficient strength so that external force is not transmitted directly to the module.
- (3) Please attach the surface transparent protective plate to the surface in order to protect the polarizer. Transparent protective plate should have sufficient strength in order to resist external force.
- (4) You should adopt radiation structure to satisfy the temperature specification.
- (5) Acetic acid type and chlorine type materials for the cover case are not desirable because the former generates corrosive gas of attacking the polarizer at high temperature and the latter cause circuit broken by electro-chemical reaction.
- (6) Do not touch, push or rub the exposed polarizer with glass, tweezers or anything harder than HB pencil lead. And please do not rub with dust clothes with chemical treatment. Do not touch the surface of polarizer for bare hand or greasy cloth. (Some cosmetics are detrimental to the polarizer.)
- (7) When the surface becomes dusty, please wipe gently with absorbent cotton or other soft materials like chamois soaks with petroleum benzene. Normal-hexane is recommended for cleaning the adhesives used to attach front/ rear polarizer. Do not use acetone, toluene and alcohol because they cause chemical damage to the polarizer.
- (8) Wipe off saliva or water drops as soon as possible. Their long time contact with polarizer causes deformations and color fading.
- (9) Do not open the case because inside circuits do not have sufficient strength.

### 9-2 OPERATING PRECAUTIONS

- (1) The device listed in the product specification sheets was designed and manufactured for TV application
- (2) The spike noise causes the mis-operation of circuits. It should be lower than following voltage:  
 $V = \pm 200\text{mV}$  (Over and under shoot voltage)
- (3) Response time depends on the temperature. (In lower temperature, it becomes longer..)
- (4) Brightness depends on the temperature. (In lower temperature, it becomes lower.) And in lower temperature, response time (required time that brightness is stable after turned on) becomes longer.
- (5) Be careful for condensation at sudden temperature change. Condensation makes damage to polarizer or electrical contacted parts. And after fading condensation, smear or spot will occur.
- (6) When fixed patterns are displayed for a long time, remnant image is likely to occur.
- (7) Module has high frequency circuits. Sufficient suppression to the electromagnetic interference shall be done by system manufacturers. Grounding and shielding methods may be important to minimize

the interface.

### **9-3 ELECTROSTATIC DISCHARGE CONTROL**

Since a module is composed of electronic circuits, it is not strong to electrostatic discharge. Make certain that treatment persons are connected to ground through wristband etc. And don't touch interface pin directly.

### **9-4 PRECAUTIONS FOR STRONG LIGHT EXPOSURE**

Strong light exposure causes degradation of polarizer and color filter.

### **9-5 STORAGE**

When storing modules as spares for a long time, the following precautions are necessary.

- (1) Store them in a dark place. Do not expose the module to sunlight or fluorescent light. Keep the temperature between 5°C and 35°C at normal humidity.
- (2) The polarizer surface should not come in contact with any other object. It is recommended that they be stored in the container in which they were shipped.

### **9-6 HANDLING PRECAUTIONS FOR PROTECTION FILM**

- (1) The protection film is attached to the bezel with a small masking tape. When the protection film is peeled off, static electricity is generated between the film and polarizer. This should be peeled off slowly and carefully by people who are electrically grounded and with well ion-blown equipment or in such a condition, etc.
- (2) When the module with protection film attached is stored for a long time, sometimes there remains a very small amount of glue still on the bezel after the protection film is peeled off.
- (3) You can remove the glue easily. When the glue remains on the bezel or its vestige is recognized, please wipe them off with absorbent cotton waste or other soft material like chamois soaked with normal-hexane.