



Product Description: T260XW02_V8 TFT-LCD PANEL

AUO Model Name: T260XW02 V8

Customer Part No/Project Name:

Customer Signature	Date	AUO	Date
		Approved By: PL Chen	
		Reviewed By: Hong Jye Hong	
		Prepared By: Eric Chiang	



Document Version: 0.6

Date: 2006/8/1

Product Specifications

26.0" WXGA Color TFT-LCD Module
Model Name: T260XW02

() Preliminary Specifications
(* Final Specifications



Contents

No	ITEM
	COVER
	CONTENTS
	RECORD OF REVISIONS
1	GENERAL DESCRIPTION
2	ABSOLUTION MAXIMUM RATINGS
3	ELECTRICAL SPECIFICATIONS
3-1	ELECTRICAL CHARACTERISTICS
3-2	INTERFACE CONNECTIONS
3-3	SIGNAL TIMING SPECIFICATIONS
3-4	SIGNAL TIMING WAVEFORMS
3-5	COLOR INPUT DATA REFERENCE
3-6	POWER SEQUENCE for LCD
3-7	POWER SEQUENCE for INVERTER
4	OPTICAL SPECIFICATIONS
5	MECHANICAL CHARACTERISTICS
6	RELIABILITY
7	INTERNATIONAL STANDARDS
7-1	SAFETY
7-2	EMC
7-3	Green
8	PACKING
9	PRECAUTIONS

www.goodpanel.net



Record of Revision

Version	Date	No	Old Description	New Description	Remark
0.1	5/24/2006			1. Add "Global code Parts Number (L5EDD6Q00017)" and "Issue Number (L20060186)" 2. Add panel surface temperature (max=65°C) 3. 2D drawing update 4. Add shipping label description	Cover page P.5 P.20,21 P.24
0.2	5/29/2006		1. Wooden pallet	1. Paper pallet	P.26
0.3	6/5/2006			1. Adopt Panasonic's format 2. 2D drawing update 3. RA condition modify	Cover page P.21,22 P.22
0.4	6/8/2006			1. Page number modify 2. Remove note 3 3. Shipping label description update 4. Image sticking description update	P.5 P.24 P.23
0.5	6/9/2006			1. Correct product description 2. Remove LVDS transmitter 3. Add heat shock	Cover page P.7 P.23
0.6	6/12/2006			1. Add min value of brightness and contrast ratio 2. Modify mylar dimension	P. 17 P.21

液晶仓库
www.goodpanel.net



1. General Description

This specification applies to the 26.0 inch Color TFT-LCD Module T260XW02. This LCD module has a TFT active matrix type liquid crystal panel 1366x768 pixels, and diagonal size of 26.0 inch. This module supports 1366x768 XGA-WIDE mode (Non-interlace).

Each pixel is divided into Red, Green and Blue sub-pixels or dots which are arranged in vertical stripes. Gray scale or the brightness of the sub-pixel color is determined with a 8-bit gray scale signal for each dot.

The T260XW02 has been designed to apply the 8-bit 1 channel LVDS interface method. It is intended to support displays where high brightness, wide viewing angle, high color saturation, and high color depth are very important.

* General Information

Items	Specification	Unit	Note
Active Screen Size	26.0	inches	
Display Area	575.769 (H) x 323.712(V)	mm	
Pixel Pitch	0.4215	mm	
Outline Dimension	626.0 (H) x 373.0 (V) x 47.5(D)	mm	With inverter
Driver Element	a-Si TFT active matrix		
Display Colors	16.7M	Colors	
Number of Pixels	1366 x 768	Pixel	
Pixel Arrangement	RGB vertical stripe		
Display Mode	Normally Black		
BL Structure	8 U-Lamps		
Surface Treatment	AG, 3H		
Green	RoHS compliance		

www.goodpanel.net

2. Absolute Maximum Ratings

The following are maximum values which, if exceeded, may cause faulty operation or damage to the unit.

Item	Symbol	Min	Max	Unit	Conditions
Logic/LCD Drive Voltage	V _{CC}	-0.3	6.0	[Volt]	Note 1
LVDS Option Control Voltage	V _{LVDSOPT}	-0.3	3.6	[Volt]	Note 1
BLU Input Voltage	V _{DDB}	-0.3	27.0	[Volt]	Note 1
BLU Brightness Control Voltage	BLON	-0.3	7.0	[Volt]	Note 1
External Analog Dimming Control Voltage	VDIM	-0.3	6.0	[Volt]	Note 1
On/Off Control Voltage	V _{BLON}	-0.3	6.0	[Volt]	Note 1
External PWM Dimming Control Voltage	EV _{PWM}	-0.3	6.0	[Volt]	Note 1
Operating Temperature	TOP	0	+50	[°C]	Note 2
Operating Humidity	HOP	10	90	[%RH]	Note 2
Storage Temperature	TST	-20	+60	[°C]	Note 2
Storage Humidity	HST	10	90	[%RH]	Note 2
Panel Surface Temperature			65	[°C]	

Note 1: Duration = 1 sec

Note 2: Maximum Wet-Bulb should be 39°C and No condensation.

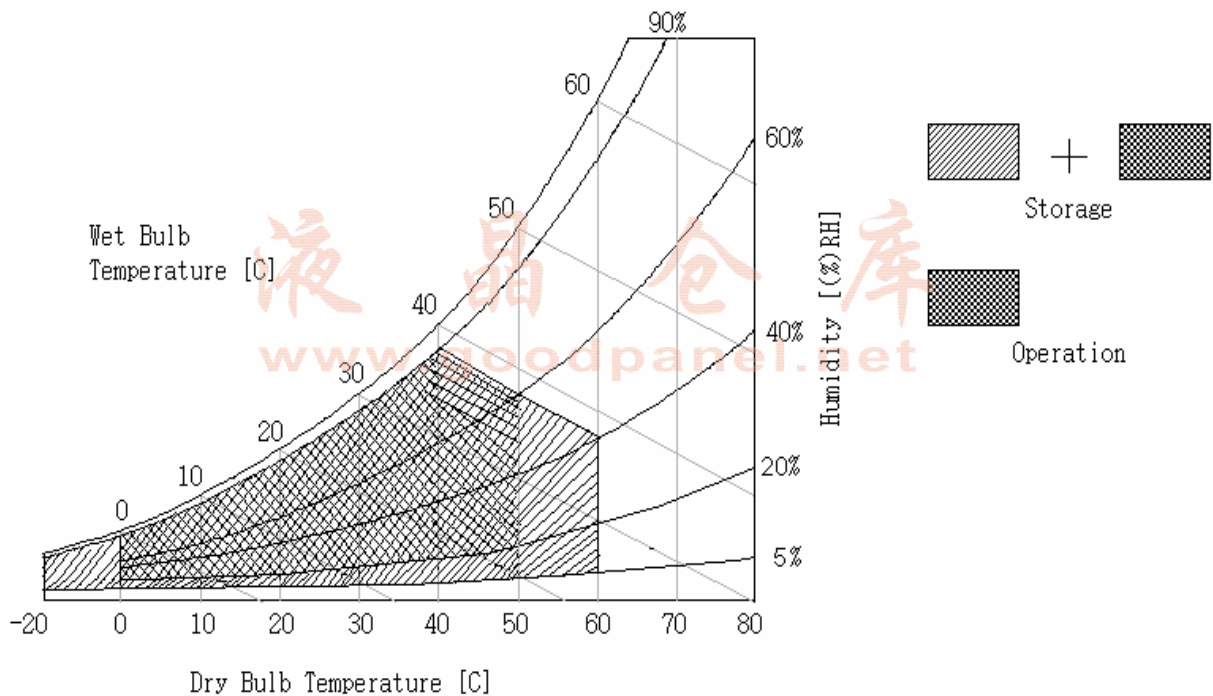



3. Electrical Specification

The T260XW02 requires two power inputs. One is employed to power the LCD electronics and to drive the TFT array and liquid crystal. The second input power for the BLU, is to power inverter..

3-1 Electrical Characteristics

Parameter	Symbol	Values			Unit	Notes
		Min.	Typ.	Max.		
LCD:						
Power Supply Input Voltage	V _{cc}	4.5	5.0	5.5	V	
Power Supply Input Current	I _{cc}	-	1.40	1.78	A	1
Power Consumption	P _c	-	7.0	9.0	Watt	1
Inrush Current	I _{RUSH}	-	-	5.0	A	2
Backlight Power Consumption	PDDB	-	-	94.8	Watt	3
Life Time		50,000	60,000		Hours	4

Note :

1. V_{cc}=5.0V, F_v=60Hz, F_{Dclk}= 85.0 MHz , 25°C . , Test Pattern : White Pattern
2. V_{cc} rising time = 470 *ms* , V_{cc}=5.0V
3. Refer to page 11
4. The performance of the Lamp in LCM, for example: lifetime or brightness, is extremely influenced by the characteristics of the DC-AC Inverter. So all the parameters of an inverter should be carefully designed so as not to produce too much leakage current from high-voltage output of the inverter. When you design or order the inverter, please make sure unwanted lighting caused by the mismatch of the lamp and the inverter (no lighting, flicker, etc) never occurs. When you confirm it, the LCD Assembly should be operated in the same condition as installed in your instrument.
5. Do not attach a conducting tape to lamp connecting wire. If the lamp wire attach to conducting tape, TFT-LCD Module have a low luminance and the inverter has abnormal action because leakage current occurs between lamp wire and conducting tape.
6. The relative humidity must not exceed 80% non-condensing at temperatures of 40°C or less. At temperatures greater than 40°C, the wet bulb temperature must not exceed 39°C. When operate at low temperatures, the brightness of CCFL will drop and the lifetime of CCFL will be reduced.



3-2 Interface Connections

- LCD connector (CN1): JAE FI-E30S

Interface pin definition

Pin No	Symbol	Description	Default
1	N.C.	No Connection (Auo internal Test Pin)	
2	N.C.	No Connection (Auo internal Test Pin)	
3	N.C.	No Connection (Auo internal Test Pin)	
4	GND	Power Ground	
5	RIN0-	Negative LVDS differential data input	
6	RIN0+	Positive LVDS differential data input	
7	GND	Power Ground	
8	RIN1-	Negative LVDS differential data input	
9	RIN1+	Positive LVDS differential data input	
10	GND	Power Ground	
11	RIN2-	Negative LVDS differential data input	
12	RIN2+	Positive LVDS differential data input	
13	GND	Power Ground	
14	RxCLK-	Negative LVDS differential clock input	
15	RxCLK+	Positive LVDS differential clock input	
16	GND	Power Ground	
17	Rx3-	Negative LVDS differential data input	
18	Rx3+	Positive LVDS differential data input	
19	GND	Power Ground	
20	N.C.	No Connection (Auo internal Test Pin)	
21	LVDS Option	Pull Low : JETDA LVDS format; Pull High or N.C.: NS LVDS format	
22	N.C.	No Connection (Auo internal Test Pin)	
23	GND	Power Ground	
24	GND	Power Ground	
25	GND	Power Ground	
26	V _{CC}	+5V Power Input	
27	V _{CC}	+5V Power Input	
28	V _{CC}	+5V Power Input	
29	V _{CC}	+5V Power Input	
30	V _{CC}	+5V Power Input	

Note

All GND (ground) pins should be connected together and should also be connected to the LCD's metal frame. All Vcc (power input) pins should be connected together.



LVDS Option = L (GND) è JETDA Format

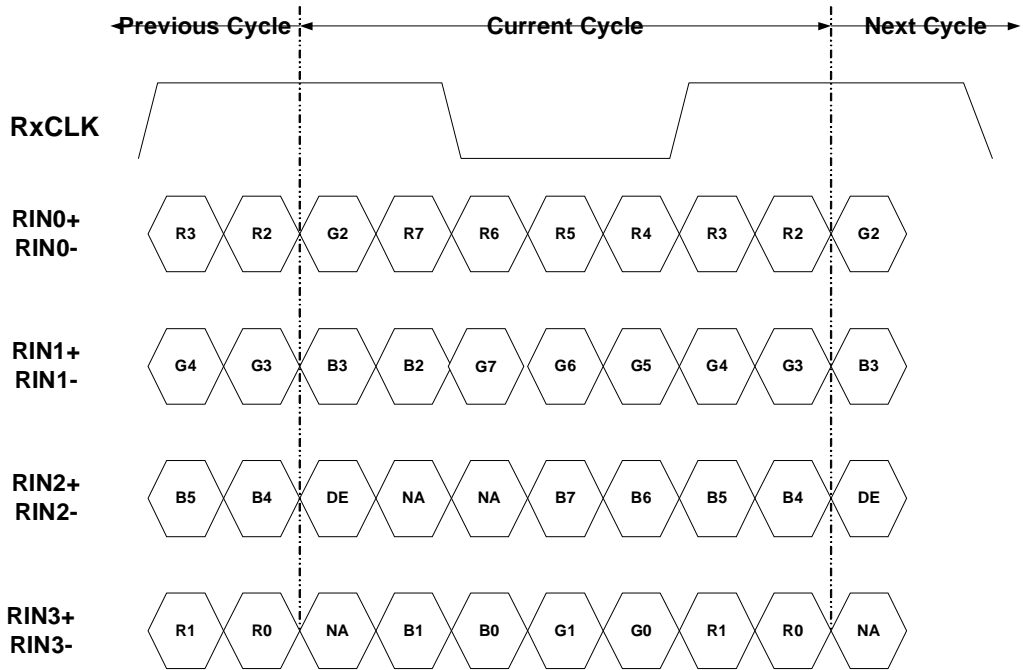

LVDS Option = H (3.3V) or N.C. è NS Format

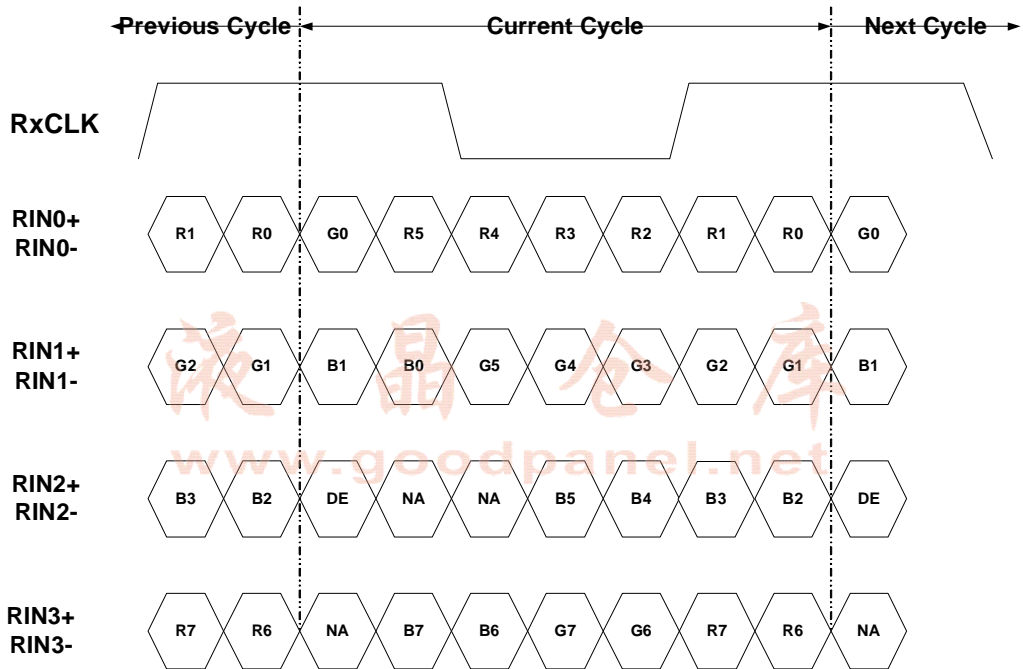



BACKLIGHT CONNECTOR PIN CONFIGURATION

1. Electrical specification

(Ta=25±5°C)

No	ITEM	SYMBOL	CONDITION	MIN	TYP	MAX	UNIT	Note	
1	Input Voltage	V_{DDB}	---	21.6	24.0	26.4	V		
2	Input Current (Turn on Condition)	I_{DDB}	$V_{DDB}=24V$ $V_{DIM}=3.3V$ $EDPWM=100$ %	---	3.65	3.95	A	1	
3	Input Power (Turn on Condition)	P_{DDB}	$V_{DDB}=24V$ $V_{DIM}=3.3V$ $EDPWM=100\%$	---	87.6	94.8	W	1	
4	Input Current (Stable Condition)	I_{DDB}	$V_{DDB}=24V$ $V_{DIM}=3.3V$ $EDPWM=100\%$	---	3.5	3.6	A	1	
5	Input Power (Stable Condition)	P_{DDB}	$V_{DDB}=24V$ $V_{DIM}=3.3V$ $EDPWM=100\%$	---	84	87	W	1	
6	Input inrush current, 0.3ms	I_{RUSH}	$V_{DD}=24V$ $V_{DIM}=3.3V$ $EDPWM=100\%$.	---	---	5.0	A		
7	Output Frequency	F_{BL}	$V_{DD}=24V$	55	58	61	kHz		
8	ON/OFF Control Voltage	V_{BLON}	ON	$V_{DD}=24V$	2.0	---	5.0	V	
			OFF	$V_{DD}=24V$	0.0	---	0.8	V	or Open
9	ON/OFF Control Current	I_{BLON}	$V_{DD}=24V$	--	---	1.5	mA		
10	Dimming Control Voltage	V_{DIM}	MAX	$V_{DD}=24V$	---	3.3	---	V	or Open
			MIN	$V_{DD}=24V$	---	0.0	---	V	
11	Dimming Control Current	I_{DIM}	$V_{DD}=24V$	---	---	1.5	mA		
12	External PWM Control Voltage	EV_{PWM}	MAX	---	2.0	---	5.0	V	
			MIN	---	-0.3	---	0.8	V	
13	External PWM Control Current	EI_{PWM}	MAX	PWM=100%	---	---	1.5	mA	
			MIN	PWM=100%	---	---	1.5	mA	
14	External PWM Duty Ratio	ED_{PWM}	---	30	---	100	%		
15	External PWM Frequency	EF_{PWM}	---	150	---	300	Hz		

Note1:

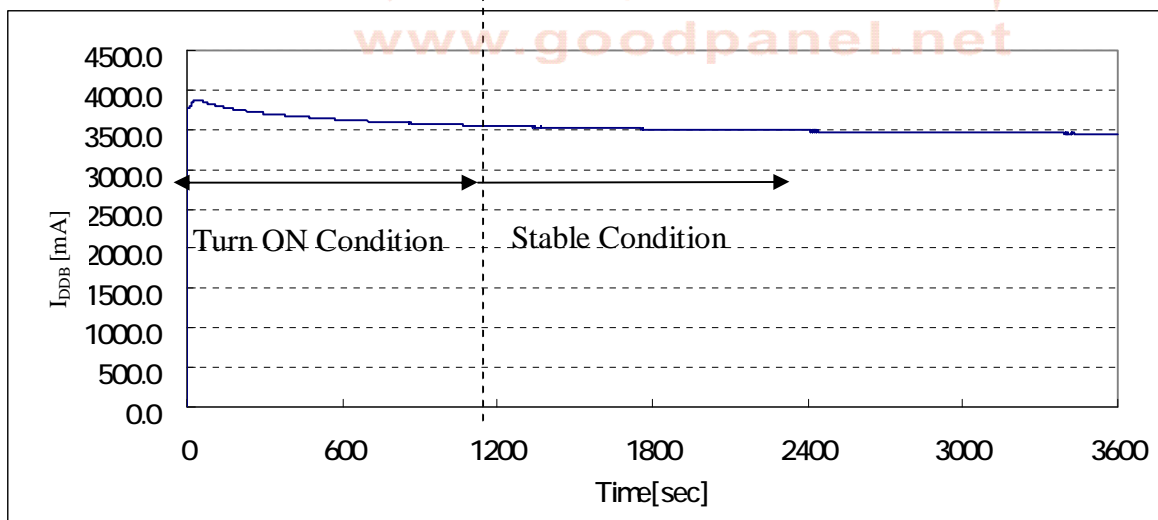

2. Input pin definition

Pin No	Symbol	Description	Default
1	VDDDB	Operating Voltage Supply, +24V DC regulated	24V
2	VDDDB	Operating Voltage Supply, +24V DC regulated	24V
3	VDDDB	Operating Voltage Supply, +24V DC regulated	24V
4	VDDDB	Operating Voltage Supply, +24V DC regulated	24V
5	VDDDB	Operating Voltage Supply, +24V DC regulated	24V
6	GND	Ground	GND
7	GND	Ground	GND
8	GND	Ground	GND
9	GND	Ground	GND
10	GND	Ground	GND
11	VDIM	External Analog Dimming Control	-
12	VBLON	On/Off Control	-
13	EXPWM	External PWM Dimming Control	-
14	N.C.	No Connection	-

CN1: J/CON 88289-1401 (ACES) or equivalent

CN3~10: 20015WR-NNL (Yenoho) or equivalent

3. Backlight Diagram

 **HOT: High Voltage**

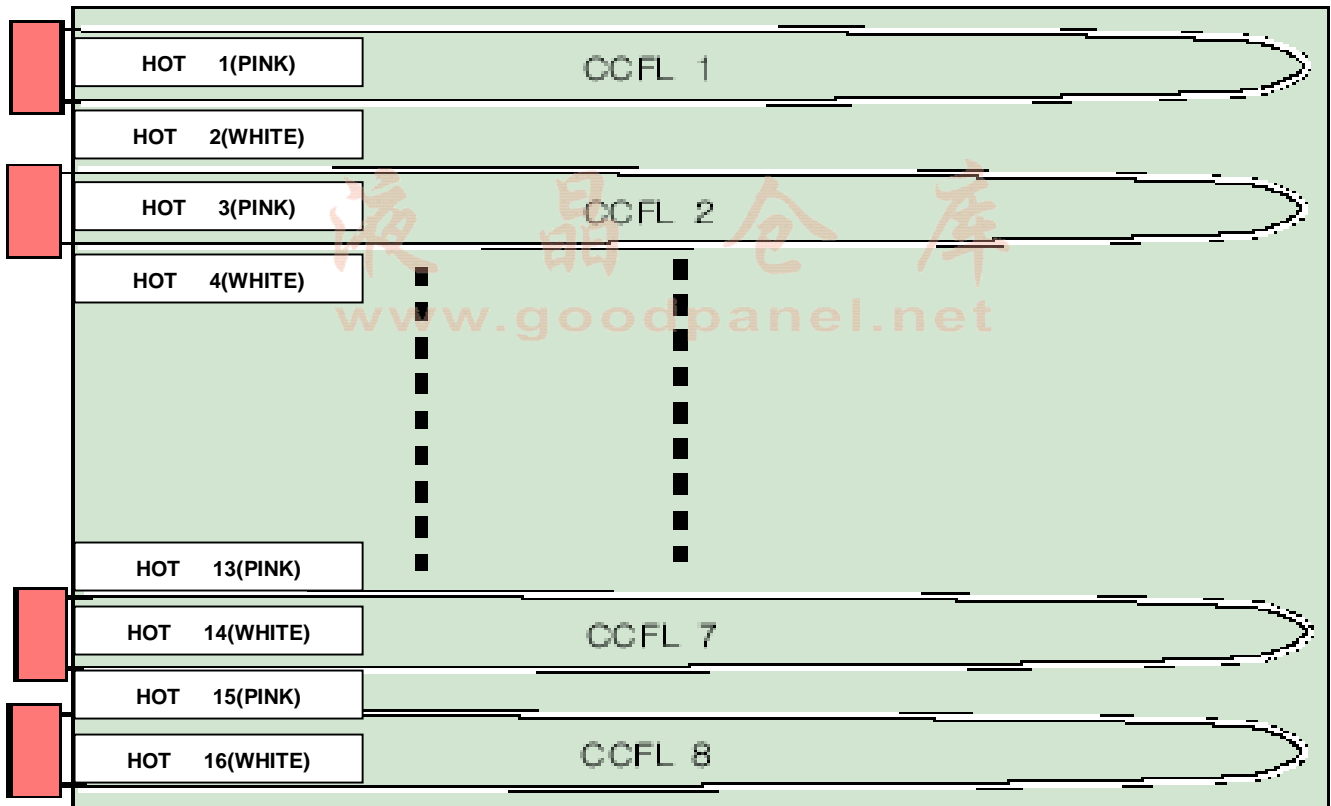



3-3 Signal Timing Specifications

This is the signal timing required at the input of the User connector. All of the interface signal timing should be satisfied with the following specifications for its proper operation.

* Timing Table

DE only Mode
Vertical Frequency

Signal	Item	Symbol	Min.	Typ.	Max.	Unit
Vertical Section	Period	Tv	784	806	1015	Th
	Active	Tdisp(v)	768			Th
	Blanking	Tblk (v)	16	38	247	Th
Horizontal Section	Period	Th	1414	1560	2000	Tclk
	Active	Tdisp(h)	1366			Tclk
	Blanking	Tblk (h)	48	194	634	Tclk
LVDS Clock	Frequency	F _{Dclk} (1/Tclk)	65	76	88	MHz
Vertical Frequency	Frequency	Fv	44	--	66	Hz
Horizontal Frequency	Frequency	Fh	40		53	kHz

1. Display position is specific by the rise of DE signal only.
2. Horizontal display position is specified by the rising edge of 1st Clock after the rise of DE, is displayed on the left edge of the screen.
3. Vertical display position is specified by the rise of DE after a “Low” level period equivalent to eight times of horizontal period. The 1st data corresponding to one horizontal line after the rise of DE is displayed at the top line of screen.
4. If a period of DE “High” is less than 1366 Clock or less than 768 lines, the rest of the screen displays black.
5. The display position does not fit to the screen if a period of DE “High” and the effective data period do not synchronize with each other.

液晶仓库
www.goodpanel.net

3-4 Signal Timing Waveforms

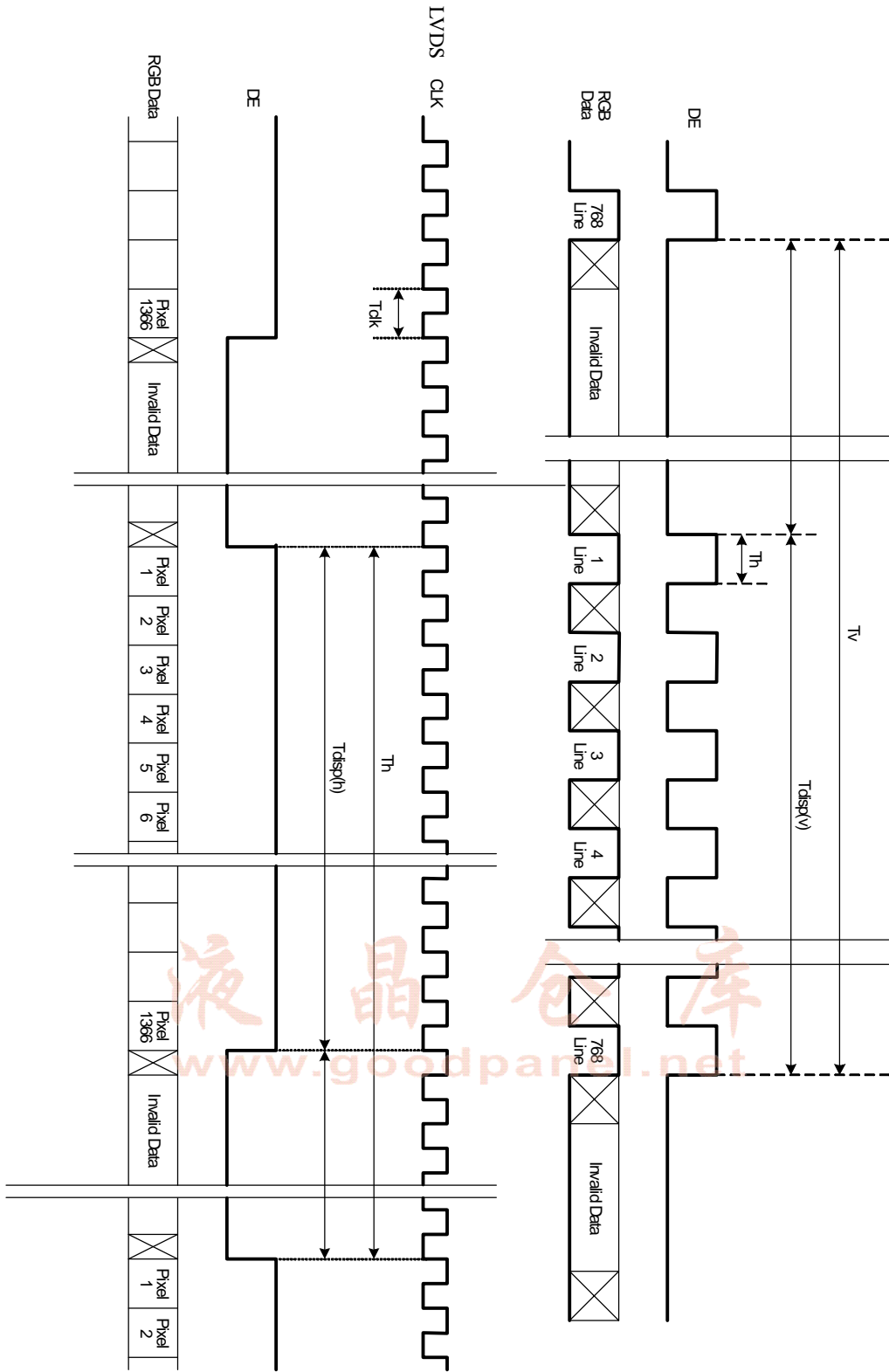



3-5 Color Input Data Reference

The brightness of each primary color (red, green and blue) is based on the 8 bit gray scale data input for the color; the higher the binary input, the brighter the color. The table below provides a reference for color versus data input.

COLOR DATA REFERENCE

Color		Input Color Data																							
		RED								GREEN								BLUE							
		MSB				LSB				MSB				LSB				MSB				LSB			
		R7	R6	R5	R4	R3	R2	R1	R0	G7	G6	G5	G4	G3	G2	G1	G0	B7	B6	B5	B4	B3	B2	B1	B0
Basic Color	BLACK(L0)	0	0	0	0	0	0	0	0	0	0	0	0	0	0	0	0	0	0	0	0	0	0	0	0
	RED(255)	1	1	1	1	1	1	1	1	0	0	0	0	0	0	0	0	0	0	0	0	0	0	0	0
	GREEN(255)	0	0	0	0	0	0	0	0	1	1	1	1	1	1	1	1	0	0	0	0	0	0	0	0
	BLUE(255)	0	0	0	0	0	0	0	0	0	0	0	0	0	0	0	0	1	1	1	1	1	1	1	1
	Cyan	0	0	0	0	0	0	0	0	1	1	1	1	1	1	1	1	1	1	1	1	1	1	1	1
	Magenta	1	1	1	1	1	1	1	1	0	0	0	0	0	0	0	0	1	1	1	1	1	1	1	1
	Yellow	1	1	1	1	1	1	1	1	1	1	1	1	1	1	1	1	0	0	0	0	0	0	0	0
	WHITE(L255)	1	1	1	1	1	1	1	1	1	1	1	1	1	1	1	1	1	1	1	1	1	1	1	1
RED	RED(000)	0	0	0	0	0	0	0	0	0	0	0	0	0	0	0	0	0	0	0	0	0	0	0	0
	RED(001)	0	0	0	0	0	0	0	1	0	0	0	0	0	0	0	0	0	0	0	0	0	0	0	0

	RED(254)	1	1	1	1	1	1	1	0	0	0	0	0	0	0	0	0	0	0	0	0	0	0	0	0
	RED(255)	1	1	1	1	1	1	1	1	0	0	0	0	0	0	0	0	0	0	0	0	0	0	0	0
GREEN	GREEN(000)	0	0	0	0	0	0	0	0	0	0	0	0	0	0	0	0	0	0	0	0	0	0	0	0
	GREEN(001)	0	0	0	0	0	0	0	0	0	0	0	0	0	0	0	1	0	0	0	0	0	0	0	0

	GREEN(254)	0	0	0	0	0	0	0	0	1	1	1	1	1	1	1	0	0	0	0	0	0	0	0	0
	GREEN(255)	0	0	0	0	0	0	0	0	1	1	1	1	1	1	1	1	0	0	0	0	0	0	0	0
BLUE	BLUE(000)	0	0	0	0	0	0	0	0	0	0	0	0	0	0	0	0	0	0	0	0	0	0	0	0
	BLUE(001)	0	0	0	0	0	0	0	0	0	0	0	0	0	0	0	0	0	0	0	0	0	0	0	1

	BLUE(254)	0	0	0	0	0	0	0	0	0	0	0	0	0	0	0	0	1	1	1	1	1	1	1	0
	BLUE(255)	0	0	0	0	0	0	0	0	0	0	0	0	0	0	0	0	1	1	1	1	1	1	1	1

3-6 Power Sequence for LCD

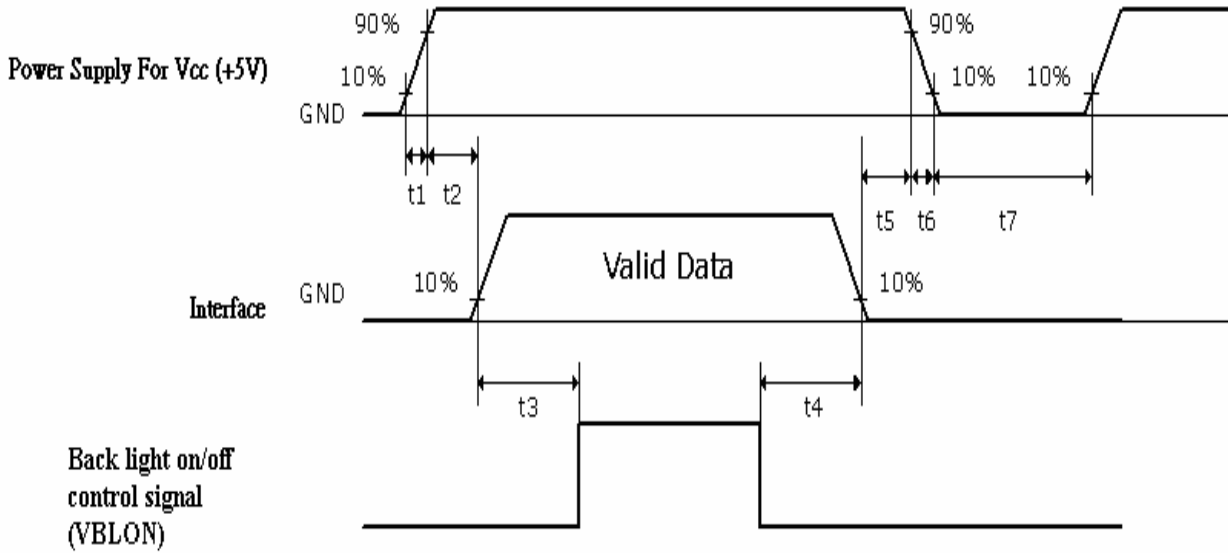

Parameter	Values			Units
	Min.	Typ.	Max.	
t1	0.4	-	20	ms
t2	20	-	50	ms
t3	700or (200)*1	-	-	ms
t4	10	-	-	ms
t5	1	-	50	ms
t6	--	-	300	ms
t7	1	-	-	s

*1: If $t_3=200\text{ms}$, input black signal till 700ms from system is necessary.

In case of $t_3 < 200\text{ms}$, the abnormal display will be happened. But it will not damage timing controller.

Note:

The timing controller will not be damaged in case of TV set AC input power suddenly shut down.

Once power reset, it should follow power sequence as spec. definition.

- (1) Apply the lamp voltage within the LCD operation range. When the back-light turns on before the LCD operation or the LCD turns off before the back-light turns off, the display may momentarily become abnormal screen.

3-7 Power Sequence for Inverter

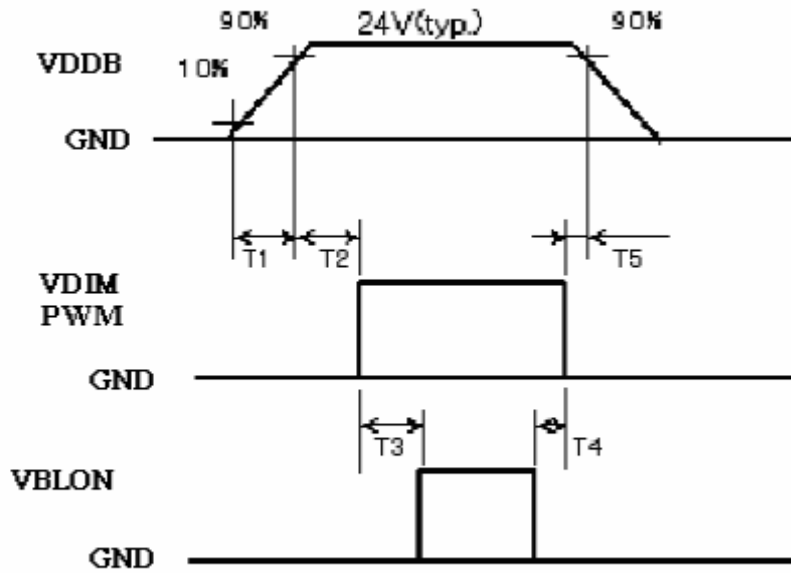

Parameter	Values			Units
	Min.	Typ.	Max.	
T1	20	-	-	ms
T2	50	-	-	ms
T3	50	-	-	ms
T4	50	-	-	ms
T5	0	-	-	ms

www.goodpanel.net

4. Optical Specification

Optical characteristics are determined after the unit has been ‘ON’ and stable for approximately 45 minutes in a dark environment at 25°C. The values specified are at an approximate distance 50cm from the LCD surface at a viewing angle of Φ and θ equal to 0°. Following data are measured at condition $V_{cc}=5.0V$, $F_v=60Hz$, $F_{dclk}=76MHz$, $V_{DDB}=24.0V$, $V_{DIM}=3.3V$, $EDPWM=100\%$.

Fig.1 1 presents additional information concerning the measurement equipment and method.

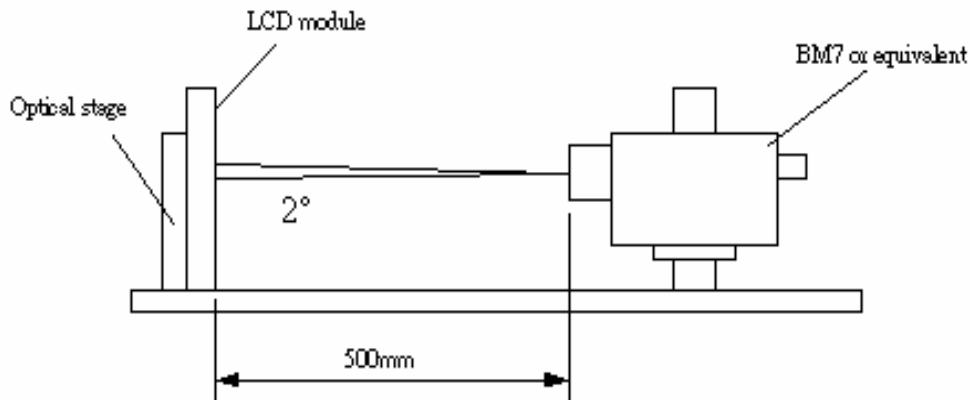

Parameter	Symbol	Values			Units	Notes
		Min.	Typ.	Max.		
Contrast Ratio (center of screen)	CR	800	1000			1
Surface Luminance, white	L255	400	450		cd/m ²	2
Luminance Variation	δ_{WHITE} 9 p			1.3		3
Response Time	Rise Time	T_{rR}	15		ms	4
	Decay Time	T_{rD}	5			
	Gray to Gray	T_{γ}	8			
Color Coordinates	RED	R_X	0.640	Typ.+0.03		
		R_Y	0.330			
	GREEN	G_X	0.290			
		G_Y	0.600			
	BLUE	B_X	0.150			
		B_Y	0.060			
	WHITE	W_X	0.280			
		W_Y	0.290			
Viewing Angle	x axis, right($\phi=0^\circ$)	θ_r	88		Degree	6
	x axis, left($\phi=180^\circ$)	θ_l	88		Degree	
	y axis, up($\phi=90^\circ$)	θ_u	88		Degree	
	y axis, down ($\phi=0^\circ$)	θ_d	88		Degree	

Note:

1. Contrast Ratio (CR) is defined mathematically as:

$$\text{Contrast Ratio} = \frac{L_{255 \text{ of P5}}}{L_0 \text{ of P5}}$$

2. Surface luminance is luminance value at point 5 across the LCD surface 50cm from the surface with all pixels displaying white. From more information see FIG 2.

3. The variation in surface luminance, δ_{WHITE} is defined (center of Screen) as:

$$\delta_{\text{WHITE(9P)}} = \frac{\text{Maximum}(L_{\text{on1}}, L_{\text{on2}}, \dots, L_{\text{on9}})}{\text{Minimum}(L_{\text{on1}}, L_{\text{on2}}, \dots, L_{\text{on9}})}$$

4. Response time is the time required for the display to transition from black to white (Rise Time, Tr_R) and from white to black (Decay Time, Tr_D). For additional information see FIG3.

5. $T\gamma$ is the response time between any two gray scale and is based on $f_v=60\text{Hz}$ to optimize.

6. Viewing angle is the angle at which the contrast ratio is greater than 10. The angles are determined for the horizontal or x axis and the vertical or y axis with respect to the z axis which is normal to the LCD surface. For more information see FIG4.

FIG. 2 Surface luminance- Definition of test point

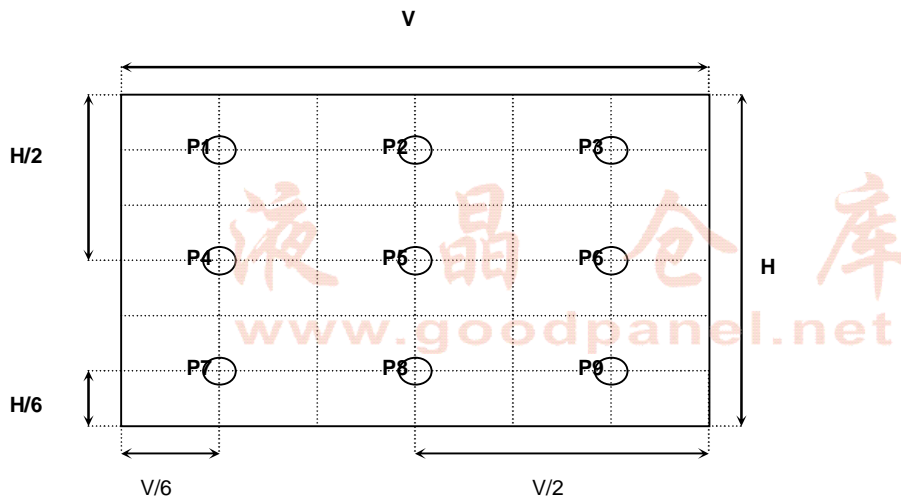

FIG.3 Response Time

The response time is defined as the following figure and shall be measured by switching the input signal for “black” and “white”.

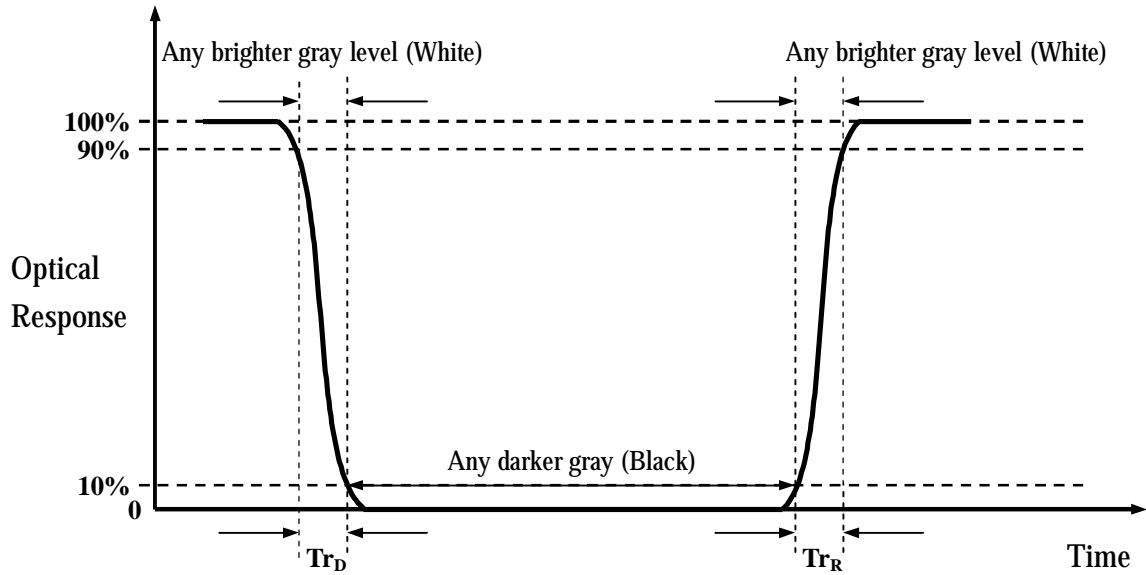
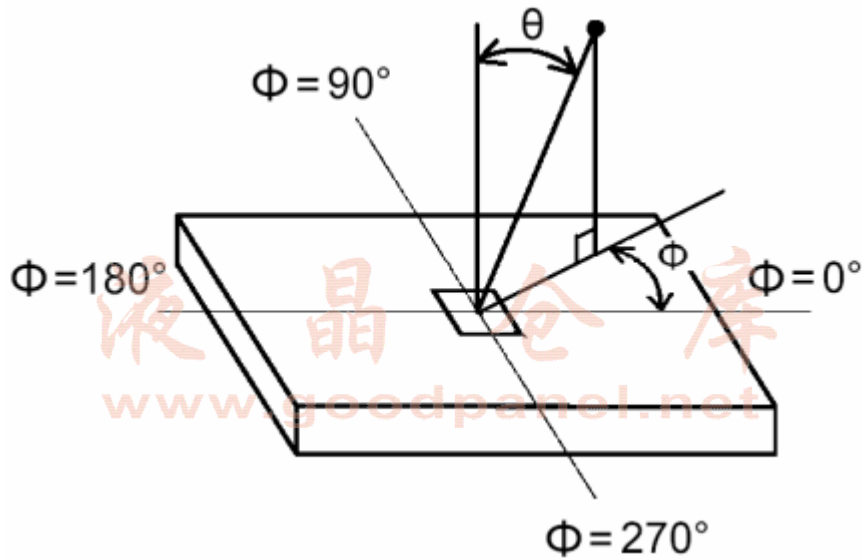

FIG.4 Viewing angle





5. Mechanical Characteristics

The contents provide general mechanical characteristics for the model T260XW02. In addition the figures in the next page are detailed mechanical drawing of the LCD.

Outline Dimension	Horizontal	626.0mm
	Vertical	373.0mm
	Depth	47.5mm(w/i inverter & Shielding) 30.3mm(w/o inverter)
Bezel Area	Horizontal	580.8mm±0.5mm
	Vertical	328.8mm±0.5mm
Active Display Area	Horizontal	575.769mm
	Vertical	323.712mm
Weight	4200g (Typ.)	
Surface Treatment	Anti-Glare, 3H	

液晶仓库
www.goodpanel.net

Front View

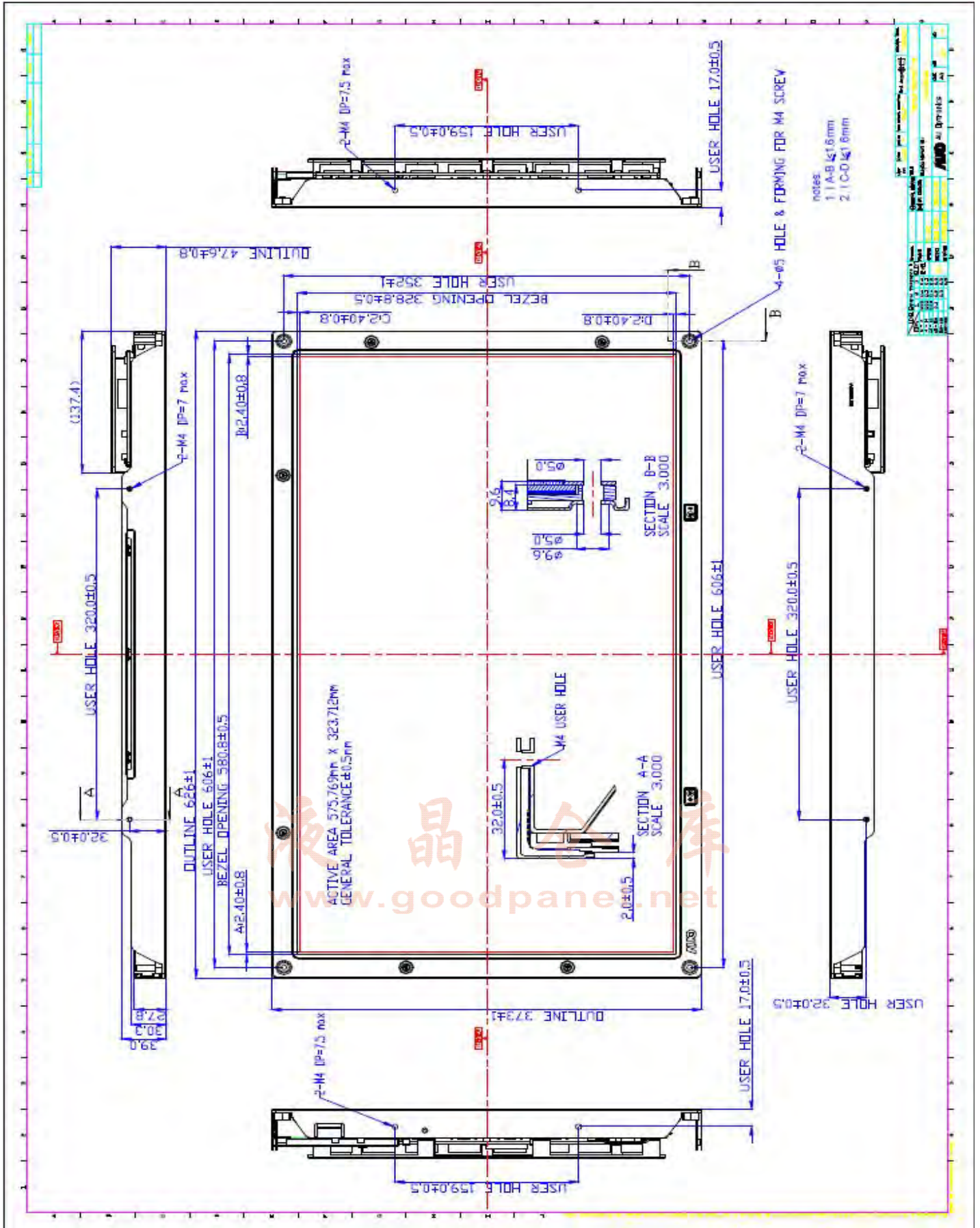

Rear View

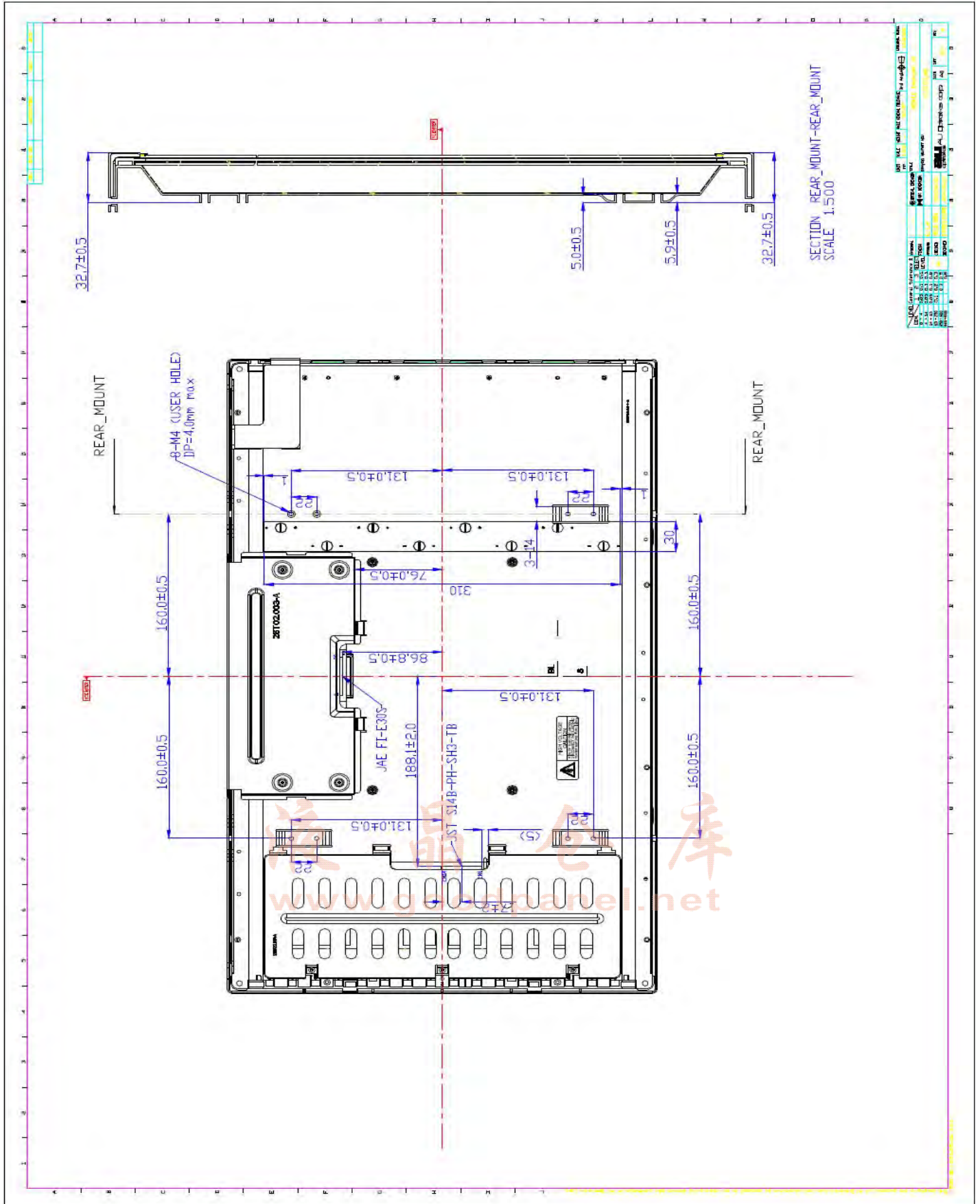

6. Reliability

Environment test condition

No	Test Item	Condition	Remark
1	High temperature storage test	Ta=60°C Determination:500H, End:1000H	Note 1
2	Low temperature storage test	Ta=-20°C Determination:500H, End:1000H	Note 1
3	High temperature operation test	Ta=50°C 80%RH Determination:500H, End:1000H	Note 1
4	Low temperature operation test	Ta=0°C Determination:500H, End:1000H	Note 1
5	Thermal Shock Test	-20°C ~60°C Determination: 100cycle, End:200cycle	Note 2
6	Heat Shock (Soldering Heat Cycle Test)	-40°C ~80°C Determination: 200cycle, End:500cycle	
7	Power On/Off Test	Ta=25°C 40000cycle	
8	Vibration test (non-operating)	Wave form: random Vibration level : 1.0G RMS Bandwidth : 10-500Hz Duration: X, Y, Z 20min One time each direction	
9	Shock test (non-operating)	Shock level: 100G Waveform: half sine wave, 2ms Direction: ±X, ±Y, ±Z One time each direction	
10	Vibration test (with carton)	Random Vibration:10~200Hz,1.5G,30minutes in each X,Y,Z direction	
11	Drop test (with carton)	Height: 53.3cm 1 corner, 3 edges, 6 surfaces (ASTMD4169-I)	
12	ESD	100/250pF air, 10,15,20KV (OP)	
13	Image Sticking	T2hrs, L128 layer	Note 3

{ Result Evaluation Criteria }

There should be no change which might affect the practical display function when the display quality test is conducted under normal operating condition.

Note

1. 1000H is for reference
2. 200cycles is for reference
3. Image Sticking Test Mode
 - (a) Driving Method: Normal operation
 - (b) Display Pattern:

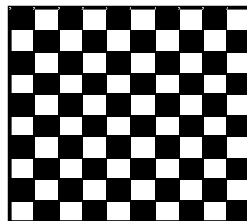



P1: 10X10 Black & White Check Pattern

P2: Gray Luster (Gray level 128.)

(c) Test Procedure

A. Turn to testing pattern (10X10 Black & White Check Pattern) and keep lighting-on 2hrs.

B. Change to gray pattern. Then visually observe if an objectionable persisting shadow exists or not.

(d) Judge Criteria: No distinguished Mura compared with original pattern

液晶仓库
www.goodpanel.net

7. International Standard

7-1. Safety

(1) UL1950 Third Edition, Underwriters Laboratories, Inc. Jan. 28, 1995

Standard for Safety of Information Technology Equipment Including electrical Business Equipment.

(2) CAN/CSA C22.2 No. 950-95 Third Edition, Canadian Standards Association, Jan. 28, 1995

Standard for Safety of Information Technology Equipment Including Electrical Business Equipment.

(3) EN60950: 1992+A2: 1993+A2: 1993+C3: 1995+A4: 1997+A11: 1997

IEC 950: 1991+A1: 1992+A2: 1993+C3: 1995+A4:1996

European Committee for Electrotechnical Standardization (CENELEC)

EUROPEAN STANDARD for Safety of Information Technology Equipment Including Electrical Business Equipment.

7-2. EMC

a) ANSI C63.4 “Methods of Measurement of Radio-Noise Emissions from Low-Voltage Electrical and Electrical Equipment in the Range of 9kHz to 40GHz. “American National standards Institute(ANSI), 1992.

b) C.I.S.P.R “Limits and Methods of Measurement of Radio Interface Characteristics of Information Technology Equipment.” International Special committee on Radio Interference.

c) EN 55022 “Limits and Methods of Measurement of Radio Interface Characteristics of Information Technology Equipment.” European Committee for Electrotechnical Standardization. (CENELEC), 1998.

7-3. Green

Green Mark Description:

a) For Pb Free products, AUO will add  for identification.

b) For RoHS compatible products, AUO will add  for identification.

Note. The Green Mark will be present only when the green documents have been ready by AUO Internal Green Team. (The definition of green design follows the AUO green design checklist.)



Packing

Label sample

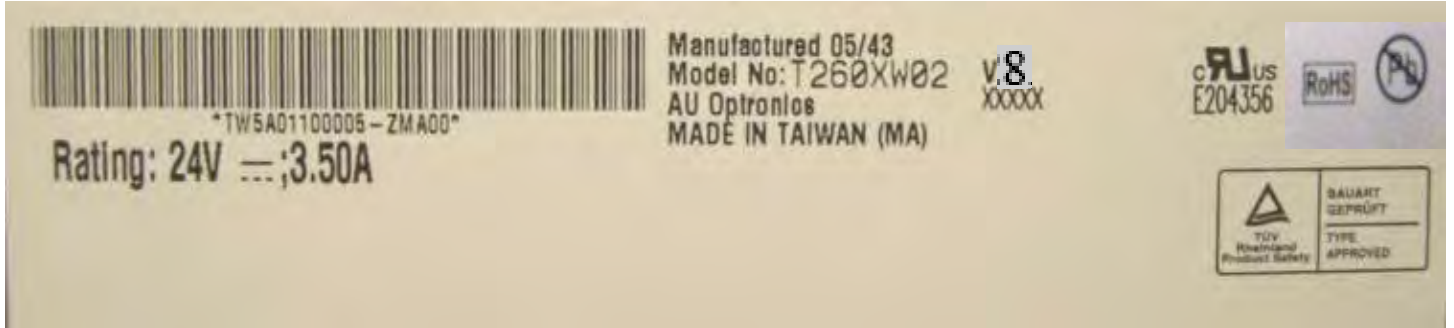

TW5A01100005-ZMA00*

TW5A011: Production lot, T: Taiwan made, M: China made

00005: Panel serial number

ZMA: AUO internal code

Manufactured 05/43: 2005 week 43

Made in Taiwan: Taiwan made

Carton Label





Carton Size 768(L)mm*330(W)mm*480(H)mm

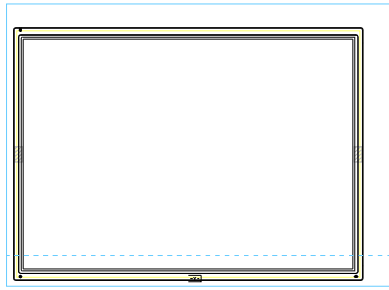

1pcs Module/ESD Bag

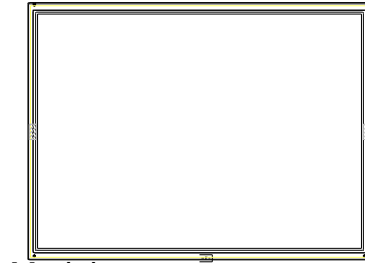

Module

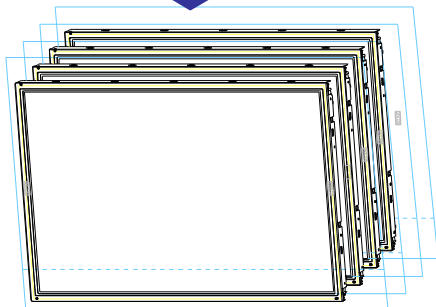

4pcs Modules

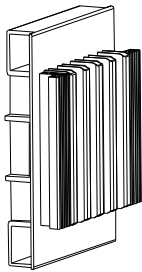

Cushion set

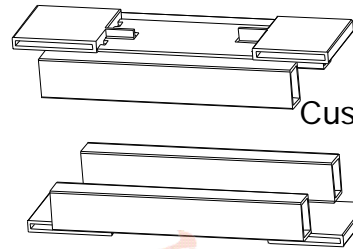
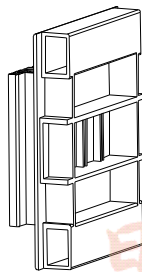

Cushion top

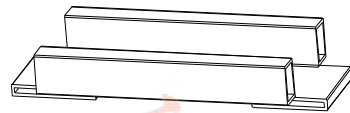

Cushion down



4pcs / 1 carton



"H" Tape

Shipment Data

	Item	Specification			Packing Remark
		Qty.	Dimension	Weight (kg)	
1	Packing BOX	4pcs/box	768(L)mm*324(W)mm*480(H)mm	20	
2	Pallet	1	990(L)mm*780(W)mm*120(H)mm		
3	Boxes per Pallet	9 boxes/Pallet			
4	Panels per Pallet	36pcs/pallet			
	Pallet after packing	36	990(L)mm*780(W)mm*1560(H)mm	190	

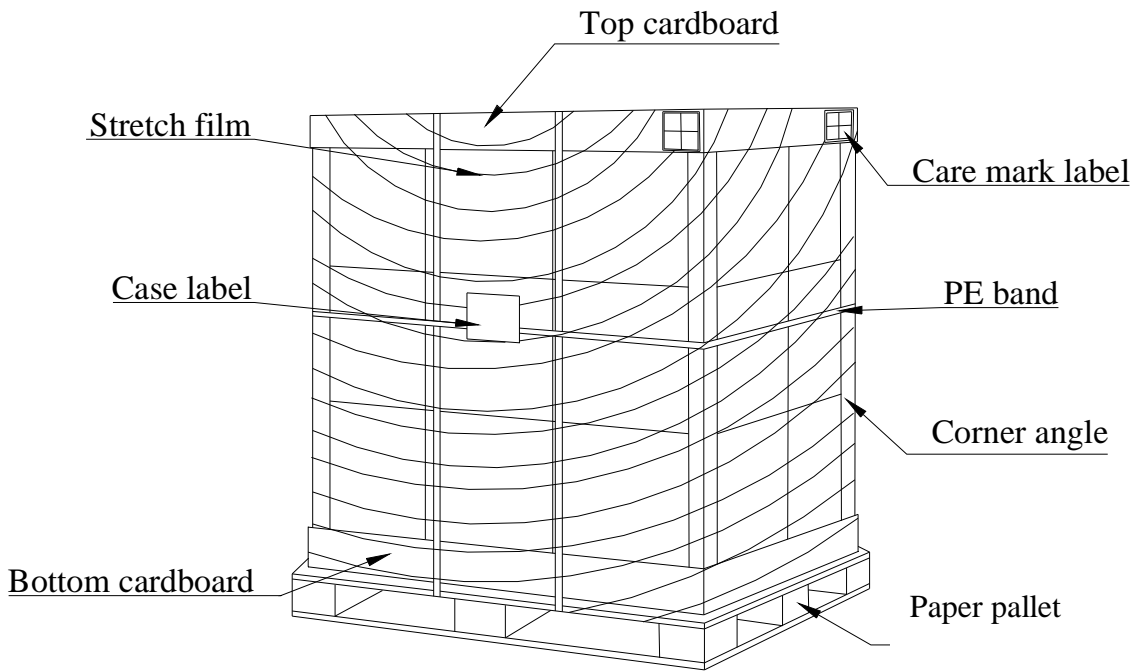

液晶仓库
www.goodpanel.net



PRECAUTIONS

Please pay attention to the followings when you use this TFT LCD module.

9-1 MOUNTING PRECAUTIONS

- (1) You must mount a module using holes arranged in four corners or four sides.
- (2) You should consider the mounting structure so that uneven force (ex. Twisted stress) is not applied to module. And the case on which a module is mounted should have sufficient strength so that external force is not transmitted directly to the module.
- (3) Please attach the surface transparent protective plate to the surface in order to protect the polarizer. Transparent protective plate should have sufficient strength in order to resist external force.
- (4) You should adopt radiation structure to satisfy the temperature specification.
- (5) Acetic acid type and chlorine type materials for the cover case are not desirable because the former generates corrosive gas of attacking the polarizer at high temperature and the latter causes circuit break by electro-chemical reaction.
- (6) Do not touch, push or rub the exposed polarizers with glass, tweezers or anything harder than HB pencil lead. And please do not rub with dust clothes with chemical treatment. Do not touch the surface of polarizer for bare hand or greasy cloth. (Some cosmetics are detrimental to the polarizer.)
- (7) When the surface becomes dusty, please wipe gently with absorbent cotton or other soft materials like chamois soaks with petroleum benzene. Normal-hexane is recommended for cleaning the adhesives used to attach front/ rear polarizers. Do not use acetone, toluene and alcohol because they cause chemical damage to the polarizer.
- (8) Wipe off saliva or water drops as soon as possible. Their long time contact with polarizer causes deformations and color fading.
- (9) Do not open the case because inside circuits do not have sufficient strength.

9-2 OPERATING PRECAUTIONS

- (1) The spike noise causes the mis-operation of circuits. It should be lower than following voltage:
 $V = \pm 200\text{mV}$ (Over and under shoot voltage)
- (2) Response time depends on the temperature. (In lower temperature, it becomes longer..)
- (3) Brightness depends on the temperature. (In lower temperature, it becomes lower.) And in lower temperature, response time (required time that brightness is stable after turned on) becomes longer.
- (4) Be careful for condensation at sudden temperature change. Condensation makes damage to polarizer or electrical contacted parts. And after fading condensation, smear or spot will occur.
- (5) When fixed patterns are displayed for a long time, remnant image is likely to occur.
- (6) Module has high frequency circuits. Sufficient suppression to the electromagnetic interference shall be done by system manufacturers. Grounding and shielding methods may be important to minimize the interface.



9-3 ELECTROSTATIC DISCHARGE CONTROL

Since a module is composed of electronic circuits, it is not strong to electrostatic discharge. Make certain that treatment persons are connected to ground through wrist band etc. And don't touch interface pin directly.

9-4 PRECAUTIONS FOR STRONG LIGHT EXPOSURE

Strong light exposure causes degradation of polarizer and color filter.

9-5 STORAGE

When storing modules as spares for a long time, the following precautions are necessary.

- (1) Store them in a dark place. Do not expose the module to sunlight or fluorescent light. Keep the temperature between 5°C and 35°C at normal humidity.
- (2) The polarizer surface should not come in contact with any other object. It is recommended that they be stored in the container in which they were shipped.

9-6 HANDLING PRECAUTIONS FOR PROTECTION FILM

- (1) The protection film is attached to the bezel with a small masking tape. When the protection film is peeled off, static electricity is generated between the film and polarizer. This should be peeled off slowly and carefully by people who are electrically grounded and with well ion-blown equipment or in such a condition, etc.
- (2) When the module with protection film attached is stored for a long time, sometimes there remains a very small amount of glue still on the Bezel after the protection film is peeled off.
- (3) You can remove the glue easily. When the glue remains on the Bezel or its vestige is recognized, please wipe them off with absorbent cotton waste or other soft material like chamois soaked with normal-hexane.

液晶仓库
www.goodpanel.net