



Product Description: T315XW02 TFT-LCD PANEL			
-----			
AUO Model Name: T315XW02 V6			
Customer Part No/Project Name:			
Customer Signature	Date	AUO	Date



**Document Version : 0.7**

**Date : 2006/7/13**

## **Product Specifications**

**31.5" WXGA Color TFT-LCD Module**

**Model Name: T315XW02 V6**

**( ) Preliminary Specifications**

**(\* ) Final Specifications**



## Contents

No	
	COVER
	CONTENTS
	RECORD OF REVISIONS
1	GENERAL DESCRIPTION
2	ABSOLUTE MAXIMUM RATINGS
3	ELECTRICAL SPECIFICATIONS
3-1	ELECTRICAL CHARACTERISTICS
3-2	INTERFACE CONNECTIONS
3-3	SIGNAL TIMING SPECIFICATIONS
3-4	SIGNAL TIMING WAVEFORMS
3-5	COLOR INPUT DATA REFERENCE
3-6	POWER SEQUENCE
4	OPTICAL SPECIFICATIONS
5	MECHANICAL CHARACTERISTICS
6	RELIABILITY
7	INTERNATIONAL STANDARDS
7-1	SAFETY
7-2	EMC
8	PACKING
9	PRECAUTIONS



## Record of Revision

Version	Date	No	Old Description	New Description	Remark
0	2006/3/16		First issue		
0.1	2006/3/31	3-1	Electrical Characteristics- Power Supply Input Current: 1.2A (Typ.)	Electrical Characteristics- Power Supply Input Current: 1A (Typ.), 1.2A(Max)	Value update
		3-1	Electrical Characteristics- Power Consumption: 14.4 Watt (Typ.)	Electrical Characteristics- Power Consumption: 12Watt (Typ.) 13.2 Watt (Max)	Value update
		3-1	Inrush Current: TBD (Typ.)	Inrush Current: TBD (Typ., Max))	Value update
		3-2	Electrical specification- VBLON, On=3V (Min)	Electrical specification- VBLON, On=2V (Min)	Value update
		3-2	Electrical specification- V_PWM(Max)=3V (Min)	Electrical specification- V_PWM(Max)=2V (Min)	Value update
		3-2	Electrical specification- External PWM Frequency, F_EPWM: 120(Min), 240(Max)	Electrical specification- External PWM Frequency, F_EPWM: 150(Min), 300(Max)	Value update
		3-3	Signal Timing Specifications	Signal Timing Specification with new measured value	Value update
		3.6.1	Power Sequence for LCD: Parameters table, t2=100(Max.),	Power Sequence for LCD: Parameters table, t2=50(Max.),	Value update
		3.6.2	Power Sequence for Inverter	Power Sequence for Inverter with new figure and parameters	Figure and value update
		5	Mechanical Characteristics Figure	New Mechanical Characteristics Figure	Pin assignment update
0.2	2006/4/13	3-2	LCD connector (CN3): JAE or equivalent	LCD connector (CN3): JAE and Mating connector: UJU JEIDA mode figure insert	Connector update
		3-2		Electrical specification: Input current (Turn on condition) Input Power (Turn on condition)	Value update
		3.6.1	Power Sequence for Inverter Parameters table, t3=800(Min.), t4=200(Min.)	Power Sequence for Inverter Parameters table, t3=350(Min.), t4=10(Min.)	Value update
0.3	2006/5/8	2	LCD Driver Voltage: 7V (Max)	LCD Driver Voltage: 12V (Max)	Value update



		3	Power Supply Input Current	Power Supply Input Current, 1(A) Typ., 1.2(A) Max.	Value update
		3	Power Consumption	Power Consumption 12W(Typ.), 13.2(Typ.)	Value update
		3-2	Inverter connection	Inverter connection, compatible JAE guarantee	
		3-6	Power sequence	Power Sequence update	Value update
		4	Optical specification: response time (Gray to Gray)	Optical specification:response time (MPRT)	Value update
0.4	2006/6/14	3-6-1	Timing setting: t6=30ms	Timing setting: t6=300ms	Value update
		3-6-2	Timing setting: t3 and t4=50ms	Timing setting: t3 and t4=0ms	Value update
		4	Optical specification: CR and Surface luminance, no min. value	Optical specification: CR and Surface luminance, define min. value	Value update
		4	MPRT	MPRT definition and measure condition	
		8	Panel label	Definition of Panel label	
0.5	2006/6/21	3-1	Inrush current: TBD	Inrush current: 4(Typ.), 6(Max.)	Value update
		4	Response Time: MPRT	Response time: Gray to Gray	
0.6	2006/7/1	5	Mechanical Characteristic	Outline dimension 760+/-0.5 to 760+/-1mm 450+/-0.5 to 450+/-1mm	Value update
		4	Viewing Angle: 88	Viewing Angle: 89	Value update
0.7	2006/7/10	3-2	LCD connector: JAE FI-RE51S-HF, mating connector: UJU IS050-C51B-C39	LCD connector: JAE FI-RE51S-HF only	Update
		3-2	Note 2:JEIDA mode not available	Note 2: JEIDA mode available	Update



## 1. General Description

This specification applies to the 31.51 inch Color TFT-LCD Module T315XW02 V6. This LCD module has a TFT active matrix type liquid crystal panel 1366x768 pixels, and diagonal size of 31.51 inch. This module supports 1366x768 XGA-WIDE mode (Non-interlace). Each pixel is divided into Red, Green and Blue sub-pixels or dots which are arranged in vertical stripes. Gray scale or the brightness of the sub-pixel color is determined with a 8-bit gray scale signal for each dot.

The T315XW02 V6 has been designed to apply the 8-bit 2 channel LVDS interface method. It is intended to support displays where high brightness, wide viewing angle, high color saturation, and high color depth are very important.

### \* General Information

Items	Specification	Unit	Note
Active Screen Size	31.51 inches		
Display Area	697.685 (H) x 392.256(V)	mm	
Outline Dimension	760.0(H) x 450.0(V) x 45(D)	mm	With inverter
Driver Element	a-Si TFT active matrix		
Display Colors	16.7M	Colors	
Number of Pixels	1366 x 768	Pixel	
Pixel Pitch	0.51075	mm	
Pixel Arrangement	RGB vertical stripe		
Display Mode	Normally Black		
Surface Treatment	AG, 3H		



## 2. Absolute Maximum Ratings

The following are maximum values which, if exceeded, may cause permanent damage to the unit.

Item	Symbol	Min	Max	Unit	Conditions
Logic/LCD Drive Voltage	Vcc	-0.3	14.0	[Volt]	Note 1
Input Voltage of Signal	Vin	-0.3	3.6	[Volt]	Note 1
BLU Input Voltage	VDDB	-0.3	27	[Volt]	Note 1
BLU Brightness Control Voltage	VBLON	-0.3	7.0	[Volt]	Note 1
Operating Temperature	TOP	0	+50	[°C]	Note 2
Operating Humidity	HOP	10	90	[%RH]	Note 2
Storage Temperature	TST	-20	+60	[°C]	Note 2
Storage Humidity	HST	10	90	[%RH]	Note 2

Note 1: Duration: 50 msec.

Note 2 : Maximum wet-bulb should be 39°C and No condensation.

The relative humidity must not exceed 90% non-condensing at temperatures of 40°C or less. At temperatures greater than 40°C, the wet bulb temperature must not exceed 39°C.

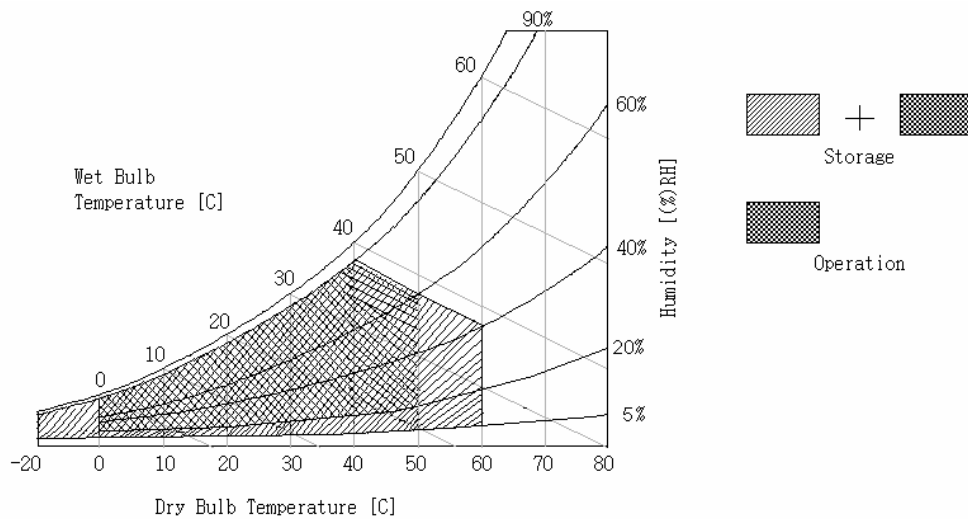



### 3. Electrical Specification

The T315XW02 V6 requires two power inputs. One is employed to power the LCD electronics and to drive the TFT array and liquid crystal. The second input power for the BLU, is to power inverter..

#### 3-1 Electrical Characteristics

Parameter	Symbol	Values			Unit	Notes	
		Min	Typ	Max			
LCD:							
Power Supply Input Voltage	Vcc	10.8	12.0	13.2	Vdc	1	
Power Supply Input Current	Icc		1	1.2	A	2	
Power Consumption	Pc	-	12	13.2	Watt	2	
Inrush Current	I <sub>CCRUSH</sub>	-	4	6	A <sub>peak</sub>	3	
LVDS Interface	Differential Input High Threshold Voltage	VTH			+100	mV	4
	Differential Input Low Threshold Voltage	VTL	-100			mV	4
	Common Input Voltage	VICM	1.10	1.25	1.40	V	4
CMOS Interface	Input High Threshold Voltage	VIH (High)	2.4		3.3	Vdc	
	Input Low Threshold Voltage	VIL (Low)	0		0.7	Vdc	
Backlight Power Consumption	PDDDB		108	118	Watt	5,6	
Life Time		60,000			Hours	7	



**Note :**

1. The ripple voltage should be controlled under 5% of  $V_{CC}$
2.  $V_{CC}=12.0V$ ,  $f_v = 120Hz$ ,  $f_{CLK}=(TBD)$  MHz ,  $25^{\circ}C$ , Test Pattern : White Pattern
3. Measurement condition:

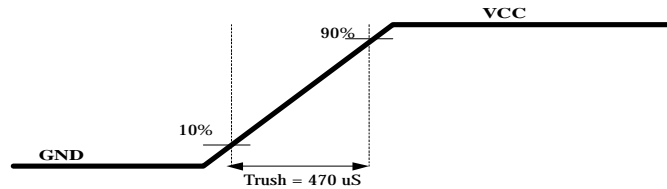

4.  $V_{CIM} = 1.2V$

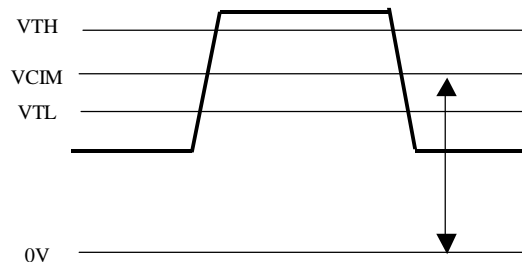

5. The performance of the Lamp in LCM, for example life time or brightness, is extremely influenced by the characteristics of the DC-AC Inverter. So all the parameters of an inverter should be carefully designed so as not to produce too much leakage current from high-voltage output of the inverter. When you design or order the inverter, please make sure unwanted lighting caused by the mismatch of the lamp and the inverter (no lighting, flicker, etc) never occurs. When you confirm it, the LCD assembly should be operated in the same condition as installed in your instrument.
6. Do not attach a conducting tape to lamp connecting wire. If the lamp wire attach to conducting tape, TFT-LCD Module have a low luminance and the inverter has abnormal action because leakage current occurs between lamp wire and conducting tape.
7. The relative humidity must not exceed 80% non-condensing at temperatures of  $40^{\circ}C$  or less. At temperatures greater than  $40^{\circ}C$ , the wet bulb temperature must not exceed  $39^{\circ}C$ . When operate at low temperatures, the brightness of CCFL will drop and the life time of CCFL will be reduced.



### 3-2 Interface Connections

- LCD connector : JAE FI-RE51S-HF
- LVDS Transmitter: DS90C385 (NS) or equivalent

Pin	Symbol	Description	Pin	Symbol	Description
1	Power	DC 12V	26	RE[0]P	Even LVDS Signal +
2	Power	DC 12V	27	RE[1]N	Even LVDS Signal -
3	Power	DC 12V	28	RE[1]P	Even LVDS Signal +
4	Power	DC 12V	29	RE[2]N	Even LVDS Signal -
5	Power	DC 12V	30	RE[2]P	Even LVDS Signal +
6	GND	GND	31	GND	GND
7	GND	GND	32	RECLK-	Even LVDS Clock -
8	GND	GND	33	RECLK+	Even LVDS Clock +
9	GND	GND	34	GND	GND
10	RO[0]N	Odd LVDS Signal -	35	RE[3]N	Even LVDS Signal -
11	RO[0]P	Odd LVDS Signal +	36	RE[3]P	Even LVDS Signal +
12	RO[1]N	Odd LVDS Signal -	37	NC	NC
13	RO[1]P	Odd LVDS Signal +	38	NC	NC
14	RO[2]N	Odd LVDS Signal -	39	GND	GND
15	RO[2]P	Odd LVDS Signal +	40	NC	NC
16	GND	GND	41	NC	NC
17	ROCLK-	Odd LVDS Clock -	42	NC	NC
18	ROCLK+	Odd LVDS Clock +	43	NC	NC
19	GND	GND	44	NC	NC
20	RO[3]N	Odd LVDS Signal -	45	LVDS_SEL	LVDS JEIDA/NS Option
21	RO[3]P	Odd LVDS Signal +	46	NC	NC
22	NC	NC	47	NC	NC
23	NC	NC	48	NC	NC
24	GND	GND	49	NC	NC
25	RE[0]N	Even LVDS Signal -	50	NC	NC
			51	NC	NC

**Note:**

1. All GND (ground) pins should be connected together and should also be connected to the LCD's metal frame. All Vcc (power input) pins should be connected together.
2. High: NS mode  
Low/Open: JEIDA mode
3. Do not connect NC pins. Connecting these pins to Ground or any voltage is not allowable.



### LVDS Option = H (3.3V), NS mode

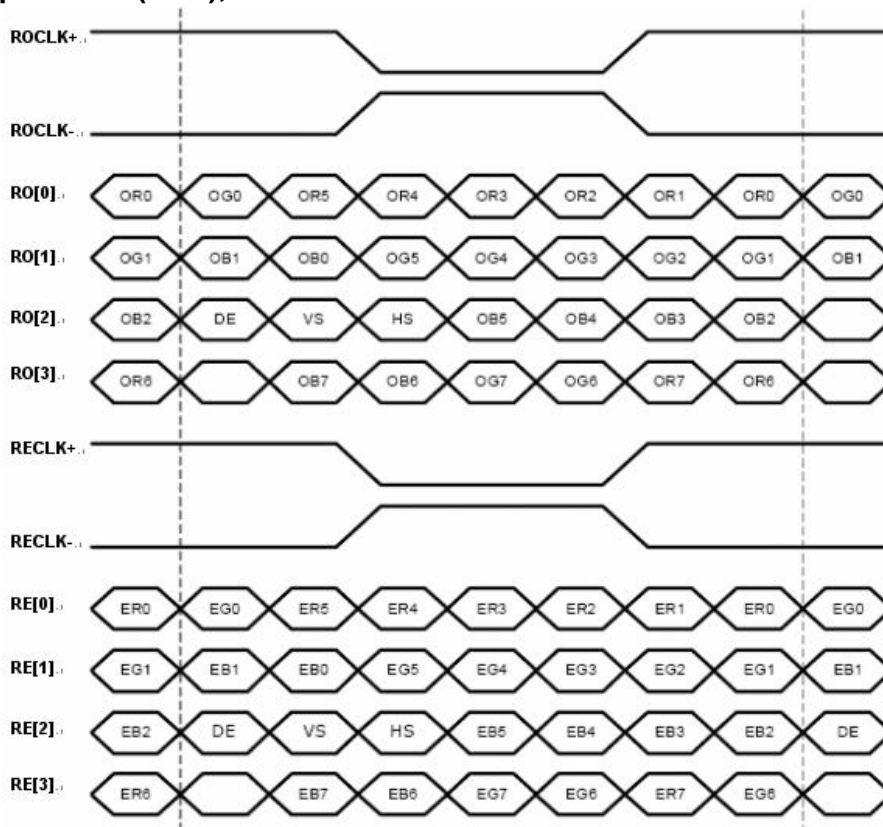

Note:

- ⌋ Odd data is the first priority.
- ⌋ First data is odd.

### LVDS Option = Low/Open, JEIDA mode

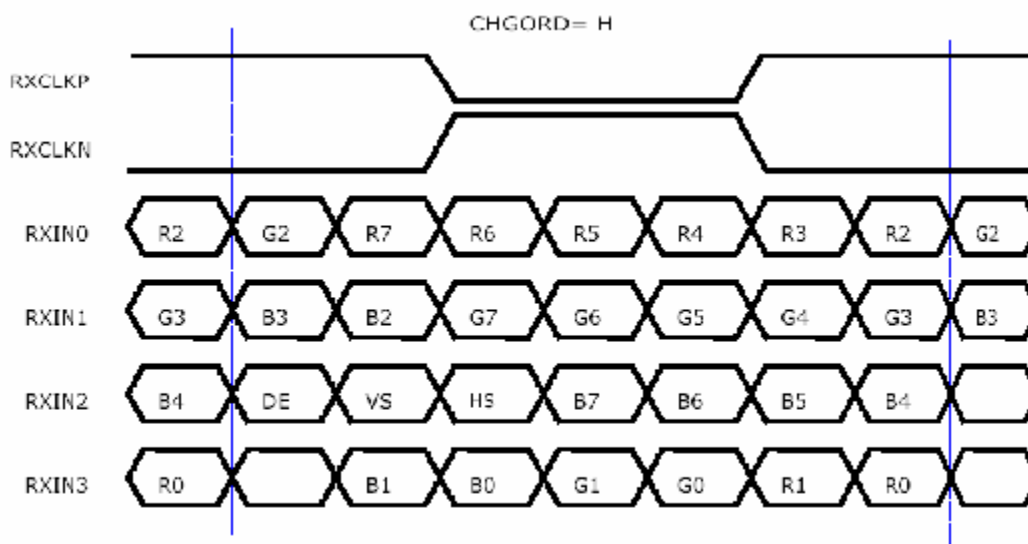

Note: R/G/B7s are MSBs and R/G/B0s are LSBs



## BACKLIGHT CONNECTOR PIN CONFIGURATION -

### 1. Electrical specification

Item	Symb.	Condition	Spec			Unit	Note
			Min	Typ	Max		
Input Voltage	VDDB	---	21.6	24.0	26.4	VDC	
Input Current (Turn On Condition)	IDDB	VDDB=24V	4.25	4.77	5.29	ADC	1
Input Power (Turn On Condition)	PDDB	VDDB=24V		115	125		1
Input Current (Stable Condition)	IDDB	VDDB=24V	3.99	4.49	4.98		1
Input Power (Stable Condition)	PDDB	VDDB=24V	---	108	118	W	1
Inrush Current	IRUSH	VDDB=24V	---	---	(6.0)	ADC	1,2
On/Off Control Voltage	VBLON	ON	VDDB=24V	2.0	---	5.0	VDC
		OFF	VDDB=24V	0.0	---	0.8	
On/Off Control Current	IBLON	VDDB=24V	0.0	---	1.5	mADC	
Dimming Control Voltage	VDIM	MAX	VDDB=24V	---	0	---	VDC
		MIN	VDDB=24V	---	3.3	---	
PWM Function	V_PWM	MAX	---	2.0	---	5.0	VDC
		MIN	---	0.0	---	0.8	
External PWM Control Current	I_EPWM	---	---	---	1.5	mADC	
External PWM Duty Ratio	D_EPWM	---	50	---	100	%	
External PWM Frequency	F_EPWM	---	150	180	300	Hz	

Note1 : VDIM= 0V ( Ta=25±5°C, Turn on for 45minutes )

Note 2 : Measurement condition à Rising time = 20 ms (VDDB : 10%~90%);

### 2. Input specification

CN1: JST PHR-14 or equivalent

No	Symbol	Description
1-5	VDDB (Main Power)	DC input 24.0 VDC
6-10	GND	Ground
11	VDIM (LCD Bright)	Dimming control signal input (0~3.3V) (GND : Maximum brightness)
12	VBLON (Enable Pin)	On/Off control Signal; High: On; Low: Off
13	EPWM	External PWM input for dimming control (If do not use, please leave it open. Connect to GND will enter protection mode)
14	PWM-Function	High : internal PWM(Pin 11), Low/Open : external PWM (Pin 13)



### 3-3 Signal Timing Specifications

This is the signal timing required at the input of the User connector. All of the interface signal timing should be satisfied with the following specifications for it's proper operation.

DE mode only

Vertical Frequency Range A

Signal	Item	Symbol	Min	Typ	Max	Unit
Horizontal	Period	Th	748	780	800	CLK
	Active	Tdisp(h)	683			CLK
	Blanking	Tblk(h)	65	97	117	CLK
Vertical	Period	Tv	930	960	980	Line
	Active	Tdisp(v)	768			Line
	Blanking	Tblk(v)	162	192	212	Line
CLK	Frequency	fCLK	69.7	74.9	82.0	MHz
Line	Frequency	-	92.1	96.0	100.0	KHz
Frame	Frequency	-	98	100	102	Hz

Vertical Frequency Range B

Signal	Item	Symbol	Min	Typ	Max	Unit
H (CLK)	Period	Th	748	780	800	CLK
	Active	Tdisp(h)	683			CLK
	Blanking	Tblk(h)	65	97	117	CLK
V (Line)	Period	Tv	776	780	800	Line
	Active	Tdisp(v)	768			Line
	Blanking	Tblk(v)	8	12	32	Line
CLK	Frequency	fCLK	69.7	73.0	78.1	MHz
Line	Frequency	-	91.6	93.6	97.6	KHz
Frame	Frequency	-	118	120	122	Hz

Note:

u It is not proposed to operate H(CLK) Min. and V(Line) Min. at the same time. It should be limited by fCLK Min.

1.) Display position is specific by the rise of DE signal only.

Horizontal display position is specified by the rising edge of 1<sup>st</sup> CLK after the rise of 1<sup>st</sup> DE, is displayed on the left edge of the screen.

Vertical display position is specified by the rise of DE after a "Low" level period equivalent to eight times of horizontal period. The 1<sup>st</sup> data corresponding to one horizontal line after the rise the of 1<sup>st</sup> DE is displayed at the top line of screen.

3.) If a period of DE "High" is less than 1366 CLK or less than 768 lines, the rest of the screen displays black.

4.) The display position does not fit to the screen if a period of DE "High" and the effective data period do not synchronize with each other.

©Copyright AU Optronics, Inc.

January, 2003 All Rights Reserved. T315XW02 V6 - Specs. Ver 0.7

13/29

No Reproduction and Redistribution Allowed



### 3-4 Signal Timing Waveform

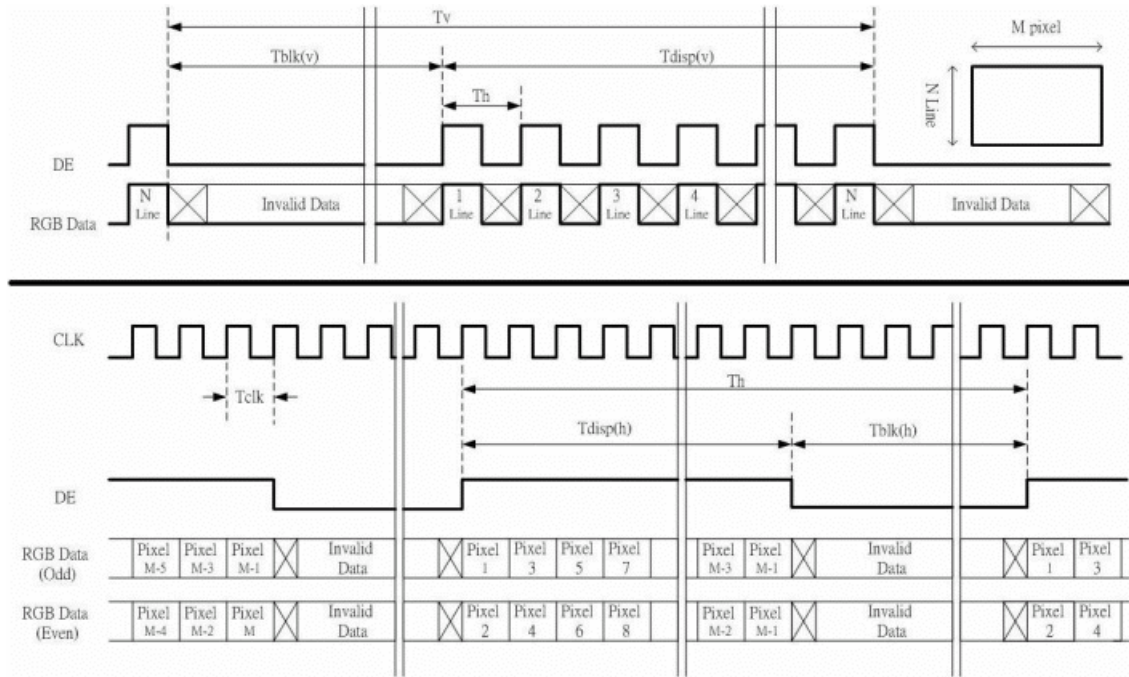



### 3-5 Color Input Data Reference

The brightness of each primary color (red, green and blue) is based on the 8 bit gray scale data input for the color; the higher the binary input, the brighter the color. The table below provides a reference for color versus data input.

#### COLOR DATA REFERENCE

Color		Input Color Data																							
		RED								GREEN								BLUE							
		MSB				LSB				MSB				LSB				MSB				LSB			
		R7	R6	R5	R4	R3	R2	R1	R0	G7	G6	G5	G4	G3	G2	G1	G0	B7	B6	B5	B4	B3	B2	B1	B0
Basic Color	Black(L0)	0	0	0	0	0	0	0	0	0	0	0	0	0	0	0	0	0	0	0	0	0	0	0	0
	Red(L255)	1	1	1	1	1	1	1	1	0	0	0	0	0	0	0	0	0	0	0	0	0	0	0	0
	Green(L255)	0	0	0	0	0	0	0	0	1	1	1	1	1	1	1	1	0	0	0	0	0	0	0	0
	Blue(L255)	0	0	0	0	0	0	0	0	0	0	0	0	0	0	0	0	1	1	1	1	1	1	1	1
	Cyan	0	0	0	0	0	0	0	0	1	1	1	1	1	1	1	1	1	1	1	1	1	1	1	1
	Magenta	1	1	1	1	1	1	1	1	0	0	0	0	0	0	0	0	1	1	1	1	1	1	1	1
	Yellow	1	1	1	1	1	1	1	1	1	1	1	1	1	1	1	1	0	0	0	0	0	0	0	0
	White	1	1	1	1	1	1	1	1	1	1	1	1	1	1	1	1	1	1	1	1	1	1	1	1
RED	RED(L0)	0	0	0	0	0	0	0	0	0	0	0	0	0	0	0	0	0	0	0	0	0	0	0	0
	RED(L1)	0	0	0	0	0	0	0	1	0	0	0	0	0	0	0	0	0	0	0	0	0	0	0	0
	---																								
	RED(L254)	1	1	1	1	1	1	1	0	0	0	0	0	0	0	0	0	0	0	0	0	0	0	0	0
	RED(L255)	1	1	1	1	1	1	1	1	0	0	0	0	0	0	0	0	0	0	0	0	0	0	0	0
GREEN	GREEN(L0)	0	0	0	0	0	0	0	0	0	0	0	0	0	0	0	0	0	0	0	0	0	0	0	0
	GREEN(L1)	0	0	0	0	0	0	0	0	0	0	0	0	0	0	0	1	0	0	0	0	0	0	0	0
	---																								
	GREEN(L254)	0	0	0	0	0	0	0	0	1	1	1	1	1	1	1	0	0	0	0	0	0	0	0	0
	GREEN(L255)	0	0	0	0	0	0	0	0	1	1	1	1	1	1	1	1	0	0	0	0	0	0	0	0
BLUE	BLUE(L0)	0	0	0	0	0	0	0	0	0	0	0	0	0	0	0	0	0	0	0	0	0	0	0	0
	BLUE(L1)	0	0	0	0	0	0	0	0	0	0	0	0	0	0	0	0	0	0	0	0	0	0	0	1
	-----																								
	BLUE(L254)	0	0	0	0	0	0	0	0	0	0	0	0	0	0	0	0	1	1	1	1	1	1	1	0
	BLUE(L255)	0	0	0	0	0	0	0	0	0	0	0	0	0	0	0	0	1	1	1	1	1	1	1	1



## 3-6 Power Sequence for LCD Module

### 3.6.1 Power Sequence for LCD

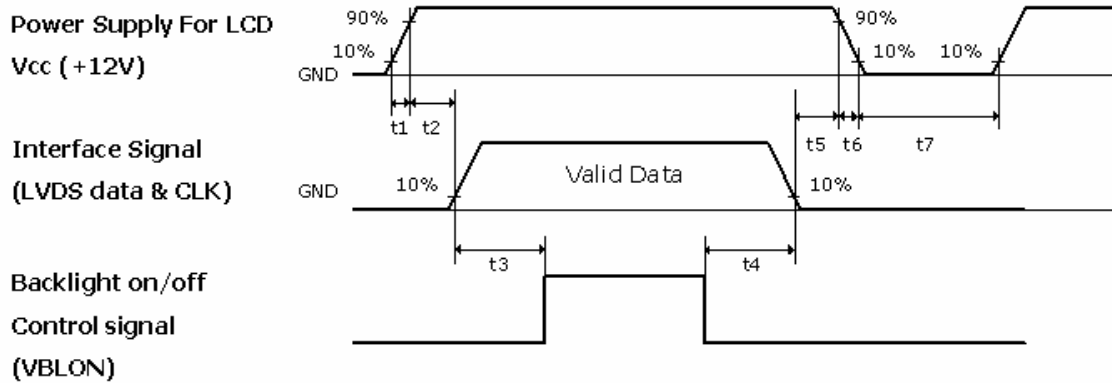

Parameter	Values			Units
	Min.	Typ.	Max.	
t1	470	-	5000	us
t2	20	-	50	ms
t3	350	-	-	ms
t4	10	-	-	ms
t5	1	-	50	ms
t6		-	300	ms
t7	1	-	-	s

- (1) Apply the lamp voltage within the LCD operation range. When the back-light turns on before the LCD operation or the LCD turns off before the back-light turns off, the display may momentarily become abnormal screen.





### 3.6.2 Power Sequence for Inverter

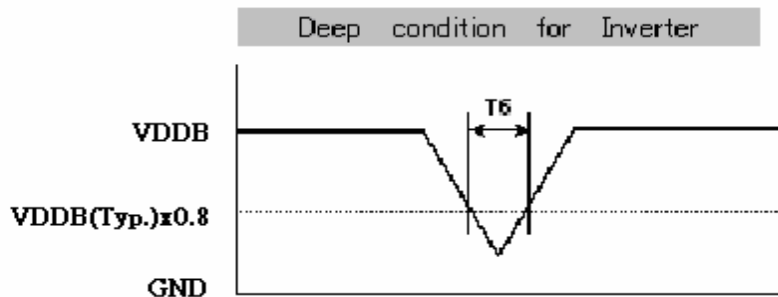
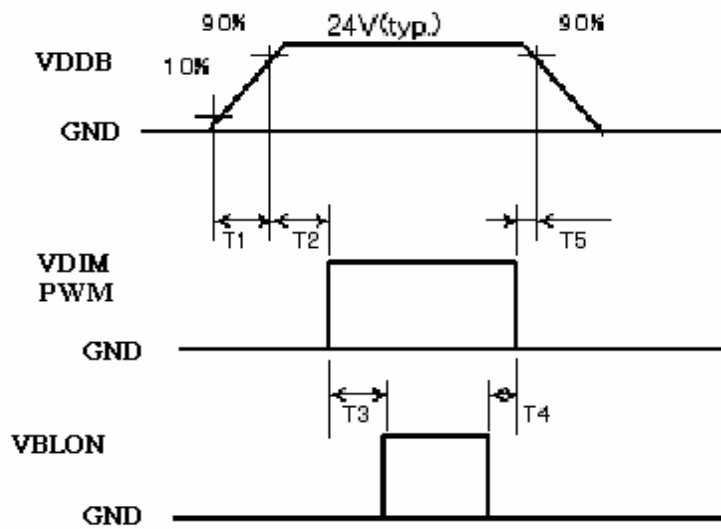

Parameter	Values			Units
	Min.	Typ.	Max.	
T1	20	-	-	ms
T2	50	-	-	ms
T3	0	-	-	ms
T4	0	-	-	ms
T5	0	-	-	ms
T6	-	-	10	ms

## 4. Optical Specification

Optical characteristics are determined after the unit has been 'ON' and stable for approximately 45 minutes in a dark environment at 25°C. The values specified are at an approximate distance 50cm from the LCD surface at a viewing angle of  $\Phi$  and  $\theta$  equal to 0°.

**Fig.1 1 presents additional information concerning the measurement equipment and method.**

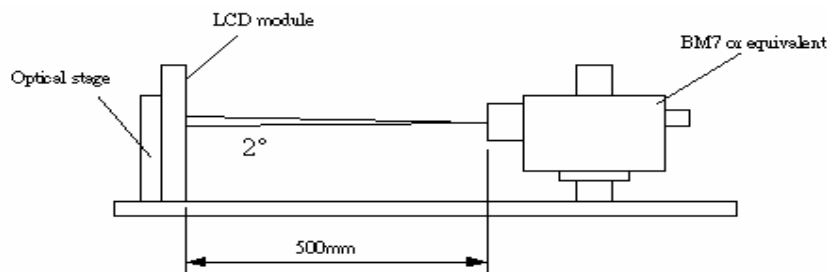

Parameter	Symbol	Values			Units	Notes
		Min.	Typ.	Max.		
Contrast Ratio	CR	800	1000			1
Surface Luminance, white	LWH	400	500		cd/m <sup>2</sup>	2
Luminance Variation	$\delta_{WHITE}$	9 p		1.40		3
Response time	Gray to Gray		$T_{\gamma}$	6	ms	4
Color Coordinates						
	RED	$R_x$		0.64		
		$R_y$		0.33		
	GREEN	$G_x$		0.29		
		$G_y$	Typ.-0.03	0.60	Typ.+0.03	
	BLUE	$B_x$		0.15		
		$B_y$		0.06		
	WHITE	$W_x$		0.28		
		$W_y$		0.29		
Viewing Angle						
	x axis, right ( $\varphi=0^\circ$ )	$\theta_r$		89	Degree	5
	x axis, left ( $\varphi=180^\circ$ )	$\theta_l$		89		
	y axis, up ( $\varphi=90^\circ$ )	$\theta_u$		89		
	y axis, down ( $\varphi=0^\circ$ )	$\theta_d$		89		



**Note:**

1. Contrast Ratio (CR) is defined mathematically as:

$$\text{Contrast Ratio} = \frac{\text{Surface Luminance of } L_{\text{on5}}}{\text{Surface Luminance of } L_{\text{off5}}}$$

2. Surface luminance is luminance value at point 5 across the LCD surface 50cm from the surface with all pixels displaying white. From more information see FIG 2. When  $V_{\text{DDB}} = 24\text{V}$ ,  $I_{\text{DDB}} = 5\text{A}$ .

$$L_{\text{WH}} = L_{\text{on5}}$$

Where  $L_{\text{on5}}$  is the luminance with all pixels displaying white at center 5 location.

3. The variation in surface luminance,  $\delta_{\text{WHITE}}$  is defined (center of Screen) as:

$$\delta_{\text{WHITE(9P)}} = \frac{\text{Maximum}(L_{\text{on1}}, L_{\text{on2}}, \dots, L_{\text{on9}})}{\text{Minimum}(L_{\text{on1}}, L_{\text{on2}}, \dots, L_{\text{on9}})}$$

4. Response time  $T_{\gamma}$  is the average time required for display transition between any two gray scales and is based on  $f_v = 120\text{Hz}$  to optimize. For additional information, please see FIG3.

5. Viewing angle is the angle at which the contrast ratio is greater than 10. The angles are determined for the horizontal or x axis and the vertical or y axis with respect to the z axis which is normal to the LCD surface. For more information see FIG4.

**FIG. 2 Luminance**

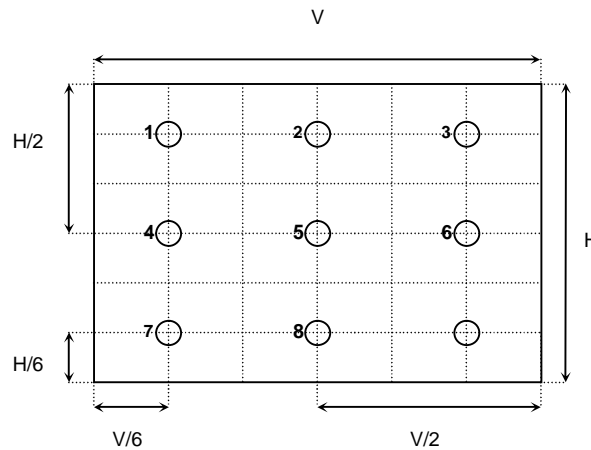

### FIG.3 Response Time

The response time is defined as the following figure and shall be measured by switching the input signal for “any level of gray(bright) “ and “any level of gray(dark)”.

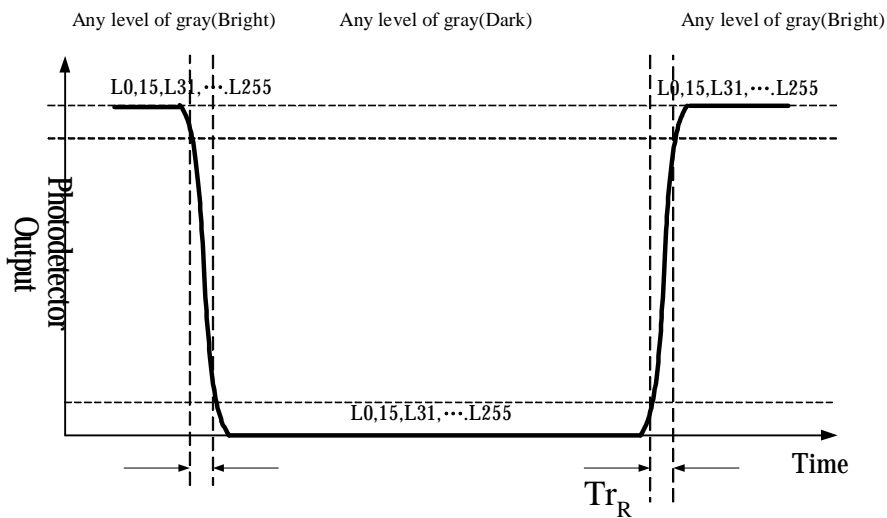

### FIG.4 Viewing angle

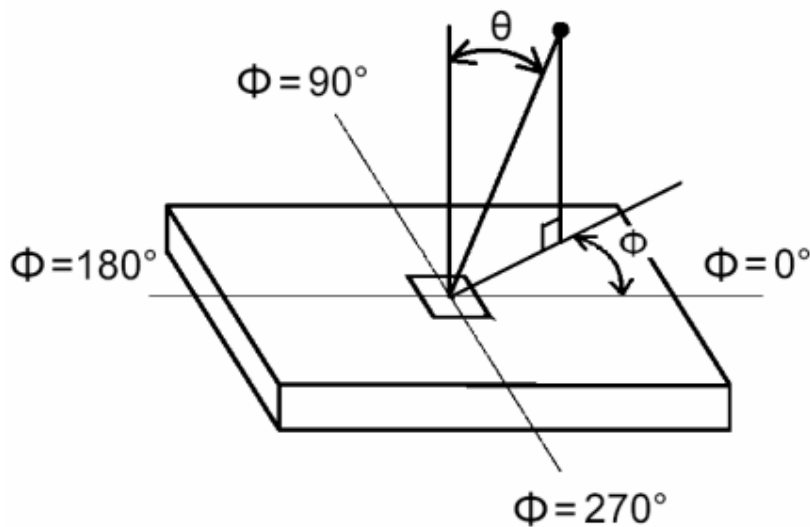



## 5. Mechanical Characteristics

The contents provide general mechanical characteristics for the model T315XW02 V6. In addition the figures in the next page are detailed mechanical drawing of the LCD.

Outline Dimension	Horizontal	760.0mm
	Vertical	450.0mm
	Depth	45mm
Bezel Opening	Horizontal	703.6mm
	Vertical	398.3mm
Active Display Area	Horizontal	697.68mm
	Vertical	392.26mm
Weight	7200g (Typ)	
Surface Treatment	AG, 3H	



Front

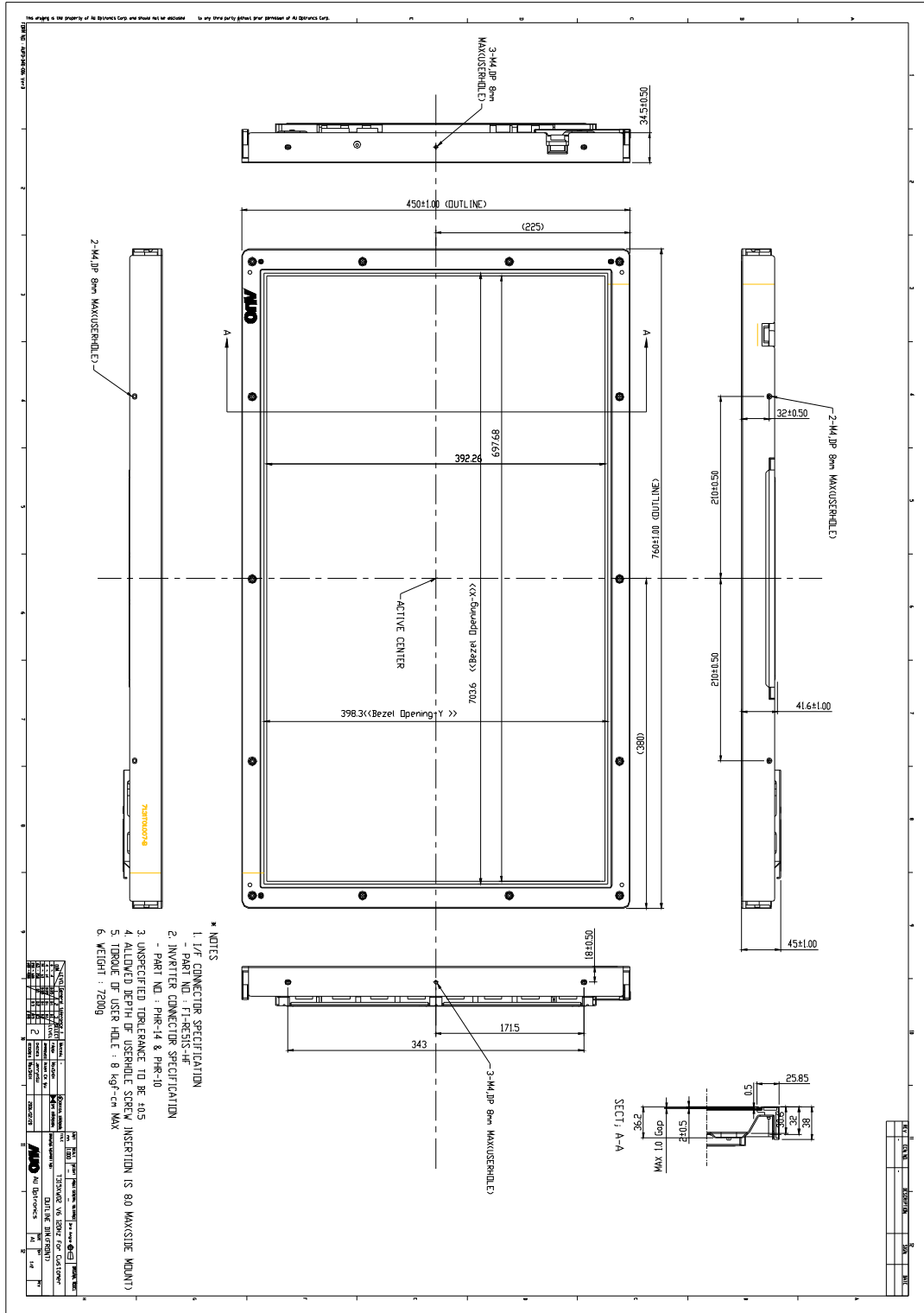



Back

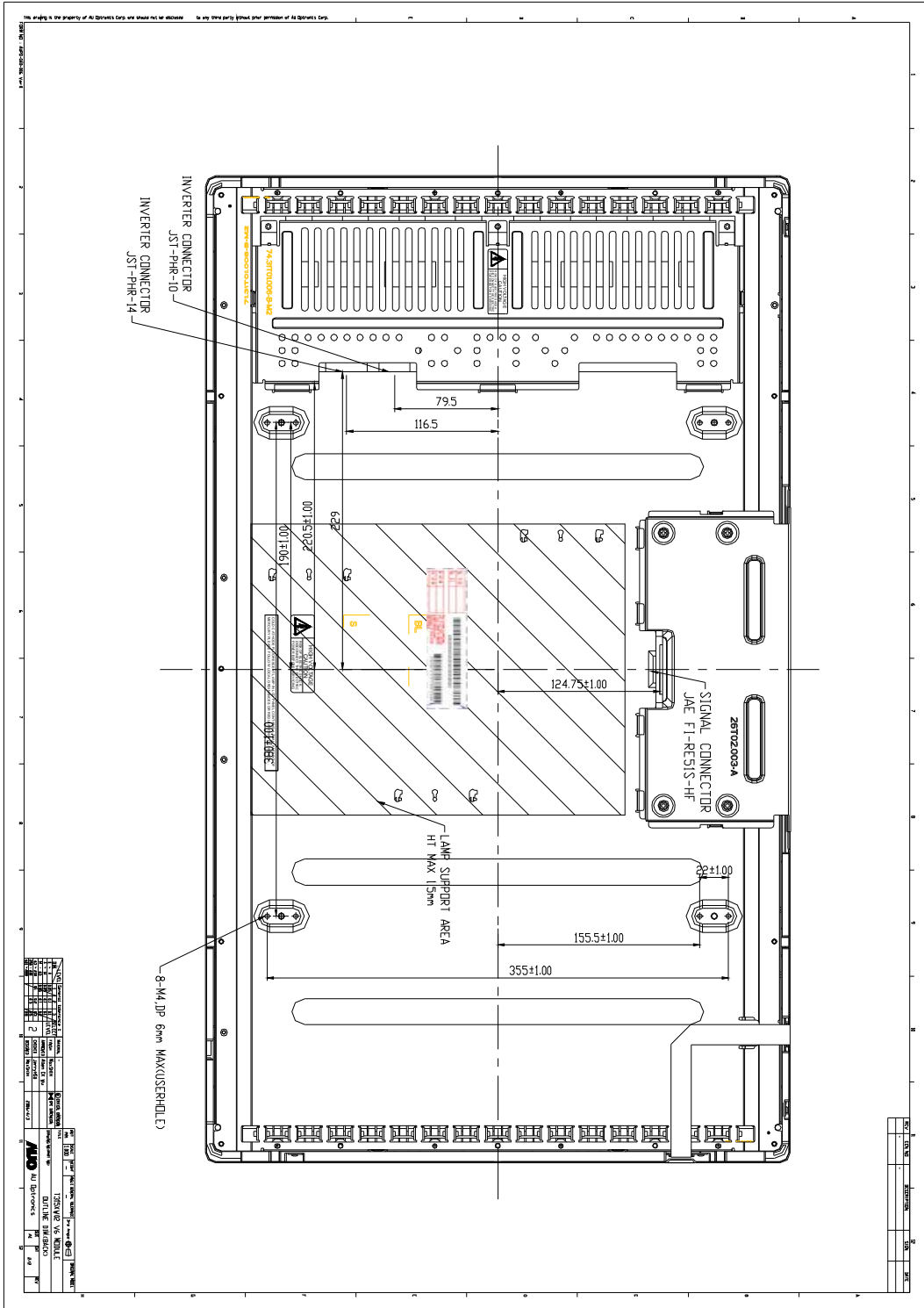



## 6. Reliability

Environment test condition

No	Test Item	Condition
1	High temperature storage test	Ta=60°C 240h
2	Low temperature storage test	Ta=-20°C 240h
3	High temperature operation test	Ta=50°C 80%RH 240h
4	Low temperature operation test	Ta=0°C 240h
5	Vibration test (non-operating)	Wave form: random Vibration level : 1.0G RMS Bandwidth : 10-500Hz Duration: X, Y, Z 20min One time each direction
6	Shock test (non-operating)	Shock level: 50G Waveform: half sine wave, 11ms Direction: ±X, ±Y, ±Z One time each direction
7	Vibration test (with carton)	Random Vibration:10~200Hz,1.5G,30minutes in each X,Y,Z direction
8	Drop test (with carton)	Height: 53.3cm 1 corner, 3 edges, 6 surfaces (ASTMD4169-I)





## 7. International Standard

### 7-1. Safety

(1) UL1950 Third Edition, Underwriters Laboratories, Inc. Jan. 28, 1995

Standard for Safety of Information Technology Equipment Including electrical Business Equipment.

(2) CAN/CSA C22.2 No. 950-95/60950 Third Edition, Canadian Standards Association,

Standard for Safety of Information Technology Equipment Including Electrical Business Equipment.

(3) EN60950 : 1992+A2: 1993+A2: 1993+C3: 1995+A4: 1997+A11: 1997

IEC 950: 1991+A1: 1992+A2: 1993+C3: 1995+A4:1996

European Committee for Electrotechnical Standardization (CENELEC)

EUROPEAN STANDARD for Safety of Information Technology Equipment Including Electrical Business Equipment.

### 7-2. EMC

a) ANSI C63.4 “Methods of Measurement of Radio-Noise Emissions from Low-Voltage Electrical and Electrical Equipment in the Range of 9kHz to 40GHz. “American National standards Institute(ANSI), 1992

b) C.I.S.P.R “Limits and Methods of Measurement of Radio Interface Characteristics of Information Technology Equipment.” International Special committee on Radio Interference.

c) EN 55022 “Limits and Methods of Measurement of Radio Interface Characteristics of Information Technology Equipment.” European Committee for Electrotechnical Standardization. (CENELEC), 1998



## 8. Packing

Panel label:

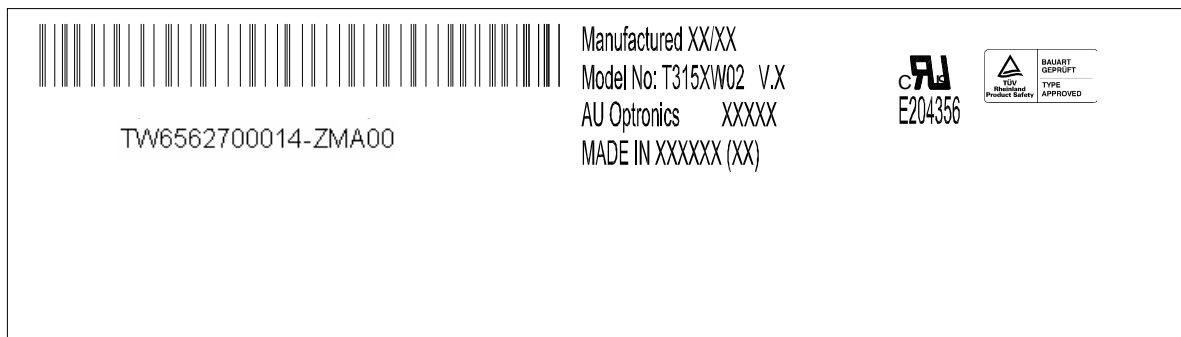

### TW6562700014

TW65627: Production Lot

00014: Panel Serial Number

ZMA: AUO internal code

Manufactured 06/21: 2006 week 21

Made In Taiwan: Taiwan made

Carton Label :

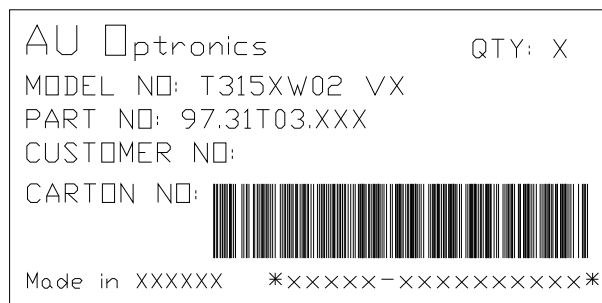



Carton :

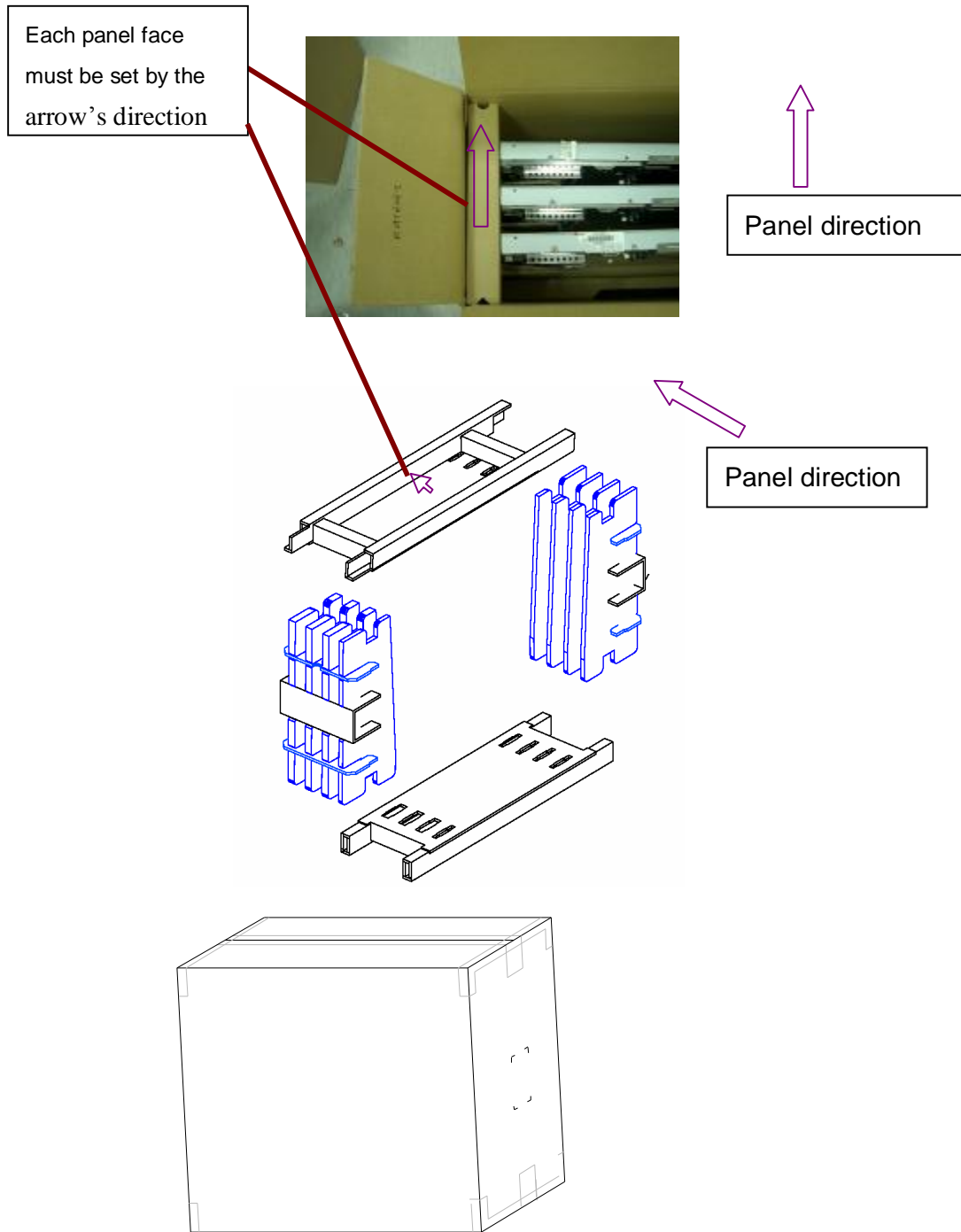

**882(L)mm\*290(W)mm\*585(H)mm**



## 9. PRECAUTIONS

Please pay attention to the followings when you use this TFT LCD module.

### 9-1 MOUNTING PRECAUTIONS

- (1) You must mount a module using holes arranged in four corners or four sides.
- (2) You should consider the mounting structure so that uneven force (ex. Twisted stress) is not applied to module. And the case on which a module is mounted should have sufficient strength so that external force is not transmitted directly to the module.
- (3) Please attach the surface transparent protective plate to the surface in order to protect the polarizer. Transparent protective plate should have sufficient strength in order to resist external force.
- (4) You should adopt radiation structure to satisfy the temperature specification.
- (5) Acetic acid type and chlorine type materials for the cover case are not desirable because the former generates corrosive gas of attacking the polarizer at high temperature and the latter causes circuit break by electro-chemical reaction.
- (6) Do not touch, push or rub the exposed polarizers with glass, tweezers or anything harder than HB pencil lead. And please do not rub with dust clothes with chemical treatment. Do not touch the surface of polarizer for bare hand or greasy cloth. (Some cosmetics are detrimental to the polarizer.)
- (7) When the surface becomes dusty, please wipe gently with absorbent cotton or other soft materials like chamois soaks with petroleum benzene. Normal-hexane is recommended for cleaning the adhesives used to attach front/ rear polarizers. Do not use acetone, toluene and alcohol because they cause chemical damage to the polarizer.
- (8) Wipe off saliva or water drops as soon as possible. Their long time contact with polarizer causes deformations and color fading.
- (9) Do not open the case because inside circuits do not have sufficient strength.

### 9-2 OPERATING PRECAUTIONS

- (1) The spike noise causes the mis-operation of circuits. It should be lower than following voltage:  $V=\pm 200\text{mV}$ (Over and under shoot voltage)
- (2) Response time depends on the temperature. (In lower temperature, it becomes longer.)
- (3) Brightness depends on the temperature. (In lower temperature, it becomes lower.) And in lower temperature, response time (required time that brightness is stable after turned on) becomes longer.
- (4) Be careful for condensation at sudden temperature change. Condensation makes damage to polarizer or electrical contacted parts. And after fading condensation, smear or spot will occur.
- (5) When fixed patterns are displayed for a long time, remnant image is likely to occur.
- (6) Module has high frequency circuits. Sufficient suppression to the electromagnetic interference shall be done by system manufacturers. Grounding and shielding methods may be important to minimize the interface.



### **9-3 ELECTROSTATIC DISCHARGE CONTROL**

Since a module is composed of electronic circuits, it is not strong to electrostatic discharge. Make certain that treatment persons are connected to ground through wrist band etc. And don't touch interface pin directly.

### **9-4 PRECAUTIONS FOR STRONG LIGHT EXPOSURE**

Strong light exposure causes degradation of polarizer and color filter.

### **9-5 STORAGE**

When storing modules as spares for a long time, the following precautions are necessary.

- (1) Store them in a dark place. Do not expose the module to sunlight or fluorescent light. Keep the temperature between 5°C and 35°C at normal humidity.
- (2) The polarizer surface should not come in contact with any other object. It is recommended that they be stored in the container in which they were shipped.

### **9-6 HANDLING PRECAUTIONS FOR PROTECTION FILM**

- (1) The protection film is attached to the bezel with a small masking tape. When the protection film is peeled off, static electricity is generated between the film and polarizer. This should be peeled off slowly and carefully by people who are electrically grounded and with well ion-blown equipment or in such a condition, etc.
- (2) When the module with protection film attached is stored for a long time, sometimes there remains a very small amount of glue still on the Bezel after the protection film is peeled off.
- (3) You can remove the glue easily. When the glue remains on the Bezel or its vestige is recognized, please wipe them off with absorbent cotton waste or other soft material like chamois soaked with normal-hexane.

# MPRT: Moving Picture Response Time

MPRT definition: moving picture response time is the average value of 16\*16 gray to gray table. The table data is measured under 25°C room temperature after 1hour panel warm-up.

Equipment: MPRT-1000 with CCD camera and Galvano Meter Mirror

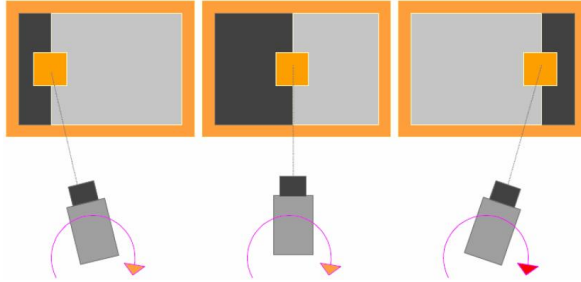

**AUO MPRT measured data: 8.5ms**