



Product Specifications

37.0” HDTV Color TFT-LCD Module Model Name: T370HW01 V.1

**(*) Preliminary Specifications
() Final Specifications**

Note: This Specification is subject to change without notice.



Contents

No	ITEM
	COVER
	CONTENTS
	RECORD OF REVISIONS
1	GENERAL DESCRIPTION
2	ABSOLUTE MAXIMUM RATINGS
3	ELECTRICAL SPECIFICATIONS
3-1	ELECTRICAL CHARACTERISTICS
3-2	INTERFACE CONNECTIONS
3-3	INPUT TIMING SPECIFICATIONS
3-4	SIGNAL TIMING WAVEFORMS
3-5	COLOR INPUT DATA REFERENCE
3-6	POWER SEQUENCE
4	OPTICAL SPECIFICATIONS
5	MECHANICAL CHARACTERISTICS
6	RELIABILITY
7	INTERNATIONAL STANDARDS
7-1	SAFETY
7-2	EMC
8	Packing
9	PRECAUTIONS



1. General Description

This specification applies to the 37.0 inch Color TFT-LCD Module T370HW01. This LCD module has a TFT active matrix type liquid crystal panel 1920x1080 pixels, and diagonal size of 37.0 inch. This module supports 1920x1080 HDTV mode (Non-interlace).

Each pixel is divided into Red, Green and Blue sub-pixels or dots which are arranged in vertical stripes. Gray scale or the brightness of the sub-pixel color is determined with a 8-bit gray scale signal for each dot.

The T370HW01 has been designed to apply the 8-bit 2 channel LVDS interface method. It is intended to support displays where high brightness, wide viewing angle, high color saturation, and high color depth are very important.

* General Information

Items	Specification	Unit	Note
Active Screen Size	37.01	Inches	
Display Area	819.36 (H) x 460.89(V)	mm	
Outline Dimension	894.8(H) x 527.4(V) x 50.72(D)	mm	With inverter
Driver Element	a-Si TFT active matrix		
Display Colors	16.7M	Colors	
Number of Pixels	1920 x 1080	Pixel	
Pixel Arrangement	RGB vertical stripe		
Pixel pitch	0.42675(H) x 0.42675(W)		
Surface Treatment	Hard-Coating (3H), Anti-Glare, Reflectance < 2%		



2. Absolute Maximum Ratings

The following are maximum values which, if exceeded, may cause faulty operation or damage to the unit.

Parameter	Symbol	Min.	Max.	Unit	Note
Logic/LCD Driving Voltage	V_{DD}	10.8	13.2	V.	At 25±5°C
Input Voltage of Signal	V_{in}			V.	
BLU Input Voltage	V_{DDB}	22.8	25.2	V	
BLU Control Voltage	BL_{ON}			V	
Operating Temperature	T_{OP}	00	50	°C	1
Storage Temperature	H_{ST}	-20	60	°C	1
Operating Ambient Humidity	H_{OP}	10	90	%RH	1
Storage Humidity	H_{ST}	10	90	%RH	1

Note: 1. Temperature and relative humidity range are shown in the figure below. Wet bulb temperature should be 39°C

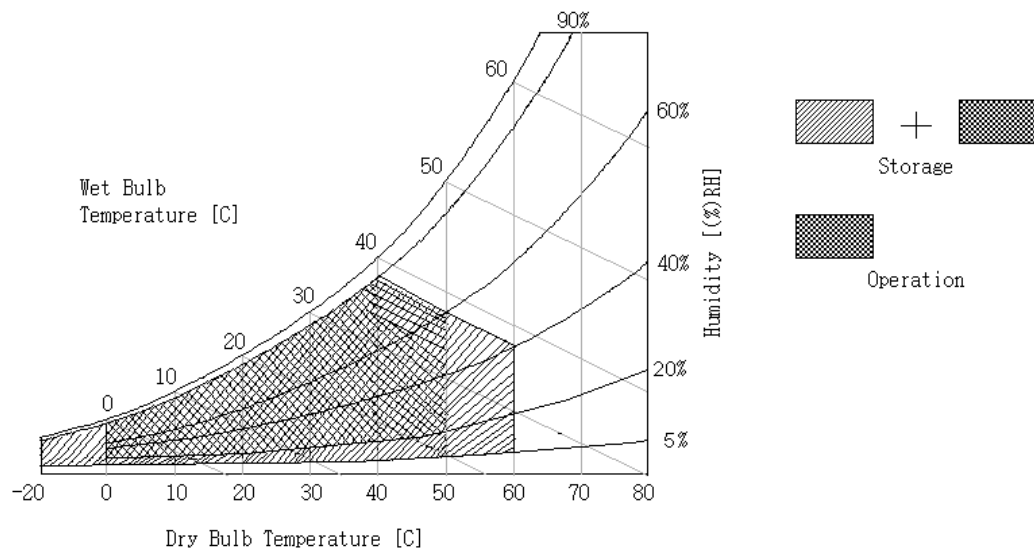



3. Electrical Specification

3-1 Electrical Characteristics

The T370HW01 requires two power inputs. One is employed to power the LCD electronics and to drive the TFT array and liquid crystal. The second input which powers the CCFL, is typically generated by an inverter.

Parameter	Symbol	Values			Unit	Notes
		Min	Typ	Max		
LCD:						
Power Supply Input Voltage	V _{cc}	10.80	12.0	13.20	V _{dc}	
Power Supply Input Current	I _{cc}	-	1.0	1.2	A	1
Power Consumption	P _c	-	12.0	14.4	Watt	1
Inrush Current	I _{RUSH}	-		3	A	
Backlight Power Consumption			163		Watt	2
Life Time		60,000				3

Note:

1. The specified current and power consumption are under the V_{cc}=12.0V, 25 °C, f_v= 60Hz, f_{CLK}=65Mhz condition whereas mosaic pattern (8x6) is displayed and f_v is the frame frequency.
2. The lamp power consumption shown above does include loss of external inverter at 25 °C.
The used lamp current is the lamp typical current
3. The life is determined as the time at which luminance of the lamp is 50% compared to that of initial value at the typical lamp current on condition of continuous operating at 25±2°C

Note:

The design of the inverter must have specifications for the lamp in LCD Assembly. The performance of the Lamp in LCM, for example lifetime or brightness, is extremely influenced by the characteristics of the DC-AC Inverter. So all the parameters of an inverter should be carefully designed so as not to produce too much leakage current from high-voltage output of the inverter. When you design or order the inverter, please make sure unwanted lighting caused by the mismatch of the lamp and the inverter (no lighting, flicker, etc) never occurs. When you confirm it, the LCD Assembly should be operated in the same condition as installed in your instrument.

Do not attach a conducting tape to lamp connecting wire. If the lamp wire attach to conducting tape, TFT-LCD Module have a low luminance and the inverter has abnormal action because leakage current occurs between lamp wire and conducting tape.

The relative humidity must not exceed 80% non-condensing at temperatures of 40°C or less. At temperatures greater than 40°C, the wet bulb temperature must not exceed 39°C. When operate at low temperatures, the brightness of CCFL will drop and the lifetime of CCFL will be reduced.

The output of the inverter must have symmetrical (negative and positive) voltage waveform and symmetrical current waveform (Asymmetry ratio is less than 10%). Please do not use the inverter that has asymmetrical voltage and asymmetrical current and spike wave. Requirements for a system inverter design which is intended to have a better display performance, a better power efficiency and a more reliable lamp. It shall help increase the lamp lifetime and reduce its leakage current.



- a. The asymmetry rate of the inverter current and voltage waveform should be 10% below;
- b. The distortion rate of the current and voltage waveform should be within $\sqrt{2}\pm 10\%$;
- c. The ideal sine current and voltage waveform shall be symmetric in positive and negative polarities.

3-2 Interface Connections

LCD Connector (CN1): FI-WE41P-HF(JAE) or equivalent

LVDS Transmitter:

PIN #	Spec NAME	DESCRIPTION / Reserve function	21	RxE1-	Negative LVDS data input (Even data)
1	POWER	12V Power Input	22	RxE0+	Positive LVDS data input (Even data)
2	POWER	12V Power Input	23	RxE0-	Negative LVDS data input (Even data)
3	POWER	12V Power Input	24	GND	Power Ground
4	POWER	12V Power Input	25	NC	No Connecting Pin*
5	GND	Power Ground	26	NC	No Connecting Pin*
6	GND	Power Ground	27	RxO3+	Positive LVDS data input (Odd data)
7	GND	Power Ground	28	RxO3-	Negative LVDS data input (Odd data)
8	NC	No Connecting Pin*	29	RxOC+	Positive LVDS clock input (Odd clock)
9	NC	No Connecting Pin*	30	RxOC-	Negative LVDS clock input (Odd clock)
10	GND	Power Ground	31	GND	Power Ground
11	NC	No Connecting Pin*	32	RxO2+	Positive LVDS data input (Odd data, HS, VS, DE)
12	NC	No Connecting Pin*	33	RxO2-	Negative LVDS data input (Odd data, HS, VS, DE)
13	RxE3+	Positive LVDS data input (Even data)	34	RxO1+	Positive LVDS data input (Odd data)
14	RxE3-	Negative LVDS data input (Even data)	35	RxO1-	Negative LVDS data input (Odd data)
15	RxEC+	Positive LVDS clock input (Even clock)	36	RxO0+	Positive LVDS data input (Odd data)
16	RxEC-	Negative LVDS clock input (Even clock)	37	RxO0-	Negative LVDS data input (Odd data)
17	GND	Power Ground	38	GND	Power Ground
18	RxE2+	Positive LVDS data input (Even data)	39	NC	No Connecting Pin*
19	RxE2-	Negative LVDS data input (Even data)	40	NC	No Connecting Pin*
20	RxE1+	Positive LVDS data input (Even data)	41	NC	No Connecting Pin*

*NC Only – Pull High or Low is not allowed

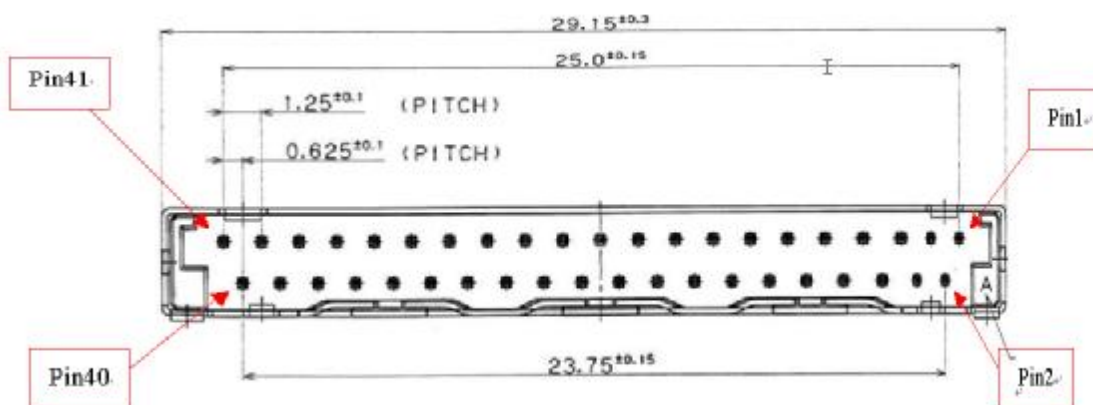

Note: All GND (ground) pins should be connected together and also be connected to the LCD's metal frame.
All Vcc (power input) pins should be connected together.



I LVDS Order

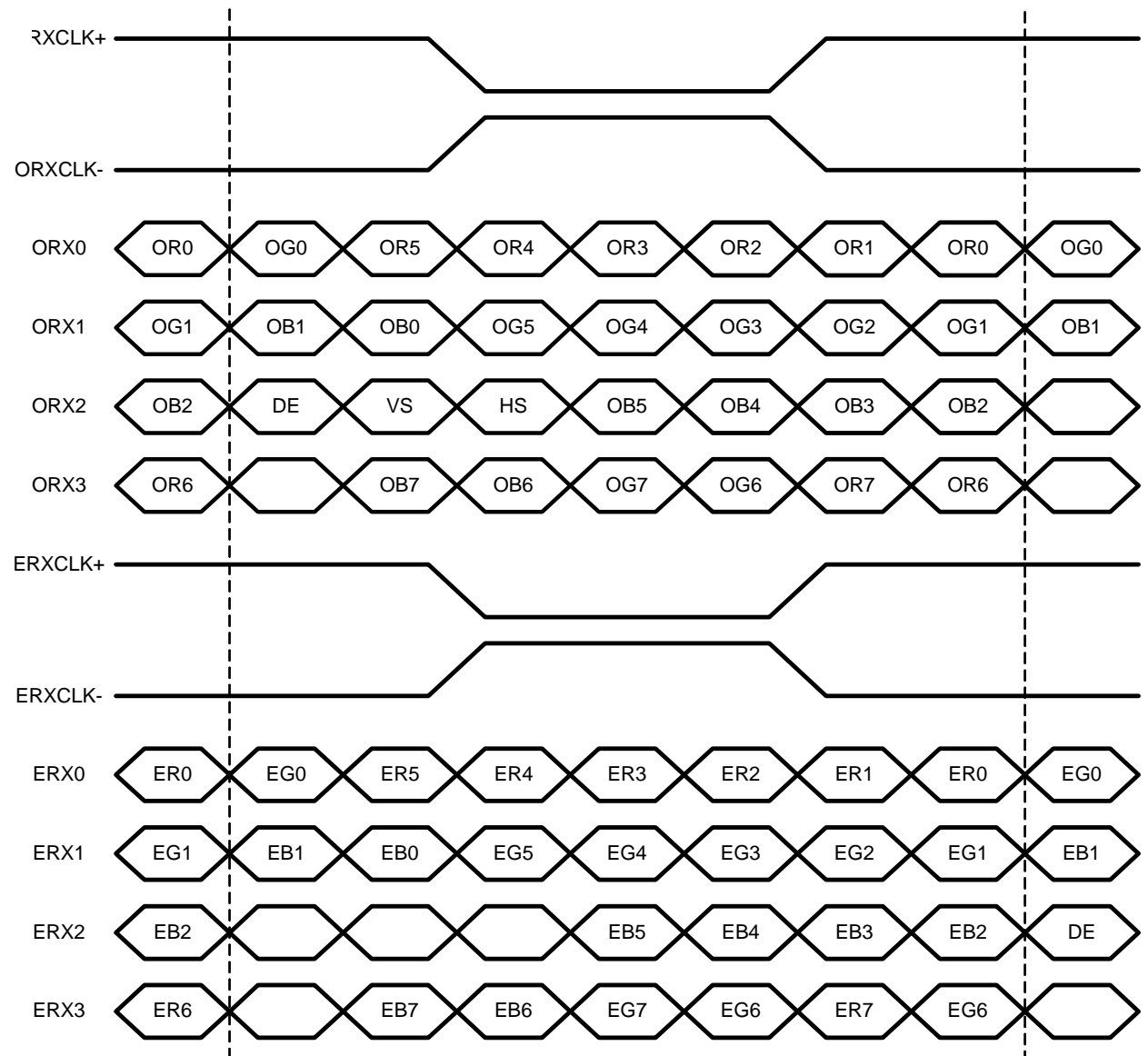



I BACKLIGHT CONNECTOR PIN CONFIGURATION -

1. Electrical specification

(Ta=25±5°C)

No	Item	Symbol	Test Condition	Min	Typ	Max	Unit	Note	
1	Input Voltage	Vin		21.6	24	26.4	V		
2	Input Current	Iin	VDD=24V,DimMax	-	6.8-	8.8	A		
3	Input Power	Pin	VDD=24V,DimMax	-	163.2-	211.2	W	*4	
4	Output Working Voltage	VL *2	VDD=24V,DimMax	-	1400	-	Vrms		
5	Oscillating Frequency	FO	VDD=24V,DimMax	64	67	70	kHz		
6	On/Off Control Voltage	On	BLON	VDD=24V	2	-	5	V	
		Off	BLON	VDD=24V	0	-	0.8	V	
7	Analog Dimming Control *1	Max	Vdim	VDD=24V	-	0	-	V	
		Min	Vdim	VDD=24V	4.75	5	5.25	V	50% Luminanc
8	PWM Dimming Control *2	Max	Vdim	VDD=24V	-	100	-	%	
		Min	Vdim	VDD=24V	-	30	-	%	Duty Ratio
9	Dimming Frequency	FB	VDD=24V	150	-	300	Hz		

※1: Connection of brightness control terminal

Bright control by the voltage

5.0V : Min. brightness

0V : Max. brightness

※2: Connection of brightness control terminal

※3: BLON Logic

H(5V) : Back Light ON

L (0V) : Back Light OFF

OPEN : Back Light OFF

※4: Inverter Current Curve (from Turn-on Inrush to thermal equilibrium)

	typ	max	unit
I _p	8.0	8.8	A.
I	6.8		A.
T	30	60	min

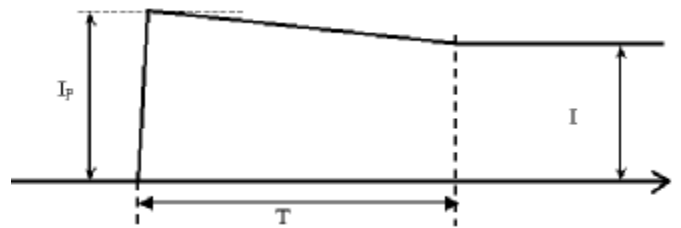

3. Input specification

©Copyright AU Optronics, Inc.

March, 2004 All Rights Reserved.

No Reproduction and Redistribution Allowed

T370HW01 V.1 Ver0.0

9/25



CN1 : S14B-PH-SM3-TB(JST)

No	Signal Name	Feature
1	V _{DD}	+24V
2	V _{DD}	+24V
3	V _{DD}	+24V
4	V _{DD}	+24V
5	V _{DD}	+24V
6	GND	GND
7	GND	GND
8	GND	GND
9	GND	GND
10	GND	GND
11	Anologe Dim	External Analog Dimming Control
12	BL On/Off	On/Off Control
13	PWM Dim	External PWM Dimming Control
14	NC	No Connecting Pin / NC Only

CN2 : S10B-PH-SM3-TB(JST)

No	Signal Name	Feature
1	V _{DD}	+24V
2	V _{DD}	+24V
3	V _{DD}	+24V
4	V _{DD}	+24V
5	V _{DD}	+24V
6	GND	GND
7	GND	GND
8	GND	GND
9	GND	GND
10	GND	GND

CN3 & CN4 same as CN2

Connector position pls refer to P.19 drawing

3-3 Input Timing Specifications

This is the signal timing required at the input of the User connector. All of the interface signal timing should be satisfied with the following specifications for it's proper operation.

I Timing Table (DE only node)

A. Frame Rate = 60 Hz

Signal	Item	Symbol	Min.	Typ.	Max.	Unit
Vertical Section	Period	TV	1090	1130	1200	Th
	Active	Tdisp(V)	1080	1080	1080	Th
	Blanking	Tblk(V)	10	50	120	Th
Horizontal Section	Period	Th	1010	1100	1180	Tclk
	Active	Tdisp(h)	960	960	960	Tclk
	Blanking	Tblk(h)	50	140	220	Tclk
	Period	Tclk				Ns
Clock	Frequency	Freq	68	74.58	82	MHz
Vertical Frequency		Freq.	58	60	62	Hz
Horizontal Frequency		Freq.	65	67.8	72	KHz



B. Frame Rate = 50 Hz

Signal	Item	Symbol	Min.	Typ.	Max.	Unit
Vertical Section	Period	TV	1090	1130	1200	Th
	Active	Tdisp(V)	1080	1080	1080	Th
	Blanking	Tblk(V)	10	50	120	Th
Horizontal Section	Period	Th	1010	1100	1180	Tclk
	Active	Tdisp(h)	960	960	960	Tclk
	Blanking	Tblk(h)	50	140	220	Tclk
	Period	Tclk				ns
Clock	Frequency	Freq	68	75	78	MHz
Vertical Frequency		Freq.	48	50	52	Hz
Horizontal Frequency		Freq.	65	67.8	72	KHz



3-4 Signal Timing Waveforms

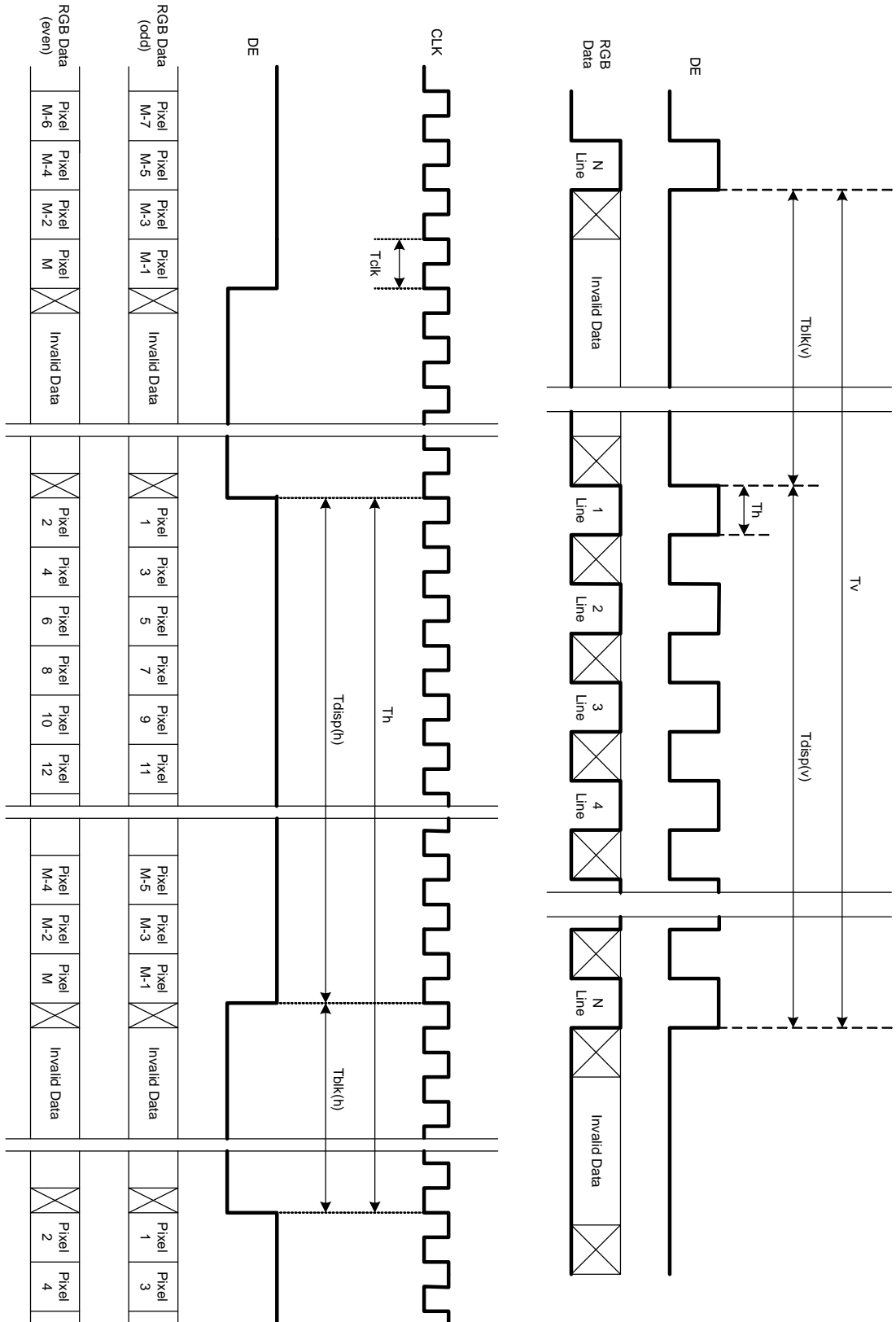



3-5 Color Input Data Reference

The brightness of each primary color (red, green and blue) is based on the 8 bit gray scale data input for the color; the higher the binary input, the brighter the color. The table below provides a reference for color versus data input.

COLOR DATA REFERENCE

Color		Input Color Data																							
		RED								GREEN								BLUE							
		MSB				LSB				MSB				LSB				MSB				LSB			
		R7	R6	R5	R4	R3	R2	R1	R0	G7	G6	G5	G4	G3	G2	G1	G0	B7	B6	B5	B4	B3	B2	B1	B0
Basic Color	Black	0	0	0	0	0	0	0	0	0	0	0	0	0	0	0	0	0	0	0	0	0	0	0	0
	Red(255)	1	1	1	1	1	1	1	1	0	0	0	0	0	0	0	0	0	0	0	0	0	0	0	0
	Green(255)	0	0	0	0	0	0	0	0	1	1	1	1	1	1	1	1	0	0	0	0	0	0	0	0
	Blue(255)	0	0	0	0	0	0	0	0	0	0	0	0	0	0	0	0	1	1	1	1	1	1	1	1
	Cyan	0	0	0	0	0	0	0	0	1	1	1	1	1	1	1	1	1	1	1	1	1	1	1	1
	Magenta	1	1	1	1	1	1	1	1	0	0	0	0	0	0	0	0	1	1	1	1	1	1	1	1
	Yellow	1	1	1	1	1	1	1	1	1	1	1	1	1	1	1	1	0	0	0	0	0	0	0	0
White	1	1	1	1	1	1	1	1	1	1	1	1	1	1	1	1	1	1	1	1	1	1	1	1	
RED	RED(000)	0	0	0	0	0	0	0	0	0	0	0	0	0	0	0	0	0	0	0	0	0	0	0	0
	RED(001)	0	0	0	0	0	0	0	0	0	0	0	0	0	0	0	0	0	0	0	0	0	0	0	0

	RED(254)	1	1	1	1	1	1	1	0	0	0	0	0	0	0	0	0	0	0	0	0	0	0	0	0
	RED(255)	1	1	1	1	1	1	1	1	0	0	0	0	0	0	0	0	0	0	0	0	0	0	0	0
GREEN	GREEN(000)	0	0	0	0	0	0	0	0	0	0	0	0	0	0	0	0	0	0	0	0	0	0	0	0
	GREEN(001)	0	0	0	0	0	0	0	0	0	0	0	0	0	0	1	0	0	0	0	0	0	0	0	0

	GREEN(254)	0	0	0	0	0	0	0	0	1	1	1	1	1	1	1	0	0	0	0	0	0	0	0	0
	GREEN(255)	0	0	0	0	0	0	0	0	1	1	1	1	1	1	1	1	0	0	0	0	0	0	0	0
BLUE	BLUE(000)	0	0	0	0	0	0	0	0	0	0	0	0	0	0	0	0	0	0	0	0	0	0	0	0
	BLUE(001)	0	0	0	0	0	0	0	0	0	0	0	0	0	0	0	0	0	0	0	0	0	0	0	1

	BLUE(254)	0	0	0	0	0	0	0	0	0	0	0	0	0	0	0	1	1	1	1	1	1	1	1	0
	BLUE(255)	0	0	0	0	0	0	0	0	0	0	0	0	0	0	0	1	1	1	1	1	1	1	1	1



3-6 Power Sequence

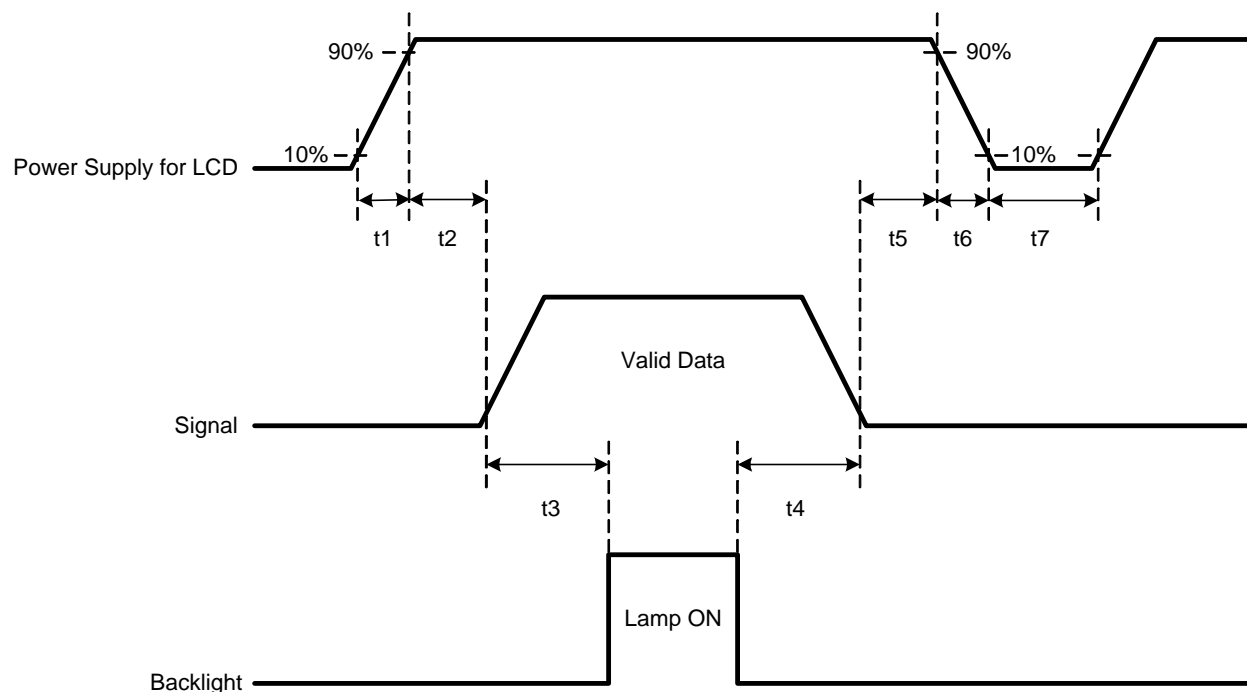

Parameter	Values			Units
	Min.	Typ.	Max.	
t1	470	-	1000	us
t2	20	-	35	ms
t3	200	-	-	ms
t4	200	-	-	ms
t5	5	-	-	ms
t6		-	30	ms
t7	1	-	-	s

Note: User should follow the power on/off sequence and the rising/falling time to avoid miss operation of the panel.

4. Optical Specification

Optical characteristics are determined after the unit has been 'ON' and stable for approximately 30 minutes in a dark environment at 25°C. The values specified are at an approximate distance 50cm from the LCD surface at a viewing angle of Φ and θ equal to 0°.

Fig.1 1 presents additional information concerning the measurement equipment and method.

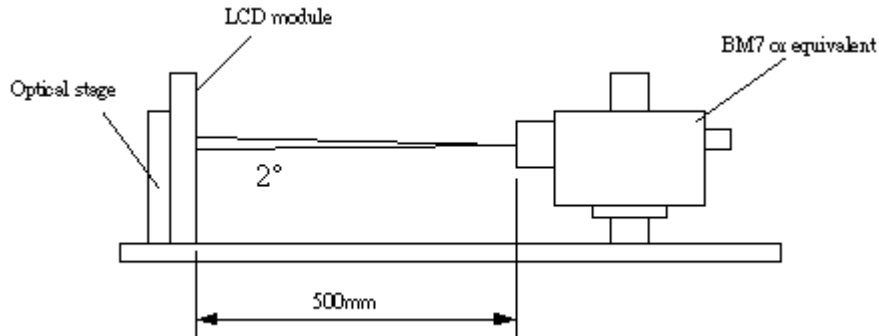

Parameter	Symbol	Values			Units	Notes	
		Min.	Typ.	Max.			
Contrast Ratio	CR		800			1	
Surface Luminance, white	LWH	450	550		cd/m ²	2	
Luminance Variation	δ_{WHITE} 9 p			1.3		3	
Response Time	Gray to Gray		8		ms		
	Tr		15				
	Tf		6				
Color Chromaticity	RED	R _X	Typ -0.03	0.640	Typ +0.03		
		R _Y		0.330			
	GREEN	G _X		0.280			
		G _Y		0.600			
	BLUE	B _X		0.150			
		B _Y		0.060			
	WHITE	W _X		0.280			
		W _Y		0.290			
Viewing Angle							
	x axis, right($\varphi=0^\circ$)	θ_r		85		Degree	5
	x axis, left($\varphi=180^\circ$)	θ_l		85			
	y axis, up($\varphi=90^\circ$)	θ_u		85			
	y axis, down ($\varphi=0^\circ$)	θ_d		85			



Note: 1. Contrast Ratio (CR) is defined mathematically as:

$$\text{Contrast Ratio} = \frac{\text{Surface Luminance with all white pixels}}{\text{Surface Luminance with all black pixels}}$$

2. Surface luminance is luminance value at point 1 across the LCD surface 50cm from the surface with all pixels displaying white. From more information see FIG 2.
3. The variation in surface luminance, $\delta_{\text{WHITE(5P)}}$ is defined (center of Screen) as:

$$\delta_{\text{WHITE(5P)}} = \frac{\text{Maximum}(L_{\text{on1}}, L_{\text{on2}}, \dots, L_{\text{on9}})}{\text{Minimum}(L_{\text{on1}}, L_{\text{on2}}, \dots, L_{\text{on9}})}$$
 More information pls see Fig.3
4. Response time is the time required for the display to transition from white to black (Rise Time, T_{R}) and from black to white (Decay Time, T_{D}). For additional information see FIG4.
5. Viewing angle is the angle at which the contrast ratio is greater than 10. The angles are determined for the horizontal or x axis and the vertical or y axis with respect to the z axis which is normal to the LCD surface. For more information see FIG5.

FIG. 2 Luminance

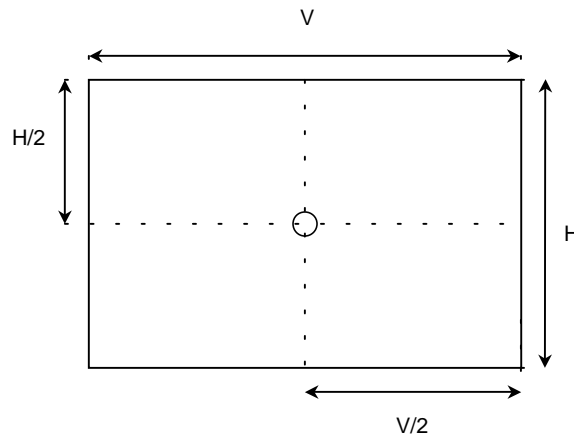

FIG. 3 Luminance variation

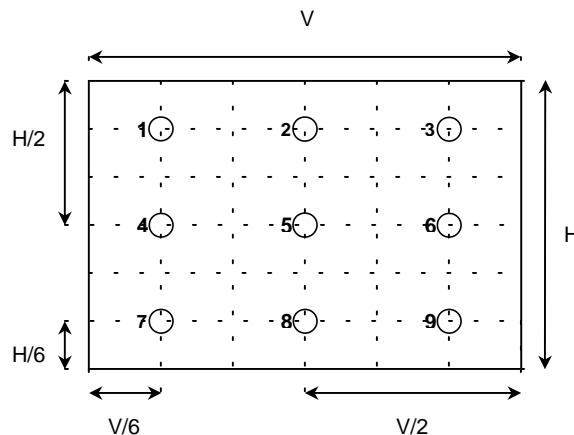



FIG.4 Response Time

The response time is defined as the following figure and shall be measured by switching the input signal for “black” and “white”.

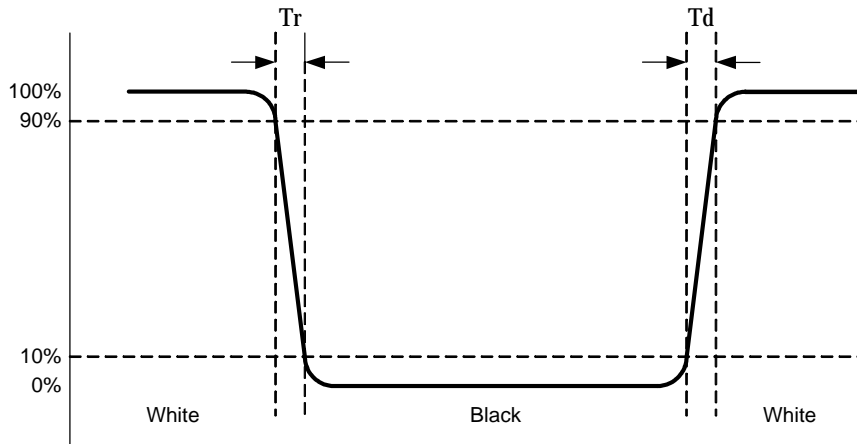
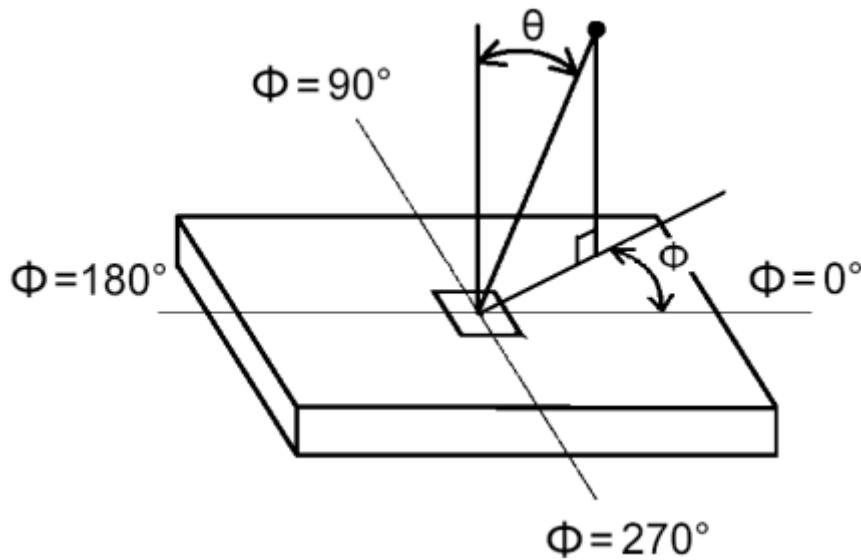

FIG.4 Viewing angle





6. Mechanical Characteristics

The contents provide general mechanical characteristics for the model T460HW01. In addition the figures in the next page are detailed mechanical drawing of the LCD.

Outline Dimension	Horizontal	894.8 mm
	Vertical	527.4 mm
	Depth	50.7 mm(with inverter)
Bezel Opening Area	Horizontal	827.8 mm
	Vertical	470.8 mm
Display Active Area	Horizontal	819.36 mm
	Vertical	460.89 mm
Weight	9500g (Typ.)	
Surface Treatment	Hard-Coating (3H), Anti-Glare, Reflectance < 2%	



2-D Drawing

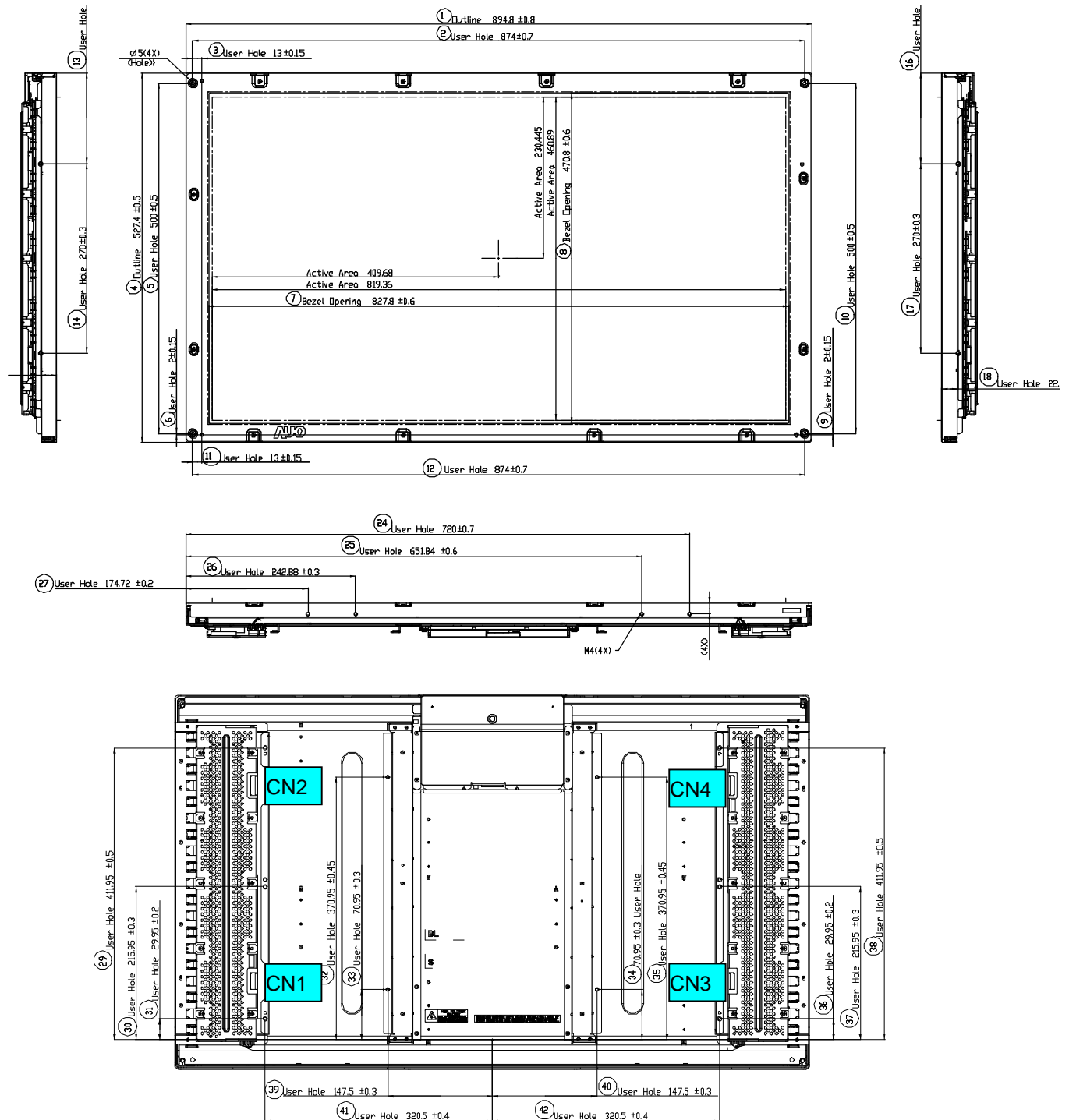



6. Reliability

Environment test condition

No	Test Item	Condition
1	High temperature storage test	Ta=60°C 240h
2	Low temperature storage test	Ta= -20°C 240h
3	High temperature operation test	Ta=50°C 50%RH 240h
4	Low temperature operation test	Ta=0°C 240h
5	Vibration test (non-operating)	Wave form: random Vibration level: 1.5G RMS Bandwidth: 10-300Hz, Sweep time: 10min Duration: X, Y, Z 30min One time each direction
6	Shock test (non-operating)	Shock level: 50G Waveform: half sine wave, 11ms Direction: ±X, ±Y, ±Z One time each direction
7	Vibration test (with carton)	TBD
8	Altitude Storage/shipment	TBD

{ Result Evaluation Criteria }

There should be no change which might affect the practical display function when the display quality test is conducted under normal operating condition.



7. International Standard

7-1. Safety

1. UL 60950, Third Edition, Underwriters Laboratories, Inc. Dec. 11, 2000.

Standard for Safety of Information Technology Equipment, including Electrical Business Equipment.

2. CAN/CSA C22.2 No. 60950, Third Edition, Canadian Standards Association, Dec. 1, 2000

Standard for Safety of Information Technology Equipment Including Electrical Business Equipment.

3. EN60950: 2000, Third Edition

IEC 60950:1999, Third Edition

European Committee for Electrotechnical Standardization (CENELEC)

EUROPEAN STANDARD for Safety of Information Technology Equipment Including Electrical Business Equipment.

7-2. EMC

- a) ANSI C63.4 “Methods of Measurement of Radio-Noise Emissions from Low-Voltage Electrical and Electrical Equipment in the Range of 9kHz to 40GHz. “American National standards Institute (ANSI), 1992
- b) C.I.S.P.R “Limits and Methods of Measurement of Radio Interface Characteristics of Information Technology Equipment.” International Special committee on Radio Interference.
- c) EN 55022 “Limits and Methods of Measurement of Radio Interface Characteristics of Information Technology Equipment.” European Committee for Electrotechnical Standardization. (CENELEC), 1998



7. Packing

- i. Label Sample
TBD
- ii. Carton Label
TBD
- iii. Carton Size
TBD



8. PRECAUTIONS

Please pay attention to the followings when you use this TFT LCD module.

9-1 MOUNTING PRECAUTIONS

- (1) You must mount a module using holes arranged in four corners or four sides.
- (2) You should consider the mounting structure so that uneven force (ex. Twisted stress) is not applied to module. And the case on which a module is mounted should have sufficient strength so that external force is not transmitted directly to the module.
- (3) Please attach the surface transparent protective plate to the surface in order to protect the polarizer. Transparent protective plate should have sufficient strength in order to resist external force.
- (4) You should adopt radiation structure to satisfy the temperature specification.
- (5) Acetic acid type and chlorine type materials for the cover case are not desirable because the former generates corrosive gas of attacking the polarizer at high temperature and the latter causes circuit break by electro-chemical reaction.
- (6) Do not touch, push or rub the exposed polarizers with glass, tweezers or anything harder than HB pencil lead. And please do not rub with dust clothes with chemical treatment. Do not touch the surface of polarizer for bare hand or greasy cloth. (Some cosmetics are detrimental to the polarizer.)
- (7) When the surface becomes dusty, please wipe gently with absorbent cotton or other soft materials like chamois soaks with petroleum benzene. Normal-hexane is recommended for cleaning the adhesives used to attach front/ rear polarizers. Do not use acetone, toluene and alcohol because they cause chemical damage to the polarizer.
- (8) Wipe off saliva or water drops as soon as possible. Their long time contact with polarizer causes deformations and color fading.
- (9) Do not open the case because inside circuits do not have sufficient strength.

9-2 OPERATING PRECAUTIONS

- (1) The spike noise causes the mis-operation of circuits. It should be lower than following voltage:
 $V = \pm 200\text{mV}$ (Over and under shoot voltage)
- (2) Response time depends on the temperature. (In lower temperature, it becomes longer.)
- (3) Brightness depends on the temperature. (In lower temperature, it becomes lower.) And in lower temperature, response time (required time that brightness is stable after turned on) becomes longer.
- (4) Be careful for condensation at sudden temperature change. Condensation makes damage to polarizer or electrical contacted parts. And after fading condensation, smear or spot will occur.
- (5) When fixed patterns are displayed for a long time, remnant image is likely to occur.
- (6) Module has high frequency circuits. Sufficient suppression to the electromagnetic interference shall be done by system manufacturers. Grounding and shielding methods may be important to minimize the interface.

9-3 ELECTROSTATIC DISCHARGE CONTROL

Since a module is composed of electronic circuits, it is not strong to electrostatic discharge. Make certain that treatment persons are connected to ground through wrist band etc. And don't touch interface pin directly.



9-4 PRECAUTIONS FOR STRONG LIGHT EXPOSURE

Strong light exposure causes degradation of polarizer and color filter.

9-5 STORAGE

When storing modules as spares for a long time, the following precautions are necessary.

- (1) Store them in a dark place. Do not expose the module to sunlight or fluorescent light. Keep the temperature between 5°C and 35°C at normal humidity.
- (2) The polarizer surface should not come in contact with any other object. It is recommended that they be stored in the container in which they were shipped.

9-6 HANDLING PRECAUTIONS FOR PROTECTION FILM

- (1) The protection film is attached to the bezel with a small masking tape. When the protection film is peeled off, static electricity is generated between the film and polarizer. This should be peeled off slowly and carefully by people who are electrically grounded and with well ion-blown equipment or in such a condition, etc.
- (2) When the module with protection film attached is stored for a long time, sometimes there remains a very small amount of glue still on the bezel after the protection film is peeled off.
- (3) You can remove the glue easily. When the glue remains on the bezel or its vestige is recognized, please wipe them off with absorbent cotton waste or other soft material like chamois soaked with normal-hexane.