



Product Description: T370HW02_V1 TFT-LCD PANEL	
AUO Model Name: T370HW02_V1	
Customer Part No/Project Name:	
Customer Signature	Date
AUO	Date



Update date: 2007/05/14

Product Specifications

**37" HDTV Color TFT-LCD Module
Model Name: T370HW02. V1**

**() Preliminary Specifications
(*) Final Specifications**



Contents

No	
	CONTENTS
	RECORD OF REVISIONS
1	GENERAL DESCRIPTION
2	ABSOLUTE MAXIMUM RATINGS
4	ELECTRICAL CHARACTREISTICS
4-1	TFT-LCD MODULE
4-2	BACKLIGHT UNIT
4-3	LVDS DATA FORMAT
5	INPUT TERMINAL PIN ASSIGNMENT
5-1	TFT-LCD MODULE
5-2	INVERTER UNIT
5-3	LVDS DATA FORMAT
5-4	COLOR DATA INPUT ASSIGNMENT
6	INTERFACE TIMING CHARACTERISTICS
7	OPTICAL CHARACTERISTICS
8	MECHANICAL CHARACTERISTICS
9	RELIABLITY
10	INTERNATIONAL STANDARDS
10-1	SAFETY
10-2	EMC
11	PACKING
11-1	LABEL DEFINITION
11-2	PACKING METHODS & SPECIFICATIONS
12	PRECAUTIONS
	Appendix A



Record of Revision

Version	Date	No	Old Description	New Description	Remark
0.1	2006.07.1 1	1	LVDS Order High (3.3V)= JETDA Low (GND) or Open =NS	LVDS Order Low (GND) or Open =NS High (3.3V)= JETDA	Page.12
0.2	2006.07.1 1	2	Common input voltage: 1.0V/ 1.2V/1.5V	Common input voltage: 1.1V/ 1.25V/1.4V	Page.6
0.3	2006.07.1 1	3	Storage temperature: -20~9 0°C	Storage temperature: -20 ~65°C	Page.5
0.4	2006.08.2 3	4	Max of the T1 in LVDS signal = 1000 us	Max of the T1 in LVDS signal = 5000 us	Page 16



1. General Description

This specification applies to the 37.0 inch Color TFT-LCD Module T370HW02 V1. This LCD module has a TFT active matrix type liquid crystal panel 1920x1080 pixels, and diagonal size of 37.0 inch. This module supports 1920x1080 HDTV mode (Non-interlace). Each pixel is divided into Red, Green and Blue sub-pixels or dots which are arranged in vertical stripes. Gray scale or the brightness of the sub-pixel color is determined with a 8-bit gray scale signal for each dot.

The T370HW02 V1 has been designed to apply the 8-bit 2 channel LVDS interface method. It is intended to support displays where high brightness, wide viewing angle, high color saturation, and high color depth are very important.

* General Information

Items	Specification	Unit	Note
Active Screen Size	37.01	inch	
Display Area	819.36 (H) x 460.89(V)	mm	
Outline Dimension	877(H) x 514.6(V) x 54.7(D)	mm	With inverter
Driver Element	a-Si TFT active matrix		
Display Colors	8 bit, 16.7M	Colors	
Number of Pixels	1920 x 1080	Pixel	
Pixel Pitch	0.42675(H) x 0.42675(W)	mm	
Pixel Arrangement	RGB vertical stripe		
Display Operation Mode	Transmissive, Normally Black		
Surface Treatment	Hard-Coating (3H), Anti-Glare		



2. Absolute Maximum Ratings

The following are maximum values that, if exceeded, may cause permanent damage to the device.

Item	Symbol	Min	Max	Unit	Note
Logic/LCD Drive Voltage	Vcc	-0.3	14	[Volt]	[1]
Input Voltage of Signal	Vin	-0.3	4	[Volt]	[1]
BLU Input Voltage	VDDB	-0.3	27	[Volt]	[1]
BLU Brightness Control Voltage	VBON	-0.3	7.0	[Volt]	[1]
Operating Temperature	TOP	0	50	[°C]	[2]
Operating Humidity	HOP	10	90	[%RH]	[2]
Storage Temperature	TST	-20	65	[°C]	[2]
Storage Humidity	HST	10	90	[%RH]	[2]

Note 1: Duration = 50msec

Note 2 : Maximum Wet-Bulb should be 39°C and No condensation.

Note 3: Temperature and relative humidity range is shown below

- A. Humidity 90%RH Max ($T_a \leq 40^\circ\text{C}$)
- B. Wet-bulb temperature $\leq 39^\circ\text{C}$ ($T_a > 40^\circ\text{C}$)
- C. No condensation

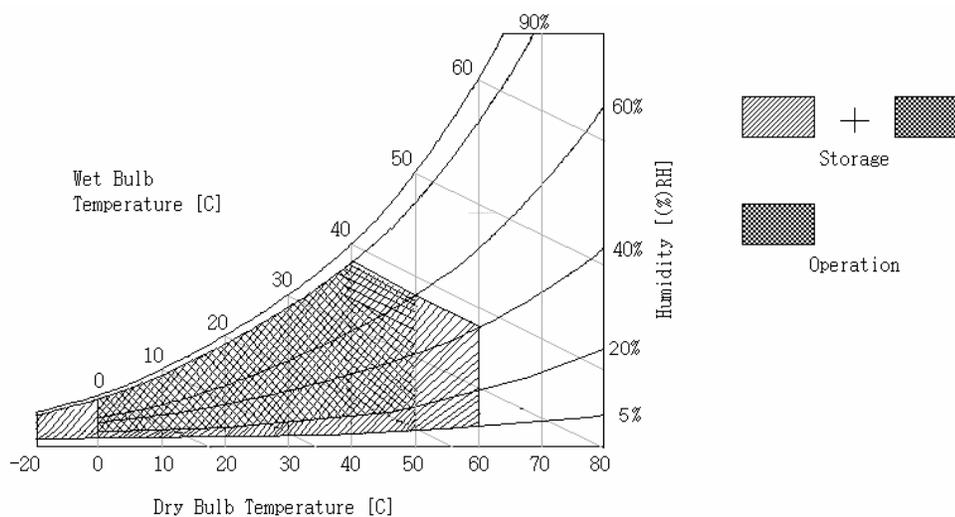

3. Block Diagram

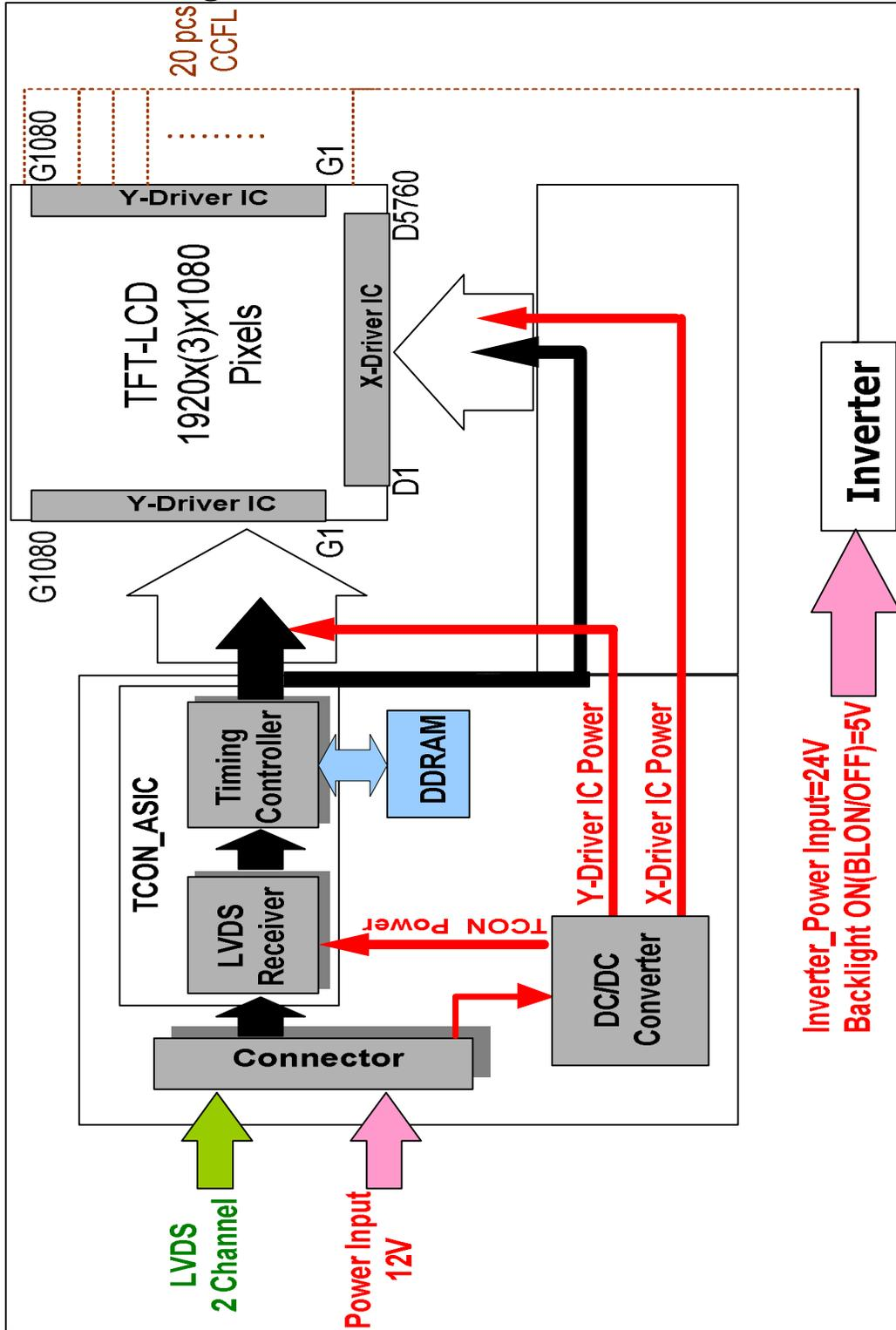

4. Electrical Characteristics

The T370HW02 V1 requires two power inputs.

- 1.1st input power: for TFT-LCD Module driving.
- 2.2nd input power: for the BLU driving, (powered inverter)

4-1 TFT-LCD Module

(Ta=25±2°C)

Parameter	Symbol	Values			Unit	Notes	
		Min	Typ	Max			
Power Supply Input Voltage	V _{CC}	10.8	12.0	13.2	V _{dc}		
Power Supply Input Current	I _{CC}		1	1.2	A	[1]	
Power Consumption	P _c	-	12	14.4	Watt	[1]	
Inrush Current	I _{RUSH}	-		4	A _{peak}	[2]	
LVDS Interface	Differential Input High Threshold Voltage	V _{TH}		100	mV	[3]	
	Differential Input Low Threshold Voltage	V _{TL}	-100		mV	[3]	
	Common Input Voltage	V _{ICM}	1.1	1.25	1.4	V	
CMOS Interface	Input High Threshold Voltage	V _{IH} (High)	2.4		3.3	V _{dc}	
	Input Low Threshold Voltage	V _{IL} (Low)	0		0.9	V _{dc}	

Note:

1. Testing condition is shown in table and figure below for electrical characteristic measurement:

	Symbol	Value	Units	Note
Input Voltage	V _{CC}	12	Volt	
Vertical Frequency	f _v	60	Hz	
Frequency of Clock	f _{CLK}	65	MHz	
Inrush Current	I _{rush}	4	A	
Time period with rush current	Δ t	470	us	Shown in Fig.1
Common input Voltage	V _{ICM}		V	
Test Pattern level	Level	L255		

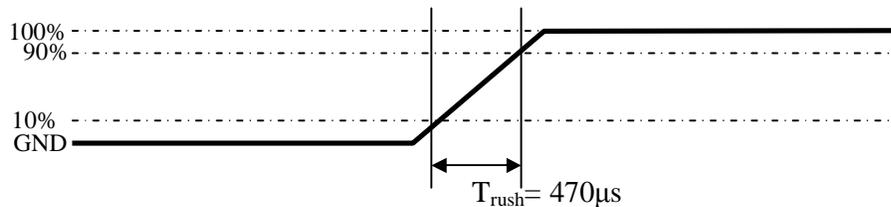

Figure 1: Measurement of I_{rush}

2. Environment condition for electrical characteristic measurement::
 Temperature and relative humidity range is shown below:
 - A. Humidity 90%RH Max (Ta ≤ 40°C)
 - B. Wet-bulb temperature ≤ 39°C.(Ta > 40°C)
 - C. No condensation

3. Measurement of LVDS differential voltage is shown in Figure 2.

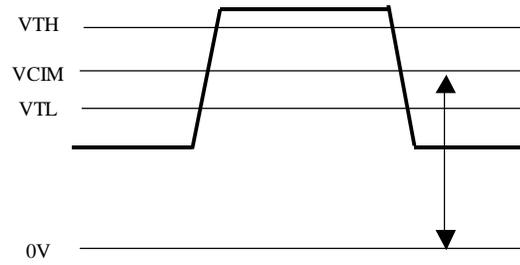

Figure 2 : LVDS Differential Voltage



4-2 BACKLIGHT UNIT

(Ta=25±2°C)

Parameter	Symbol	Value			Units	Note
		Min	Typ.	Max		
Lamp Consumption power	P _L		145	160		
Life time	L _L	50000	60000			

Note:

1. Do not attach a conducting tape to lamp connecting wire. If the lamp wire attach to conducting tape, TFT-LCD Module have a low luminance and the inverter has abnormal action because leakage current occurs between lamp wire and conducting tape.
2. The performance of the Lamp in LCM, for example lifetime or brightness, is extremely influenced by the characteristics of the DC-AC Inverter. So all the parameters of an inverter should be carefully designed so as not to produce too much leakage current from high-voltage output of the inverter. When you design or order the inverter, please make sure unwanted lighting caused by the mismatch of the lamp and the inverter (no lighting, flicker, etc) never occurs. When you confirm it, the LCD Assembly should be operated in the same condition as installed in your instrument.



4-3 INVERTER INTERFACE CHARACTERISTICS

Item	Symbol	Condition	Spec			Unit	Note	
			Min	Typical	Max			
Input Voltage	V_{DDB}		21.6	24	26.4	VDC		
Input Current	I_{DDB}	VDDB=24V	-	6.04	6.62	ADC	1	
Input Power	P_{DDB}	VDDB=24V	-	145	159	W	1	
Inrush current	I_{RUSH}	VDDB=24V	-	-	8.5	ADC	2	
Output Frequency	F_{BL}	VDDB=24V		42	-	KHz		
On/Off control voltage	V_{BLON}	ON	VDDB=24V	2	-	3.3	VDC	
		OFF		0	-	0.8		
Dimming Control Voltage	V_{DIM}	MAX	VDDB=24V	2	-	3.3	VDC	
		MIN		0	-	0.8	VDC	
Dimming Frequent	F_D	VDDB=24V	140		240	Hz		
PWM control Voltage	V_{EPWM}	MAX	VDDB=24V	-	3.3	-	VDC	
		MIN	VDDB=24V	-	0	-		
External PWM control Current	I_{EPWM}	VDDB=24V			2	mADC		
External PWM Duty ratio	D_{EPWM}	VDDB=24V	30		100	%		
External PWM Frequency	F_{EPWM}	VDDB=24V	140	180	240	Hz		

Note 1: V_{DIM} = 3.3V; EPWM = Open/High (Turn on for 45minutes)

Note 2: Duration = 20 ms;



5. INPUT TERMINAL PIN ASSIGNMENT

5-1 TFT-LCD Module

- LCD connector (CN3): JAE FI-RE51S-HF Mating connector:

No	Signal	No	Signal
1	GND	27	GND
2	Reserved.	28	RE0-
3	Reserved.	29	RE0+
4	Reserved.	30	RE1-
5	Reserved.	31	RE1+
6	Reserved.	32	RE2-
7	LVDS SEL	33	RE2+
8	Reserved.	34	GND
9	Reserved.	35	RECLKIN-
10	Reserved.	36	RECLKIN+
11	GND	37	GND
12	RO0-	38	RE3-
13	RO0+	39	RE3+
14	RO1-	40	N.C.
15	RO1+	41	N.C.
16	RO2-	42	GND
17	RO2+	43	GND
18	GND	44	GND
19	ROCLKIN-	45	GND
20	ROCLKIN+	46	GND
21	GND	47	N.C.
22	RO3-	48	VLCD(12V)
23	RO3+	49	VLCD(12V)
24	N.C.	50	VLCD(12V)
25	N.C.	51	VLCD(12V)
26	GND		

Note:

1. All GND (ground) pins should be connected together and should also be connected to the LCD's metal frame. All Vcc (power input) pins should be connected together.
2. NC Only – Pull High or Low is not allowed



5-2 INVERTER UNITS

Connector is shown below:

CN1 : S14B-PH-SM3-TB(JST)

No	Signal Name	Feature
1	V _{BL}	+24V
2	V _{BL}	+24V
3	V _{BL}	+24V
4	V _{BL}	+24V
5	V _{BL}	+24V
6	GND	GND
7	GND	GND
8	GND	GND
9	GND	GND
10	GND	GND
11	V _{dim}	Brightness control signal input (0V : Min ~ 3.3 V :Max)
12	BL On/Off	3.3V : On, 0V : Off
13	E-PWM Dim	External PWM Dimming Control
14	SEL pin	High(2~5V) : internal PWM (pin 11) Low(0~0.8) : external PWM (pin13)

CN2 : S10B-PH-SM3-TB(JST)

No	Signal Name	Feature
1	V _{BL}	+24V
2	V _{BL}	+24V
3	V _{BL}	+24V
4	V _{BL}	+24V
5	V _{BL}	+24V
6	GND	GND
7	GND	GND
8	GND	GND
9	GND	GND
10	GND	GND



5-3 LVDS DATA FORMAT

LVDS Option = L (GND) or OPEN = NS

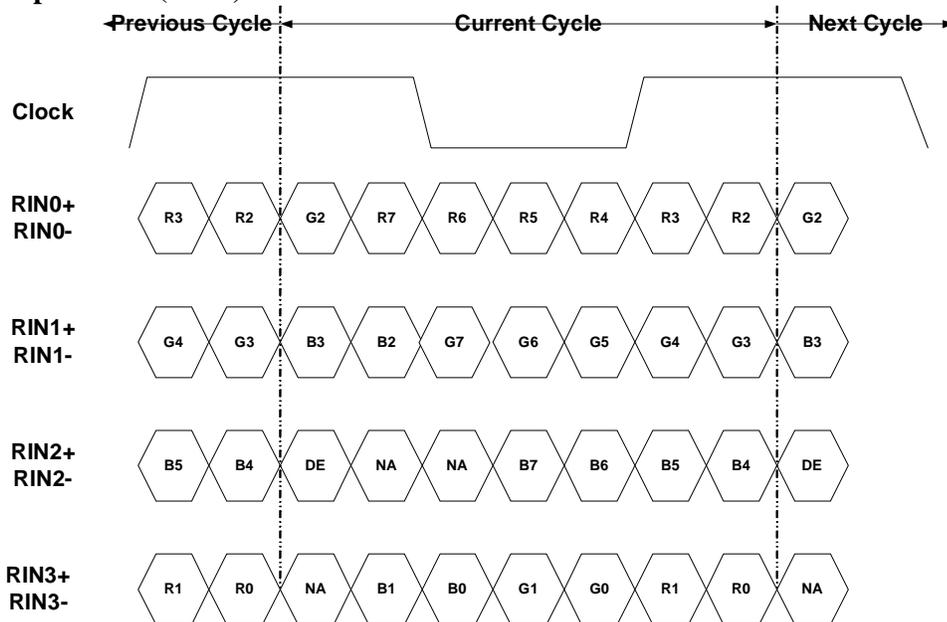

LVDS Option = H (3.3V) è JETDA

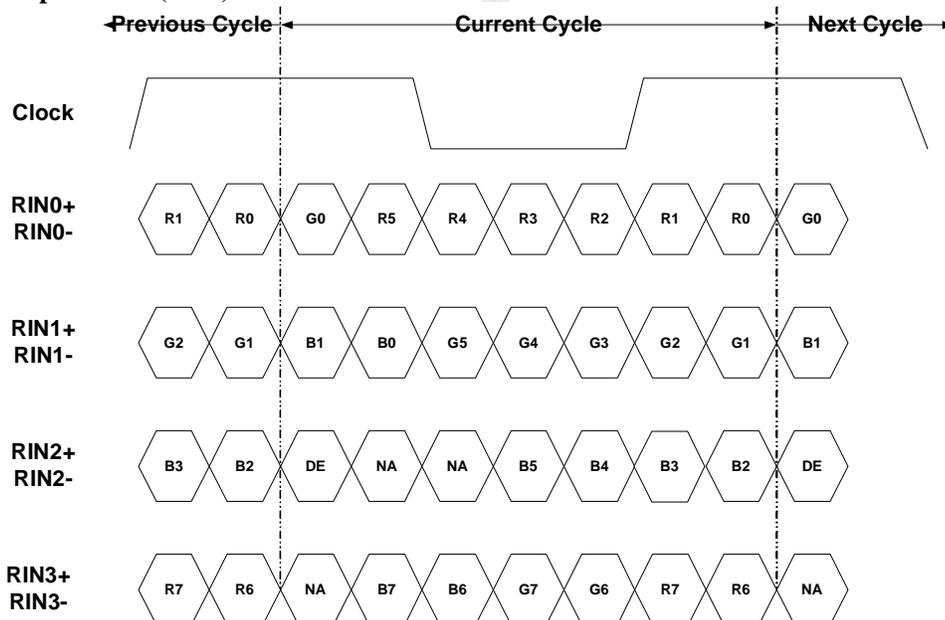



5-4 COLOR INPUT DATA ASSIGNMENT

The brightness of each primary color (red, green and blue) is based on the 8 bit gray scale data input for the color; the higher the binary input, the brighter the color. The table below provides a reference for color versus data input.

COLOR DATA REFERENCE

Color		Input Color Data																							
		RED								GREEN								BLUE							
		MSB				LSB				MSB				LSB				MSB				LSB			
		R7	R6	R5	R4	R3	R2	R1	R0	G7	G6	G5	G4	G3	G2	G1	G0	B7	B6	B5	B4	B3	B2	B1	B0
Basic Color	Black	0	0	0	0	0	0	0	0	0	0	0	0	0	0	0	0	0	0	0	0	0	0	0	0
	Red(255)	1	1	1	1	1	1	1	1	0	0	0	0	0	0	0	0	0	0	0	0	0	0	0	0
	Green(255)	0	0	0	0	0	0	0	0	1	1	1	1	1	1	1	1	0	0	0	0	0	0	0	0
	Blue(255)	0	0	0	0	0	0	0	0	0	0	0	0	0	0	0	0	1	1	1	1	1	1	1	1
	Cyan	0	0	0	0	0	0	0	0	1	1	1	1	1	1	1	1	1	1	1	1	1	1	1	1
	Magenta	1	1	1	1	1	1	1	1	0	0	0	0	0	0	0	0	1	1	1	1	1	1	1	1
	Yellow	1	1	1	1	1	1	1	1	1	1	1	1	1	1	1	1	0	0	0	0	0	0	0	0
	White	1	1	1	1	1	1	1	1	1	1	1	1	1	1	1	1	1	1	1	1	1	1	1	1
RED	RED(000)	0	0	0	0	0	0	0	0	0	0	0	0	0	0	0	0	0	0	0	0	0	0	0	0
	RED(001)	0	0	0	0	0	0	0	1	0	0	0	0	0	0	0	0	0	0	0	0	0	0	0	0

	RED(254)	1	1	1	1	1	1	1	0	0	0	0	0	0	0	0	0	0	0	0	0	0	0	0	0
	RED(255)	1	1	1	1	1	1	1	1	0	0	0	0	0	0	0	0	0	0	0	0	0	0	0	0
GREEN	GREEN(000)	0	0	0	0	0	0	0	0	0	0	0	0	0	0	0	0	0	0	0	0	0	0	0	0
	GREEN(001)	0	0	0	0	0	0	0	0	0	0	0	0	0	0	1	0	0	0	0	0	0	0	0	0

	GREEN(254)	0	0	0	0	0	0	0	0	1	1	1	1	1	1	1	0	0	0	0	0	0	0	0	0
GREEN(255)	0	0	0	0	0	0	0	0	1	1	1	1	1	1	1	1	0	0	0	0	0	0	0	0	
BLUE	BLUE(000)	0	0	0	0	0	0	0	0	0	0	0	0	0	0	0	0	0	0	0	0	0	0	0	0
	BLUE(001)	0	0	0	0	0	0	0	0	0	0	0	0	0	0	0	0	0	0	0	0	0	0	0	1

	BLUE(254)	0	0	0	0	0	0	0	0	0	0	0	0	0	0	0	0	1	1	1	1	1	1	1	0
BLUE(255)	0	0	0	0	0	0	0	0	0	0	0	0	0	0	0	0	1	1	1	1	1	1	1	1	



6. Interface Timing

6-1 INPUT SIGNAL TIMING SPECIFICATIONS:

This is the signal timing required at the input of the User connector. All of the interface signal timing should be satisfied with the following specifications for its proper operation.

Timing Table (DE only Mode)

A. Frame Rate = 60 Hz

Signal	Item	Symbol	Min	Type	Max	Unit
Vertical Section	Period	Tv	1090	1130	1200	Th
	Active	Tdisp (v)	1080			Th
	Blanking	Tblk (v)	10	50	120	Th
Horizontal Section	Period	Th	1030	1100	1180	Tclk
	Active	Tdisp (h)	960			Tclk
	Blanking	Tblk (h)	70	140	220	Tclk
Clock	Frequency	1/Tclk	67.362	74.58	84.96	MHz
Vertical Frequency	Frequency	Freq	60	60	60	Hz
Horizontal Frequency	Frequency	Freq	65.4	67.8	72	KHz

B. Frame Rate = 50 Hz

Signal	Item	Symbol	Min	Type	Max	Unit
Vertical Section	Period	Tv	1316	1356	1426	Th
	Active	Tdisp (v)	1080			Th
	Blanking	Tblk (v)	236	276	346	Th
Horizontal Section	Period	Th	1030	1100	1180	Tclk
	Active	Tdisp (h)	960			Tclk
	Blanking	Tblk (h)	70	140	220	Tclk
Clock	Frequency	1/Tclk	67.774	74.58	84.134	MHz
Vertical Frequency	Frequency	Freq	50	50	50	Hz
Horizontal Frequency	Frequency	Freq	65.8	67.8	71.3	KHz

1.) Display position is specific by the rise of DE signal only.

Horizontal display position is specified by the falling edge of 1st DCLK right after the rise of ENAB, is displayed on the left edge of the screen.

Vertical display position is specified by the rise of DE after a “Low” level period equivalent to eight times of horizontal period. The 1st data corresponding to one horizontal line after the rise the of ENAB is displayed at the top line of screen.

3.) If a period of DEB “High” is less than 1920 DCLK or less than 1080 lines, the rest of the screen displays black.

4.) The display position does not fit to the screen if a period of DE “High” and the effective data period do not synchronize with each other.



Signal Timing Waveforms

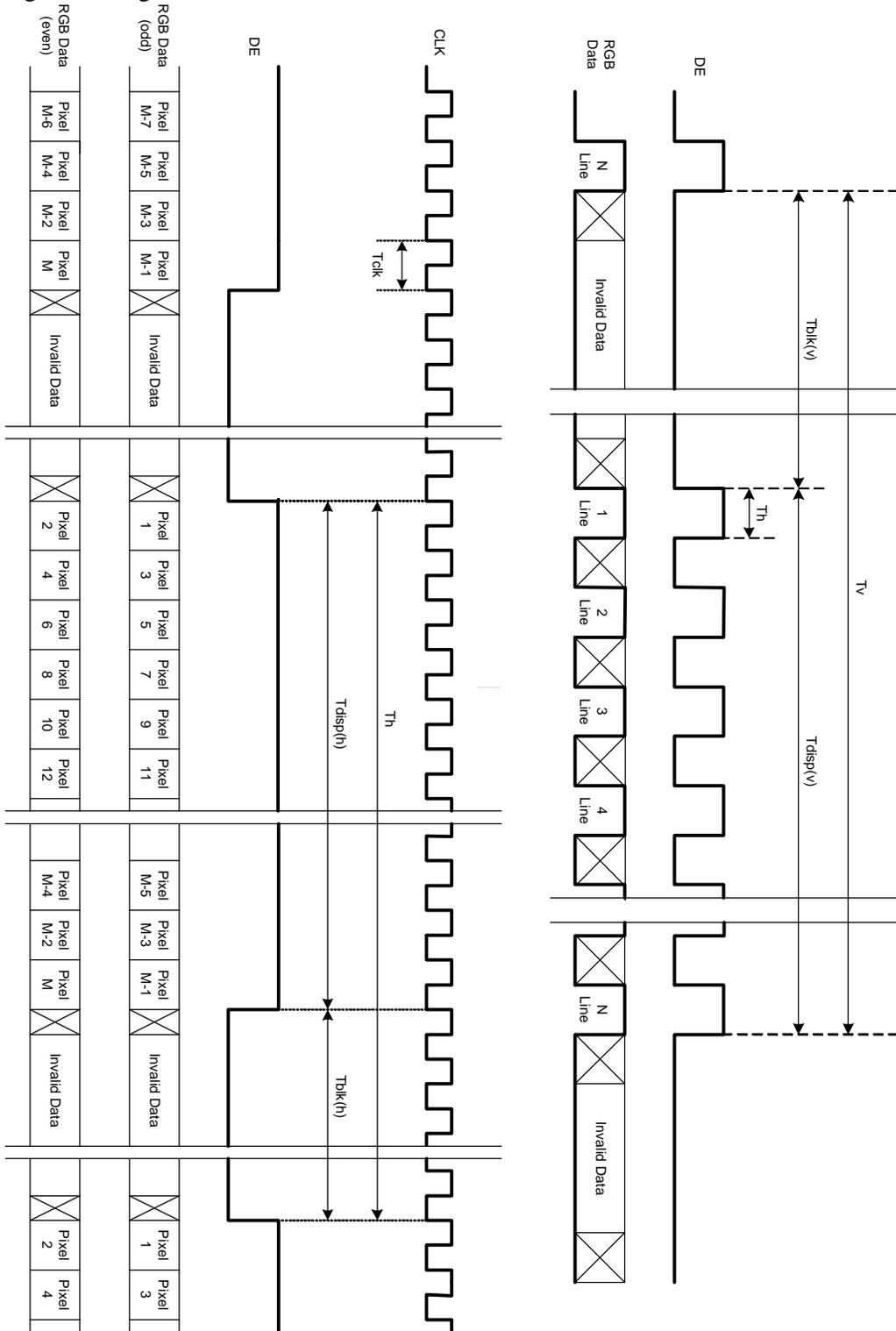



6-2 Power Sequence of LCD Module (ON/OFF)

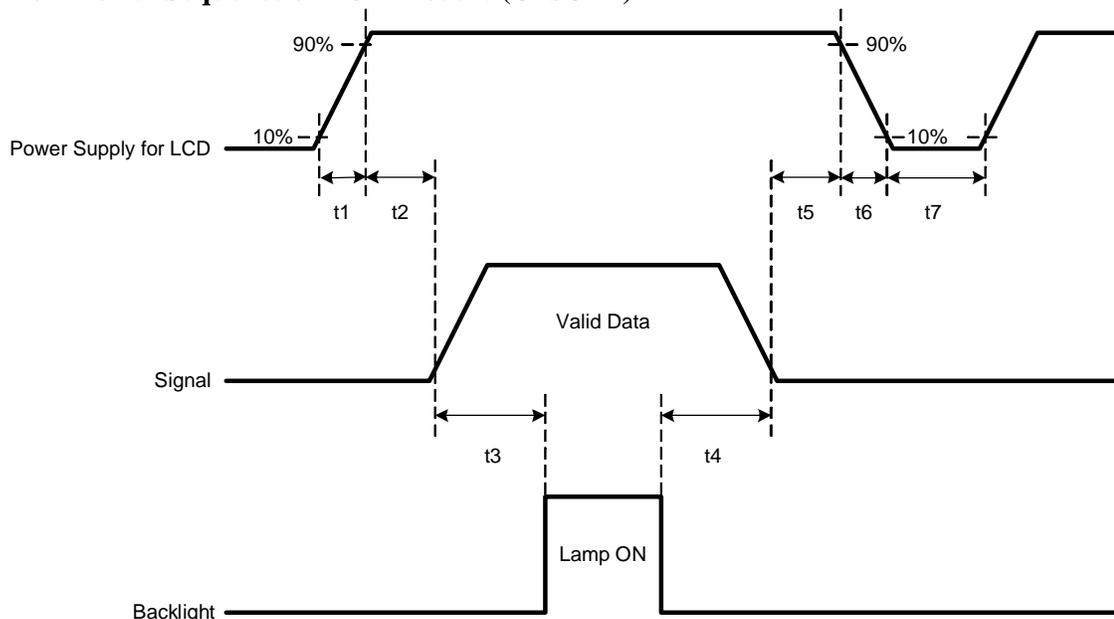

Parameter	Values			Units Min.
	Min.	Typ.	Max.	
T1	470	-	5000	us
T2	20	-	35	ms
T3	500	-	-	ms
T4	200	-	-	ms
T5	5	-	-	ms
T6	-	-	30	ms
T7	1	-	-	s

Note: User should follow the power on/off sequence and the rising/falling time to avoid miss operation of the panel.

6-3 Power Sequence of Inverter

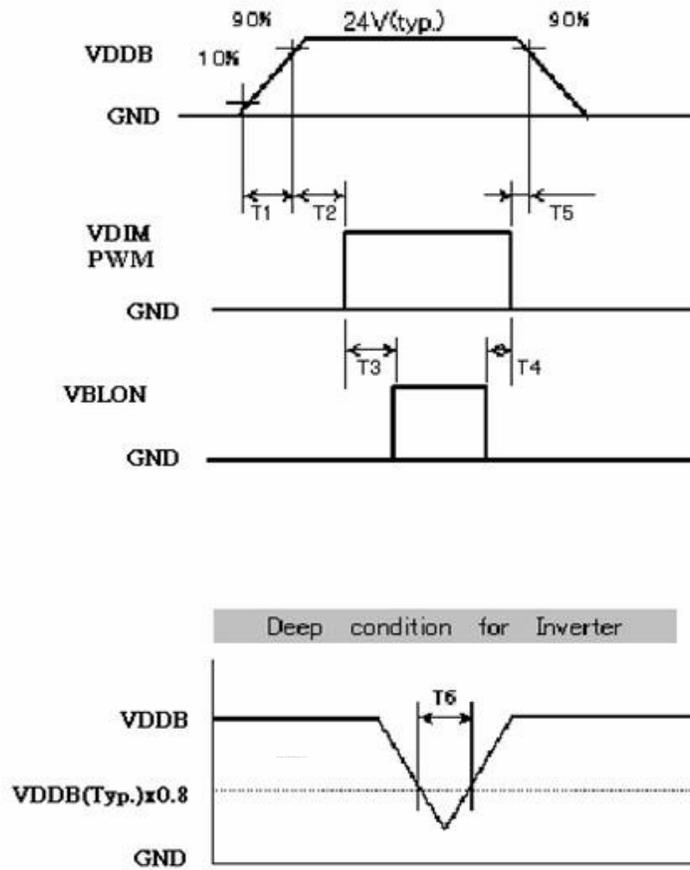

Parameter	Values			Units
	Min.	Typ.	Max.	
T1	20	-	-	ms
T2	500	-	-	ms
T3	250	-	-	ms
T4	0	-	-	ms
T5	1	-	-	ms
T6	-	-	10	ms

7. Optical Specification

7-1 Warm-up procedure & testing methods & testing condition

Warm-up procedure: Stable for 45 minutes in dark environment at 25°C.

Measurement tools: BM7 or equivalent

Testing method: Specified distance is 50cm from LCD surface at a viewing angle of φ and θ is 0°.
(Measurement Equipment is shown in Fig.1)

Testing Condition:

Parameter	Value	Parameter	Value
VDDB	24V	Frequency (f _v)	60Hz
IDDB	5A	Temperature	Ta=25±2°C

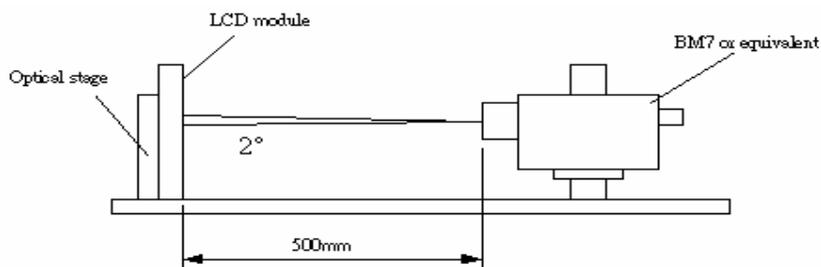

FIG.1 Measurement equipment

7-2 Optical Specification

(Ta=25±2°C)

Parameter	Symbol	Condition	Value			Units	Notes	
			Min.	Typ.	Max.			
Contrast Ratio	CR	$\varphi=0^\circ, \theta=0^\circ$ Viewing Normal angle	1200	1500			1	
Surface Luminance, white	LWH		400	500		cd/m ²	2	
Luminance Variation	$\hat{\delta}_{\text{WHITE}}$ 9 pts				1.3	cd/m ²	3	
Response Time	Rise Time		Tr _R		(8)		ms	4
	Decay Time	Tr _D		(15)		ms		
	Gray to Gray	T _γ		(6)		ms		
Color Coordinates (CIE 1931)	RED	R _X	Typ -0.03	0.640	Typ +0.03			
		R _Y		0.330				
	GREEN	G _X		0.29				
		G _Y		0.600				
	BLUE	B _X		0.150				
		B _Y		0.060				
	WHITE	W _X		0.280				
W _Y		0.290						
Viewing Angle	x axis, right	θ_r ($\varphi=0^\circ$)	CR≥20	88			Degree	5
	x axis, left	θ_l ($\varphi=180^\circ$)		88				
	y axis, up	θ_u ($\varphi=90^\circ$)		88				
	y axis, down	θ_d ($\varphi=0^\circ$)		88				

Note:

1. Contrast ratio will be measured in the center of panel (point 5 in Figure 2), Contrast Ratio (CR) is defined mathematically as:

$$C/R(\text{Contrast ratio}) = \frac{\text{Lum}(L255)}{\text{Lum}(L0)}$$

Lum(L255):Luminance measured at the center point of panel when all pixels is white.

Lum(L0) : Luminance measured at the center point of panel when all pixels is black.

2. Surface luminance is defined as luminance value measured at point 5 with pre-described measurement methods and measurement condition.

3. Luminance variation, δ WHITE, is defined as:

$$\delta_{\text{WHITE (9P)}} = \frac{\text{Maximum}(L_{\text{on}1}, L_{\text{on}2}, \dots, L_{\text{on}9})}{\text{Minimum}(L_{\text{on}1}, L_{\text{on}2}, \dots, L_{\text{on}9})}$$

Position of each 9 pts for measuring is shown in FIG 2.

4. Response time is the time required for the display to transition from black to white (Rise Time, T_{rR}) and from white to black (Decay Time, T_{rD}), that is shown in FIG3.

5. Detailed measurement method of viewing angle is shown in Fig4.

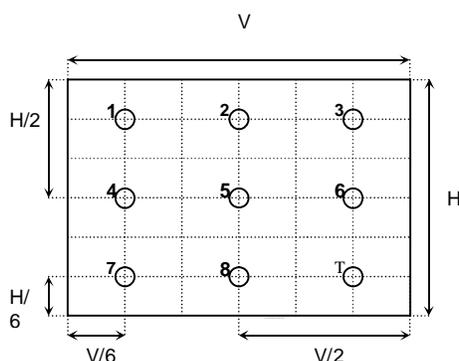
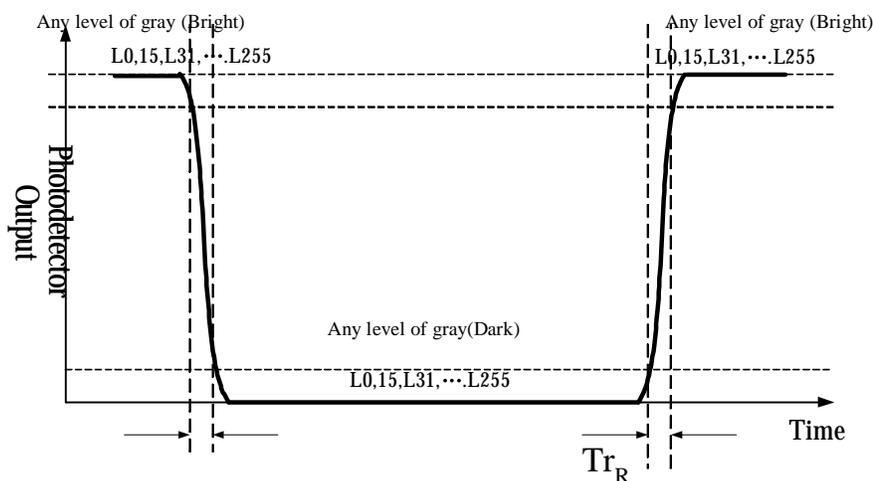

FIG. 2 Luminance measurement positions



Note: The response time is defined as the following figure and shall be measured by switching the input signal for “any level of gray(bright) “ and “any level of gray(dark)”

FIG.3 Measurement of Response Time

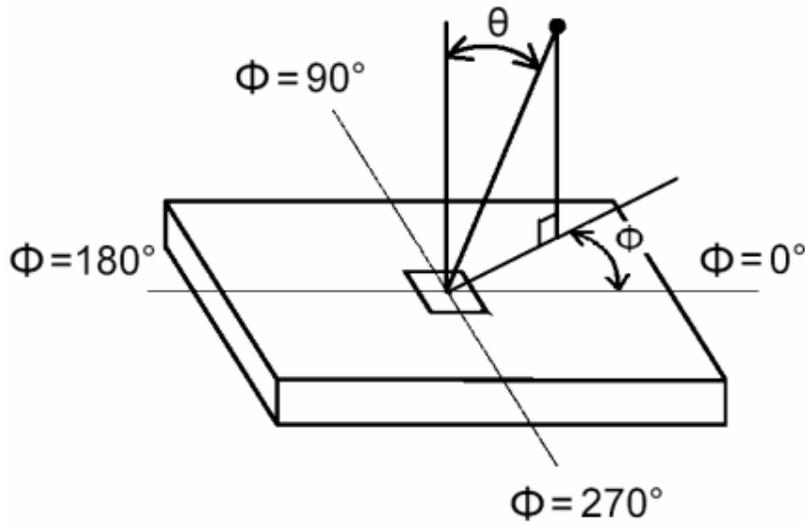

FIG.4 Measurement of viewing angle



8. Mechanical Characteristics

The contents provide general mechanical characteristics for the model T370HW02 V1. Detailed mechanical drawings are shown in the following pages.

Outline Dimension	Horizontal	877.0 mm
	Vertical	514.6mm
	Depth	54.7 mm(with inverter)
Bezel Opening	Horizontal	827.8 mm
	Vertical	469.4 mm
Active Display Area	Horizontal	819.36 mm
	Vertical	460.89 mm
Weight	11000g (Typ.)	



Mechanical Figure:

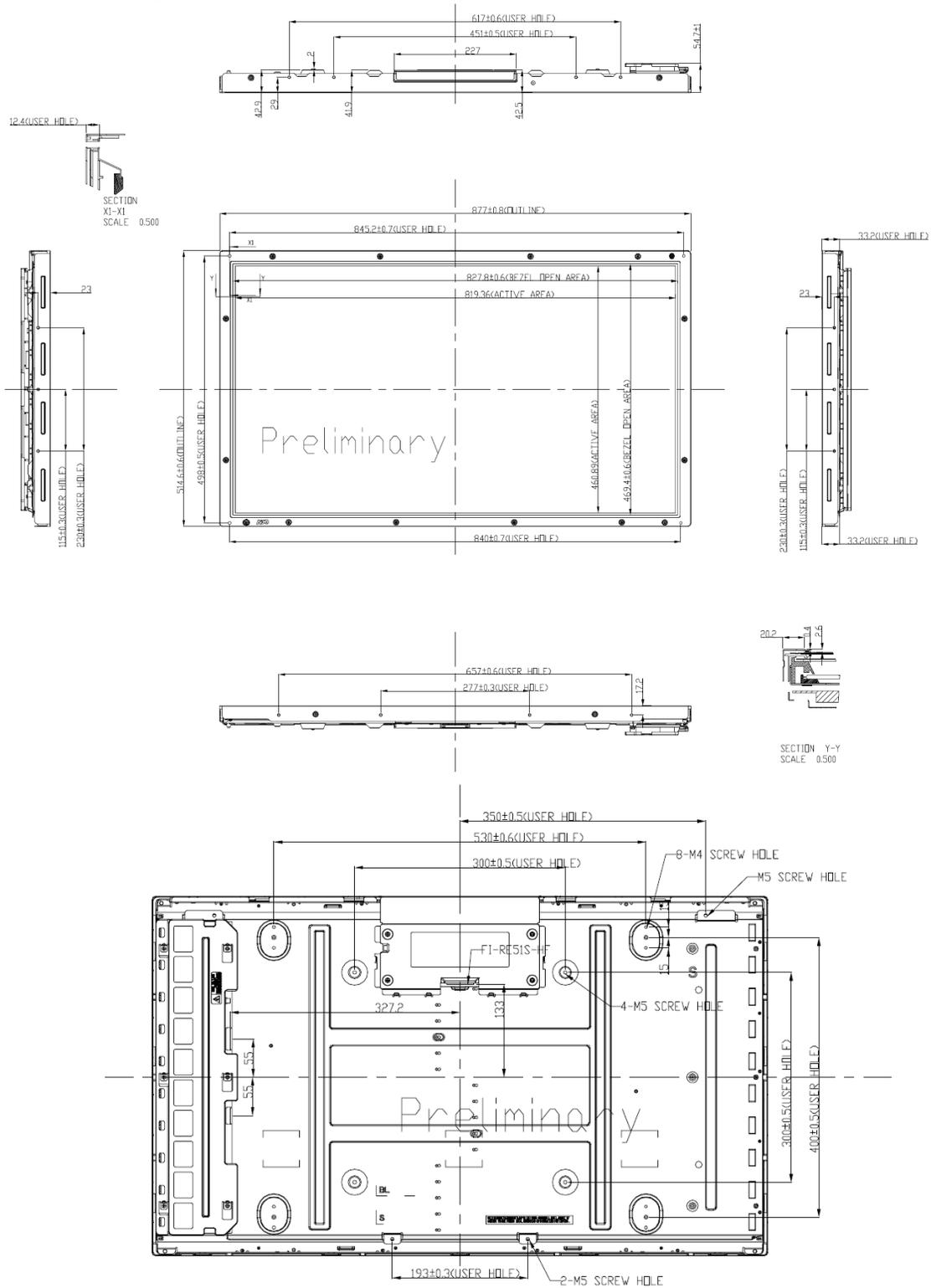

©Copyright AU Optronics, Inc.
Sep, 2006 All Rights Reserved.
No Reproduction and Redistribution Allowed

T370HW02 V1

24/31



9. Reliability

Environment test condition:

No	Test Item	Condition
1	High temperature storage test	Ta=60°C 240h
2	Low temperature storage test	Ta= -20°C 240h
3	High temperature operation test	Ta=50°C 80%RH 240h
4	Low temperature operation test	Ta=0°C 240h
5	Vibration test (non-operating)	Wave form: random Vibration level: 1.5G RMS Bandwidth: 10-500Hz, Duration: X, Y, Z 20min One time each direction
6	Shock test (non-operating)	Shock level: 50G Waveform: half sine wave, 11ms Direction: ±X, ±Y, ±Z One time each direction
7	Vibration test (with carton)	Wave form: random Vibration level: 1.5G RMS Bandwidth: 10-500Hz, Duration: X, Y, Z 30min One time each direction
8	Drop test (with carton)	Height: 31cm 1 corner, 3 edges, 6 surfaces (ASTMD4169-I)



10. International Standard

10-1 Safety

- (1) UL1950 Third Edition, Underwriters Laboratories, Inc. Jan. 28, 1995
Standard for Safety of Information Technology Equipment Including electrical Business Equipment.
- (2) CAN/CSA C22.2 No. 950-95/60950 Third Edition, Canadian Standards Association,
Standard for Safety of Information Technology Equipment Including Electrical Business Equipment.
- (3) EN60950: 1992+A2: 1993+A2: 1993+C3: 1995+A4: 1997+A11: 1997
IEC 950: 1991+A1: 1992+A2: 1993+C3: 1995+A4:1996
European Committee for Electrotechnical Standardization (CENELEC)
EUROPEAN STANDARD for Safety of Information Technology Equipment Including Electrical Business Equipment.

10-2 EMC

- a) ANSI C63.4 “Methods of Measurement of Radio-Noise Emissions from Low-Voltage Electrical and Electrical Equipment in the Range of 9kHz to 40GHz. “American National standards Institute(ANSI), 1992
- b) C.I.S.P.R “Limits and Methods of Measurement of Radio Interface Characteristics of Information Technology Equipment.” International Special committee on Radio Interference.
- c) EN 55022 “Limits and Methods of Measurement of Radio Interface Characteristics of Information Technology Equipment.” European Committee for Electrotechnical Standardization. (CENELEC), 1998



11. Packing

11-1 DEFINITION OF LABEL:

A. Panel Label:

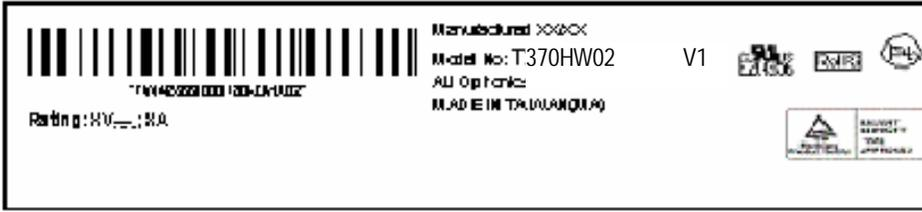

Green mark description

For Pb Free Product, AUO will add for identification.

For RoHs compatible products, AUO will add for identification.

Note: The green Mark will be present only when the green documents have been ready by AUO internal green team. (The definition of green design follows the AUO green design checklist.)

B. Carton Label:

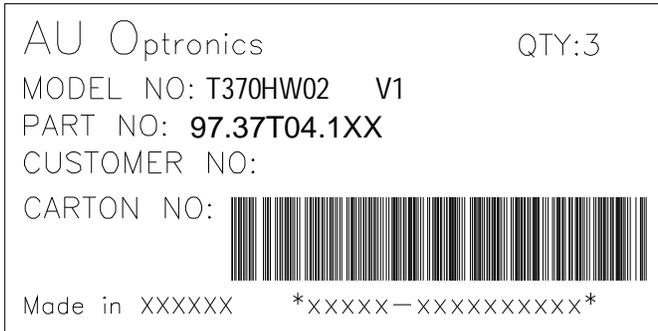



11-2 PACKING METHODS:

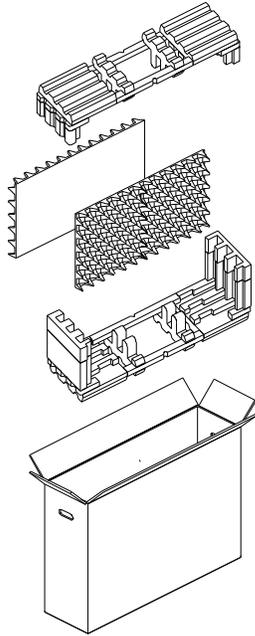

Packing Specification:

	Item	Specification			Packing Remark
		Qty.	Dimension	Weight (kg)	
1	Packing BOX	3 pcs/box	985(L)mm*280(W)mm*692(H)mm	34	
2	Pallet	1	1130(L)mm*980(W)mm*123(H)mm	10	
3	Boxes per Pallet	8 boxes/Pallet (By Air) ; 12 Boxes/Pallet (By Sea)			
4	Panels per Pallet	24pcs/pallet(By Air) ; 36 Boxes/Pallet (By Sea)			
	Pallet after packing	24 (by Air) 36(by Sea)	1130(L)mm*980(W)mm*150.4(H)mm (by Air) 1130(L)mm*980(W)mm*219.6(H)m (by Sea)	282 (by Air) 418 (by Sea)	



12. PRECAUTIONS

Please pay attention to the followings when you use this TFT LCD module.

12-1 MOUNTING PRECAUTIONS

- (1) You must mount a module using mounting holes arranged in four corners or four sides.
- (2) You should consider the mounting structure so that uneven force (ex. Twisted stress) is not applied to module. And the case on which a module is mounted should have sufficient strength so that external force is not transmitted directly to the module.
- (3) Please attach the surface transparent protective plate to the surface in order to protect the polarizer. Transparent protective plate should have sufficient strength in order to resist external force.
 - (4) You should adopt radiation structure to satisfy the temperature specification.
 - (5) Acetic acid type and chlorine type materials for the cover case are not desirable because the former generates corrosive gas of attacking the polarizer at high temperature and the latter causes circuit break by electro-chemical reaction.
 - (6) Do not touch, push or rub the exposed polarizer with glass, tweezers or anything harder than HB pencil lead. And please do not rub with dust clothes with chemical treatment. Do not touch the surface of polarizer for bare hand or greasy cloth. (Some cosmetics are detrimental to the polarizer.)
 - (7) When the surface becomes dusty, please wipe gently with absorbent cotton or other soft materials like chamois soaks with petroleum benzene. Normal-hexane is recommended for cleaning the adhesives used to attach front/ rear polarizer. Do not use acetone, toluene and alcohol because they cause chemical damage to the polarizer.
 - (8) Wipe off saliva or water drops as soon as possible. Their long time contact with polarizer causes deformations and color fading.
 - (9) Do not open the case because inside circuits do not have sufficient strength.

12-2 OPERATING PRECAUTIONS

- (1) The spike noise causes the mis-operation of circuits. It should be lower than following voltage: $V = \pm 200\text{mV}$ (Over and under shoot voltage)
- (2) Response time depends on the temperature. (In lower temperature, it becomes longer.)
- (3) Brightness of CCFL depends on the temperature. (In lower temperature, it becomes lower.) And in lower temperature, response time (required time that brightness is stable after turned on) becomes longer.
- (4) Be careful for condensation at sudden temperature change. Condensation makes damage to polarizer or electrical contacted parts. And after fading condensation, smear or spot will occur.
- (5) When fixed patterns are displayed for a long time, remnant image is likely to occur.
- (6) Module has high frequency circuits. Sufficient suppression to the electromagnetic interference shall be done by system manufacturers. Grounding and shielding methods may be important to minimize the interface.



12-3 ELECTROSTATIC DISCHARGE CONTROL

Since a module is composed of electronic circuits, it is not strong to electrostatic discharge. Make certain that treatment persons are connected to ground through wristband etc. And don't touch interface pin directly.

12-4 PRECAUTIONS FOR STRONG LIGHT EXPOSURE

Strong light exposure causes degradation of polarizer and color filter.

12-5 STORAGE

When storing modules as spares for a long time, the following precautions are necessary.

- (1) Store them in a dark place. Do not expose the module to sunlight or fluorescent light. Keep the temperature between 5°C and 35°C at normal humidity.
- (2) The polarizer surface should not come in contact with any other object. It is recommended that they be stored in the container in which they were shipped.

12-6 HANDLING PRECAUTIONS FOR PROTECTION FILM

- (1) The protection film is attached to the bezel with a small masking tape. When the protection film is peeled off, static electricity is generated between the film and polarizer. This should be peeled off slowly and carefully by people who are electrically grounded and with well ion-blown equipment or in such a condition, etc.
- (2) When the module with protection film attached is stored for a long time, sometimes there remains a very small amount of flue still on the Bezel after the protection film is peeled off.
- (3) You can remove the glue easily. When the glue remains on the Bezel or its vestige is recognized, please wipe them off with absorbent cotton waste or other soft material like chamois soaked with normal-hexane.