

Model Name: T370HW04 V4

Issue Date: 2010/3/5

() Preliminary Specifications

(*) Final Specifications

Customer Signature	Date	AUO	Date
Approved By		Approval By PM Director Frank Hsu	<i>Frank Hsu.</i>
Note		Reviewed By RD Director Eugene CC Chen	<i>Eugene Chen 2010 3/11</i>
		Reviewed By Project Leader Sarah Ke	<i>Sarah Ke</i>
		Prepared By PM ChihYang Wang	<i>ChihYang Wang</i>

Contents

No		
		CONTENTS
		RECORD OF REVISIONS
1		GENERAL DESCRIPTION
2		ABSOLUTE MAXIMUM RATINGS
3		ELECTRICAL SPECIFICATION
	3-1	ELECTRICAL CHARACTERISTICS
	3-2	INTERFACE CONNECTIONS
	3-3	SIGNAL TIMING SPECIFICATION
	3-4	SIGNAL TIMING WAVEFORM
	3-5	COLOR INPUT DATA REFERENCE
	3-6	POWER SEQUENCE
	3-7	BACKLIGHT SPECIFICATION
4		OPTICAL SPECIFICATION
5		MECHANICAL CHARACTERISTICS
6		RELIABILITY TEST ITEMS
7		INTERNATIONAL STANDARD
	7-1	SAFETY
	7-2	EMC
8		PACKING
	8-1	DEFINITION OF LABEL
	8-2	PACKING METHODS
	8-3	PALLET AND SHIPMENT INFORMATION
9		PRECAUTION
	9-1	MOUNTING PRECAUTIONS
	9-2	OPERATING PRECAUTIONS
	9-3	ELECTROSTATIC DISCHARGE CONTROL
	9-4	PRECAUTIONS FOR STRONG LIGHT EXPOSURE
	9-5	STORAGE
	9-6	HANDLING PRECAUTIONS FOR PROTECT FILM



Record of Revision

Version	Date	Page	Description
0.0	2010/03/5		Final Spec First Release

1. General Description

This specification applies to the 37.0 inch Color TFT-LCD Module T370HW04 V4. This LCD module has a TFT active matrix type liquid crystal panel 1,920x1,080 pixels, and diagonal size of 37.0 inch. This module supports 1,920 x1,080 mode. Each pixel is divided into Red, Green and Blue sub-pixels or dots which are arranged in vertical stripes. Gray scale or the brightness of the sub-pixel color is determined with a 8-bit gray scale signal for each dot.

The T370HW04 V4 has been designed to apply the 8-bit 2 channel LVDS interface method. It is intended to support displays where high brightness, wide viewing angle, high color saturation, and high color depth are very important.

* General Information

Items	Specification	Unit	Note
Active Screen Size	37.00	inch	
Display Area	819.36(H) x 460.89(V)	mm	
Outline Dimension	862.4(H) x 504 (V) x 22.4 (D)	mm	D : Front bezel to T-CON cover
Driver Element	a-Si TFT active matrix		
Display Colors	8 bits, 16.7M	Colors	
Number of Pixels	1,920x1080	Pixel	
Pixel Pitch	0.4268 (H) x 0.4268 (W)	mm	
Pixel Arrangement	RGB vertical stripe		
Display Operation Mode	Normally Black		
Surface Treatment	Anti-Glare, 3H		Haze=11%

2. Absolute Maximum Ratings

The followings are maximum values which, if exceeded, may cause faulty operation or damage to the unit

Item	Symbol	Min	Max	Unit	Conditions
Logic/LCD Drive Voltage	Vcc	-0.3	14	[Volt]	Note 1
Input Voltage of Signal	Vin	-0.3	4	[Volt]	Note 1
Operating Temperature	TOP	0	+50	[°C]	Note 2
Operating Humidity	HOP	10	90	[%RH]	Note 2
Storage Temperature	TST	-20	+60	[°C]	Note 2
Storage Humidity	HST	10	90	[%RH]	Note 2
Panel Surface Temperature	PST		65	[°C]	Note 3

Note 1: Duration: 50 msec.

Note 2: Maximum Wet-Bulb should be 39°C and No condensation.

The relative humidity must not exceed 90% non-condensing at 40°C or less. At temperature greater than 40°C, the wet bulb temperature must not exceed 39°C.

Note 3: Surface temperature is measured at 50°C Dry condition

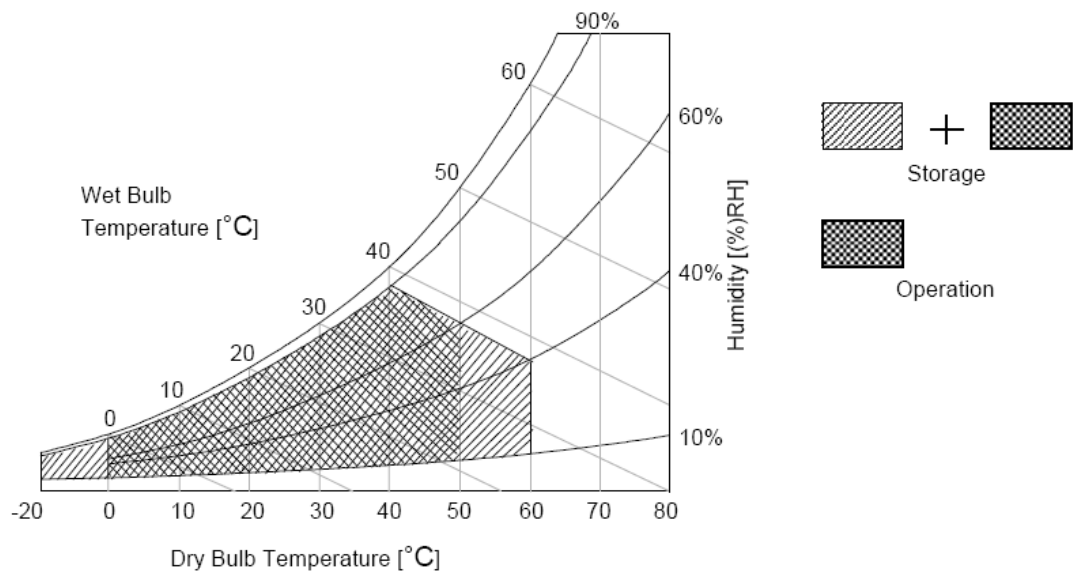

3. Electrical Specification

The T370HW04 V4 requires two power inputs. One is employed to power the LCD electronics and to drive the TFT array and liquid crystal. The second is employed for LED lightbar.

3.1 Electrical Characteristics

Parameter		Symbol	Value			Unit	Note
			Min.	Typ.	Max		
LCD							
Power Supply Input Voltage		V_{DD}	10.8	12	13.2	V_{DC}	1
Power Supply Input Current		I_{DD}	-	0.77	0.85	A	2
Power Consumption		P_C		9.24	10.2	Watt	2
Inrush Current		I_{RUSH}			4	A	3
LVDS Interface	Differential Input High Threshold Voltage	V_{TH}	--	--	+100	mV_{DC}	4
	Differential Input Low Threshold Voltage	V_{TL}	-100	--	--	mV_{DC}	4
	Input Common Mode Voltage	V_{ICM}	1.1	1.25	1.4	V_{DC}	4
CMOS Interface	Input High Threshold Voltage	V_{IH} (HIGH)	2.7	--	3.3	V_{DC}	
	Input Low Threshold Voltage	V_{IL} (LOW)	0	--	0.6	V_{DC}	
Backlight Power Consumption		P_{BL}	--	84.5	89.4	Watt	
Life Time (MTTF)			30000		--	Hours	7

Note:

1. The ripple voltage should be controlled under 10% of V_{CC}
2. Test Condition:
 - (1) $V_{DD} = 12.0V$
 - (2) $F_v = 60Hz$
 - (3) $F_{CLK} = 82MHz$
 - (4) Temperature = 25 °C
 - (5) Test Pattern : White Pattern

3. Measurement condition : Rising time = 400us

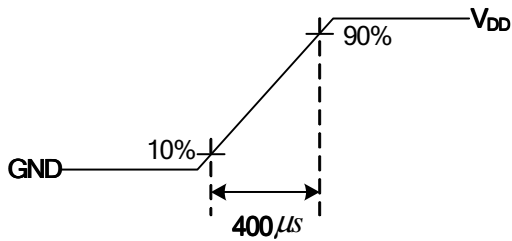

4. $V_{ICM} = 1.25V$

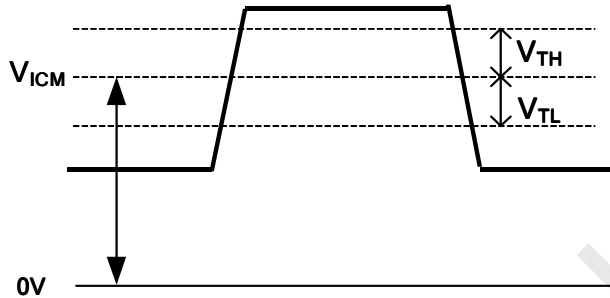

5. Do not attach a conducting tape to lamp connecting wire. If the lamp wire attach to conducting tape, TFT-LCD Module have a low luminance and the inverter has abnormal action because leakage current occurs between lamp wire and conducting tape.
6. The relative humidity must not exceed 80% non-condensing at temperature of 40°C or less. At temperature greater than 40°C, the wet bulb temperature must not exceed 39°C. When operating at high temperature, the brightness of LED will drop and the life time of LED will be reduced.
7. The lifetime (MTTF) is defined as the time where luminance of LED is 50% compared to its original value. [Operating condition: Continuous operating at $T_a = 25 \pm 2^\circ C$]

3.2 Interface Connections

- LCD connector: 187059-51221 (P-TWO, LVDS connector)
- Mating connector:

PIN	Symbol	Description	PIN	Symbol	Description
1	GND	Ground	26	GND	Ground
2	NC	No connection	27	GND	Ground
3	Reserved	AUO Internal Use Only	28	CH2_0-	LVDS Channel 2, Signal 0-
4	Reserved	AUO Internal Use Only	29	CH2_0+	LVDS Channel 2, Signal 0+
5	NC	No connection	30	CH2_1-	LVDS Channel 2, Signal 1-
6	Reserved	AUO Internal Use Only	31	CH2_1+	LVDS Channel 2, Signal 1+
7	LVDS_SEL	Open/High(3.3V) for NS, Low(GND) for JEIDA	32	CH2_2-	LVDS Channel 2, Signal 2-
8	Reserved	AUO Internal Use Only	33	CH2_2+	LVDS Channel 2, Signal 2+
9	Reserved	AUO Internal Use Only	34	GND	Ground
10	Reserved	AUO Internal Use Only	35	CH2_CLK-	LVDS Channel 2, Clock -
11	GND	Ground	36	CH2_CLK+	LVDS Channel 2, Clock +
12	CH1_0-	LVDS Channel 1, Signal 0-	37	GND	Ground
13	CH1_0+	LVDS Channel 1, Signal 0+	38	CH2_3-	LVDS Channel 2, Signal 3-
14	CH1_1-	LVDS Channel 1, Signal 1-	39	CH2_3+	LVDS Channel 2, Signal 3+
15	CH1_1+	LVDS Channel 1, Signal 1+	40	Reserved	AUO Internal Use Only
16	CH1_2-	LVDS Channel 1, Signal 2-	41	Reserved	AUO Internal Use Only
17	CH1_2+	LVDS Channel 1, Signal 2+	42	GND	Ground
18	GND	Ground	43	GND	Ground
19	CH1_CLK-	LVDS Channel 1, Clock -	44	GND	Ground
20	CH1_CLK+	LVDS Channel 1, Clock +	45	GND	Ground
21	GND	Ground	46	GND	Ground
22	CH1_3-	LVDS Channel 1, Signal 3-	47	NC	No connection
23	CH1_3+	LVDS Channel 1, Signal 3+	48	V _{DD}	Power Supply, +12V DC Regulated
24	Reserved	AUO Internal Use Only	49	V _{DD}	Power Supply, +12V DC Regulated
25	Reserved	AUO Internal Use Only	50	V _{DD}	Power Supply, +12V DC Regulated
			51	V _{DD}	Power Supply, +12V DC Regulated

LVDS Option = High/Open→NS

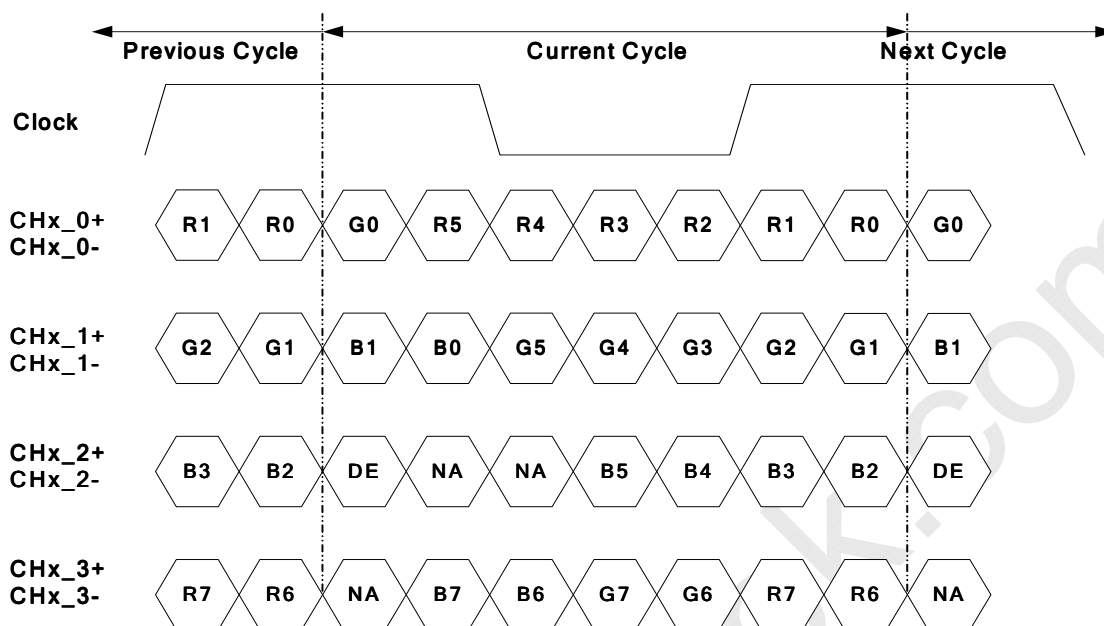

Note: x = 1, 2, 3, 4...

LVDS Option = Low→JEIDA

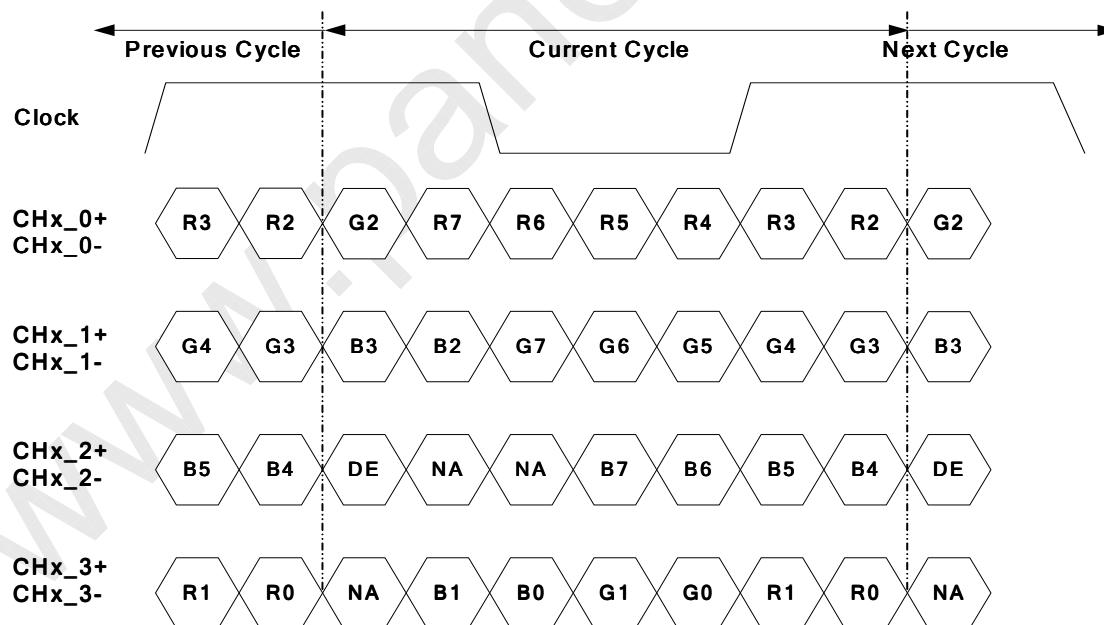

Note: x = 1, 2, 3, 4...

3.3 Signal Timing Specification

This is the signal timing required at the input of the user connector. All of the interface signal timing should be satisfied with the following specifications for its proper operation.

Timing Table

Signal	Item	Symbol	Min.	Typ.	Max	Unit
Vertical Section	Period	Tv	1090	1125	1480	Th
	Active	Tdisp (v)	1080			Th
	Blanking	Tblk (v)	10	45	400	Th
Horizontal Section	Period	Th	1030	1100	1325	Tclk
	Active	Tdisp (h)	960			Tclk
	Blanking	Tblk (h)	70	140	365	Tclk
Clock	Frequency	Fclk=1/Tclk	50	74.25	82	MHz
Vertical Frequency	Frequency	Fv	47	60	63	Hz
Horizontal Frequency	Frequency	Fh	60	67.5	73	KHz

Notes:

(1) Display position is specific by the rise of DE signal only.

Horizontal display position is specified by the rising edge of 1st DCLK after the rise of 1st DE, is displayed on the left edge of the screen.

(2) Vertical display position is specified by the rise of DE after a "Low" level period equivalent to eight times of horizontal period. The 1st data corresponding to one horizontal line after the rise of 1st DE is displayed at the top line of screen.

(3) If a period of DE "High" is less than 1920 DCLK or less than 1080 lines, the rest of the screen displays black.

(4) The display position does not fit to the screen if a period of DE "High" and the effective data period do not synchronize with each other.

3.4 Signal Timing Waveforms

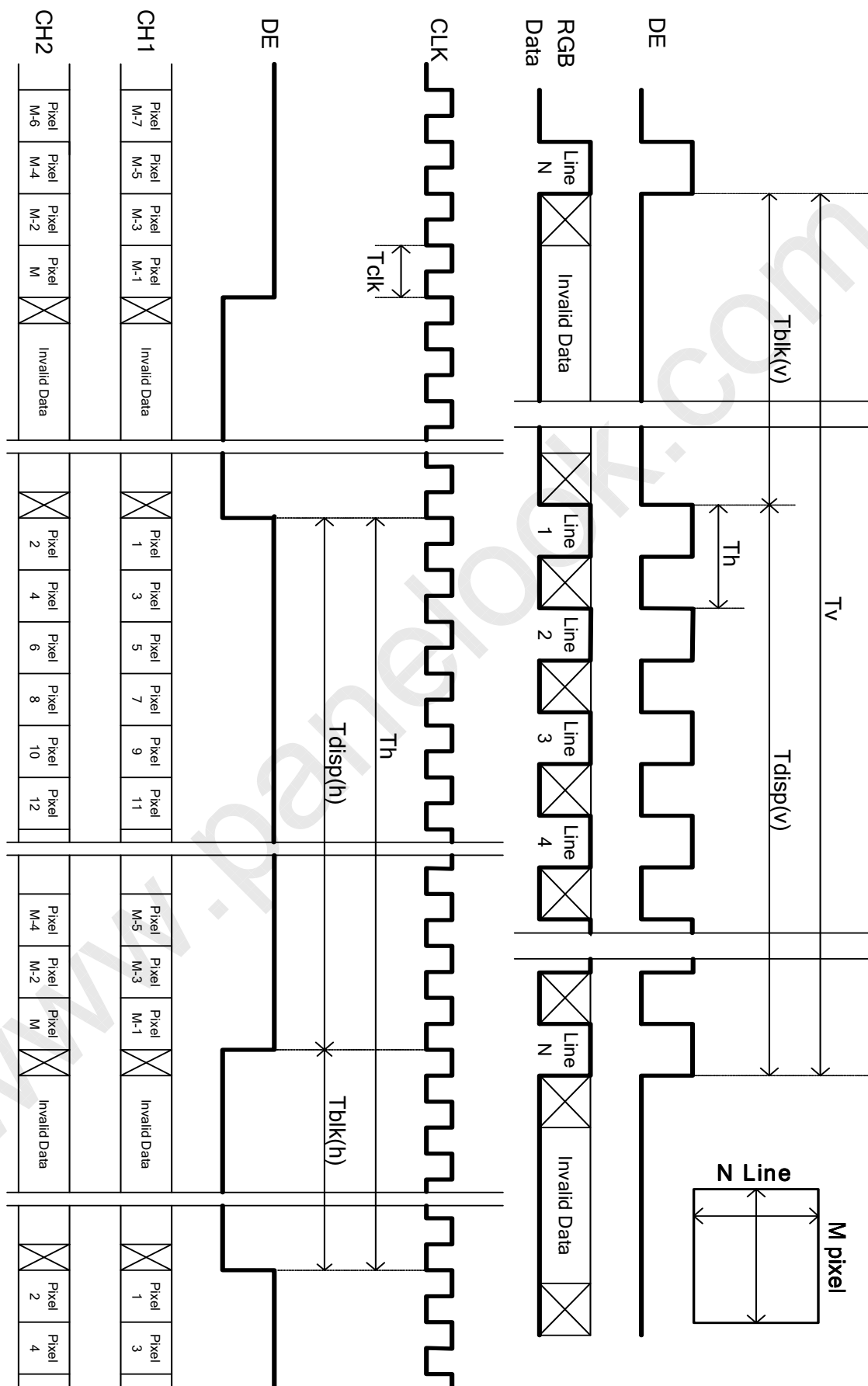

3.5 Color Input Data Reference

The brightness of each primary color (red, green and blue) is based on the 8-bit gray scale data input for the color; the higher the binary input, the brighter the color. The table below provides a reference for color versus data input.

COLOR DATA REFERENCE

Color		Input Color Data																							
		RED								GREEN								BLUE							
		MSB				LSB				MSB				LSB				MSB				LSB			
		R7	R6	R5	R4	R3	R2	R1	R0	G7	G6	G5	G4	G3	G2	G1	G0	B7	B6	B5	B4	B3	B2	B1	B0
Basic Color	Black	0	0	0	0	0	0	0	0	0	0	0	0	0	0	0	0	0	0	0	0	0	0	0	0
	Red(255)	1	1	1	1	1	1	1	1	0	0	0	0	0	0	0	0	0	0	0	0	0	0	0	0
	Green(255)	0	0	0	0	0	0	0	0	1	1	1	1	1	1	1	1	0	0	0	0	0	0	0	0
	Blue(255)	0	0	0	0	0	0	0	0	0	0	0	0	0	0	0	0	1	1	1	1	1	1	1	1
	Cyan	0	0	0	0	0	0	0	0	1	1	1	1	1	1	1	1	1	1	1	1	1	1	1	1
	Magenta	1	1	1	1	1	1	1	1	0	0	0	0	0	0	0	0	1	1	1	1	1	1	1	1
	Yellow	1	1	1	1	1	1	1	1	1	1	1	1	1	1	1	1	0	0	0	0	0	0	0	0
	White	1	1	1	1	1	1	1	1	1	1	1	1	1	1	1	1	1	1	1	1	1	1	1	1
R	RED(000)	0	0	0	0	0	0	0	0	0	0	0	0	0	0	0	0	0	0	0	0	0	0	0	0
	RED(001)	0	0	0	0	0	0	0	1	0	0	0	0	0	0	0	0	0	0	0	0	0	0	0	0

	RED(254)	1	1	1	1	1	1	1	0	0	0	0	0	0	0	0	0	0	0	0	0	0	0	0	0
	RED(255)	1	1	1	1	1	1	1	1	0	0	0	0	0	0	0	0	0	0	0	0	0	0	0	0
G	GREEN(000)	0	0	0	0	0	0	0	0	0	0	0	0	0	0	0	0	0	0	0	0	0	0	0	0
	GREEN(001)	0	0	0	0	0	0	0	0	0	0	0	0	0	0	1	0	0	0	0	0	0	0	0	0

	GREEN(254)	0	0	0	0	0	0	0	0	1	1	1	1	1	1	1	0	0	0	0	0	0	0	0	0
	GREEN(255)	0	0	0	0	0	0	0	0	1	1	1	1	1	1	1	1	0	0	0	0	0	0	0	0
B	BLUE(000)	0	0	0	0	0	0	0	0	0	0	0	0	0	0	0	0	0	0	0	0	0	0	0	0
	BLUE(001)	0	0	0	0	0	0	0	0	0	0	0	0	0	0	0	0	0	0	0	0	0	0	0	1

	BLUE(254)	0	0	0	0	0	0	0	0	0	0	0	0	0	0	0	0	1	1	1	1	1	1	1	0
	BLUE(255)	0	0	0	0	0	0	0	0	0	0	0	0	0	0	0	0	1	1	1	1	1	1	1	1

3.6 Power Sequence for LCD

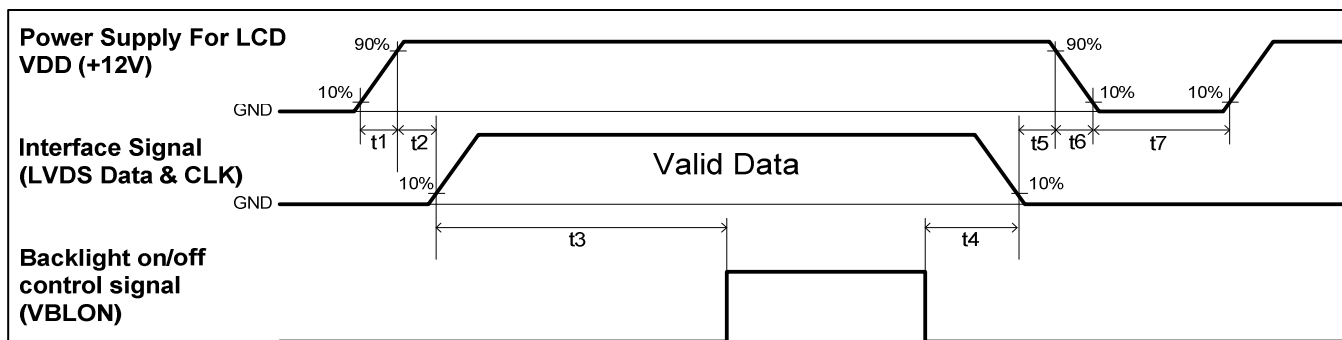

Parameter	Values			Unit
	Min.	Type.	Max.	
t1	0.4	---	30	ms
t2	0.1	---	---	ms
t3	300	---	---	ms
t4	0 ^{*1}	---	---	ms
t5	0	---	---	ms
t6	---	---	--- ^{*2}	ms
t7	500	---	---	ms

Note:

- (1) T4=0: concern for residual pattern before BLU turn off.
 (2) T6: voltage of VDD must decay smoothly after power-off. (customer system decide this value)

3.7 Backlight Specification

The backlight unit contains 4pcs light bar.

3.7.1 Electrical specification

	Item	Symbol		Condition	Spec			Unit	Note
					Min	Typ	Max		
1	Input Voltage	VDDB		-	21.6	24	26.4	VDC	-
2	Input Current	I _{DDB}		VDDB=24V	--	3.52	3.725	ADC	1
3	Input Power	P _{DDB}		VDDB=24V	--	84.5	89.4	W	1
4	Inrush Current	I _{RUSH}		VDDB=24V	-	-	7	ADC	2
5	On/Off control voltage	V _{BLOn}	ON	VDDB=24V	2	-	5.5	VDC	-
			OFF		0	-	0.8		-
6	On/Off control current	I _{BLOn}		VDDB=24V	-	-	1.5	mA	-
7	Dimming Control Voltage	V _{DIM}	MAX	VDDB=24V	3.0	-	3.3	VDC	-
			MIN		-	0	-	VDC	-
8	Dimming Control Current	I _{DIM}		VDDB=24V	-	-	2	mADC	-
9	Internal Dimming Ratio	DIM_R		VDDB=24V	20	-	100	%	3
10	External PWM Control Voltage	V _{EPWM}	MAX	VDDB=24V	2	-	3.3	VDC	-
			MIN	VDDB=24V	0	-	0.8		-
11	External PWM Control Current	I _{EPWM}		VDDB=24V	-	-	2	mADC	-
12	External PWM Duty ratio	D _{EPWM}		VDDB=24V	10	-	100	%	3
13	External PWM Frequency	F _{EPWM}		VDDB=24V	140	180	240	Hz	-

Note 1 : Dimming ratio= 100% (MAX) (Ta=25±5℃, Turn on for 45minutes)

Note 2: Measurement condition Rising time = 20ms (VDDB: 10%~90%);

Note 3: Less than10% dimming control is functional well and no backlight shutdown happened

3.7.2 Input Pin Assignment

LED Driver Connector: CI1114M1HR0-NH (Cvilux)

Pin No	Symbol	Description
1	VDDB	Operating Voltage Supply, +24V DC regulated
2	VDDB	Operating Voltage Supply, +24V DC regulated
3	VDDB	Operating Voltage Supply, +24V DC regulated
4	VDDB	Operating Voltage Supply, +24V DC regulated
5	VDDB	Operating Voltage Supply, +24V DC regulated
6	BLGND	Ground and Current Return
7	BLGND	Ground and Current Return
8	BLGND	Ground and Current Return
9	BLGND	Ground and Current Return
10	BLGND	Ground and Current Return
11	DET	BLU status detection Normal : 0~0.8V L Abnormal : Open collector
12	VBLON	BL On-Off control : BL On : High/Open (3.3V~5.5V); BL off : Low (0~0.8V/GND)
13	VDIM(**)	Internal PWM (0~3.3V for 20~100% Duty, open for 100%) < NC ; at External PWM mode >
14	PDIM	External PWM (10%~100% Duty, open for 100%)

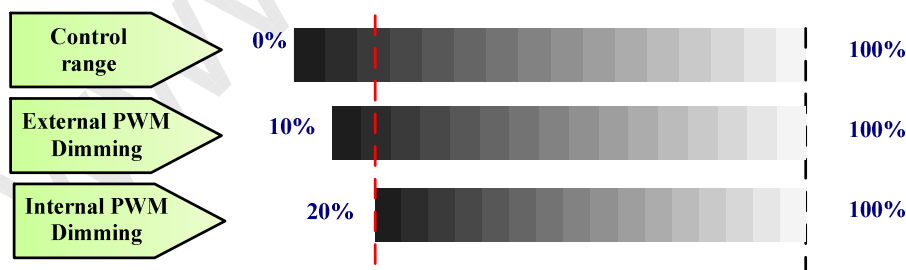

PWM Dimming : include Internal and External PWM Dimming

(Note*) If External PWM function includes 10% dimming ratio. Judge condition as below:

- (1) Backlight module must be lighted ON normally.
- (2) All protection function must work normally.
- (3) Uniformity and flicker could NOT be guaranteed

3.7.3 Power Sequence for LED Driver

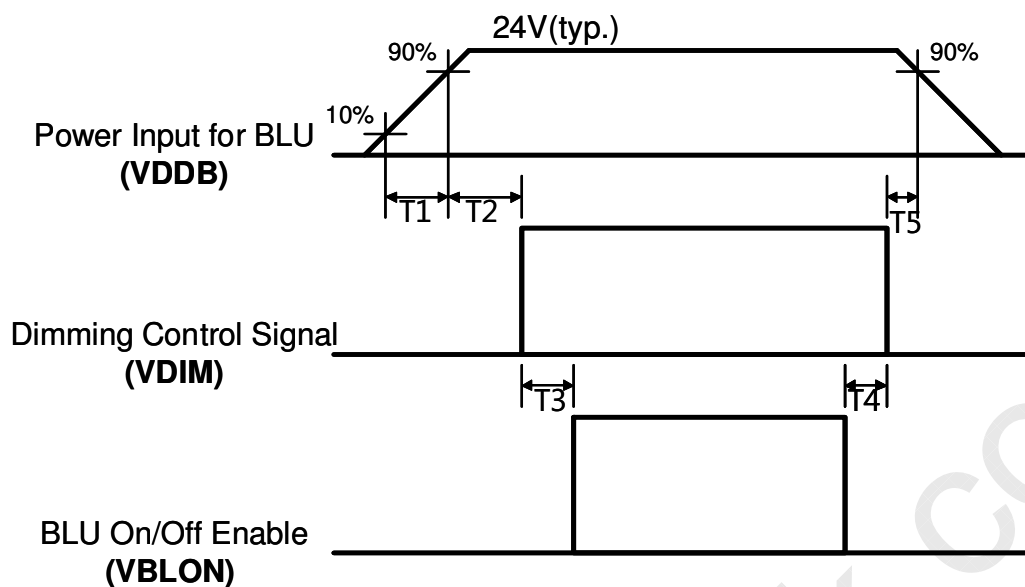

Dip condition for LED Driver

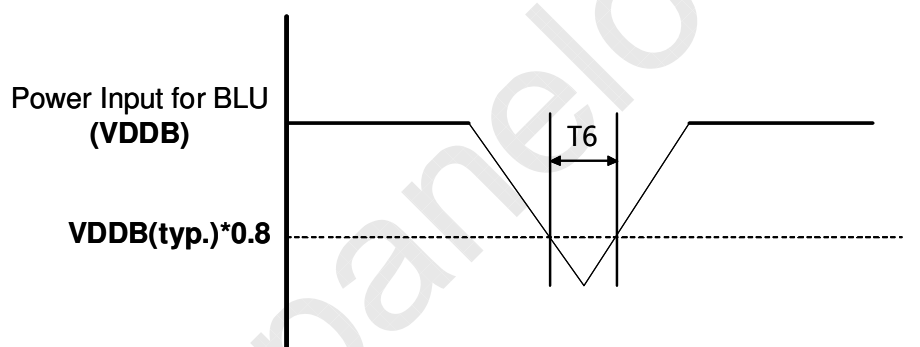

Parameter	Value			Units
	Min	Typ	Max	
T1	20	-	-	ms
T2	500	-	-	ms
T3	250	-	-	ms
T4	0	-	-	ms
T5	1	-	-	ms
T6	-	-	10	ms

4. Optical Specification

Optical characteristics are determined after the unit has been 'ON' and stable for approximately 45 minutes in a dark environment at 25°C. The values specified are at an approximate distance 50cm from the LCD surface at a viewing angle of φ and θ equal to 0°.

Fig.1 presents additional information concerning the measurement equipment and method.

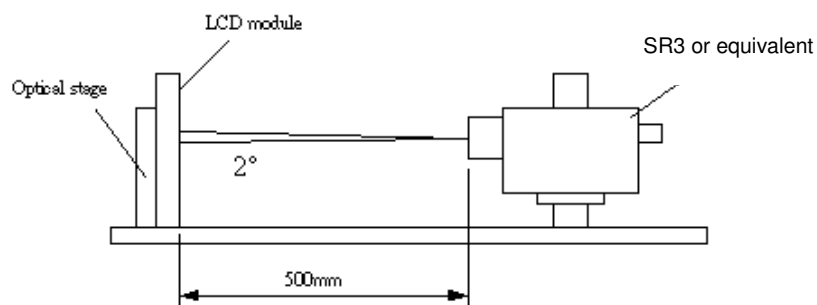

Parameter	Symbol	Values			Unit	Notes
		Min.	Typ.	Max		
Contrast Ratio	CR	3600	4000	--		1
Surface Luminance (White)	L_{WH}	320	400	--	cd/m ²	2
Luminance Variation	$\delta_{WHITE(\varphi P)}$	--	--	1.3		3
Response Time (G to G)	T_Y	--	6.5	--	ms	4
Color Gamut	NTSC		72		%	
Color Coordinates						
Red	R_X	Typ.-0.03	0.640	Typ.+0.03		
	R_Y		0.330			
Green	G_X		0.300			
	G_Y		0.620			
Blue	B_X		0.150			
	B_Y		0.050			
White	W_X		0.280			
	W_Y		0.290			
Viewing Angle						
x axis, right($\varphi=0^\circ$)	θ_r	--	89	--	degree	5
x axis, left($\varphi=180^\circ$)	θ_l	--	89	--	degree	
y axis, up($\varphi=90^\circ$)	θ_u	--	89	--	degree	
y axis, down ($\varphi=270^\circ$)	θ_d	--	89	--	degree	

Note:

1. Contrast Ratio (CR) is defined mathematically as:

$$\text{Contrast Ratio} = \frac{\text{Surface Luminance of } L_{\text{on5}}}{\text{Surface Luminance of } L_{\text{off5}}}$$

2. Surface luminance is luminance value at point 5 across the LCD surface 50cm from the surface with all pixels displaying white. From more information see FIG 2. At driver current $I_{\text{DDB}} = 3.52\text{A}$, $L_{\text{WH}} = L_{\text{on5}}$ where L_{on5} is the luminance with all pixels displaying white at center 5 location.

3. The variation in surface luminance, δ_{WHITE} is defined (center of Screen) as:

$$\delta_{\text{WHITE(9P)}} = \text{Maximum}(L_{\text{on1}}, L_{\text{on2}}, \dots, L_{\text{on9}}) / \text{Minimum}(L_{\text{on1}}, L_{\text{on2}}, \dots, L_{\text{on9}})$$

4. Response time T_{γ} is the average time required for display transition by switching the input signal for five luminance ratio (0%,25%,50%,75%,100% brightness matrix) and is based on $F_v = 60\text{Hz}$ to optimize.

(See Fig. 3)

Measured Response Time		Target				
		0%	25%	50%	75%	100%
Start	0%		0% to 25%	0% to 50%	0% to 75%	0% to 100%
	25%	25% to 0%		25% to 50%	25% to 75%	25% to 100%
	50%	50% to 0%	50% to 25%		50% to 75%	50% to 100%
	75%	75% to 0%	75% to 25%	75% to 50%		75% to 100%
	100%	100% to 0%	100% to 25%	100% to 50%	100% to 75%	

5. Viewing angle is the angle at which the contrast ratio is greater than 10. The angles are determined for the horizontal or x axis and the vertical or y axis with respect to the z axis which is normal to the LCD surface. For more information see FIG4.

FIG. 2 Luminance

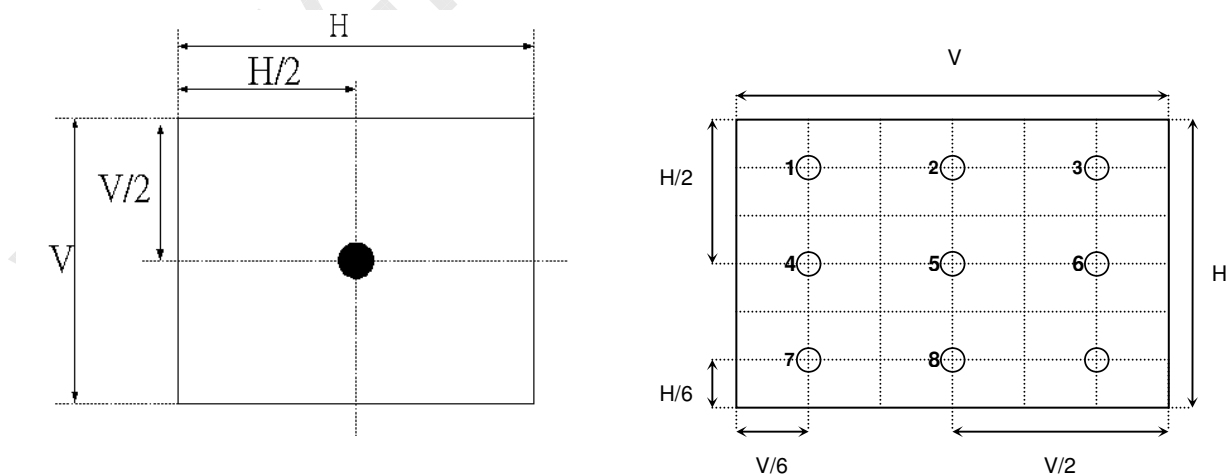
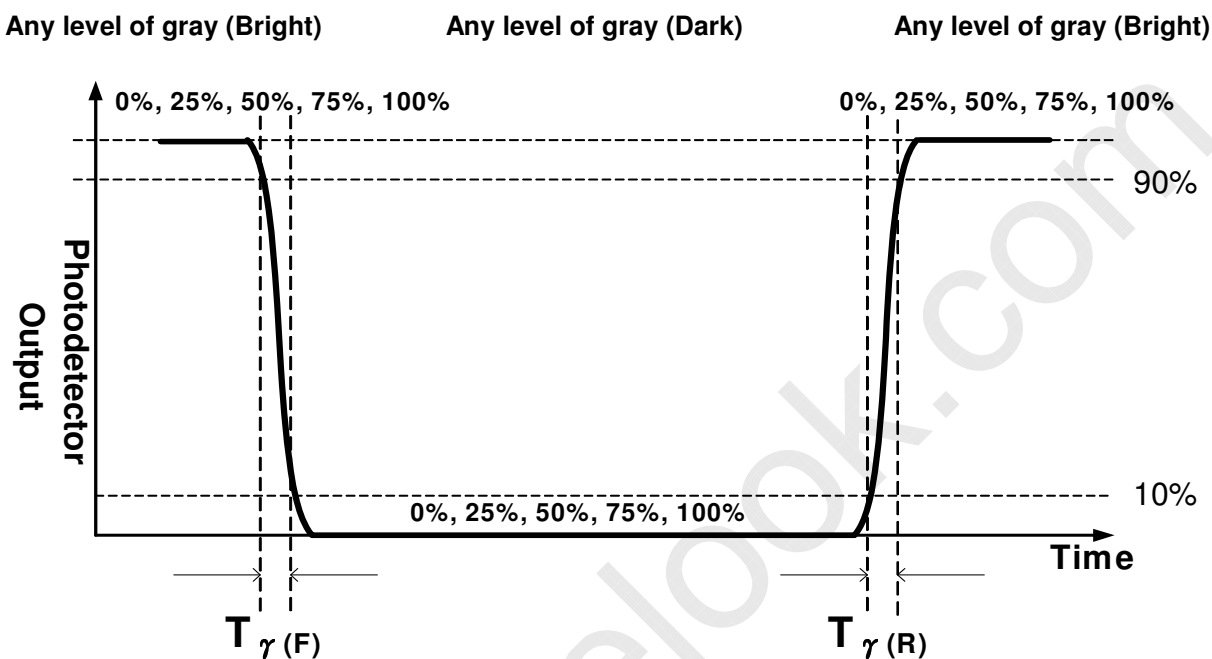
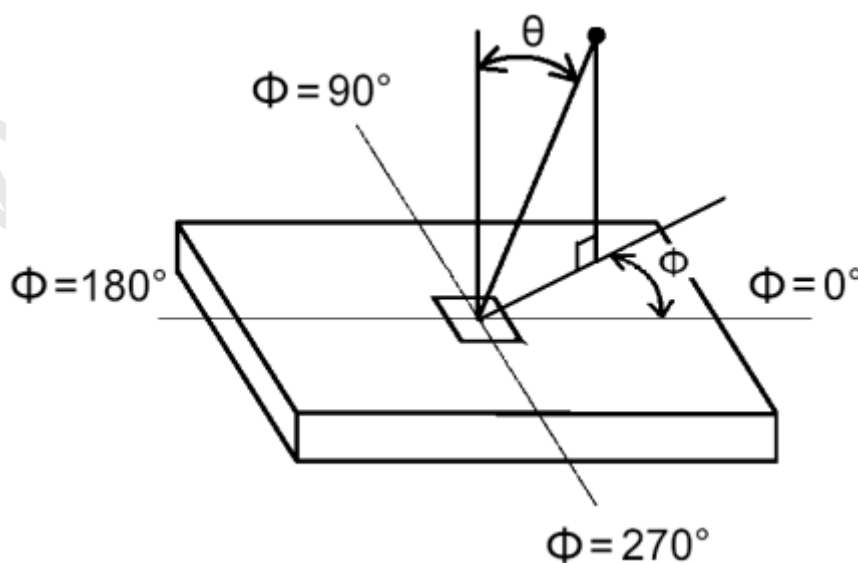

FIG.3 Response Time

The response time is defined as the following figure and shall be measured by switching the input signal for “any level of gray (bright)” and “any level of gray (dark)”.

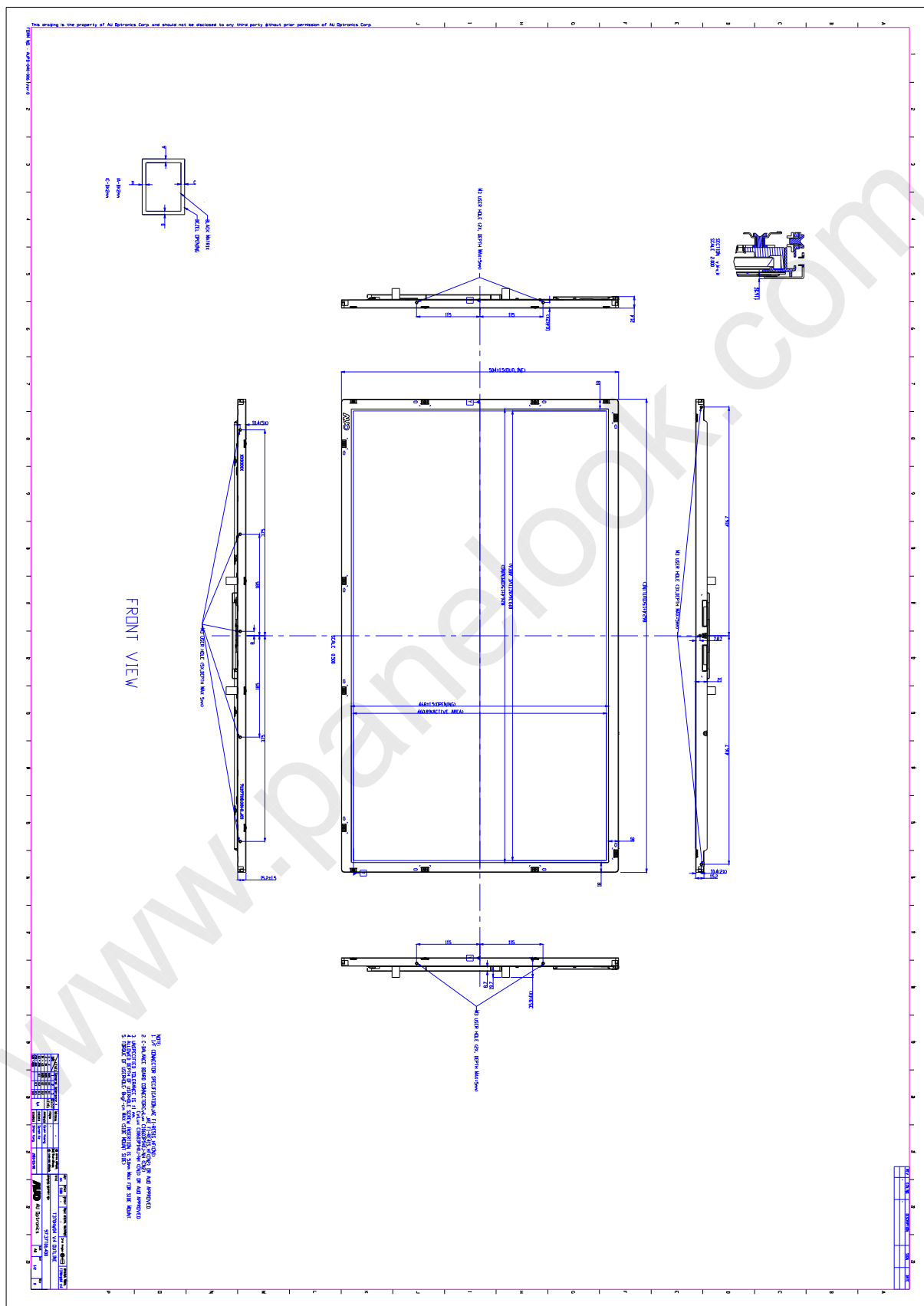

FIG.4 Viewing Angle

5. Mechanical Characteristics

The contents provide general mechanical characteristics for the model T370HW04 V4. In addition the figures in the next page are detailed mechanical drawing of the LCD.

Outline Dimension	Horizontal	862.4 mm
	Vertical	504.0 mm
	Depth	22.4mm (to T-CON cover)
Bezel Opening	Horizontal	826.4 mm
	Vertical	468.0 mm
Active Display Area	Horizontal	819.36mm
	Vertical	460.89mm
Weight	7100 g (Typ.)	
Surface Treatment	Anti-Glare, 3H	

Front View





Back View

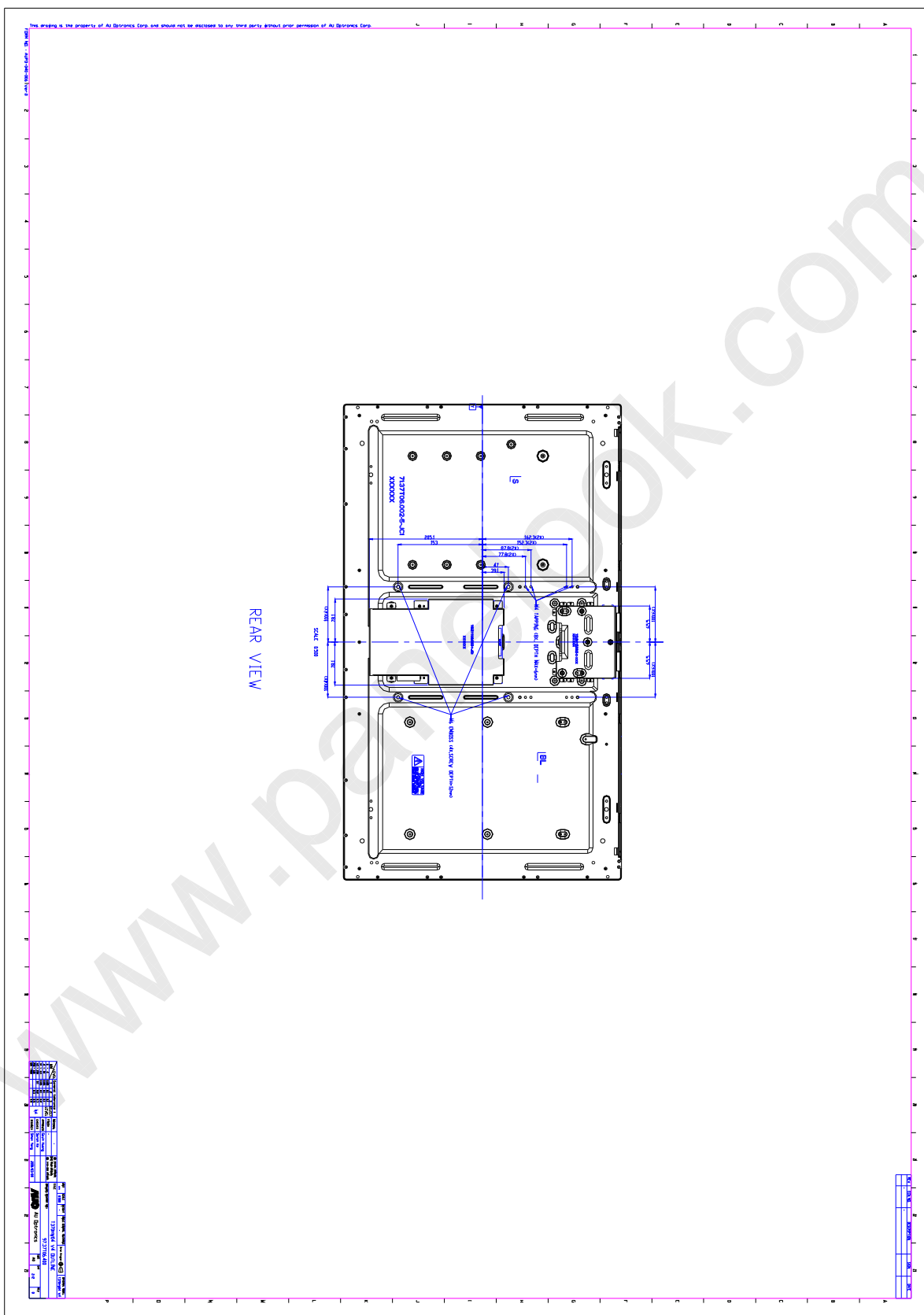

6. Reliability Test Items

	Test Item	Q'ty	Condition
1	High temperature storage test	3	60°C, 300hrs
2	Low temperature storage test	3	-20°C, 300hrs
3	High temperature operation test	3	50°C, 300hrs
4	Low temperature operation test	3	-5°C, 300hrs
5	Vibration test (non-operation)	3	Wave form: random Vibration level: 1.5G RMS Bandwidth: 10-300Hz, Duration: X, Y, Z 30min One time each direction
6	Shock test (non-operation)	3	Shock level: 50G Waveform: half sine wave, 11ms Direction: ±X, ±Y, ±Z, One time each direction
7	Vibration test (With carton)	4	Random wave (1.5G RMS, 10-200Hz) 30mins/ Per each X,Y,Z axes
8	Drop test (With carton)	4	Height: 38.1cm (ASTMD4169-1) 1 corner, 3 edges, 6 flats(ASTM D5276)

7. International Standard

7.1 Safety

- (1) UL 60950-1, UL 60065; Standard for Safety of Information Technology Equipment Including electrical Business Equipment.
- (2) IEC 60950-1 : 2001, IEC 60065:2001 ; Standard for Safety of International Electrotechnical Commission
- (3) EN 60950: 2001+A11, EN 60065:2002+A1:2006; European Committee for Electrotechnical Standardization (CENELEC), EUROPEAN STANDARD for Safety of Information Technology Equipment Including Electrical Business Equipment.

7.2 EMC

- (1) ANSI C63.4 "Methods of Measurement of Radio-Noise Emissions from Low-Voltage Electrical and Electrical Equipment in the Range of 9kHz to 40GHz." American National standards Institute(ANSI), 1992
- (2) C.I.S.P.R "Limits and Methods of Measurement of Radio Interface Characteristics of Information Technology Equipment." International Special committee on Radio Interference.
- (3) EN 55022 "Limits and Methods of Measurement of Radio Interface Characteristics of Information Technology Equipment." European Committee for Electrotechnical Standardization. (CENELEC), 1998



8. Packing

8-1 DEFINITION OF LABEL:

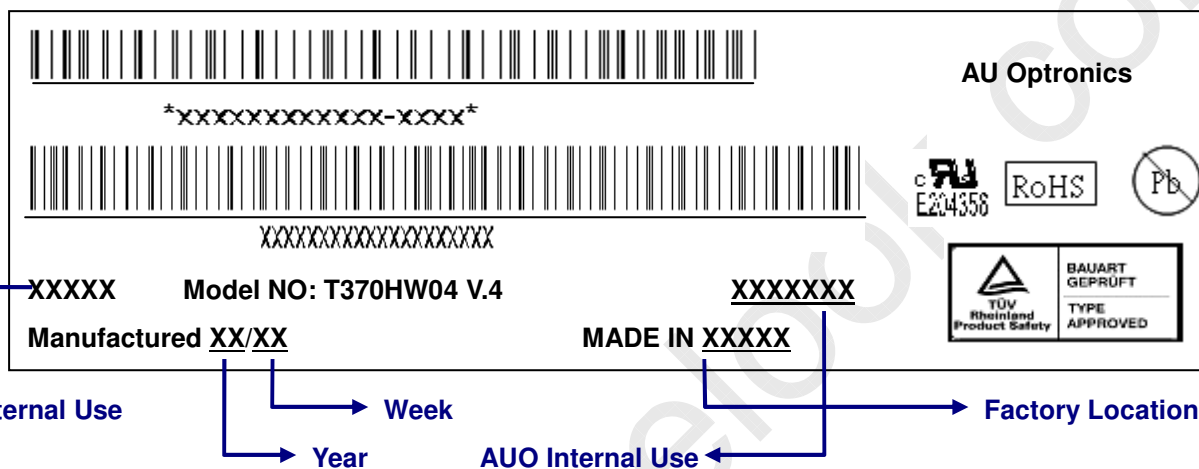
A. Panel Label:



Green mark description

- (1) For Pb Free Product, AUO will add  for identification.
 - (2) For RoHs compatible products, AUO will add  for identification.
- Note: The green Mark will be present only when the green documents have been ready by AUO internal green team. (definition of green design follows the AUO green design checklist.)

B. Carton Label:

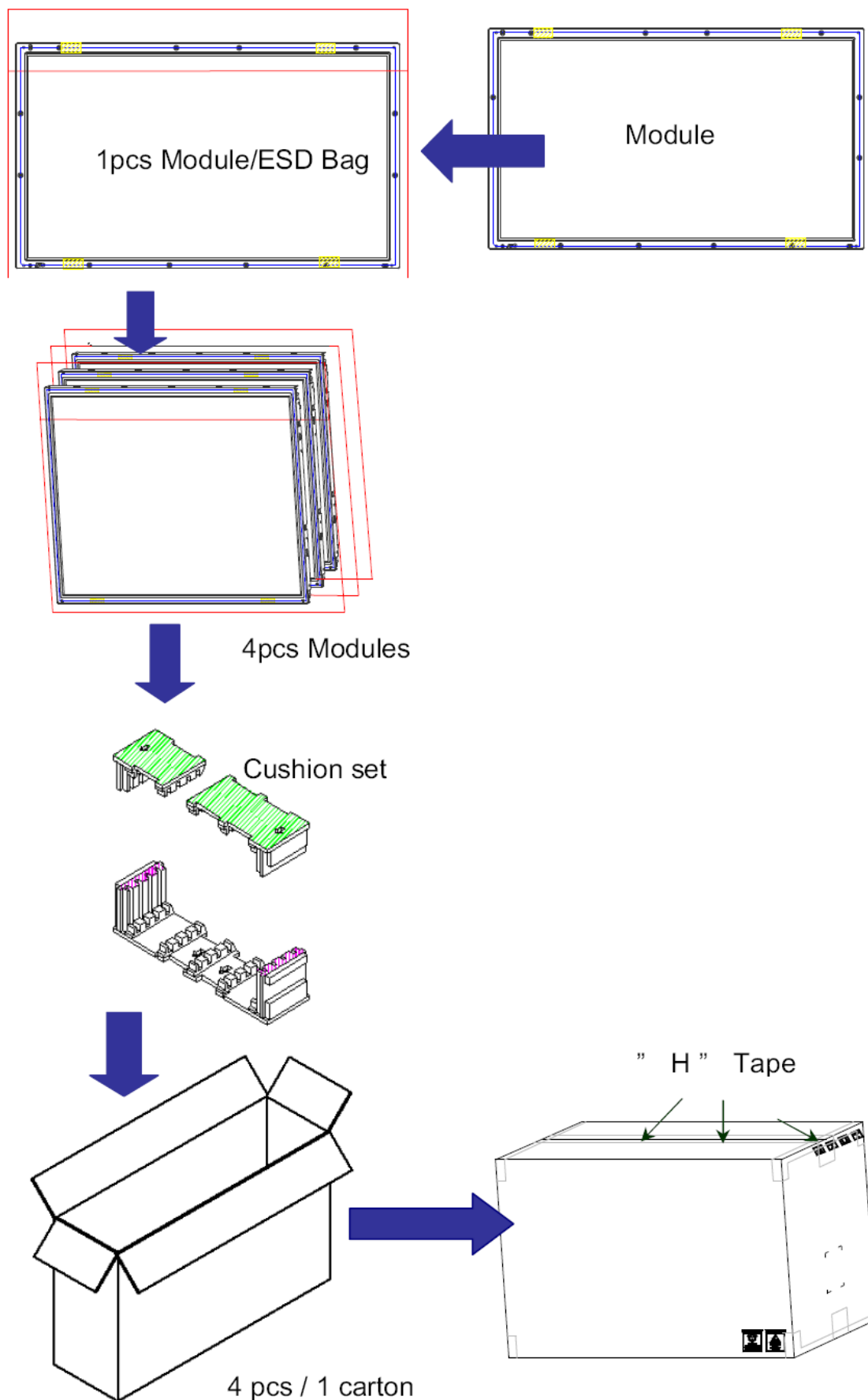

8-2 PACKING METHODS:

8-3 Pallet and Shipment Information

	Item	Specification			Packing Remark
		Qty.	Dimension	Weight (kg)	
1	Packing BOX	4pcs/box	965(L)*280(W)*610(H)	32.5	
2	Pallet	1	1150(L)*980(W)*132(H)	16	
3	Boxes per Pallet	8 boxes/pallet			
4	Panels per Pallet	32 pcs/pallet			
	Pallet after packing	32	1150(L)*980(W)*1352(H)	276	

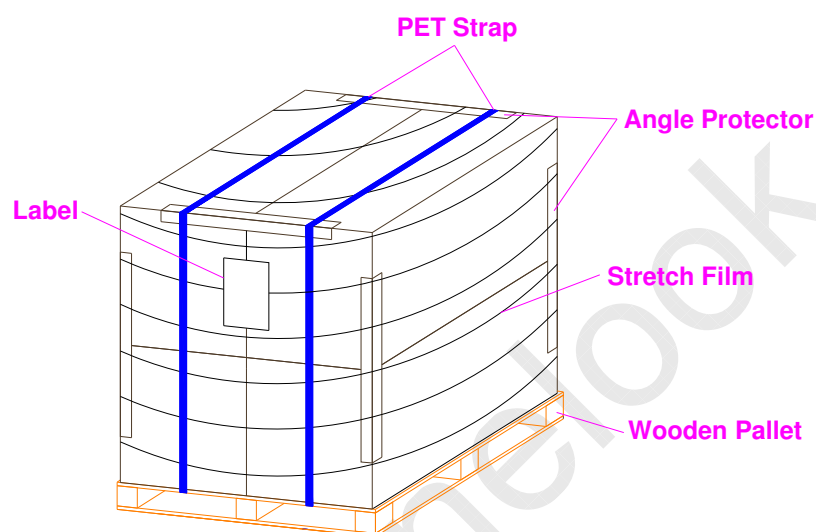

8. PRECAUTIONS

Please pay attention to the followings when you use this TFT LCD module.

9-1 MOUNTING PRECAUTIONS

- (1) You must mount a module using holes arranged in four corners or four sides.
- (2) You should consider the mounting structure so that uneven force (ex. twisted stress) is not applied to module. And the case on which a module is mounted should have sufficient strength so that external force is not transmitted directly to the module.
- (3) Please attach the surface transparent protective plate to the surface in order to protect the polarizer. Transparent protective plate should have sufficient strength in order to resist external force.
- (4) You should adopt radiation structure to satisfy the temperature specification.
- (5) Acetic acid type and chlorine type materials for the cover case are not desirable because the former generates corrosive gas of attacking the polarizer at high temperature and the latter cause circuit broken by electro-chemical reaction.
- (6) Do not touch, push or rub the exposed polarizer with glass, tweezers or anything harder than HB pencil lead. And please do not rub with dust clothes with chemical treatment. Do not touch the surface of polarizer for bare hand or greasy cloth. (Some cosmetics are detrimental to the polarizer.)
- (7) When the surface becomes dusty, please wipe gently with absorbent cotton or other soft materials like chamois soaks with petroleum benzene. Normal-hexane is recommended for cleaning the adhesives used to attach front/ rear polarizer. Do not use acetone, toluene and alcohol because they cause chemical damage to the polarizer.
- (8) Wipe off saliva or water drops as soon as possible. Their long time contact with polarizer causes deformations and color fading.
- (9) Do not open the case because inside circuits do not have sufficient strength.

9-2 OPERATING PRECAUTIONS

- (1) The device listed in the product specification sheets was designed and manufactured for TV application
- (2) The spike noise causes the mis-operation of circuits. It should be lower than following voltage:
 $V = \pm 200\text{mV}$ (Over and under shoot voltage)
- (3) Response time depends on the temperature. (In lower temperature, it becomes longer..)
- (4) Brightness of CCFL depends on the temperature. (In lower temperature, it becomes lower.) And in lower temperature, response time (required time that brightness is stable after turned on) becomes longer.
- (5) Be careful for condensation at sudden temperature change. Condensation makes damage to polarizer or electrical contacted parts. And after fading condensation, smear or spot will occur.
- (6) When fixed patterns are displayed for a long time, remnant image is likely to occur.
- (7) Module has high frequency circuits. Sufficient suppression to the electromagnetic interference shall

be done by system manufacturers. Grounding and shielding methods may be important to minimize the interface.

9-3 ELECTROSTATIC DISCHARGE CONTROL

Since a module is composed of electronic circuits, it is not strong to electrostatic discharge. Make certain that treatment persons are connected to ground through wristband etc. And don't touch interface pin directly.

9-4 PRECAUTIONS FOR STRONG LIGHT EXPOSURE

Strong light exposure causes degradation of polarizer and color filter.

9-5 STORAGE

When storing modules as spares for a long time, the following precautions are necessary.

- (1) Store them in a dark place. Do not expose the module to sunlight or fluorescent light. Keep the temperature between 5°C and 35°C at normal humidity.
- (2) The polarizer surface should not come in contact with any other object. It is recommended that they be stored in the container in which they were shipped.

9-6 HANDLING PRECAUTIONS FOR PROTECTION FILM

- (1) The protection film is attached to the bezel with a small masking tape. When the protection film is peeled off, static electricity is generated between the film and polarizer. This should be peeled off slowly and carefully by people who are electrically grounded and with well ion-blown equipment or in such a condition, etc.
- (2) When the module with protection film attached is stored for a long time, sometimes there remains a very small amount of glue still on the bezel after the protection film is peeled off.
- (3) You can remove the glue easily. When the glue remains on the bezel or its vestige is recognized, please wipe them off with absorbent cotton waste or other soft material like chamois soaked with normal-hexane.