



Document Version: 1.5

Date:2008/7/09

Product Specifications

40" Full HD Color TFT-LCD Module

Model Name: T400HW01 V4

() Preliminary Specifications

(* Final Specifications



Contents

No	
	CONTENTS
	RECORD OF REVISIONS
1	GENERAL DESCRIPTION
2	ABSOLUTE MAXIMUM RATINGS
3	ELECTRICAL SPECIFICATION
3-1	ELECTRICAL CHARACTERISTICS
3-2	INTERFACE CONNECTIONS
3-3	SIGNAL TIMING SPECIFICATION
3-4	SIGNAL TIMING WAVEFORM
3-5	COLOR INPUT DATA REFERENCE
3-6	POWER SEQUENCE
3-7	BACK LIGHT POWER SPECIFICATION
4	OPTICAL SPECIFICATION
5	MECHANICAL CHARACTERISTICS
6	RELIABILITY TEST ITEMS
7	INTERNATIONAL STANDARD
8	PACKING
9	PRECAUTION



Record of Revision

Version	Date	Page.	Old Description	New Description	Remark
1.0	2007/12/24		First release	N/A	N/A
1.1	2008/02/15	11		Add Signal Timing Specification (50Hz)	
1.2	2008/3/26	21		Update Mechanical figure	
1.3	2008/3/28	16		Update Lamp Striking Voltage	
1.4	2008/4/21	15		Update Timing Sequence	
1.5	2008/7/9	15		Update CN2 polarity	

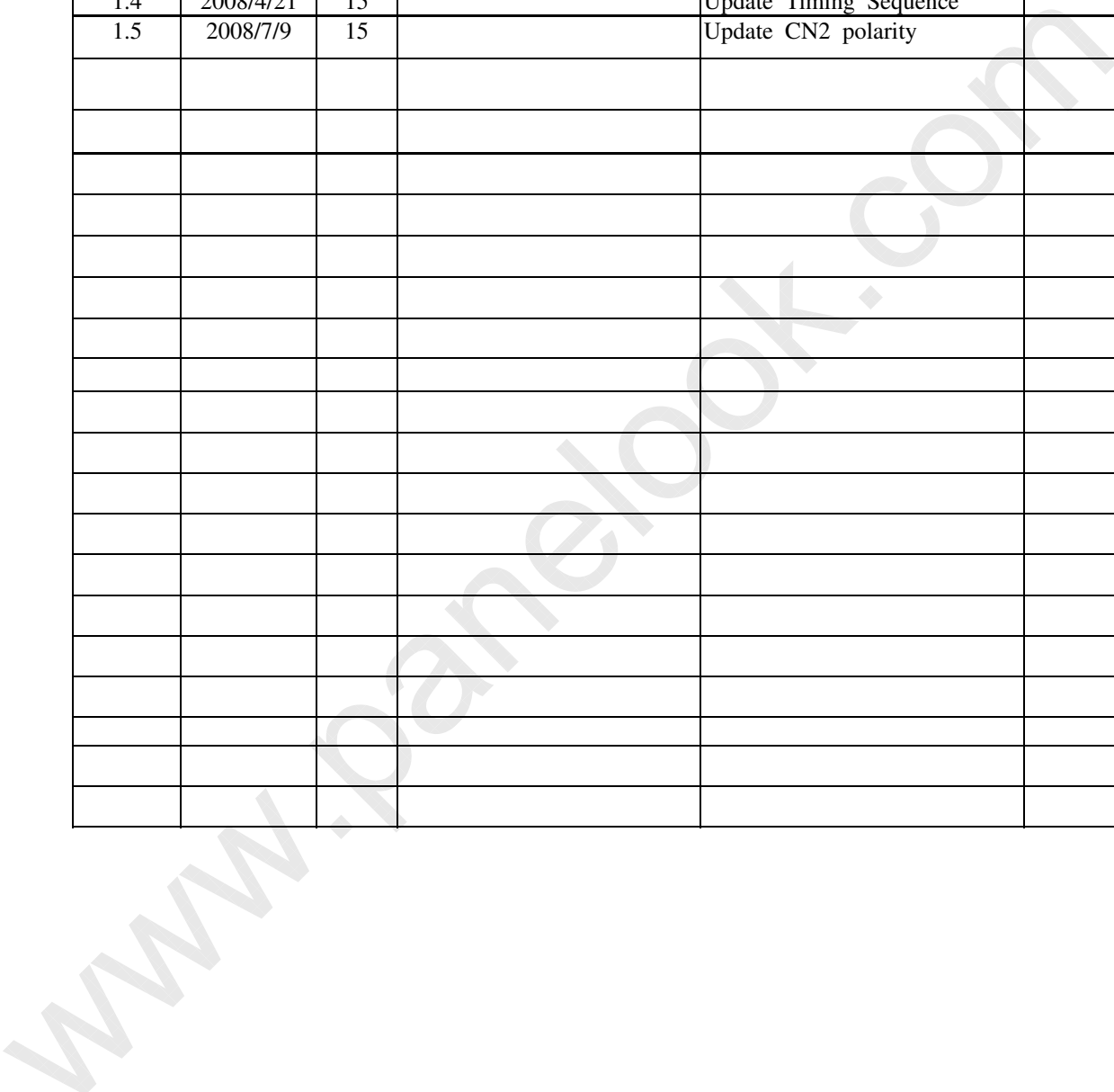



1. General Description

This specification applies to the 40.0 inch Color TFT-LCD Module T400HW01 V4. This LCD module has a TFT active matrix type liquid crystal panel 1,920x1,080 pixels, and diagonal size of 40.0 inch. This module supports 1,920x1,080 mode. Each pixel is divided into Red, Green and Blue sub-pixels or dots which are arranged in vertical stripes. Gray scale or the brightness of the sub-pixel color is determined with a 8-bit gray scale signal for each dot.

The T400HW01 V4 has been designed to apply the 8-bit 2 channel LVDS interface method. It is intended to support displays where high brightness, wide viewing angle, high color saturation, and high color depth are very important.

* General Information

Items	Specification	Unit	Note
Active Screen Size	40.00	inch	
Display Area	885.6(H) x 498.15(V)	mm	
Outline Dimension	952.0(H) x 551.0 (V) x 53.2(D)	mm	With Balance board
Driver Element	a-Si TFT active matrix		
Display Colors	8 bit, 16.7M	Colors	
Number of Pixels	1,920x1,080	Pixel	
Pixel Pitch	0.46125 (H) x 0.46125(W)	mm	
Color Gamut	72	%	NTSC
Pixel Arrangement	RGB vertical stripe		
Display Operation Mode	Normally Black		
Surface Treatment	Anti-Glare, Hard-Coating(3H),Haze=11%		



2. Absolute Maximum Ratings

The followings are maximum values which, if exceeded, may cause faulty operation or damage to the unit

Item	Symbol	Min.	Max	Unit	Note
Logic/LCD Drive Voltage	V_{DD}	-0.3	14.0	V_{DC}	1
Input Voltage of Signal	V_{in}	-0.3	3.6	V_{DC}	1
Operating Temperature	TOP	0	+50	°C	2
Operating Humidity	HOP	10	90	%RH	2
Storage Temperature	TST	-20	+60	°C	2
Storage Humidity	HST	10	90	%RH	2
Shock (non-operation)	$\pm x, \pm y$	--	50	G	3
Shock (non-operation)	$\pm z$	--	50	G	3
Vibration (non-operation)		--	1.5	G	4

Note 1: Duration = 50ms

Note 2: Maximum Wet-Bulb should be 39°C and No condensation.

Note 3: Sine wave, 11ms, direction: $\pm x, \pm y, \pm z$ (one time each direction)

Note 4: Wave form: random, vibration level: 1.5G RMS, Bandwidth: 10--300Hz
Duration: X, Y, Z 30min (one time each direction)

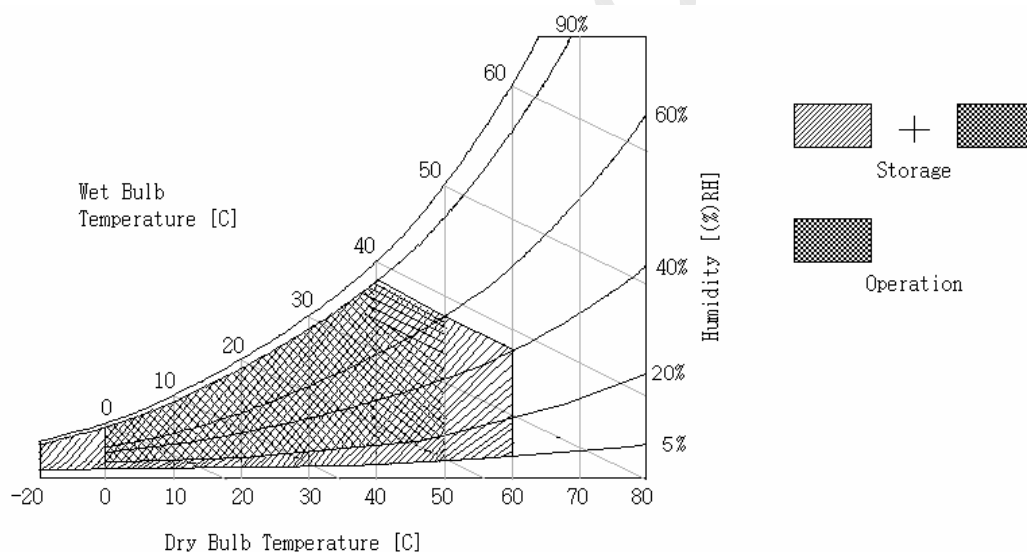



3. Electrical Specification

The T400HW01 V4 requires two power inputs. One is employed to power the LCD electronics and to drive the TFT array and liquid crystal. The second input, which powers the CCFL, is typically generated by an integrate power (I/P) system.

3.1 Electrical Characteristics

Parameter		Symbol	Value			Unit	Note
			Min.	Typ.	Max		
Power Supply Input Voltage		V_{DD}	10.8	12	13.2	V_{DC}	
Power Supply Input Current		I_{DD}	--	1.08	1.2	A	1
Power Consumption		P_C	--	13	15.84	Watt	1
Inrush Current		I_{RUSH}	--	--	4.5	A	5
LVDS Interface	Differential Input High Threshold Voltage	V_{TH}	--	--	+100	mV_{DC}	4
	Differential Input Low Threshold Voltage	V_{TL}	-100	--	--	mV_{DC}	4
	Common Input Voltage	V_{CIM}	1.10	1.25	1.40	V_{DC}	
CMOS Interface	Input High Threshold Voltage	V_{IH} (High)	2.4	--	3.3	V_{DC}	
	Input Low Threshold Voltage	V_{IL} (Low)	0	--	0.7	V_{DC}	
Backlight Power Consumption		P_{BL}	160	170	180	Watt	2
Life Time			50000	60000	--	Hours	3

The performance of the Lamp in LCD panel, for example life time or brightness, is extremely influenced by the characteristics of the balance board and I/P board. All the parameters should be carefully designed as not to produce too much leakage current from high-voltage output. While design or order balance board, please make sure unwanted lighting caused by the mismatch of the lamp and balance board (no lighting, flicker, etc) never occurs. After confirmation, the LCD Panel should be operated in the same condition as installed in your instrument.



Do not attach a conducting tape to lamp connecting wire. If the lamp wire attach to conducting tape, TFT-LCD Module has a low luminance and the inverter has abnormal action, because leakage current occurs between lamp wire and conducting tape.

The relative humidity must not exceed 80% non-condensing at temperatures of 40°C or less. At temperatures greater than 40°C the wet bulb temperature must not exceed 39°C. When operate at low temperatures, the brightness of CCFL will drop and the lifetime of CCFL will be reduced.

Note:

1. $V_{DD}=12.0V$, $f_V=60Hz$, $f_{CLK}=81.5Mhz$, $25^{\circ}C$, V_{DD} duration time= $400\mu s$, test pattern: white pattern
2. The power consumption shown above is tested by lamp current $I_L=8.5mA$ and used by IP JIG.
3. The life is determined as the time at which luminance of the lamp is 50% compared to that of initial value at the typical lamp current on condition of continuous operating at $25\pm 2^{\circ}C$.
4. $V_{CIM}=1.25V$

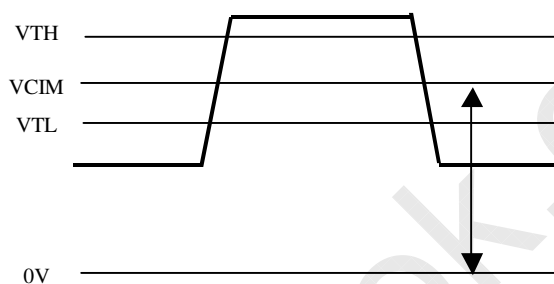
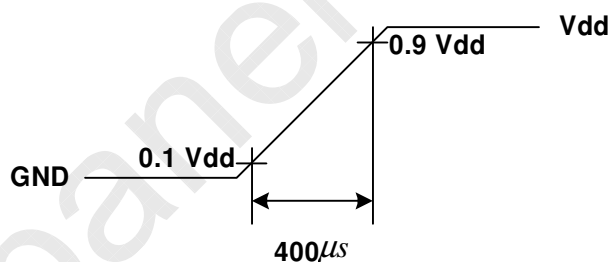

Figure: LVDS Differential Voltage

5. Measurement condition: rising time= $400\mu s$





3.2 Interface Connections

- LCD connector: FI-RE51S-HF (JAE)
- Mating connector: FI-RE51S-HL (JAE)

PIN #	Signal Name	Description
1	V _{DD}	12V power supply
2	V _{DD}	12V power supply
3	V _{DD}	12V power supply
4	V _{DD}	12V power supply
5	V _{DD}	12V power supply
6	GND	Ground
7	GND	Ground
8	GND	Ground
9	GND	Ground
10	RO_0-	Negative(-) LVDS differential data input
11	RO_0+	Positive(+) LVDS differential data input
12	RO_1-	Negative(-) LVDS differential data input
13	RO_1+	Positive(+) LVDS differential data input
14	RO_2-	Negative(-) LVDS differential data input
15	RO_2+	Positive(+) LVDS differential data input
16	GND	Ground
17	RO_CLK-	Clock Signal(-)
18	RO_CLK+	Clock Signal(+)
19	GND	Ground
20	RO_3-	Negative(-) LVDS differential data input
21	RO_3+	Positive(+) LVDS differential data input
22	NC	No connection
23	NC	No connection
24	GND	Ground
25	RE_0-	Negative(-) LVDS differential data input
26	RE_0+	Positive(+) LVDS differential data input



PIN #	Signal Name	Description
27	RE_1-	Negative(-) LVDS differential data input
28	RE_1+	Positive(+) LVDS differential data input
29	RE_2-	Negative(-) LVDS differential data input
30	RE_2+	Positive(+) LVDS differential data input
31	GND	Ground
32	RE_CLK-	Clock Signal(-)
33	RE_CLK+	Clock Signal(+)
34	GND	Ground
35	RE_3-	Negative(-) LVDS differential data input
36	RE_3+	Positive(+) LVDS differential data input
37	NC	No connection
38	NC	No connection
39	GND	Ground
40	SCL	EEPROM Serial Clock
41	SDA	EEPROM Serial Data
42	NC	No connection
43	WP	EEPROM Write Protection
44	NC	No connection
45	LVDS	Select LVDS data order (NS: High/Open, JEIDA: Low)
46	NC	No connection
47	NC	No connection
48	AGING	No Connect (AUO Aging Only)
49	NC (reserved)	No connection (AUO internal use)
50	NC (reserved)	No connection (AUO internal use)
51	NC (reserved)	No connection (AUO internal use)



LVDS Option = High/Open → NS

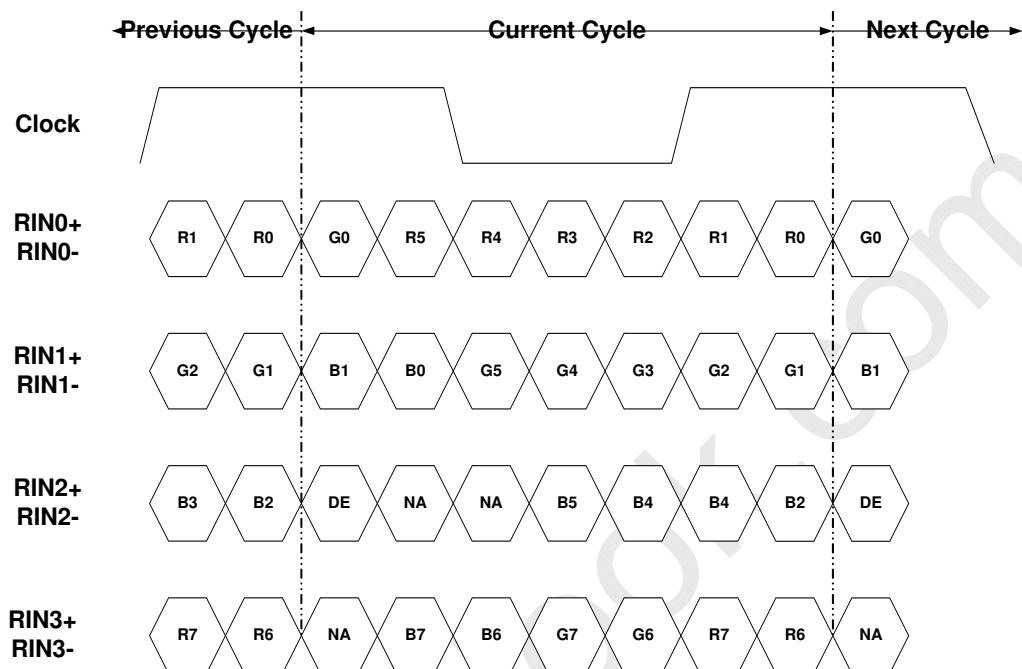

LVDS Option = Low → JEIDA

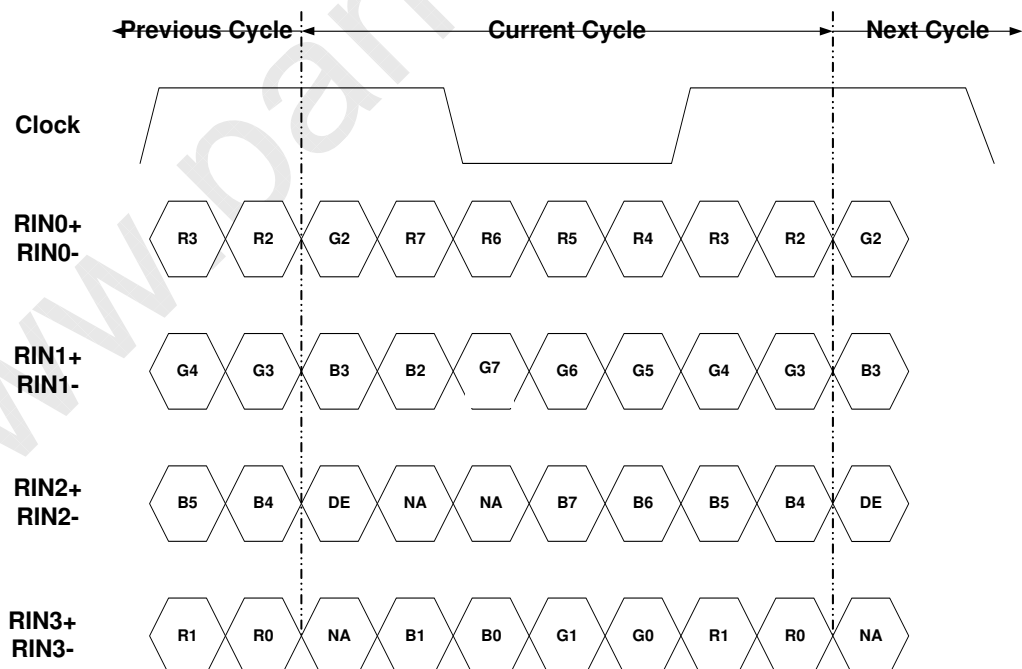



3.3 Signal Timing Specification

This is the signal timing required at the input of the user connector. All of the interface signal timing should be satisfied with the following specifications for its proper operation.

Timing Table (DE only Mode)
For 60Hz

Signal	Item	Symbol	Min.	Typ.	Max	Unit
Vertical Section	Period	T_V	1090	1130	1200	T_H
	Active	$T_{DISP}(V)$	1080			T_H
	Blanking	$T_{BLK}(V)$	10	50	120	T_H
Horizontal Section	Period	T_H	1090	1100	1120	T_{CLK}
	Active	$T_{DISP}(H)$	960			T_{CLK}
	Blanking	$T_{BLK}(H)$	130	140	160	T_{CLK}
Clock	Period	T_{CLK}	14.766	13.41	11.81	ns
	Frequency	F_{CLK}	67.722	74.58	84.672	MHz
Vertical Frequency	Frequency	F_V	57	60	63	Hz
Horizontal Frequency	Frequency	F_H	62.13	67.8	75.6	KHz

For 50Hz

Signal	Item	Symbol	Min.	Typ.	Max	Unit
Vertical Section	Period	T_V	1330	1356	1410	T_H
	Active	$T_{DISP}(V)$	1080			T_H
	Blanking	$T_{BLK}(V)$	250	276	330	T_H
Horizontal Section	Period	T_H	1090	1100	1120	T_{CLK}
	Active	$T_{DISP}(H)$	960			T_{CLK}
	Blanking	$T_{BLK}(H)$	130	140	160	T_{CLK}
Clock	Period	T_{CLK}	14.677	13.41	11.958	ns
	Frequency	F_{CLK}	68.136	74.58	83.698	MHz
Vertical Frequency	Frequency	F_V	47	50	53	Hz
Horizontal Frequency	Frequency	F_H	62.51	67.8	74.73	KHz



3.4 Signal Timing Waveforms

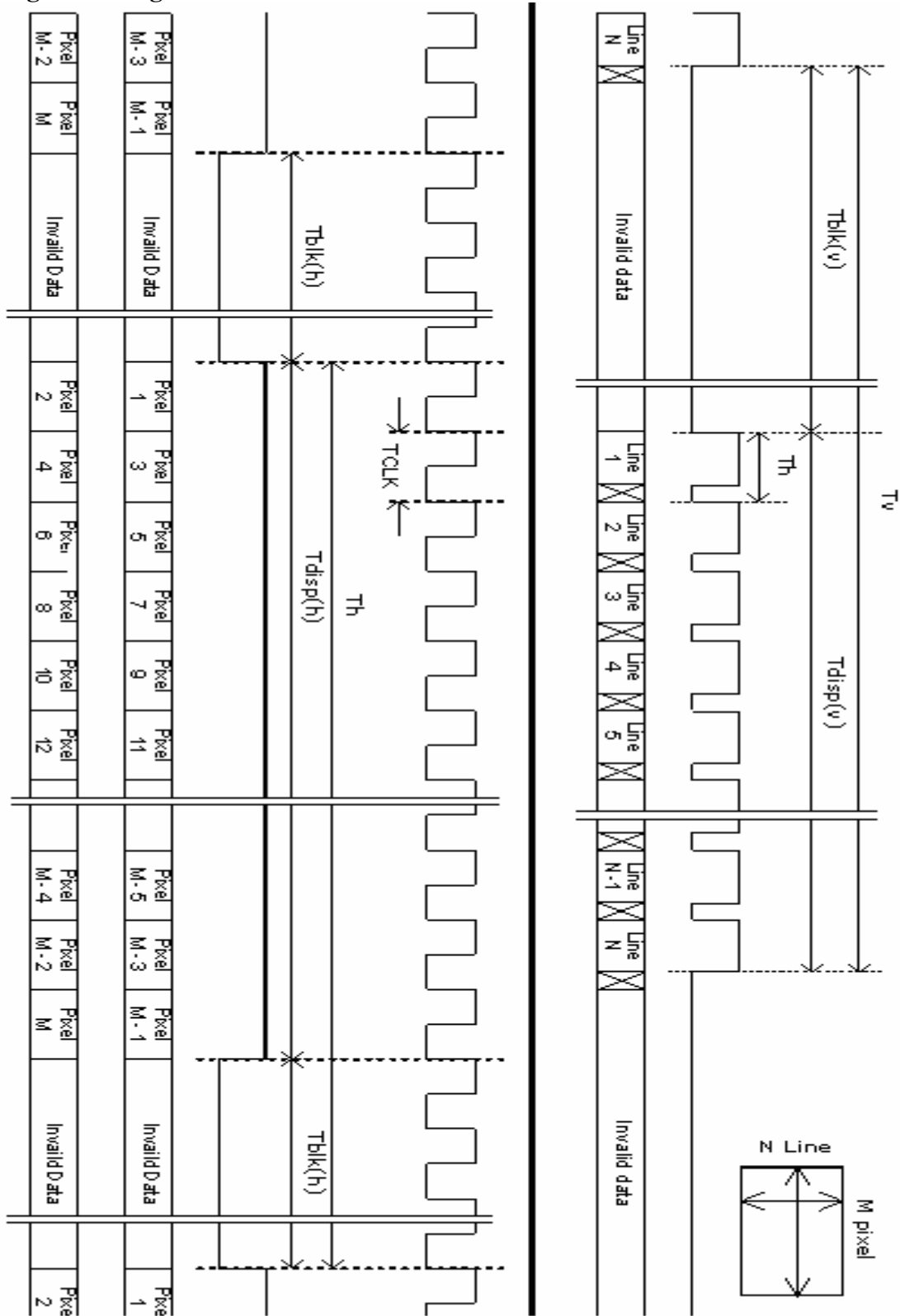



3.5 Color Input Data Reference

The brightness of each primary color (red, green and blue) is based on the 8 bit gray scale data input for the color; the higher the binary input, the brighter the color. The table below provides a reference for color versus data input.

COLOR DATA REFERENCE

Color		Input Color Data																							
		RED								GREEN								BLUE							
		MSB				LSB				MSB				LSB				MSB				LSB			
		R7	R6	R5	R4	R3	R2	R1	R0	G7	G6	G5	G4	G3	G2	G1	G0	B7	B6	B5	B4	B3	B2	B1	B0
Basic Color	Black	0	0	0	0	0	0	0	0	0	0	0	0	0	0	0	0	0	0	0	0	0	0	0	0
	Red(255)	1	1	1	1	1	1	1	1	0	0	0	0	0	0	0	0	0	0	0	0	0	0	0	0
	Green(255)	0	0	0	0	0	0	0	0	1	1	1	1	1	1	1	1	0	0	0	0	0	0	0	0
	Blue(255)	0	0	0	0	0	0	0	0	0	0	0	0	0	0	0	0	1	1	1	1	1	1	1	1
	Cyan	0	0	0	0	0	0	0	0	1	1	1	1	1	1	1	1	1	1	1	1	1	1	1	1
	Magenta	1	1	1	1	1	1	1	1	0	0	0	0	0	0	0	0	1	1	1	1	1	1	1	1
	Yellow	1	1	1	1	1	1	1	1	1	1	1	1	1	1	1	1	0	0	0	0	0	0	0	0
	White	1	1	1	1	1	1	1	1	1	1	1	1	1	1	1	1	1	1	1	1	1	1	1	1
RED	RED(000)	0	0	0	0	0	0	0	0	0	0	0	0	0	0	0	0	0	0	0	0	0	0	0	0
	RED(001)	0	0	0	0	0	0	0	1	0	0	0	0	0	0	0	0	0	0	0	0	0	0	0	0

	RED(254)	1	1	1	1	1	1	1	0	0	0	0	0	0	0	0	0	0	0	0	0	0	0	0	0
	RED(255)	1	1	1	1	1	1	1	1	0	0	0	0	0	0	0	0	0	0	0	0	0	0	0	0
GREEN	GREEN(000)	0	0	0	0	0	0	0	0	0	0	0	0	0	0	0	0	0	0	0	0	0	0	0	0
	GREEN(001)	0	0	0	0	0	0	0	0	0	0	0	0	0	0	0	1	0	0	0	0	0	0	0	0

	GREEN(254)	0	0	0	0	0	0	0	0	1	1	1	1	1	1	1	0	0	0	0	0	0	0	0	0
	GREEN(255)	0	0	0	0	0	0	0	0	1	1	1	1	1	1	1	1	0	0	0	0	0	0	0	0
BLUE	BLUE(000)	0	0	0	0	0	0	0	0	0	0	0	0	0	0	0	0	0	0	0	0	0	0	0	0
	BLUE(001)	0	0	0	0	0	0	0	0	0	0	0	0	0	0	0	0	0	0	0	0	0	0	0	1

	BLUE(254)	0	0	0	0	0	0	0	0	0	0	0	0	0	0	0	0	1	1	1	1	1	1	1	0
	BLUE(255)	0	0	0	0	0	0	0	0	0	0	0	0	0	0	0	0	1	1	1	1	1	1	1	1



3.6 Power Sequence

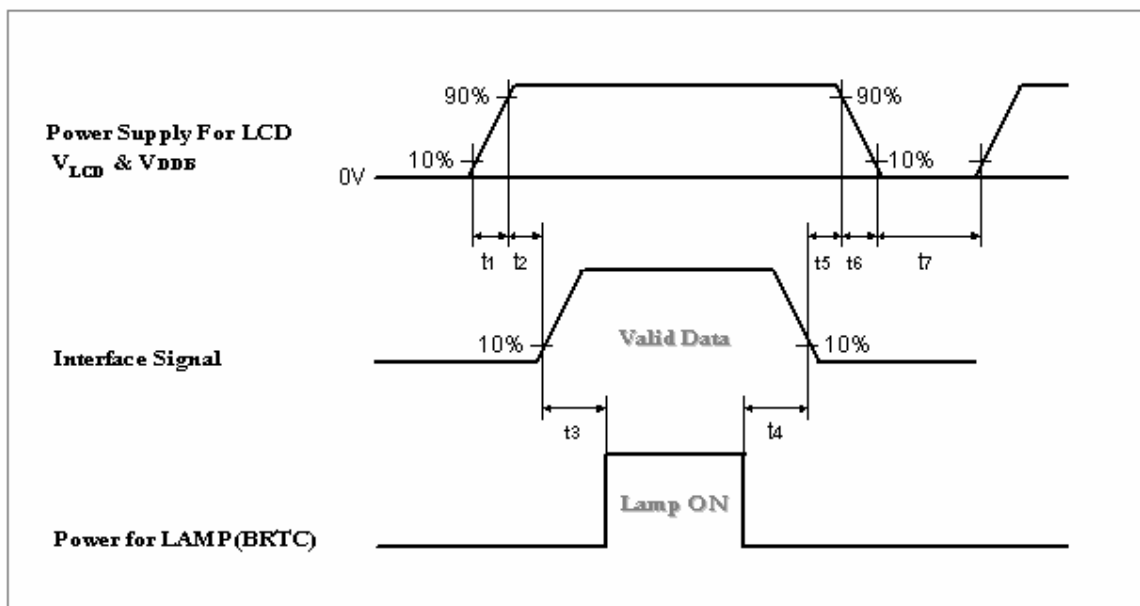

Parameter	Values			Unit
	Min.	Typ.	Max.	
t1	0.47	--	50	ms
t2	20	--	50	ms
t3	700 or (200)*	--	--	ms
t4	200	--	--	ms
t5	0.1	--	50	ms
t6	0.47	--	30	ms
t7	1000	--	--	ms

* If $t_3=200\text{ms}$, input black signal till 700ms from system is necessary. In case of $t_3<200\text{ms}$, the abnormal display will be happened. But it will not damage timing controller.

Apply the lamp voltage within the LCD operating range. When the backlight turns on before the LCD operation or the LCD turns off before the backlight turns off, the display may momentarily become abnormal.

Caution: The above on/off sequence should be applied to avoid abnormal function in the display. In case of handling, make sure to turn off the power when you plug the cable into the input connector or pull the cable out of the connector.



3.7 Backlight Power Specification

3.7.1 Characteristic of Back light Lamp

Ta=25±2 °C

Parameter	Symbol	Value			Units	Note
		Min	Typ.	Max		
Lamp Voltage	V _L	800	1000	1200		(I _L =8.5mA _{rms})
Life time	L _L	50000	60000			

3.7.2 Connector Pin Assignment

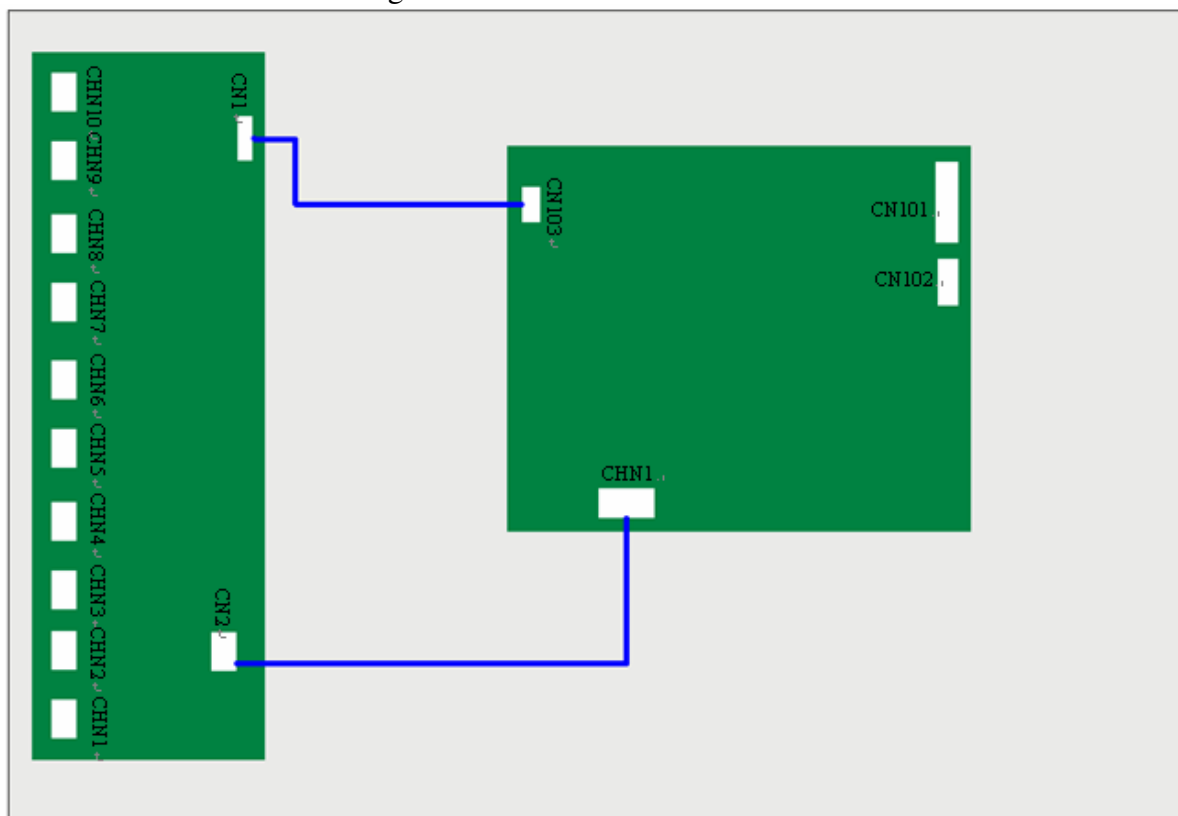

CN1: HIROSE_KN30-7P-1.25H

Pin NO	Name	Description
6,7	PROT	CCFL Connector Open & Non-lighting signal
4,5	GND	Signal Ground
2,3	IFB	Lamp Current Detected signal(Full wave current)
1	Vcc	Power supply for Protection Circuit

CN2: CON SMD 1R2P RT D13 H5.6 YEONHO

Pin NO	Name	Description
1	HV+	IP JIG high voltage supply
2	HV+	IP JIG high voltage supply



3.7.3 Specification

Item	Symbol	Description	Specification			Unit	Note
			Min.	Typ.	Max		
Supply Voltage	V _{CC}	DC input voltage	11.4	12	12.6	V _{DC}	
HV-Side Total Input Current	I _T	HV-Side input current when I _L =8.5mA	160	170	180	mA _{RMS}	(1)
Current Feedback Signal	V _{FB}	When I _T at 150mA by using IP JIG	2.1	2.3	2.5	V _{RMS}	
Lamp Frequency	f _L	Free run without sync.	44	46	48	KHz	
Output Working Voltage	V _{LAMP}	Lamp voltage of one lamp when I _H =8.5mA	--	1000	--	V _{RMS}	
PWM dimming duty ratio	DPWM	Duty control range by using IP JIG	20	--	100	%	
Lamp Striking Voltage	V _{STRIKE}	Lamp striking voltage at 25°C	1600	---	--	V _{RMS}	(2)
		Lamp striking voltage at 0°C	1900			V _{RMS}	(2)
Lamp Detection (OLP)	V _{LD}	Lamp normal status	11.4	12	12.6	V _{DC}	
		Lamp protection status	0	--	0.8	V _{DC}	
Output Current	I _{LMIN}	Output current of Min brightness for one lamp		8.2		mA _{RMS}	
	I _{LMAX}	Output current of Max brightness for one lamp	--	8.8	--	mA _{RMS}	

Note (1) Asymmetric ratio must less than 10 % ($|I_p - I_{-p}| / I_{rms@T} < 0.1$)
Crest factor must be from 90 % to 110 % ($0.9 < I_p / I_{rms@T/2 \times \sqrt{2}} < 1.1$)

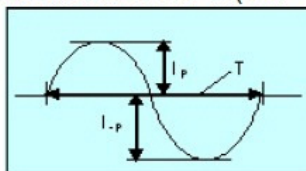

(2) Striking Voltage(HV_{STRIKE}) based on CCFL spec. for ambient temperature.

Soft rising time must be

- at starting time T_{soft} > 300msec

- at PWM dimming condition Trise < 100usec

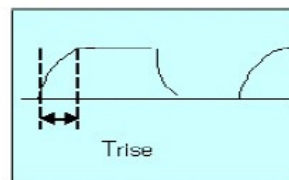
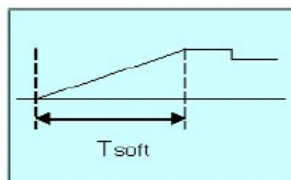



Optical Specification

Optical characteristics are determined after the unit has been 'ON' and stable for approximately 45 minutes in a dark environment at 25°C. The values specified are at an approximate distance 500mm from the LCD surface at a viewing angle of ϕ and θ equal to 0°.

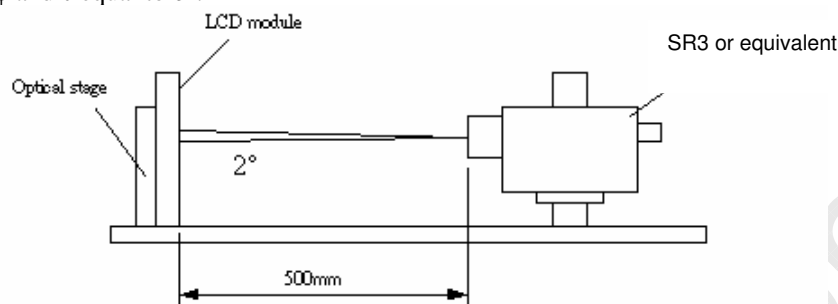

Fig.4-1 Optical measurement method

Parameter	Symbol	Values			Unit	Notes
		Min.	Typ.	Max		
Contrast Ratio	CR	2000	3000	--		1
Surface Luminance (White)	L_{WH}	400	500	--	cd/m ²	2
Luminance Variation	$\delta_{WHITE(OP)}$	--	--	1.3		3
Response Time (Average)	T_{γ}	--	8	--	Ms	4, 5 (Gray to Gray)
Rise Time	T_r	--	15	--	Ms	
Decay Time	T_f	--	5	--	Ms	
Color Coordinates						
Red	R_X	Typ.-0.03	0.635	Typ.+0.03		
	R_Y		0.338			
Green	G_X		0.280			
	G_Y		0.612			
Blue	B_X		0.147			
	B_Y		0.057			
White	W_X	0.280				
	W_Y	0.290				
Viewing Angle						(Contrast Ratio>10)
x axis, right($\phi=0^\circ$)	θ_r	--	89	--	degree	6
x axis, left($\phi=180^\circ$)	θ_l	--	89	--	degree	6
y axis, up($\phi=90^\circ$)	θ_u	--	89	--	degree	6
y axis, down ($\phi=270^\circ$)	θ_d	--	89	--	degree	6



Note:

1. Contrast Ratio (CR) is defined mathematically as:

$$\text{Contrast Ratio (CR)} = \frac{\text{Brightness of the "white" state}}{\text{Brightness of the "black" state}}$$

2. Surface Luminance is luminance value at point 5 across the LCD surface 50cm from the surface with all pixels displaying white. For more information see Fig. 4-2. When lamp current $I_H=8.5\text{mA}$, $L_{WH}=L_{on5}$, where L_{on5} is the luminance with all pixels displaying white at center 5 location.

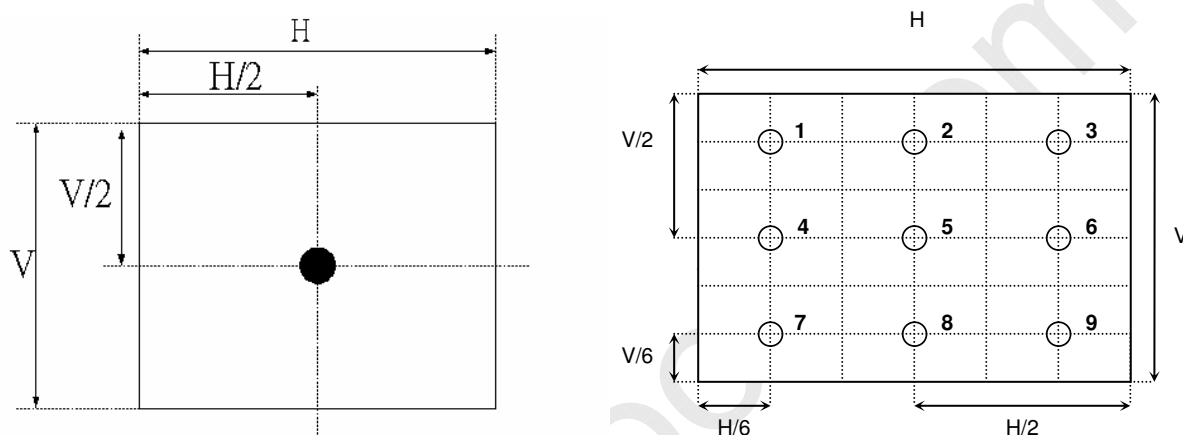

Fig.4-2 Optical measurement point

3. The variation in surface luminance, $\delta_{\text{WHITE(9P)}}$ is defined under brightness of $I_H=8.5\text{mA}$ as:

$$\delta_{\text{WHITE(9P)}} = \text{Maximum}(L_{on1}, L_{on2}, \dots, L_{on9}) / \text{Minimum}(L_{on1}, L_{on2}, \dots, L_{on9})$$

4. Response time is the time required for the display to transition from white(L255) to black(L0) (Decay Time, $T_f=Tr_D$), and from black(L0) to white(L255) (Rise Time, $T_r=Tr_R$). For additional information see Fig. 4-3.

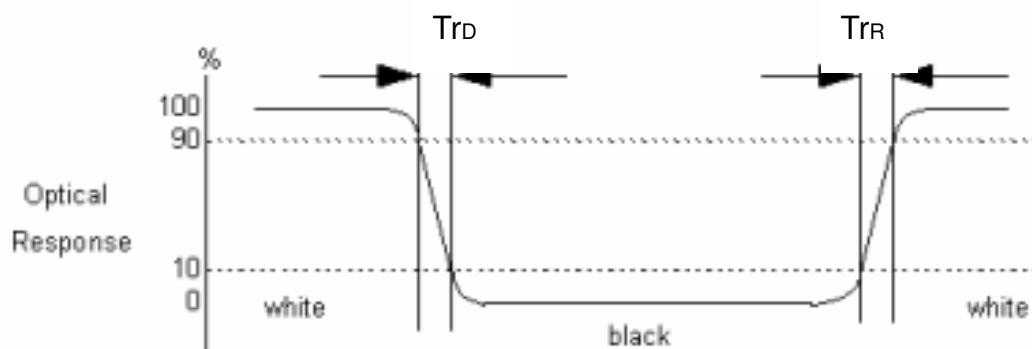

Fig.4-3 Response time



5. The response time is defined as the following figure and shall be measured by switching the input signal for 0, 63, 127, 191, 255 different gray level. For additional information see Fig. 4-4.

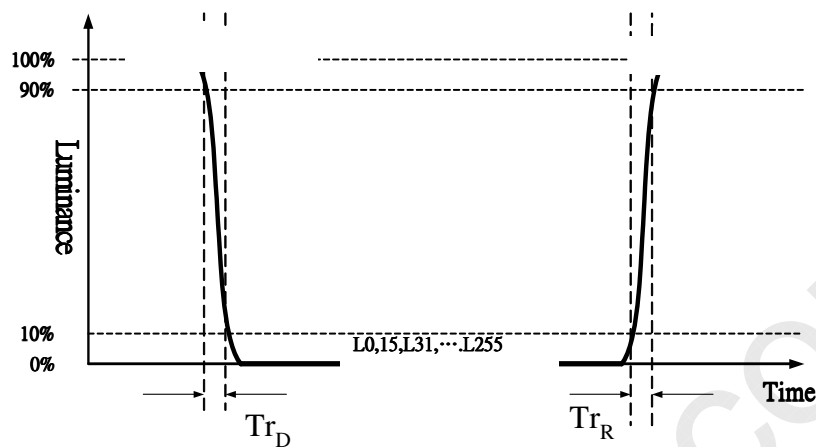

Fig.4-4 Response time

6. Viewing angle is the angle at which the contrast ratio is greater than 10. The angles are determined for the horizontal (or x-axis) and the vertical (or y-axis) with respect to the z-axis which is normal to the LCD surface. For more information see Fig. 4-5.

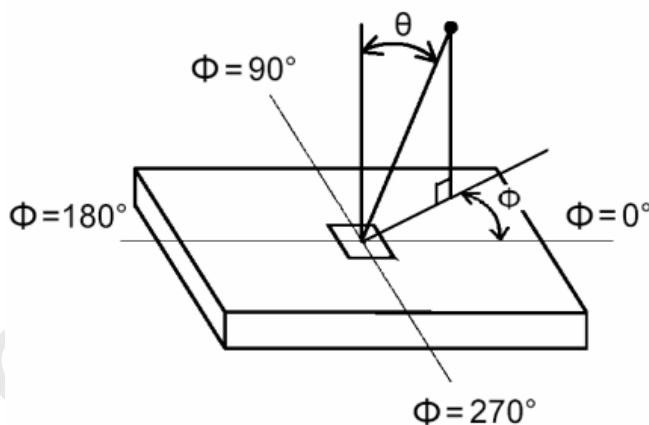

Fig.4-5 Viewing angle definition



4. Mechanical Characteristics

The contents provide general mechanical characteristics for the model T400HW01 V4. Detailed mechanical drawings are shown in the following pages.

Outline Dimension	Horizontal	952.0 mm
	Vertical	551.0 mm
	Depth	53.2 mm(to balance board cover)
Bezel Opening	Horizontal	891.7 mm
	Vertical	504.2 mm
Active Display Area	Horizontal	885.6mm
	Vertical	498.15 mm
Weight	11500g (Typ.)	



**Mechanical Figure:
Front view**

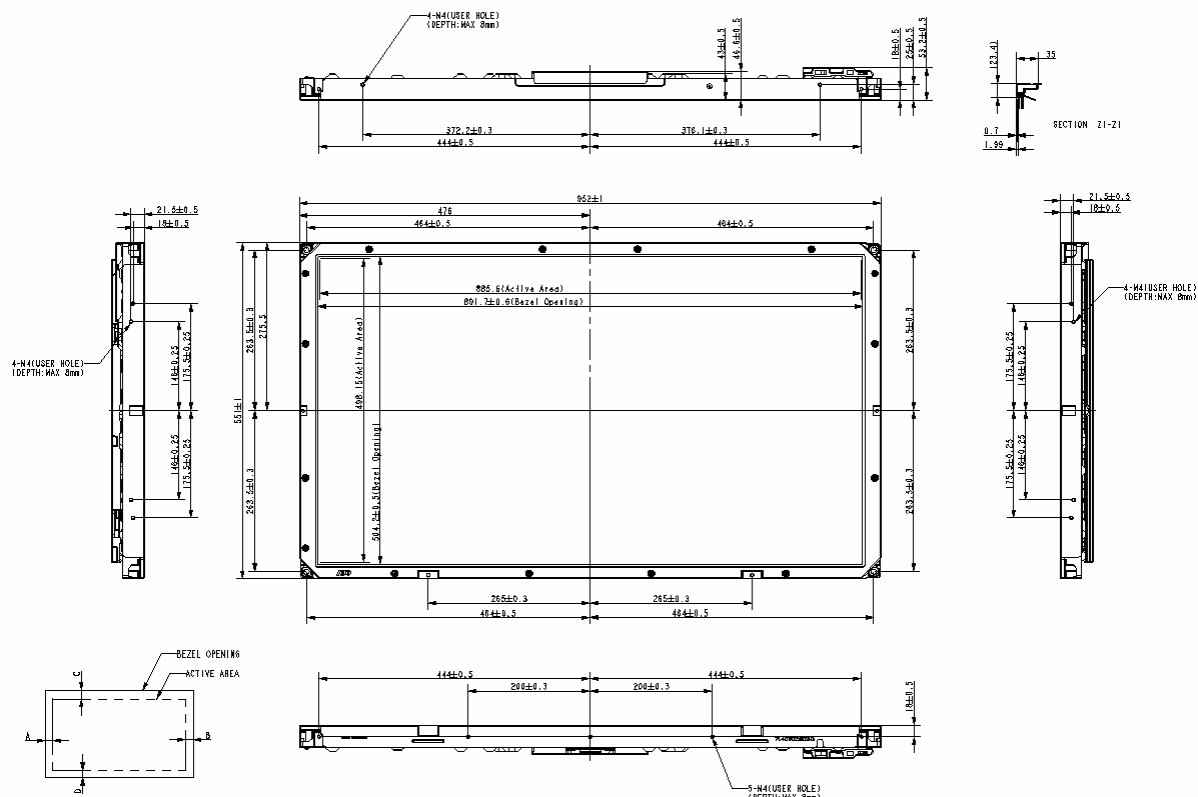

Rear view

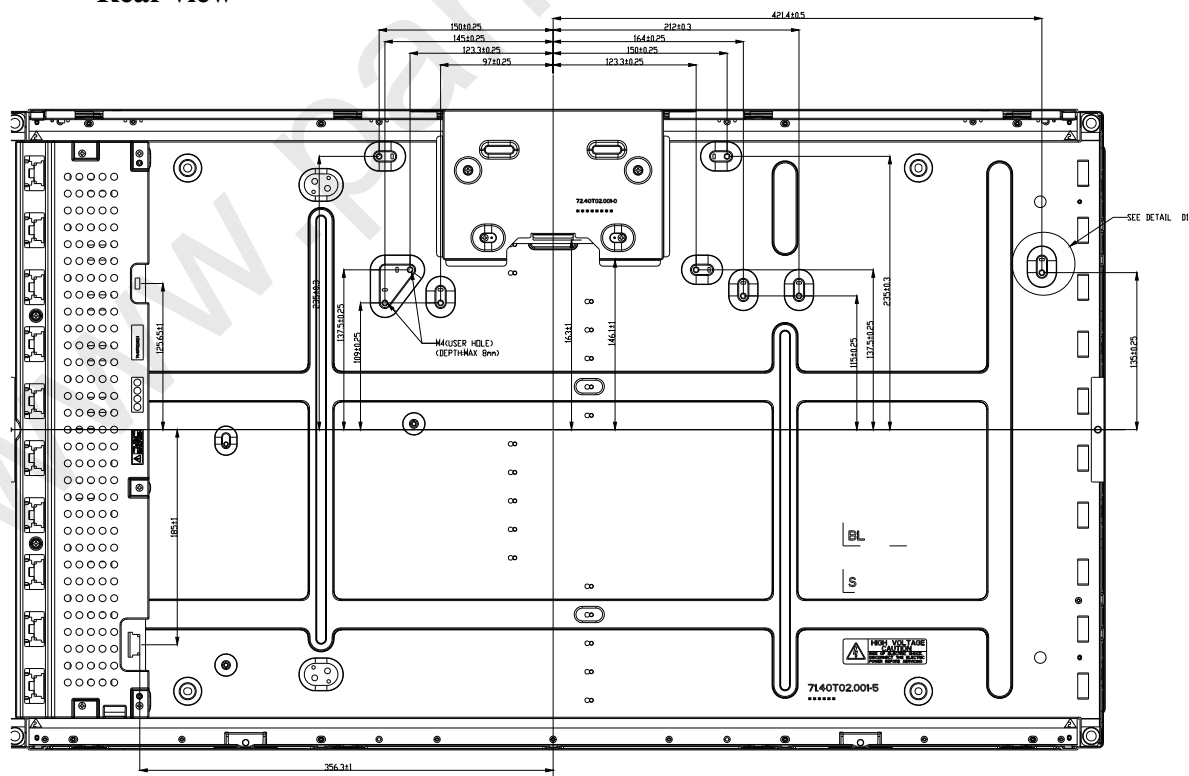

©Copyright AU Optronics Corp.
2007 All Rights Reserved.
No Reproduction and Redistribution Allowed

T400HW01 V4

21/28



6. Reliability Test Items

Environment test condition:

Panel condition in RA test

Brightness : 500nits

Lamp Current (Hot side) : 8.5mA

No	Test Item	Condition
1	High temperature storage test	Ta=60°C 240h
2	Low temperature storage test	Ta= -20°C 240h
3	High temperature operation test	Ta=50°C 80%RH 240h
4	Low temperature operation test	Ta=0°C 240h
5	Vibration test (non-operating)	Wave form: random Vibration level: 1.5G RMS Bandwidth: 10-300Hz, Duration: X, Y, Z 30min One time each direction
6	Shock test (non-operating)	Shock level: 50G Waveform: half sine wave, 11ms Direction: ±X, ±Y, ±Z One time each direction
7	Vibration test (with carton)	Wave form: random Vibration level: 2.19G RMS Bandwidth: 10-500Hz, Duration: X, Y, Z 30min One time each direction
8	Drop test (with carton)	Height: 45.7cm 1 corner, 3 edges, 6 surfaces (ASTMD 5276)



7. International Standard

7.1 Safety

- (1) UL1950 Third Edition, Underwriters Laboratories, Inc. Jan. 28, 1995
Standard for Safety of Information Technology Equipment Including electrical Business Equipment.
- (2) CAN/CSA C22.2 No. 950-95/60950 Third Edition, Canadian Standards Association,
Standard for Safety of Information Technology Equipment Including Electrical Business Equipment.
- (3) EN60950: 1992+A2: 1993+A2: 1993+C3: 1995+A4: 1997+A11: 1997
IEC 950: 1991+A1: 1992+A2: 1993+C3: 1995+A4:1996
European Committee for Electrotechnical Standardization (CENELEC)
EUROPEAN STANDARD for Safety of Information Technology Equipment Including Electrical Business Equipment.

7.2 EMC

- a) ANSI C63.4 “Methods of Measurement of Radio-Noise Emissions from Low-Voltage Electrical and Electrical Equipment in the Range of 9kHz to 40GHz. “American National standards Institute(ANSI), 1992
- b) C.I.S.P.R “Limits and Methods of Measurement of Radio Interface Characteristics of Information Technology Equipment.” International Special committee on Radio Interference.
- c) EN 55022 “Limits and Methods of Measurement of Radio Interface Characteristics of Information Technology Equipment.” European Committee for Electrotechnical Standardization. (CENELEC), 1998



8. Packing

8-1 DEFINITION OF LABEL:

A. Panel Label:



Green mark description

For Pb Free Product, AUO will add  for identification.

For RoHs compatible products, AUO will add  for identification.

Note: The green Mark will be present only when the green documents have been ready by AUO internal green team.
 (The definition of green design follows the AUO green design checklist.)

B. Carton Label:

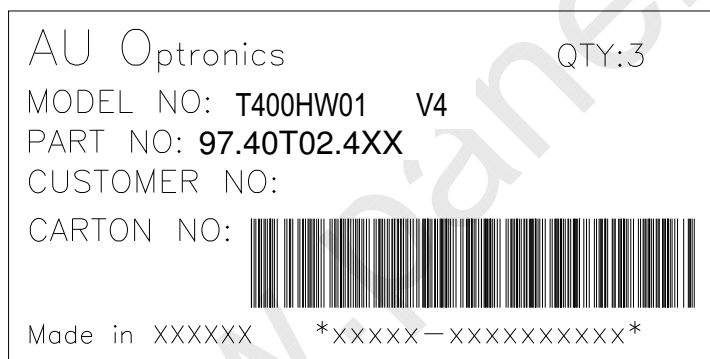



8-2 PACKING METHODS:

3pcs Modules

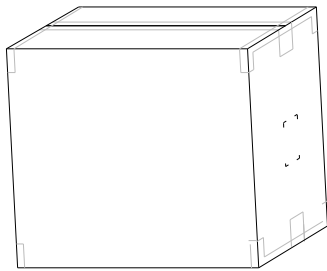
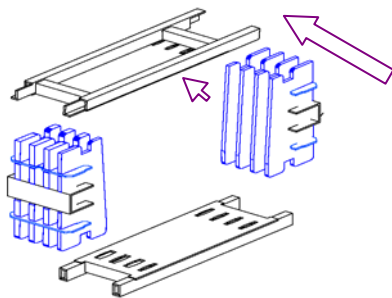

www.panelook.com



9. PRECAUTIONS

Please pay attention to the followings when you use this TFT LCD module.

9-1 MOUNTING PRECAUTIONS

- (1) You must mount a module using holes arranged in four corners or four sides.
- (2) You should consider the mounting structure so that uneven force (ex. Twisted stress) is not applied to module. And the case on which a module is mounted should have sufficient strength so that external force is not transmitted directly to the module.
- (3) Please attach the surface transparent protective plate to the surface in order to protect the polarizer. Transparent protective plate should have sufficient strength in order to resist external force.
- (4) You should adopt radiation structure to satisfy the temperature specification.
- (5) Acetic acid type and chlorine type materials for the cover case are not desirable because the former generates corrosive gas of attacking the polarizer at high temperature and the latter causes circuit break by electro-chemical reaction.
- (6) Do not touch, push or rub the exposed polarizer with glass, tweezers or anything harder than HB pencil lead. And please do not rub with dust clothes with chemical treatment. Do not touch the surface of polarizer for bare hand or greasy cloth. (Some cosmetics are detrimental to the polarizer.)
- (7) When the surface becomes dusty, please wipe gently with absorbent cotton or other soft materials like chamois soaks with petroleum benzene. Normal-hexane is recommended for cleaning the adhesives used to attach front/ rear polarizer. Do not use acetone, toluene and alcohol because they cause chemical damage to the polarizer.
- (8) Wipe off saliva or water drops as soon as possible. Their long time contact with polarizer causes deformations and color fading.
- (9) Do not open the case because inside circuits do not have sufficient strength.

9-2 OPERATING PRECAUTIONS

- (1) The spike noise causes the mis-operation of circuits. It should be lower than following voltage:
 $V = \pm 200\text{mV}$ (Over and under shoot voltage)
- (2) Response time depends on the temperature. (In lower temperature, it becomes longer.)
- (3) Brightness of CCFL depends on the temperature. (In lower temperature, it becomes lower.) And in lower temperature, response time (required time that brightness is stable after turned on) becomes longer.
- (4) Be careful for condensation at sudden temperature change. Condensation makes damage to polarizer or electrical contacted parts. And after fading condensation, smear or spot will occur.
- (5) When fixed patterns are displayed for a long time, remnant image is likely to occur.
- (6) Module has high frequency circuits. Sufficient suppression to the electromagnetic interference shall be done by system manufacturers. Grounding and shielding methods may be important to minimize the interface.



9-3 ELECTROSTATIC DISCHARGE CONTROL

Since a module is composed of electronic circuits, it is not strong to electrostatic discharge. Make certain that treatment persons are connected to ground through wristband etc. And don't touch interface pin directly.

9-4 PRECAUTIONS FOR STRONG LIGHT EXPOSURE

Strong light exposure causes degradation of polarizer and color filter.

9-5 STORAGE

When storing modules as spares for a long time, the following precautions are necessary.

- (1) Store them in a dark place. Do not expose the module to sunlight or fluorescent light. Keep the temperature between 5°C and 35°C at normal humidity.
- (2) The polarizer surface should not come in contact with any other object. It is recommended that they be stored in the container in which they were shipped.

9-6 HANDLING PRECAUTIONS FOR PROTECTION FILM

- (1) The protection film is attached to the bezel with a small masking tape. When the protection film is peeled off, static electricity is generated between the film and polarizer. This should be peeled off slowly and carefully by people who are electrically grounded and with well ion-blown equipment or in such a condition, etc.
- (2) When the module with protection film attached is stored for a long time, sometimes there remains a very small amount of glue still on the Bezel after the protection film is peeled off.
- (3) You can remove the glue easily. When the glue remains on the Bezel or its vestige is recognized, please wipe them off with absorbent cotton waste or other soft material like chamois soaked with normal-hexane.