

# **Data Sheets of AVA Technology SMD Type White LED**

**Model : T5050**

**AVA Technology Co.**

**2640 S. Myrtle Ave. Suite 6**

**Monrovia, CA 91016**

**P: 626-574-7726**

**F: 626-574-7732**

**<http://www.led4life.com>**

### Top View LED with Reflector

#### 1. FEATURES

- High intensity with small package, ideal for backlighting
- Wide viewing angle ( 120° )
- Package Outline (L×W×H)=5.0×5.0×1.5 mm
- Technology : InGaN
- Color coordinates CIE(x,y) : (0.31,0.31) according to CIE 1931.
- Suitable for all SMT assembly methods
- Suitable for all soldering methods
- Delivery on 12mm tape reels

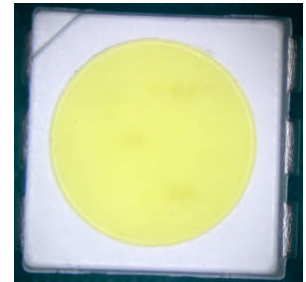

#### 2. APPLICATIONS

- Automotive: indoor/outdoor lighting.
- Signal and symbol lightings
- Backlighting (Large LCD.....)
- All applications in notice high intensities are required
- Strobe Light
- Channel Letter
- Decorative Light

#### 3. DEVICES PACKAGE

ITEM	MATERIALS
Package	Heat-Resistant Polymer
Encapsulating	Heat Resistance Resin
Electrodes	Ag Plating Copper Alloy

Type	Color of Emission	Color of the Light Emitting Area	Luminous intensity I <sub>v</sub> (mcd) I <sub>F</sub> =20mA
T5050	White	Colored	3000 ~ 6000

## 4. OUTLINE DIMENSION:

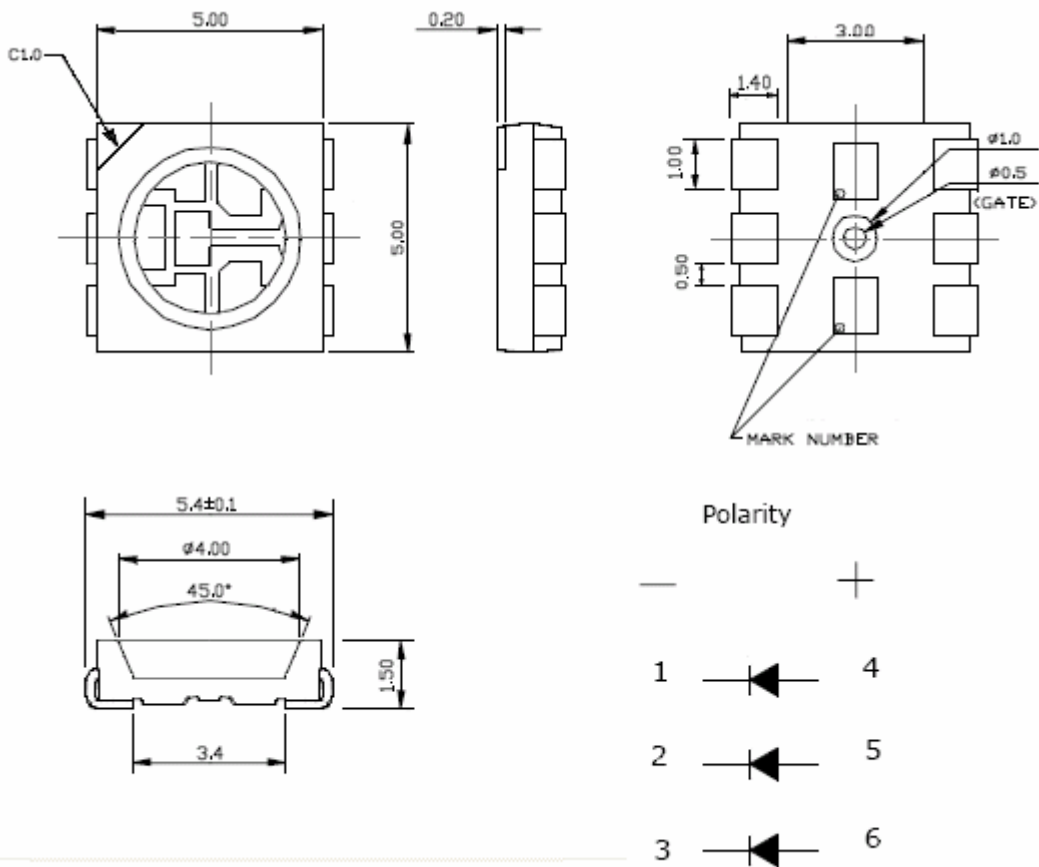

Note:

1. Unit: mm

2. Tolerance: Dimension ± 0.1 / Angle ± 0.5°

## 5. ABSOLUTE MAXIMUM RATINGS ( $T_A=25^\circ\text{C}$ )

Parameter	Symbol	Absolute Max. Rating	Unit
Reverse Voltage	$V_R$	5	V
Forward Current	$I_F$	40	mA
Operating Temperature	$T_{opr}$	-30 ~ +85	$^\circ\text{C}$
Storage Temperature	$T_{stg}$	-40 ~ +100	$^\circ\text{C}$
Soldering Temperature	$T_{sol}$	260 (for 5 sec)	$^\circ\text{C}$
Power Dissipation	$P_D$	432 (3 chips ON)	mW
Peak Forward Current (Duty 1/10 @ 1KHz)	$I_{F(peak)}$	240 (3 chips ON)	mA
Junction temperature	$T_j$	110	$^\circ\text{C}$
Thermal Resistance (Junction to ambient)	$R_{th, JA}$	450	$^\circ\text{C}/\text{W}$

## 6. ELECTRONIC OPTICAL CHARACTERISTICS

Parameter	Symbol	Condition	Min.	Typ.	Max.	Unit
Chromaticity coordinate x acc. To CIE 1931	x	$I_F=20/20/20\text{mA}$	---	0.31	---	---
Chromaticity coordinate y acc. To CIE 1931	y	$I_F=20/20/20\text{mA}$	---	0.31	---	---
Viewing Angle	$2\theta_{1/2}$	$I_F=20/20/20\text{mA}$	---	120	---	Deg
Forward Voltage	$V_F$	$I_F=20/20/20\text{mA}$	---	3.30	3.60	V
Leakage Current	$I_R$	$V_R= -5\text{V}$	---	---	50	$\mu\text{A}$

### 7. LUMINOUS INTENSITY GROUPS:

Luminous intensity group	Measurement condition	Luminous intensity Iv(mcd)
W5	I <sub>F</sub> = 20/20/20 mA	5000-6000
W4		4250-5000
W3		3600-4250
W2		3000-3600

www.DataSheet4U.com

- \* Luminous intensity group includes 4 groups W2 to W5.
- \* Luminous intensity is tested at a current pulse duration of 25ms and a tolerance of  $\pm 10\%$

## 8. CHROMATICITY COORDINATES RANKS :

Forward Current, IF=20mA											
Rank	CIE		Rank	CIE		Rank	CIE		Rank	CIE	
	x	y		x	y		x	y		x	y
a31	0.2650	0.2670	b74 (b52)	0.2900	0.2885	b63	0.3190	0.3180	b43	0.3177	0.3350
	0.2690	0.2625		0.2950	0.2785		0.3200	0.3050		0.3185	0.3270
	0.2790	0.2760		0.3060	0.2875		0.3300	0.3170		0.3300	0.3390
	0.2760	0.2810		0.3020	0.3000		0.3300	0.3300		0.3300	0.3490
a32	0.2690	0.2625	b82	0.3060	0.2875	b64	0.3185	0.3270	b44	0.3172	0.3452
	0.2770	0.2535		0.3080	0.2790		0.3190	0.3180		0.3177	0.3350
	0.2850	0.2665		0.3130	0.2850		0.3300	0.3300		0.3300	0.3490
	0.2790	0.2760		0.3110	0.2940		0.3300	0.3390		0.3300	0.3600
a33 (b71)	0.2790	0.2760	b83	0.3110	0.2940	b31	0.2830	0.3070	d1	0.3300	0.3600
	0.2850	0.2665		0.3130	0.2850		0.2853	0.3000		0.3300	0.3390
	0.2950	0.2785		0.3210	0.2940		0.2980	0.3150		0.3400	0.3390
	0.2900	0.2885		0.3200	0.3050		0.2960	0.3210		0.3400	0.3600
a34	0.2760	0.2810	b84 (b62)	0.3085	0.3075	b32	0.2853	0.3000	d2	0.3300	0.3390
	0.2790	0.2760		0.3110	0.2940		0.2870	0.2950		0.3300	0.3170
	0.2900	0.2885		0.3200	0.3050		0.3000	0.3080		0.3400	0.3170
	0.2870	0.2950		0.3190	0.3180		0.2980	0.3150		0.3400	0.3390
a36	0.2770	0.2535	b51	0.2870	0.2950	b33	0.2980	0.3150	d3	0.3400	0.3390
	0.2840	0.2460		0.2900	0.2885		0.3000	0.3080		0.3400	0.3170
	0.2910	0.2570		0.3020	0.3000		0.3070	0.3150		0.3500	0.3170
	0.2850	0.2665		0.3000	0.3080		0.3055	0.3220		0.3500	0.3390
e00	0.2470	0.2370	b53 (b81)	0.3020	0.3000	b34	0.2960	0.3210	d4	0.3400	0.3600
	0.2670	0.2190		0.3060	0.2875		0.2980	0.3150		0.3400	0.3390
	0.2810	0.2490		0.3110	0.2940		0.3055	0.3220		0.3500	0.3390
	0.2650	0.2670		0.3085	0.3075		0.3040	0.3300		0.3500	0.3600
b72	0.2850	0.2665	b54	0.3000	0.3080	b41	0.3040	0.3300			
	0.2910	0.2570		0.3020	0.3000		0.3055	0.3220			
	0.3000	0.2690		0.3085	0.3075		0.3177	0.3350			
	0.2950	0.2785		0.3070	0.3150		0.3172	0.3452			
b73	0.2950	0.2785	b61	0.3070	0.3150	b42	0.3055	0.3220			
	0.3000	0.2690		0.3085	0.3075		0.3070	0.3150			
	0.3080	0.2790		0.3190	0.3180		0.3185	0.3270			
	0.3060	0.2875		0.3185	0.3270		0.3177	0.3350			

\* CIE rank can be sorted by 0.008~0.015

\* Tolerance of the chromaticity coordinate is  $\pm 0.007$

## 9. TYPICAL ELECTRO-OPTICAL CHARACTERISTIC CURVES:

\* Chromaticity Coordinates (CIE 1931 system)

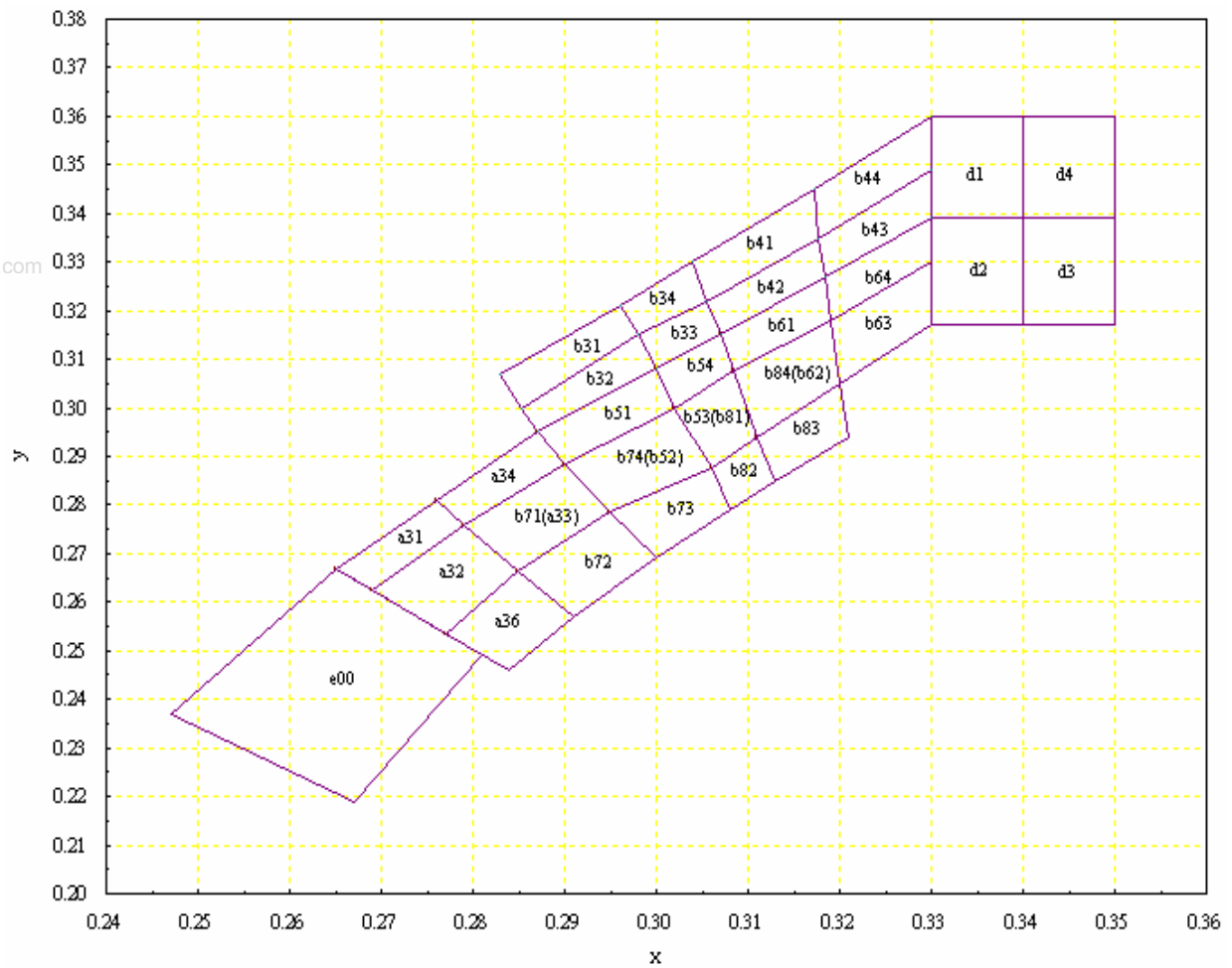

**\* Forward Voltage vs. Forward Current @25°C**

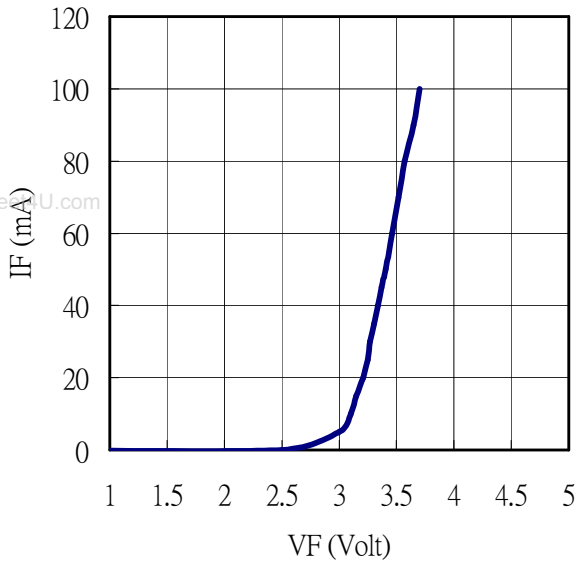

**Forward Current vs. Relative Luminosity @25°C**

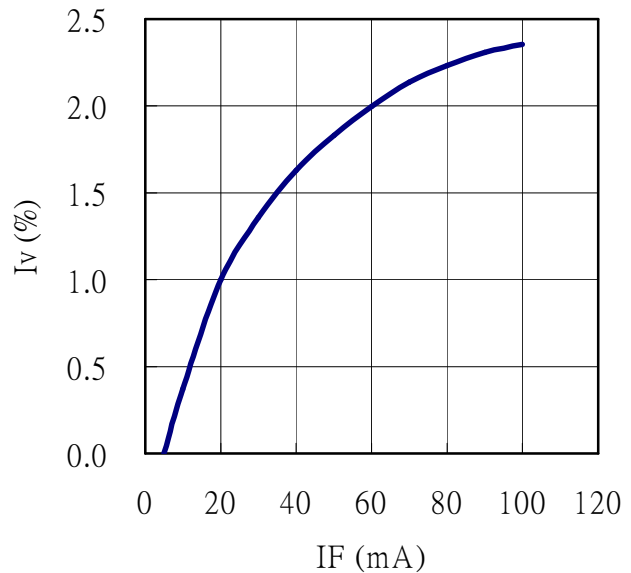

**\* Ambient Temperature vs. Allowable Forward Current**

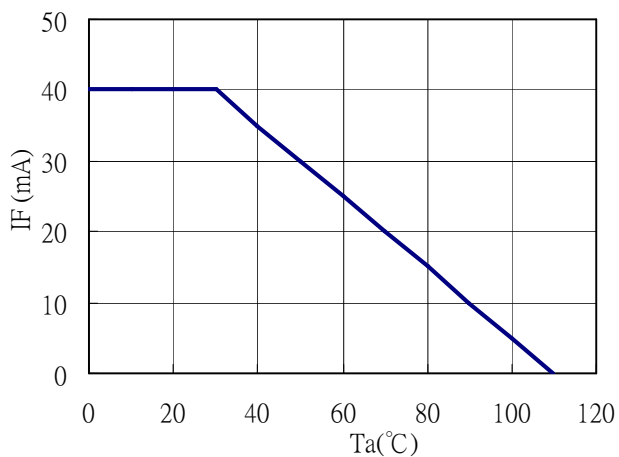

**\* Ambient Temperature vs. Forward Voltage @20mA**

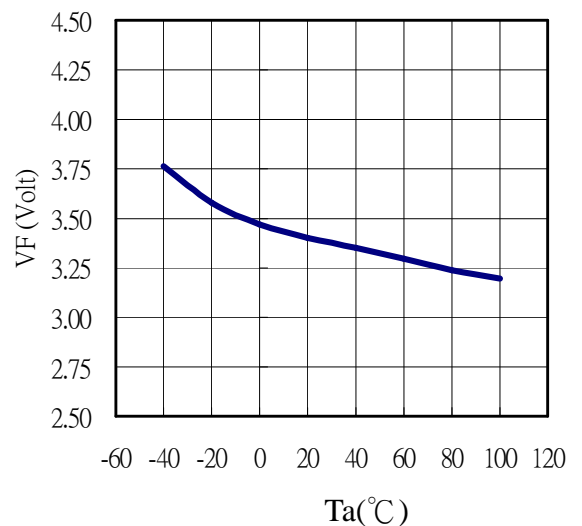



**\* Forward Current vs. Chromaticity diagram @ 25°C**

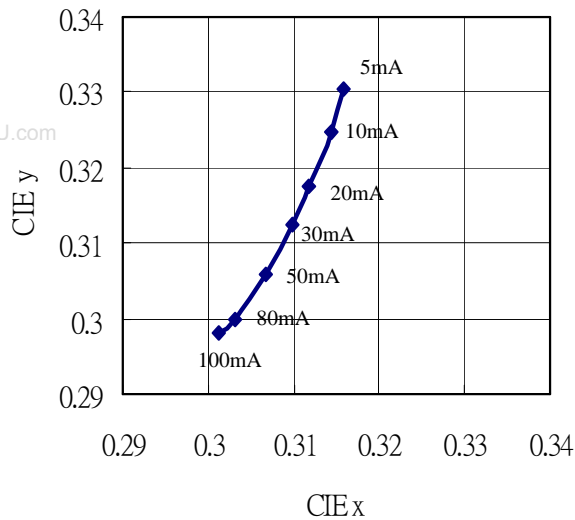

**\* Spectrum @ 20mA, 25°C**

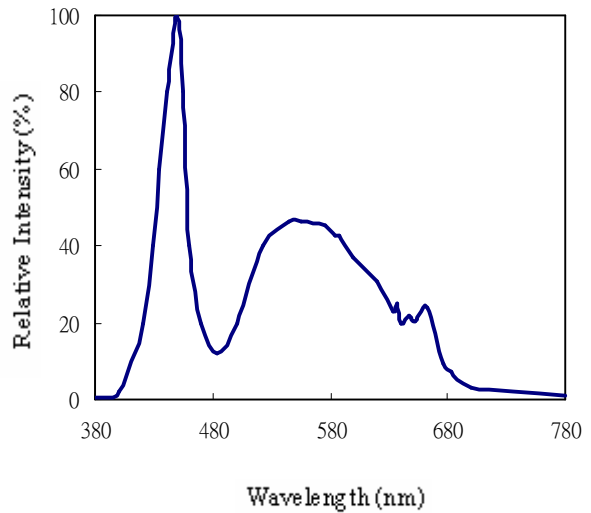

**\* Ambient Temperature vs. Chromaticity Diagram @ 20mA**

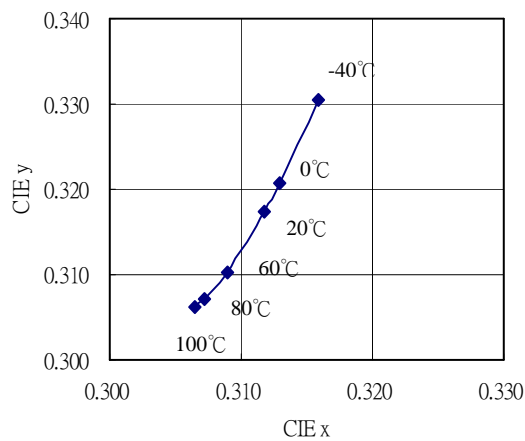

**\* Radiation Characteristic (@ 25°C, 20mA)**

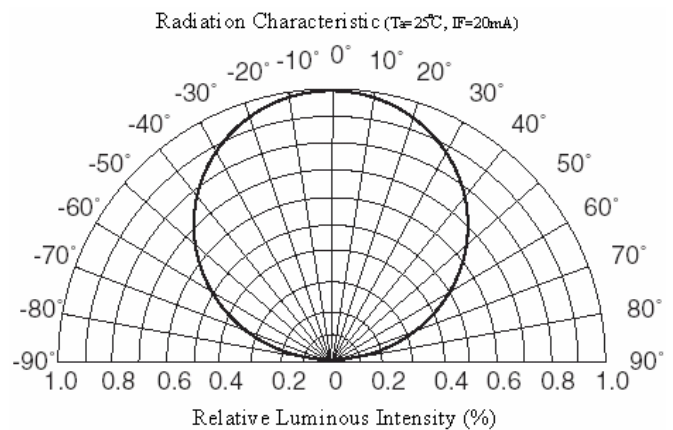

## 10. REEL PACKAGE:

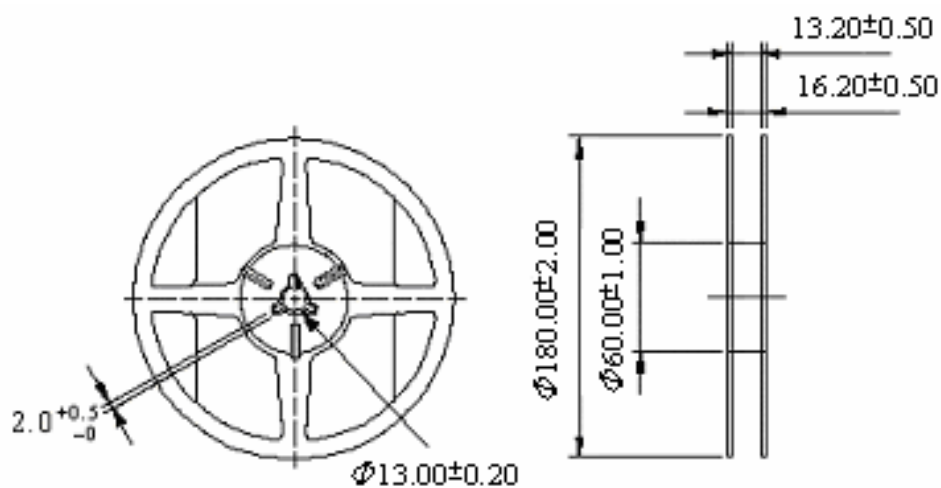
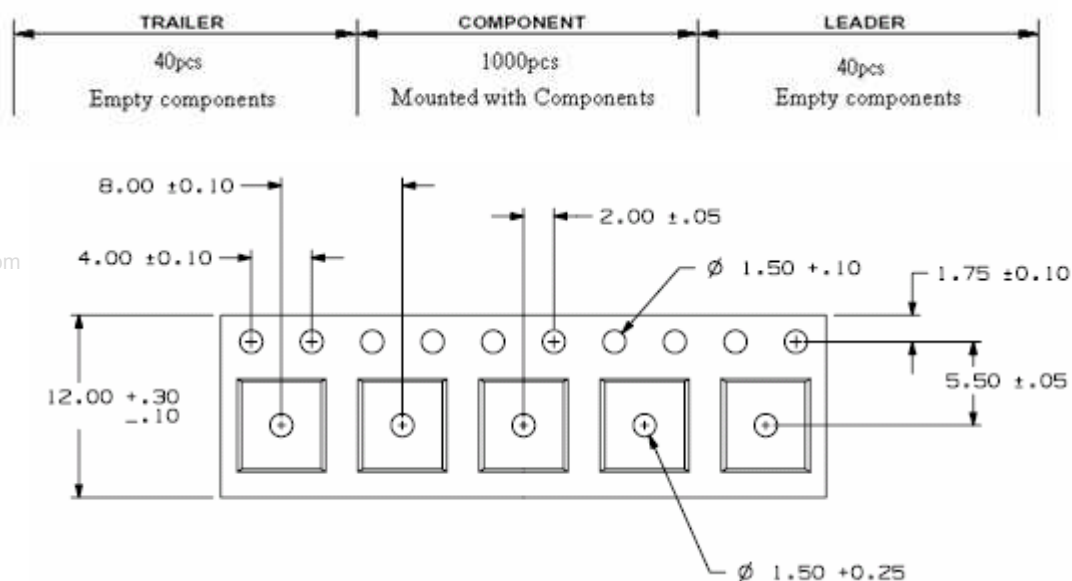

Note:  
 1. Unit: mm  
 2. 1,000 pcs / reel

### 11. RELIABILITY PLAN:

\* The reliability of products shall be satisfied with items listed below.

Confidence Level : 90 % , LTPD : 10 %

No	Test Item	Description & Condition		Sample size	Ac/Re	Failure Criteria
1	Solderability	T <sub>sld</sub> = 235±5°C, 10sec,	1 time	22	0/1	IV < L * 0.6 (I <sub>F</sub> : 20mA)  V <sub>F</sub> > U * 1.1 (I <sub>F</sub> : 20mA)  I <sub>R</sub> > U * 2.0 (V <sub>R</sub> : 5V)  L: Lower Spec. Level  U: Upper Spec. Level
2	Room Temperature operating	T <sub>a</sub> = 25 °C I <sub>F</sub> = 60mA	1000 hrs	22	0/1	
3	Room Temperature operating	T <sub>a</sub> = 25 °C I <sub>F</sub> = 90mA	500 hrs	22	0/1	
4	Low Temperature Storage	T <sub>a</sub> = -40 °C	1000 hrs	22	0/1	
5	High Temperature Storage	T <sub>a</sub> = 100 °C	1000 hrs	22	0/1	
6	Temperature Cycle	-40°C ~ 25°C ~ 100°C ~ 25 °C 30min 5min 30min 5 min	100 cycles	22	0/1	
7	High Humidity Heat	T <sub>a</sub> = 60 °C RH=90% I <sub>F</sub> = 45mA	500 hrs	22	0/1	

## 12. SOLDERING CONDITIONS:

### (1) Recommended Re-flow profile

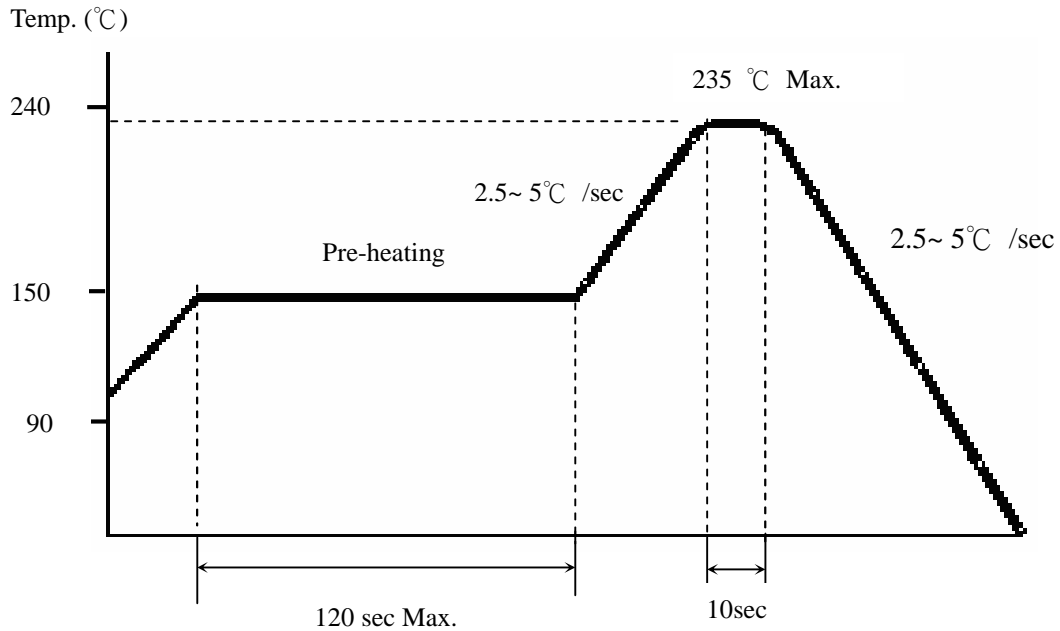

### Recommended Soldering Pad

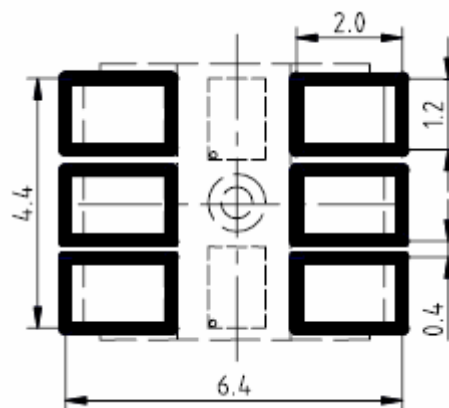

(Unit : mm)

- (2) Re-flow soldering should not be done more than two times.
- (3) It is recommended that the user use the nitrogen reflow method.
- (4) When soldering, don't put stress on the LEDs during heating.
- (5) After soldering, don't warp the circuit board.
- (6) It is recommended that isopropyl alcohol (IPA) be used as a solvent for cleaning the LEDs.

## 13. CAUTIONS:

### (1) Storage

- Before opening the package :

The LEDs should be kept at 30°C or less and 30%RH~85%RH. The LEDs should be used within a year. When storing the LEDs, moisture proof packaging with desiccant (Silica gel) is recommended.

- After opening the package :

The LEDs should be kept at 30°C or less and 30%RH~70%RH. The LEDs should be soldered within 168 hours (7 days) after opening the package. If unused LEDs remain, they should be stored in moisture proof packages, such as sealed containers with packages of moisture desiccant (Silica gel), or reseal the moisture proof bag again.

If the moisture desiccant (Silica gel) has faded away or the LEDs have exceeded the storage time, baking treatment should be performed using the following conditions.

Baking treatment: more than 24 hours at 65°C.

Please avoid conditions which may cause the LED to corrode, tarnish or discolor. This corrosion or discoloration might lower solderability or might effect on optical characteristics. -Please avoid rapid transitions in ambient temperature, especially in high humidity environments where condensation can occur.

- Moisture Proof package

When moisture is absorbed into the SMT package it may vaporize and expand during soldering. There is a possibility that this can cause exfoliation of the contacts and damage to the optical characteristics of the LEDs. For this reason, the moisture proof package is used to keep moisture to a minimum in the package. A package of a moisture desiccant (silica gel) is inserted into the moisture proof bag - The silica gel changes its color from blue to pink as it absorbs moisture.

### (2) Static Electricity

- Static electricity or surge voltage damages the LEDs. It is recommended that a wrist band or an anti-electrostatic glove and shoe be used when handling the LEDs.
- All devices, equipment and machinery must be properly grounded. It is recommended that measures be taken against surge voltage to the equipment that mounts the LEDs.
- when inspecting the final products in which LEDs were assembled, it is recommended to check whether the assembled LEDs are damaged by static electricity or not. It is easy to End static-damaged LEDs by a light-on test or a  $V_F$  test at a lower current (below 1 mA).
- Damaged LEDs will show some unusual characteristics such as the leak current remarkably increases, the forward voltage becomes lower, or the LEDs do not light at the low current. (Criteria :  $V_F > 2.0V$  at  $I_F = 0.5mA$ .)

### (3) Heat Generation

- Please consider the heat generation of the LED when making the system design that it's very importance. The coefficient of temperature increase per input electric power is effected by the thermal resistance of the circuit board and density of LED placement on the board, and other components. It is necessary to avoid intense heat generation and operate within the maximum ratings given in this specification.
- The operating current should be decided after considering the ambient maximum temperature of LEDs

#### (4)Others

- Care must be taken to ensure that the reverse voltage will not exceed the absolute maximum rating when using the LEDs with matrix drive.
- The LED light output is strong enough to injure human eyes. Precautions must be taken to prevent looking directly for more than a few seconds. Flashing lights have been known to cause discomfort in people; you can prevent this by taking precautions during use. Also, people should be cautious when using equipment that has had LEDs incorporated into it.

## Copyright, Trademarks and Patents

*AVA TECHNOLOGY CO. MAKES NO WARRANTY, REPRESENTATION OF GUARANTEE, EXPRESS OR IMPLIED, REGARDING THE SUITABILITY OF ITS PRODUCTS FOR ANY PARTICULAR PURPOSE, NOR THAT THE USE OR APPLICATION AND SPECIFICALLY DISCLAIMS ANY AND ALL LIABILITY ARISING OUT OF ANY SUCH USE OR APPLICATION, INCLUDING BUT NOT LIMITED TO, CONSEQUENTIAL OR INCIDENTAL DAMAGES.*

AVA Technology Co. are not designed, intended or authorized for use as components in systems intended for surgical implant into the body, or other applications intended to support or sustain life, or for any other application in which the failure of the AVA Technology Co. Product could create a situation where personal injury or death may occur.

AVA Technology Co. reserves the right to make changes to or discontinue any product or service described herein without notice.

**AVA Technology Co.**

**World Wide Web**

<http://www.led4life.com>