

OCTAL TRANSPARENT LATCH WITH 3-STATE OUTPUTS

DESCRIPTION

The T54LS373/T74LS373 consists of eight latches with 3-state outputs for bus organized system applications. The flip-flops appear transparent to the data (data changes asynchronously) when Latch Enable (LE) is HIGH. When LE is LOW, the data that meets the set-up times is latched. Data appears on the bus when the Output Enable (\overline{OE}) is LOW. When \overline{OE} is HIGH the bus outputs is in the high impedance state.

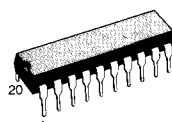

B1
Plastic Package

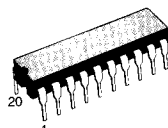

D1/D2
Ceramic Package



M1
Micro Package



C1
Plastic Chip Carrier

ORDERING NUMBERS:

T54LS373 D2 T74LS373 C1
T74LS373 D1 T74LS373 M1
T74LS373 B1

- EIGHT LATCHES IN A SINGLE PACKAGE
- 3-STATE OUTPUTS FOR BUS INTERFACING
- HYSTERESIS ON LATCH ENABLE
- INPUT CLAMP DIODES LIMIT HIGH SPEED TERMINATION EFFECTS
- FULLY TTL AND CMOS COMPATIBLE

PIN NAMES

D ₀ -D ₇	Data Inputs
LE	Latch Enable (Active HIGH) Input
\overline{OE}	Output Enable (Active LOW) Input
O ₀ -O ₇	Outputs

PIN CONNECTION (top view)

DUAL IN LINE

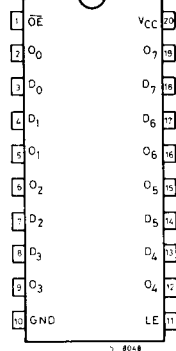

CHIP CARRIER

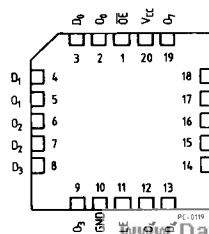

NC = No Internal Connection



LOGIC SYMBOL AND LOGIC DIAGRAM

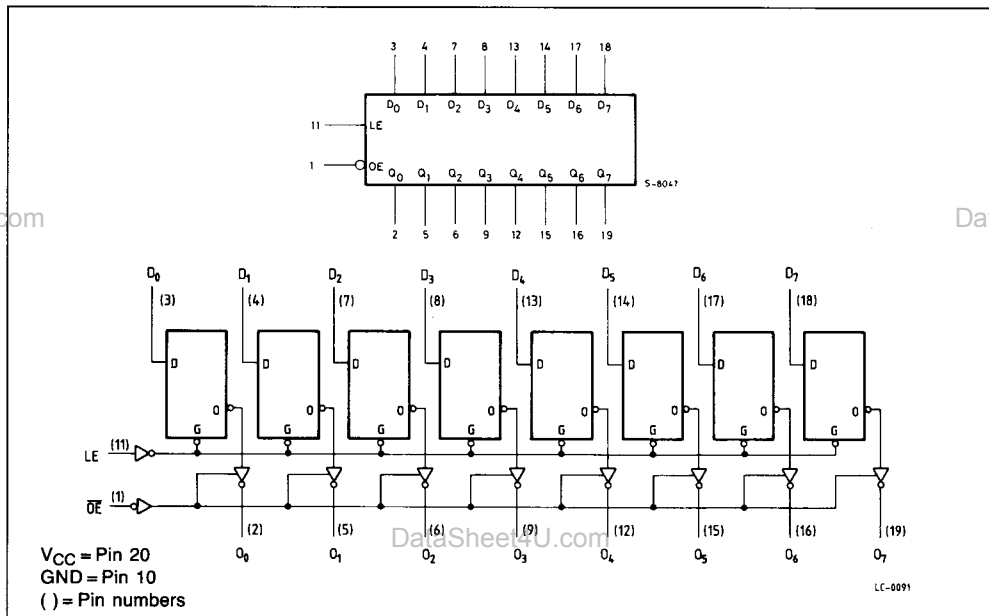

ABSOLUTE MAXIMUM RATINGS

Symbol	Parameter	Value	Unit
V_{CC}	Supply Voltage	-0.5 to 7	V
V_I	Input Voltage, Applied to Input	-0.5 to 15	V
V_O	Output Voltage, Applied to Output	-0.5 to 10	V
I_I	Input Current, Into Inputs	-30 to 5	mA
I_O	Output Current, Into Outputs	50	mA

Stresses in excess of those listed under "Absolute Maximum Ratings" may cause permanent damage to the device. This is a stress rating only and functional operation of the device at these or any other conditions in excess of those indicated in the operational sections of this specification is not implied. Exposure to absolute maximum rating conditions for extended periods may affect device reliability.

GUARANTEED OPERATING RANGES

Part Numbers	Supply Voltage			Temperature
	Min	Typ	Max	
T54LS373D2	4.5 V	5.0 V	5.5 V	-55°C to +125°C
T74LS373XX	4.75 V	5.0 V	5.25 V	0°C to +70°C

XX = package type.



DC CHARACTERISTICS OVER OPERATING TEMPERATURE RANGE

Symbol	Parameter		Limits			Test Conditions (Note 1)	Units	
			Min.	Typ.	Max.			
V _{IH}	Input HIGH Voltage		2.0			Guaranteed input HIGH Voltage for all Inputs	V	
V _{IL}	Input LOW Voltage	54			0.7	Guaranteed input LOW Voltage for all Inputs	V	
		74			0.8			
V _{CD}	Input Clamp Diode Voltage			-0.65	-1.5	V _{CC} = MIN, I _{IN} = -18mA	V	
V _{OH}	Output HIGH Voltage	54	2.4	3.4		I _{OH} = -1.0mA	V _{CC} = MIN, V _{IN} = V _{IH} or V _{IL} per truth table	V
		74	2.4	3.1		I _{OH} = -2.6mA		
V _{OL}	Output LOW Voltage	54,74		0.25	0.4	I _{OL} = 12mA	V _{CC} = MIN, V _{IN} = V _{IH} or V _{IL} per truth table	V
		74		0.35	0.5	I _{OL} = 24mA		
I _{OZH}	Output Off Current HIGH				20	V _{CC} = MAX, V _{OUT} = 2.7V, V _E = 2.0V	μA	
I _{OZL}	Output Off Current LOW				-20	V _{CC} = MAX, V _{OUT} = 0.4V, V _E = 2.0V	μA	
I _{IH}	Input HIGH Current				20	V _{CC} = MAX, V _{IN} = 2.7V	μA	
	Input HIGH Current at MAX Input Voltage				0.1	V _{CC} = MAX, V _{IN} = 7.0V	mA	
I _{IL}	Input LOW Current				-0.4	V _{CC} = MAX, V _{IN} = 0.4V	mA	
I _{OS}	Output Short Circuit Current (Note 2)		30		130	V _{CC} = MAX, V _{OUT} = 0V	mA	
I _{CC}	Power Supply Current Outputs Off			24	40	V _{CC} = MAX, V _{IN} = 0V, V _E = 4.5V	mA	

AC CHARACTERISTICS: (T_A = 25°C)

Symbol	Parameter		Limits			Test Conditions	Units	
			Min.	Typ.	Max.			
t _{PLH}	Propagation Delay, Data to Output			12	18	Fig. 1	V _{CC} = 5.0V C _L = 45pF R _L = 667Ω	ns
t _{PHL}				12	18			
t _{PLH}	Propagation Delay, Clock or LE to Output			20	30	Fig. 1		ns
t _{PHL}				18	30			
t _{PZH}	Output Enable Time to HIGH Level			15	28	Figs. 3,4		ns
t _{PZL}	Output Enable Time to LOW Level			25	36	Figs. 2,4		ns
t _{PLZ}	Output Disable Time from LOW Level			15	25	Figs. 2,4	V _{CC} = 5.0V C _L = 5pF R _L = 667Ω	ns
t _{PHZ}	Output Disable Time from HIGH Level			12	20	Figs. 3,4		ns

Notes:

- 1) Conditions for testing, not shown in the Table, are chosen to guarantee operation under "worst case" conditions.
- 2) Not more than one output should be shorted at a time.
- 3) Typical values are at V_{CC} = 5.0V, T_A = 25°C



AC SET-UP REQUIREMENTS: $T_A = 25^\circ\text{C}$

Symbol	Parameter	Limits			Test Conditions	Units
		Min.	Typ.	Max.		
t_{sD}	Set-up Time Data to Negative Going LE	5			Fig. 1 $V_{CC} = 5.0\text{V}$	ns
t_{hD}	Hold Time Data to Negative Going LE	20				ns
t_{wLE}	Minimum LE Pulse Width HIGH to LOW	15				ns

DEFINITION OF TERMS:

SET-UP TIME (t_s) - is defined as the minimum time required for the correct logic level to be present at the logic input: to LE transition from HIGH to LOW in order to be recognized and transferred to the outputs.

HOLD TIME (t_h) - is defined as the minimum time following LE transition from LOW to HIGH that the logic level must be maintained at the input in order to ensure continued recognition.

AC WAVEFORMS

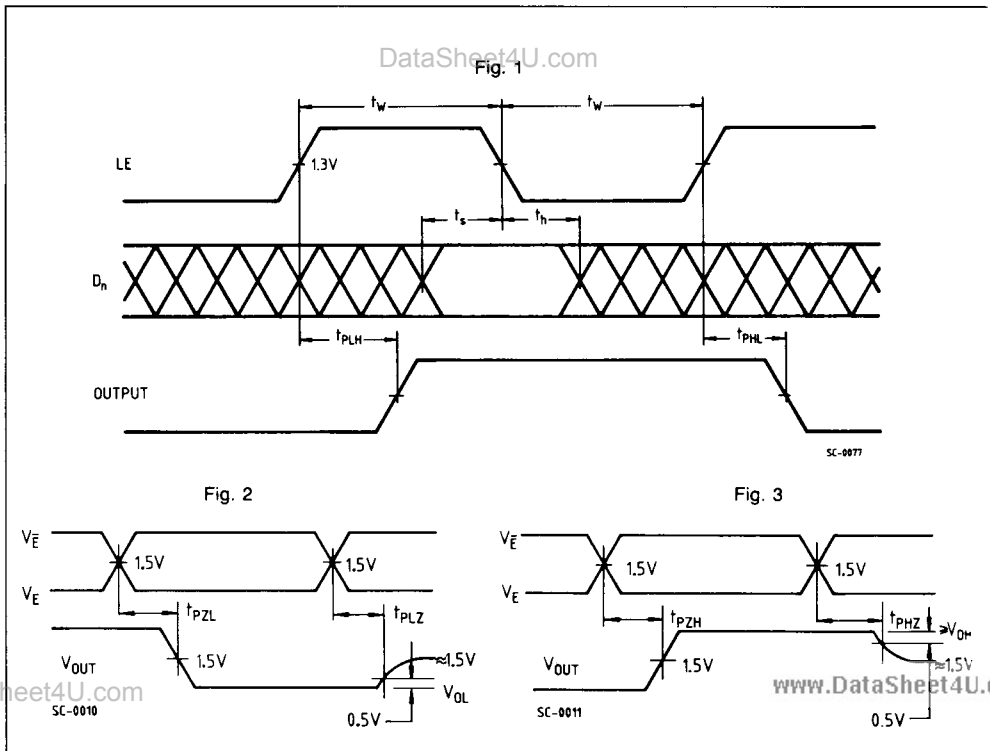

AC LOAD CIRCUIT

Fig. 4

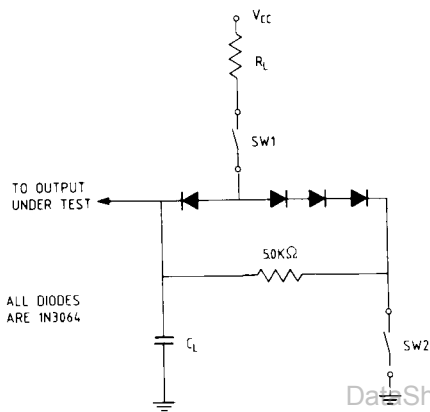

SWITCHING POSITIONS

Symbol	SW1	SW2
t_{PZH}	Open	Closed
t_{PZL}	Closed	Open
t_{PLZ}	Closed	Closed
t_{PHZ}	Closed	Closed

DataSheet4U.com

SC-0012