

# Surface Mount Common Mode Chokes

Suited for LAN and Telecom Applications

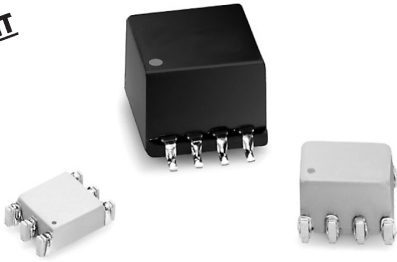

- Reduces radiated EMI emissions
- Filters common mode noise for EMI reduction
- Common mode attenuation from 100 kHz to 1 GHz
- RoHS peak reflow solder temperature rating 245°C

## Electrical Specifications @ 25°C

Part Number	No. of Ports	Primary Inductance OCL (μH MIN)	Common Mode Attenuation (dB TYP)									DCR (Ω MAX)
			100 KHz	1 MHz	10 MHz	30 MHz	50 MHz	100 MHz	300 MHz	500 MHz	1 GHz	
PE-68624NL <sup>2a</sup>	1	47	11	27	40	44	42	36	26	17	-	0.40
PE-65855NL <sup>2a</sup>	1	4700	41	43	49	39	34	26	20	20	12	1.0
PE-65857NL <sup>2a</sup>	4	22.5	7	20	30	37	38	34	24	13	-	0.22
PE-68627NL <sup>2a</sup>	4	24	8	21	32	36	37	36	30	20	-	0.25
PE-65854NL <sup>2a</sup>	4	47	3	19	32	36	35	29	12	6	-	0.40
PE-67540NL <sup>2a</sup>	4	100	14	33	44	48	49	44	34	29	20	0.60
T8008NL <sup>2a</sup>	8	47	7	27	40	44	42	36	26	-	-	0.40

### Notes:

- For Tape & Reel packaging, add suffix "T" to the end of the part number e.g. T8008NLT
- MSL = Moisture Sensitivity Level a=1 b=2 c=3 d=4

## Mechanical

## Schematic

### PE-68624NL

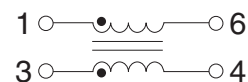
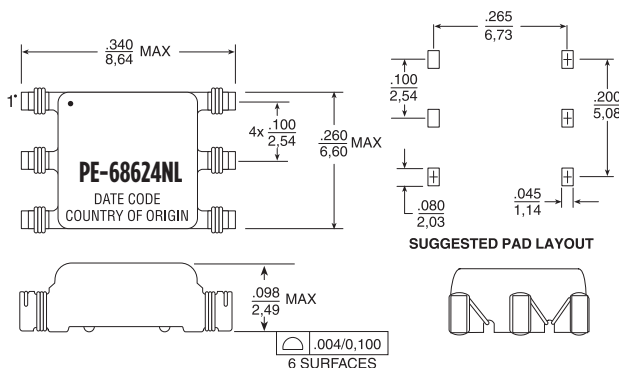

Weight .....0.17 grams  
Tape & Reel .....1500/reel  
Tube .....85/tray

Dimensions:  $\frac{\text{Inches}}{\text{mm}}$

Unless otherwise specified, all tolerances are  $\pm \frac{.010}{0,25}$

USA 858 674 8100

Germany 49 7032 7806 0

Singapore 65 6287 8998

Shanghai 86 21 62787060

China 86 755 33966678

Taiwan 886 3 4356768

# Surface Mount Common Mode Chokes

Suited for LAN and Telecom Applications



## Mechanicals

## Schematics

### PE-65854NL

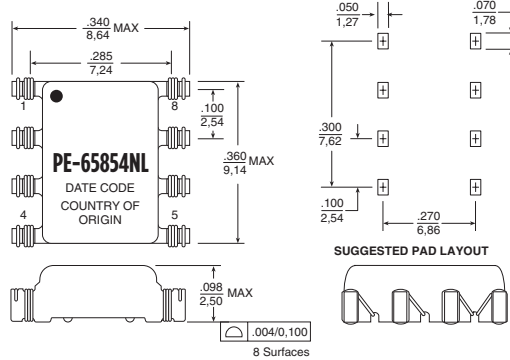

Weight .....0.3 grams  
Tape & Reel .....1500/reel  
Tube .....60/tray

Dimensions:  $\frac{\text{Inches}}{\text{mm}}$

Unless otherwise specified,  
all tolerances are  $\pm \frac{.010}{0,25}$

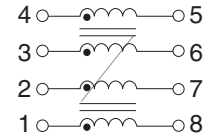

### PE-65855NL

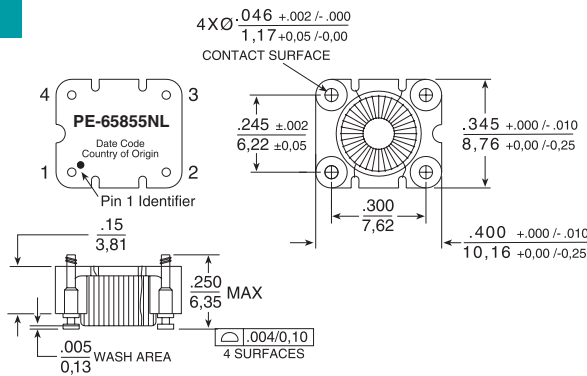

Weight .....0.69 grams  
Tape & Reel .....800/reel  
Tube .....40/tray

Dimensions:  $\frac{\text{Inches}}{\text{mm}}$

Unless otherwise specified,  
all tolerances are  $\pm \frac{.010}{0,25}$

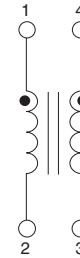

### PE-65857NL, PE-67540NL

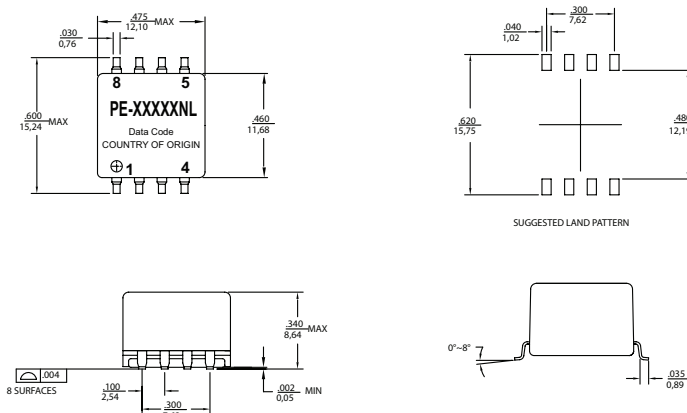

Weight .....2.0 grams  
Tape & Reel .....250/reel  
Tube .....40/tray

Dimensions:  $\frac{\text{Inches}}{\text{mm}}$

Unless otherwise specified,  
all tolerances are  $\pm \frac{.010}{0,25}$

### PE-65857NL PE-67540NL

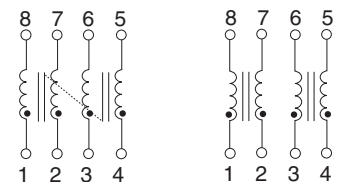

### PE-68627NL

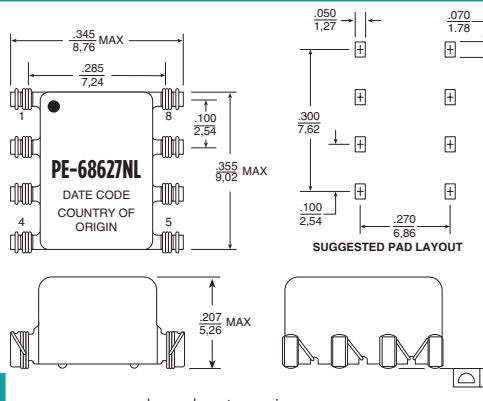

Weight .....0.3 grams  
Tape & Reel .....1500/reel  
Tube .....55/tray

Dimensions:  $\frac{\text{Inches}}{\text{mm}}$

Unless otherwise specified,  
all tolerances are  $\pm \frac{.010}{0,25}$

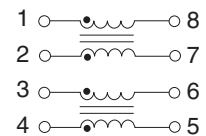

# Surface Mount Common Mode Chokes

Suited for LAN and Telecom Applications

## Mechanical

## Schematic

### T8008NL

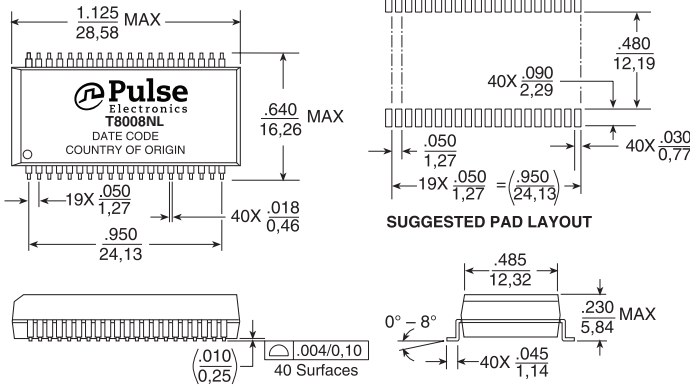

**Weight** .....4.0 grams  
**Tape & Reel** .....250/reel  
**Tube** .....15/tray

**Dimensions:** Inches  
mm

Unless otherwise specified,  
all tolerances are  $\pm \frac{.010}{0,25}$

### T8008NL

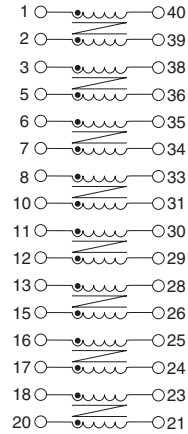

## Common Mode Test Circuit for Surface Mount and Through Hole

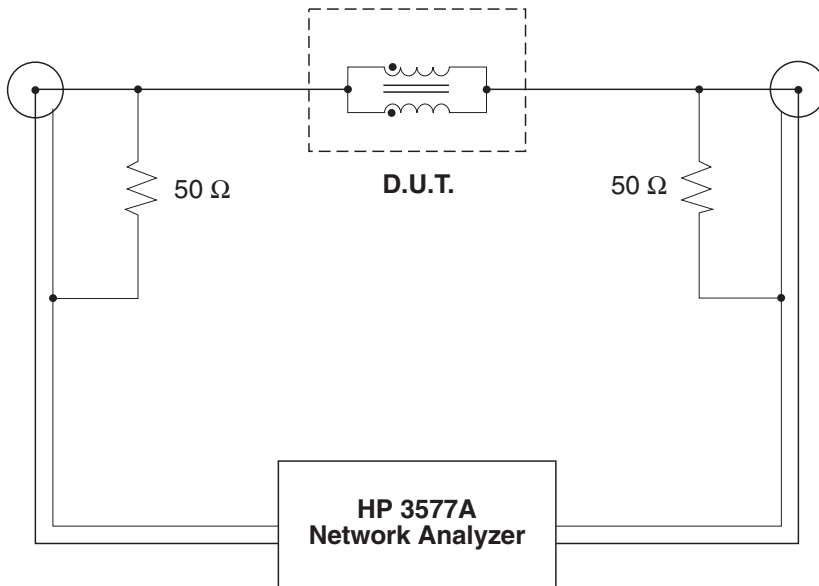

### Test Notes:

1. Network analyzer calibrated to compensate for 50  $\Omega$  resistors.
2. All windings on a core are connected in parallel for the test.
3. For multi-core chokes, test data is for one core only. The windings on the other core(s) are left unconnected (i.e. open).

## For More Information

**Pulse Worldwide Headquarters**  
 12220 World Trade Drive  
 San Diego, CA  
 92128  
 U.S.A.

**Pulse Europe**  
 Einsteinstrasse 1  
 D-71083 Herrenberg  
 Germany

**Pulse China Headquarters**  
 B402, Shenzhen Academy of  
 Aerospace Technology Bldg.  
 10th Kejinan Road  
 High-Tech Zone  
 Nanshan District  
 Shenzhen, PR China  
 518057  
 Tel: 86 755 33966678  
 Fax: 86 755 33966700

**Pulse North China**  
 Room 2704/2705  
 Super Ocean Finance  
 Ctr.  
 2067 Yan An Road  
 West  
 Shanghai 200336  
 China  
 Tel: 86 21 62787060  
 Fax: 86 2162786973

**Pulse South Asia**  
 135 Joo Seng Road  
 #03-02  
 PM Industrial Bldg.  
 Singapore 368363  
 Tel: 65 6287 8998  
 Fax: 65 6287 8998

**Pulse North Asia**  
 3F, No. 198  
 Zhongyuan Road  
 Zhongli City  
 Taoyuan County 320  
 Taiwan R. O. C.  
 Tel: 886 3 4356768  
 Fax: 886 3 4356823 (Pulse)  
 Fax: 886 3 4356820 (FRE)

Performance warranty of products offered on this data sheet is limited to the parameters specified. Data is subject to change without notice. Other brand and product names mentioned herein may be trademarks or registered trademarks of their respective owners. © Copyright, 2012. Pulse Electronics, Inc. All rights reserved.