



T835-600G
T850-600G

HIGH PERFORMANCE TRIAC

FEATURES

HIGH COMMUTATION PERFORMANCES
 SNUBBERLESS™ TECHNOLOGY
 HIGH NOISE IMMUNITY (dV/dt)
 HIGH I_{TSM}

DESCRIPTION

The T835-600G and T850-600G triacs are using high performance SNUBBERLESS technology.

They are intended for AC control applications using surface mount technology.

These devices are perfectly suited where high commutation and surge performances are required.

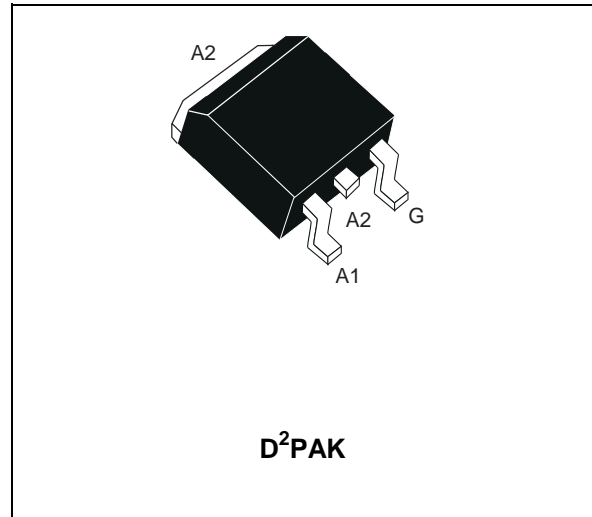

ABSOLUTE RATINGS (limiting values)

Symbol	Parameter	Value	Unit	
V_{DRM} V_{RRM}	Repetitive peak off-state voltage	$T_j = 125^\circ\text{C}$ 600	V	
$I_{T(RMS)}$	RMS on-state current (360° conduction angle)	$T_c = 110^\circ\text{C}$ 8	A	
I_{TSM}	Non repetitive surge peak on-state current (T_j initial = 25°C)	$t_p = 8.3\text{ms}$	85	A
		$t_p = 10\text{ms}$	80	
I^2t	I^2t Value for fusing	$t_p = 10\text{ms}$ 32	A^2s	
dI/dt	Critical rate of rise of on-state current $I_G = 500\text{mA}$ $dI_G/dt = 1\text{A}/\mu\text{s}$.	Repetitive F = 50 Hz	20	$\text{A}/\mu\text{s}$
		Non Repetitive	100	
T_{stg} T_j	Storage temperature range Operating junction temperature range	- 40, + 150 - 40, + 125	$^\circ\text{C}$	
T	Maximum temperature for soldering during 10s	260	$^\circ\text{C}$	

T835-600G / T850-600G

THERMAL RESISTANCES

Symbol	Parameter	Value	Unit
Rth(j-a)	Junction to ambient (S = 1 cm ²)	45	°C/W
Rth(j-c)	Junction to case for DC	2.1	°C/W
Rth(j-c)	Junction to case for AC 360° conduction angle (F=50Hz)	1.6	°C/W

GATE CHARACTERISTICS (maximum values)

$P_{G(AV)} = 1 \text{ W}$ $P_{GM} = 10 \text{ W}$ ($t_p = 20 \mu\text{s}$) $I_{GM} = 4 \text{ A}$ ($t_p = 20 \mu\text{s}$)

ELECTRICAL CHARACTERISTICS

Symbol	Test Conditions		Quadrant		T835	T850	Unit
I_{GT}	$V_D = 12\text{V (DC)}$ $R_L = 33\Omega$	$T_j = 25^\circ\text{C}$	I-II-III	MIN	2		mA
				MAX	35	50	
V_{GT}	$V_D = 12\text{V (DC)}$ $R_L = 33\Omega$	$T_j = 25^\circ\text{C}$	I-II-III	MAX	1.3		V
V_{GD}	$V_D = V_{DRM}$ $R_L = 3.3\text{k}\Omega$	$T_j = 125^\circ\text{C}$	I-II-III	MIN	0.2		V
I_H^*	$I_T = 100\text{mA}$ Gate open	$T_j = 25^\circ\text{C}$		MAX	35	50	mA
I_L	$I_G = 1.2 I_{GT}$	$T_j = 25^\circ\text{C}$	I-III	MAX	50	60	mA
			II	MAX	80	100	
V_{TM}^*	$I_{TM} = 11\text{A}$ $t_p = 380\mu\text{s}$	$T_j = 25^\circ\text{C}$		MAX	1.5		V
I_{DRM}	$V_D = V_{DRM}$	$T_j = 25^\circ\text{C}$		MAX	5		μA
I_{RRM}	$V_R = V_{RRM}$	$T_j = 125^\circ\text{C}$		MAX	2		mA
dV/dt^*	Linear slope up to $V_D = 67\% V_{DRM}$ Gate open	$T_j = 125^\circ\text{C}$		MIN	500	1000	$\text{V}/\mu\text{s}$
$(di/dt)_c^*$	Without snubber	$T_j = 125^\circ\text{C}$		MIN	4.5	7	A/ms

* For either polarity of electrode A2 voltage with reference to electrode A1.

ORDERING INFORMATION Add "-TR" suffix for Tape & Reel shipment

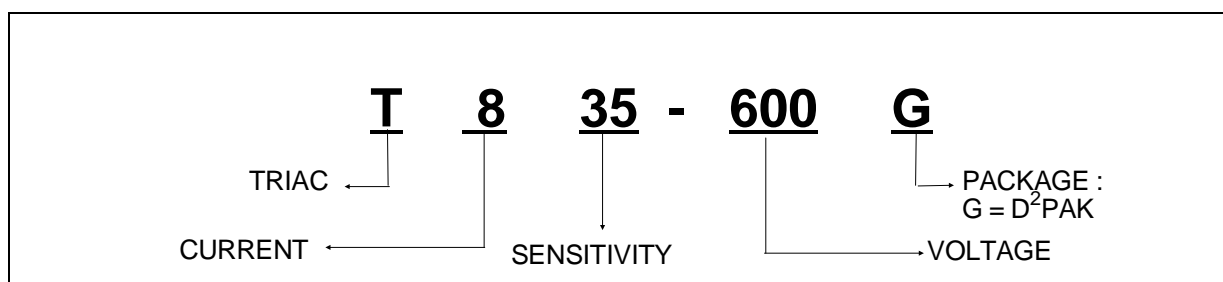

Fig. 1: Maximum power dissipation versus RMS on-state current.

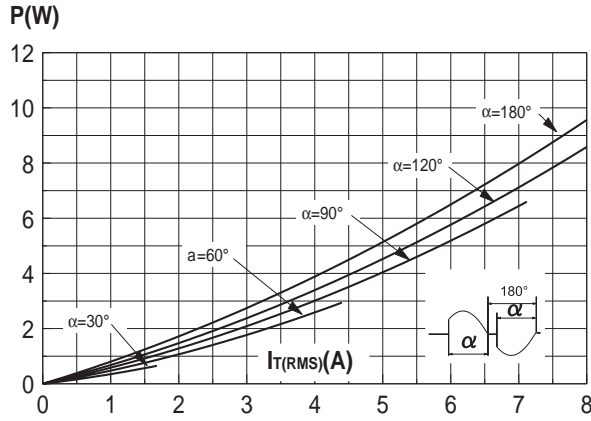

Fig. 3: RMS on-state current versus case temperature.

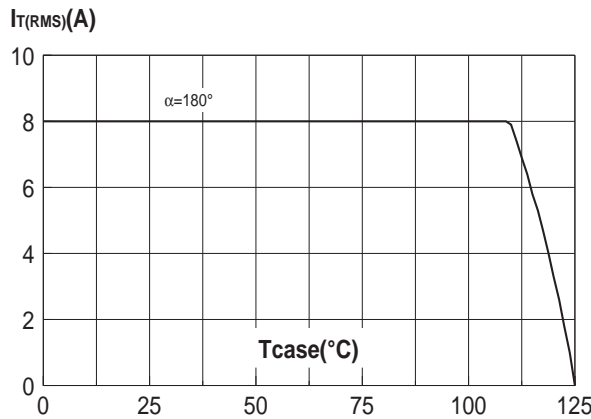

Fig. 5: Relative variation of gate trigger current and holding current versus junction temperature (typical values).

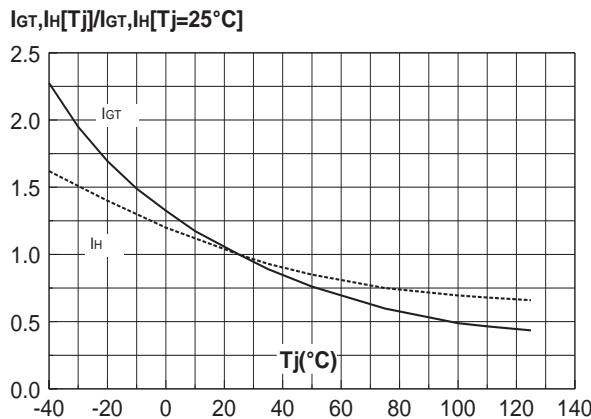

Fig. 2: Correlation between maximum power dissipation and maximum allowable temperatures (Tamb and Tcase) for different thermal resistances heatsink+contact.

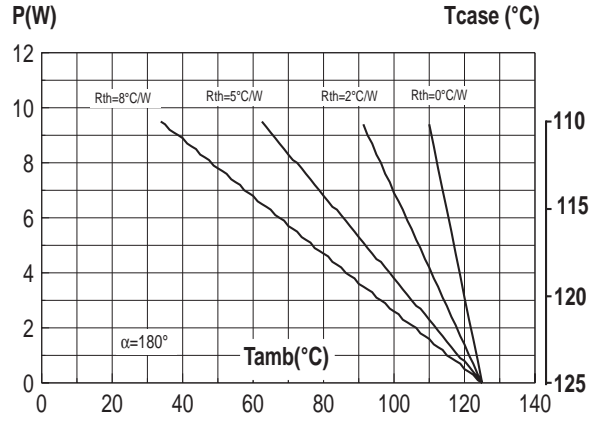

Fig. 4 : Relative variation of thermal impedance versus pulse duration.

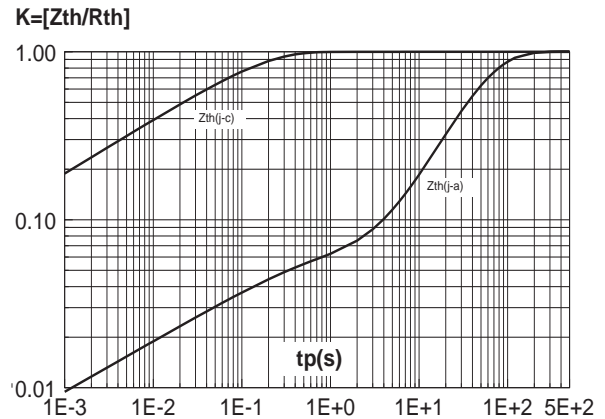

Fig. 6: Non repetitive surge peak on-state current versus number of cycles.

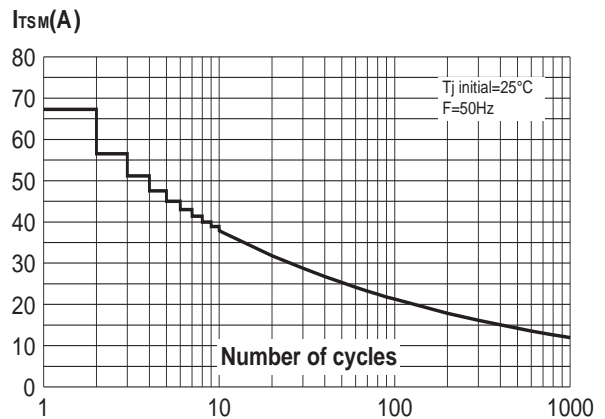

Fig. 7: Non repetitive surge peak on-state current for a sinusoidal pulse with width $t_p < 10\text{ms}$, and corresponding value of I^2t .

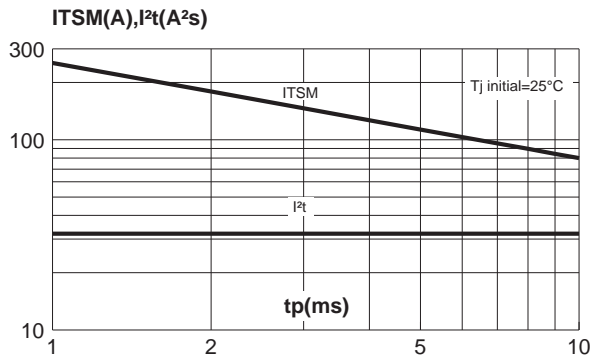

Fig. 9: Thermal resistance junction to ambient versus copper surface under tab (Epoxy printed circuit board FR4, copper thickness: $35\mu\text{m}$).

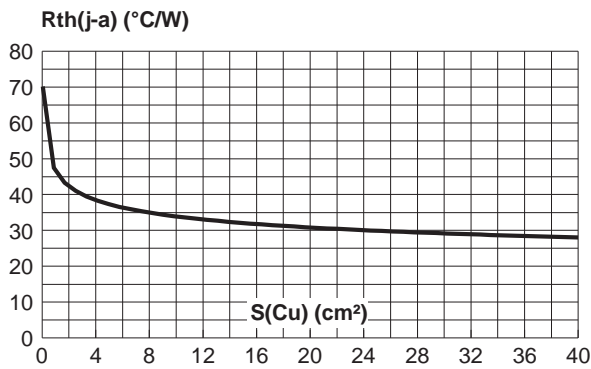

Fig. 8: On-state characteristics (maximum values).

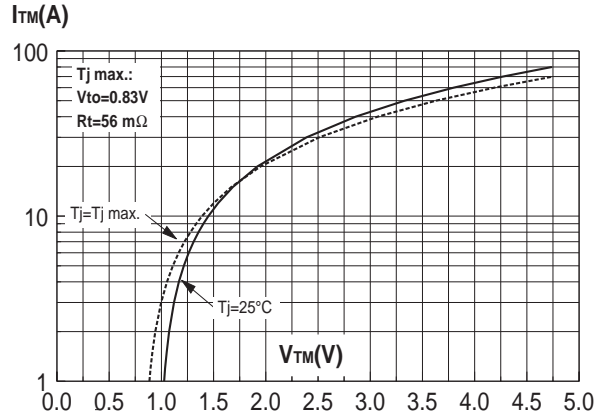
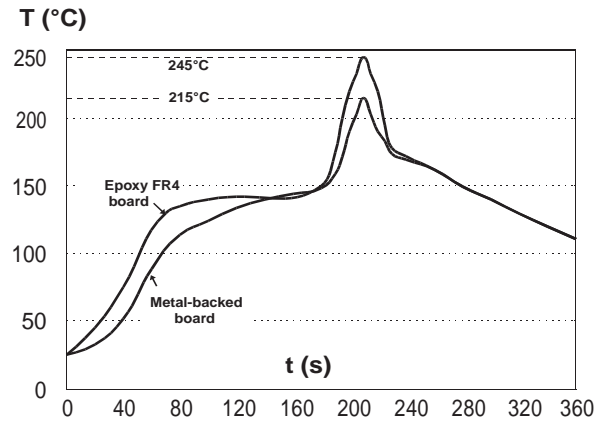
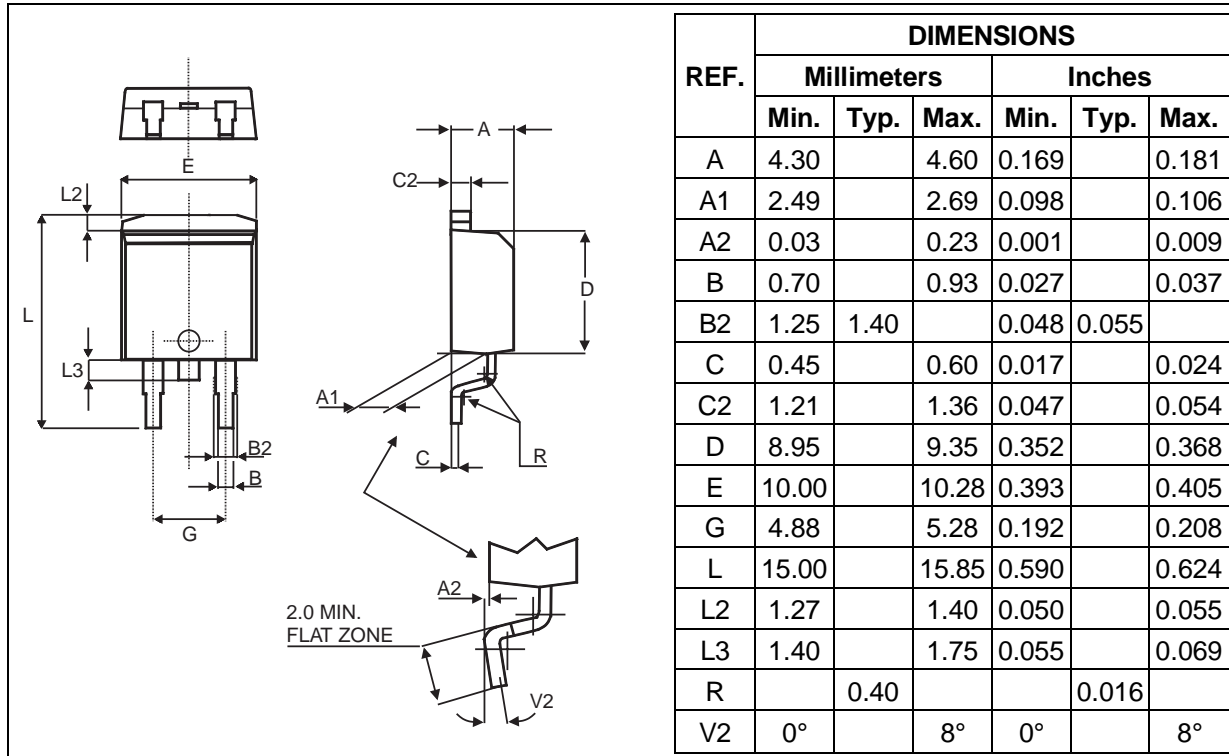

Fig. 10: Typical reflow soldering heat profile, either for mounting on FR4 or metal-backed boards.



PACKAGE MECHANICAL DATA
D²PAK



FOOT PRINT DIMENSIONS (in millimeters)

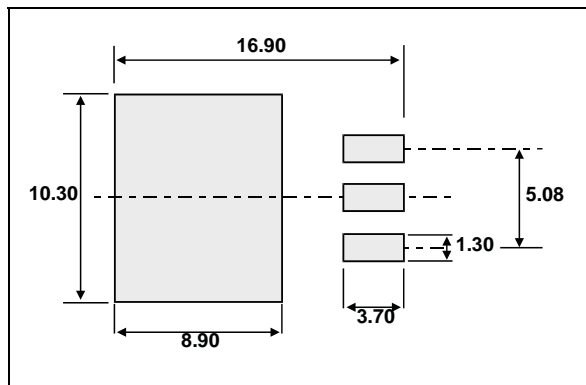

MARKING

TYPE	MARKING
T835-600G	T835 600G
T850-600G	T850 600G

PACKING

Tube : 50 units
Tape and reel : 500 units

Information furnished is believed to be accurate and reliable. However, STMicroelectronics assumes no responsibility for the consequences of use of such information nor for any infringement of patents or other rights of third parties which may result from its use. No license is granted by implication or otherwise under any patent or patent rights of STMicroelectronics. Specification mentioned in this publication are subject to change without notice. This publication supersedes and replaces all information previously supplied. STMicroelectronics products are not authorized for use as critical components in life support devices or systems without express written approval of STMicroelectronics.

The ST logo is a trademark of STMicroelectronics

© 1998 STMicroelectronics – Printed in Italy – All Rights Reserved

STMicroelectronics GROUP OF COMPANIES

Australia - Brazil - Canada - China - France - Germany - Italy - Japan - Korea - Malaysia - Malta - Morocco - The Netherlands - Singapore - Spain - Sweden - Switzerland - Taiwan - Thailand - United Kingdom - U.S.A.