

TA-333

*US Model
Canadian Model
AEP Model
UK Model
E Model
SCN Model*

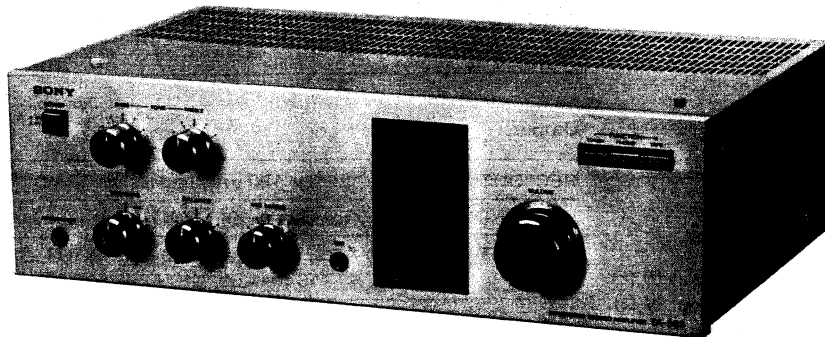

INTEGRATED STEREO AMPLIFIER

SPECIFICATIONS

GENERAL

SAFETY-RELATED COMPONENT WARNING!!

COMPONENTS IDENTIFIED BY SHADING AND MARK  ON THE SCHEMATIC DIAGRAMS, EXPLODED VIEWS AND IN THE PARTS LIST ARE CRITICAL TO SAFE OPERATION. REPLACE THESE COMPONENTS WITH SONY PARTS WHOSE PART NUMBERS APPEAR AS SHOWN IN THIS MANUAL OR IN SUPPLEMENTS PUBLISHED BY SONY.

ATTENTION AU COMPOSANT AYANT RAPPORT À LA SÉCURITÉ!

LES COMPOSANTS IDENTIFIÉS PAR UNE TRAME ET UNE MARQUE  SUR LES DIAGRAMMES SCHEMATIQUES, LES VUES EXPLOSÉES ET LA LISTE DES PIÈCES SONT CRITIQUES POUR LA SÉCURITÉ DE FONCTIONNEMENT. NE REMPLACER CES COMPOSANTS QUE PAR DES PIÈCES SONY DONT LES NUMÉROS SONT DONNÉS DANS CE MANUEL OU DANS LES SUPPLÉMENTS PUBLIÉS PAR SONY.

System: Direct output coupling, pure-complementary symmetry power amplifier circuit (SEPP OTL)

Power Requirements: 120 V ac \sim , 60 Hz (US, Canadian model)
240 V ac \sim , 50 Hz (UK model)
220 V ac \sim , 50 Hz (AEP, SCN model)
120, 220 or 240 V ac \sim adjustable,
50/60 Hz (E model)

Power Consumption: 95 W (US, Canadian model)
180 W (AEP, E, SCN model)
240 W (UK model)

Ac Outlets: 1 switched (100 W)
(not provided for
SCN model) 2 unswitched (total 200 W)

Dimensions: Approx. 430 (w) x 135 (h) x 290 (d) mm
17 (w) x 5 1/4 (h) x 11 1/2 (d) inches
including projecting parts and controls

Weight: Approx. 6.2 kg, 13 lb 11 oz net
Approx. 7.6 kg, 16 lb 12 oz in shipping
carton (AEP, E, UK, SCN model)
Approx. 5.5 kg, 12 lb 2 oz net
Approx. 7 kg, 15 lb 7 oz in shipping carton
(US, Canadian model)

— Continued on page 2 —

SONY
SERVICE MANUAL

TA-333

AMPLIFIER SECTION

Power Output and Total Harmonic Distortion: (US, Canadian model) With 8 Ω loads, both channels driven, from 20 – 20,000 Hz; rated 25 W per channel minimum RMS power, with no more than 0.3 % total harmonic distortion from 250 mW to rated output.

Continuous RMS Power Output: Less than 0.3% (8 Ω) or 0.3% (4 Ω) THD. both channels driven simultaneously (AEP, UK, E, SCN model)

Power Bandwidth (IHF): 10 Hz – 30 kHz (8 Ω)

Harmonic Distortion: Less than 0.3 % at rated output (8 Ω)
Less than 0.3 % at rated output (4 Ω)
Less than 0.3 % at 1 W output

Intermodulation (IM) Distortion: Less than 0.3 % at rated output
Less than 0.3 % at 1 W output

Frequency Response: PHONO RIAA equalization curve ± 0.8 dB
TUNER) 10 Hz – 50 kHz $\begin{matrix} +1 \\ -3 \end{matrix}$ dB
TAPE)
MIC 200 Hz – 10 kHz $\begin{matrix} +0 \\ -3 \end{matrix}$ dB

Damping Factor: 30 (8 Ω , 1 kHz)

Tone Controls: BASS ± 8 dB at 100 Hz
TREBLE ± 8 dB at 10 kHz

Loudness (att. 30dB): +6 dB at 100 Hz

Inputs:

	Sensitivity	Impedance	Maximum input capability (at 1 kHz, 0.3 % distortion)	S/N (weighting network, input level)
PHONO	2.5 mV	50 k Ω	110 mV	72 dB (A, 2.5 mV)
TUNER TAPE	150 mV	50 k Ω	–	95 dB (A, 150 mV)
MIC	2 mV	10 k Ω	–	–

Outputs:

REC OUT	Voltage 150 mV, Impedance 10 k Ω
HEADPHONES	Accepts low and high impedance headphones
SPEAKER	Accepts speakers of 8 – 16 Ω (US, Canadian model) or 4 – 16 Ω (AEP, UK, E, SCN model)

MODEL IDENTIFICATION

– Specification Label –

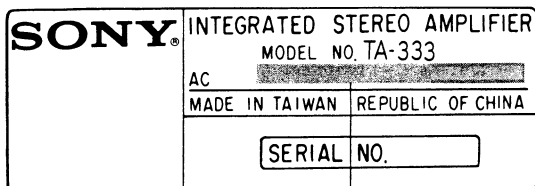

US, Canadian model: AC 120V ~ 50Hz 95W
 AEP model: AC 220V ~ 50Hz 180W
 UK model: AC 240V ~ 50Hz 240W
 E1, E2 model: AC 120, 220, 240V ~ 50/60Hz 180W

– Power Cord –

E1 model: euro-plug 1-551-896-00

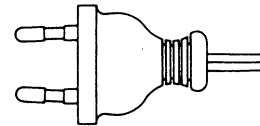

E2 model: parallel-blade plug 1-551-628-00

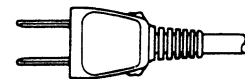

1. BLOCK DIAGRAM

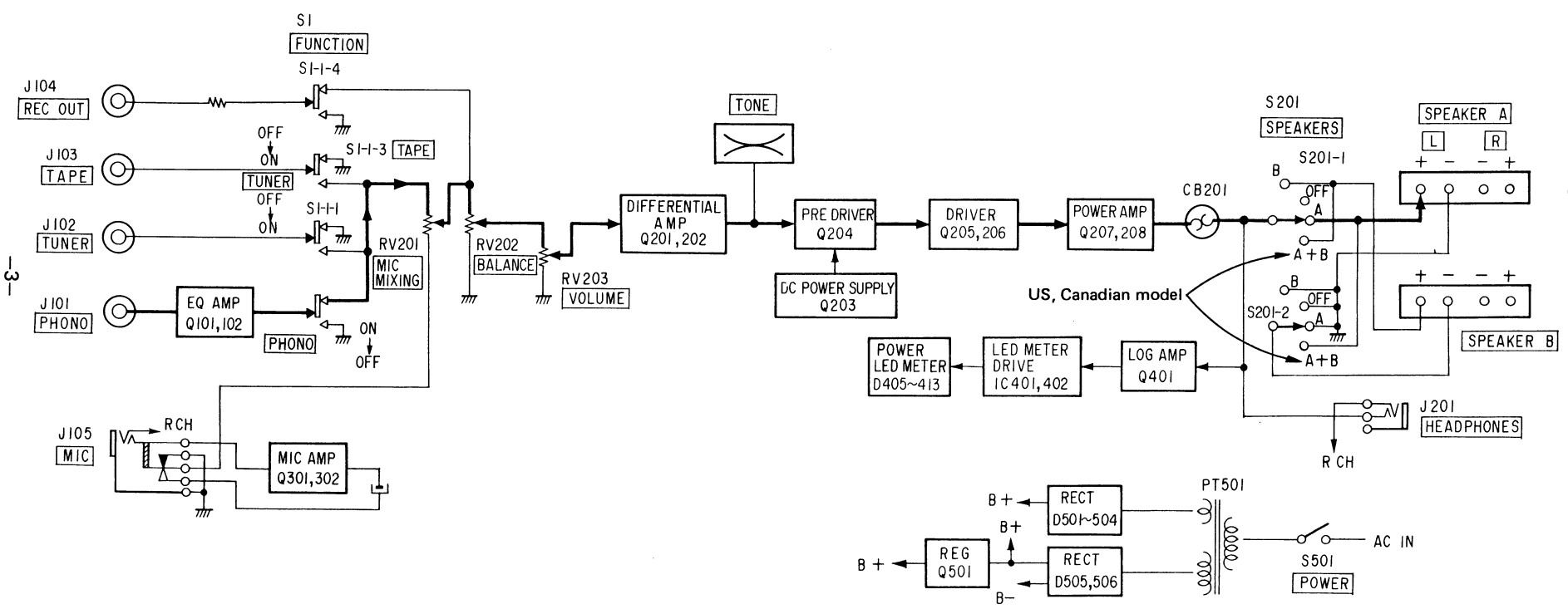

SECTION 1
OUTLINE

**SECTION 2
DISASSEMBLY**

Note:

- Follow the disassembly procedure in the numerical order given.

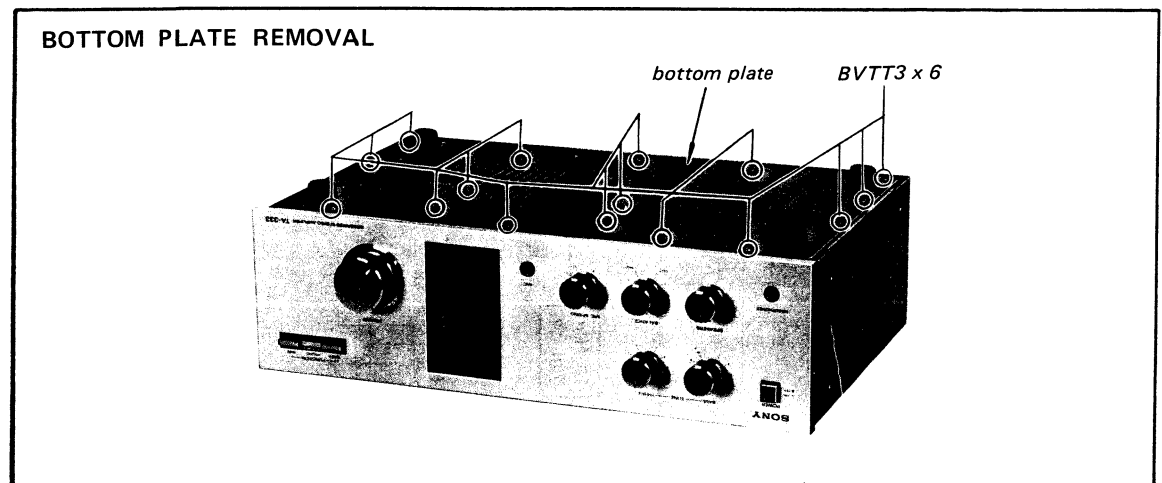
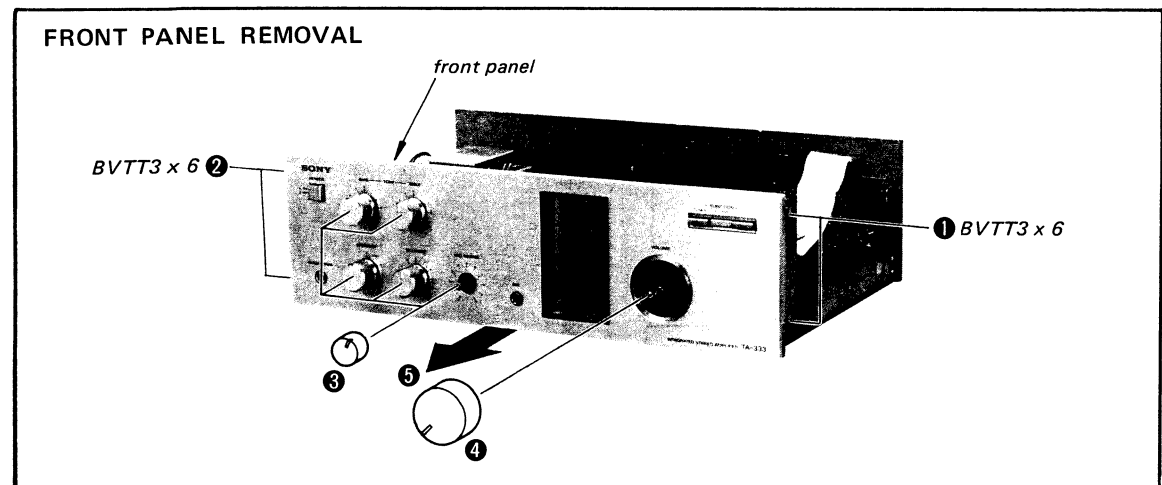
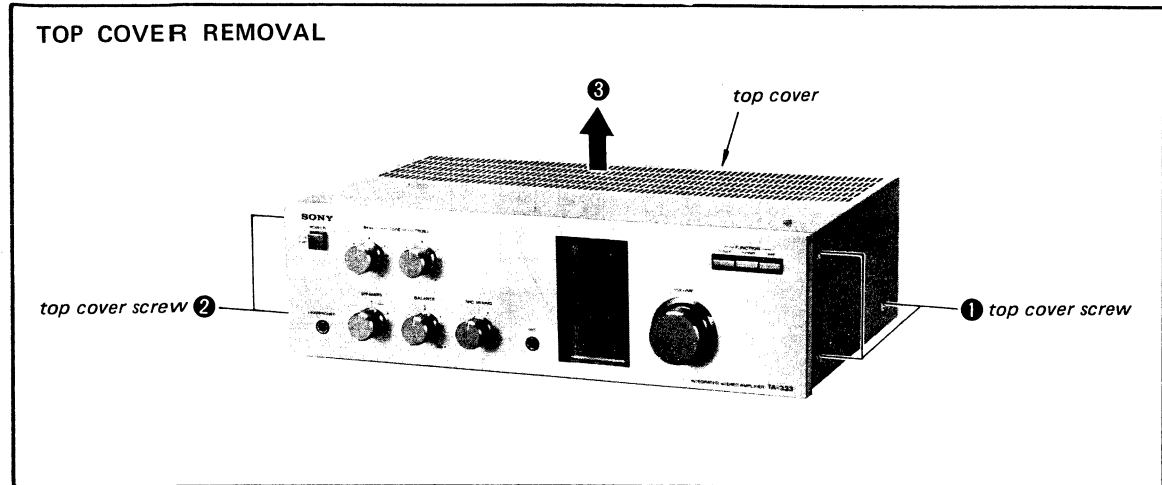

SECTION 3 ADJUSTMENTS

3-1. IDLING CURRENT ADJUSTMENT

Setting:

VOLUME control: minimum (fully counterclockwise)

Procedure:

Adjust RT206 (L-CH) and RT256 (R-CH) for 16mV dc reading on the VOM.

Adjustment Location:

– power amp board –

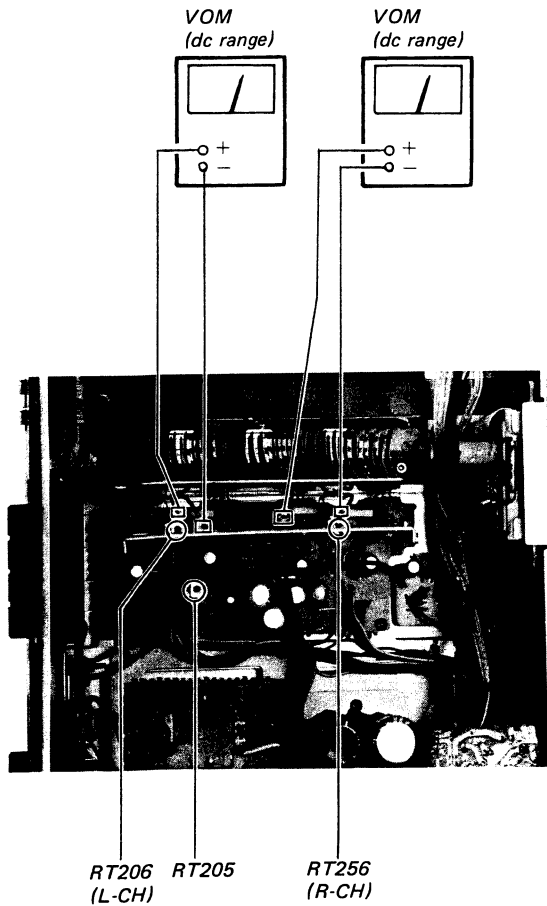

3-2. POWER LEVEL METER ADJUSTMENT

Setting:

FUNCTION switch: TUNER

Procedure:

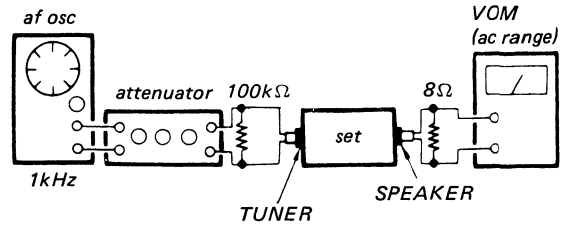

1. Turn the VOLUME control for a 2.83V (1W) reading on VOM.
2. Adjust RT402 (L-CH) and RT452 (R-CH) so that the power meter indicates 1W.
3. Adjust RT401 (L-CH) and RT451 (R-CH) so that the power meter indicates 25W.

Adjustment Location:

– power amp board –

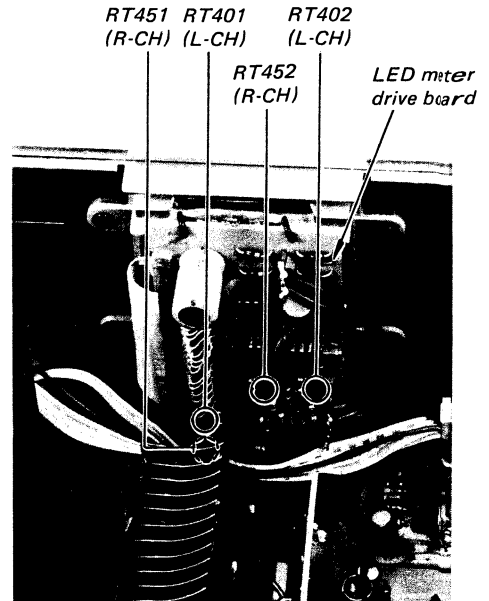

3-3. DC BALANCE ADJUSTMENT

Procedure:

Adjust RT205 for -70mV to $+70\text{mV}$ reading on the VOM.

Adjustment Location:

– power amp board –

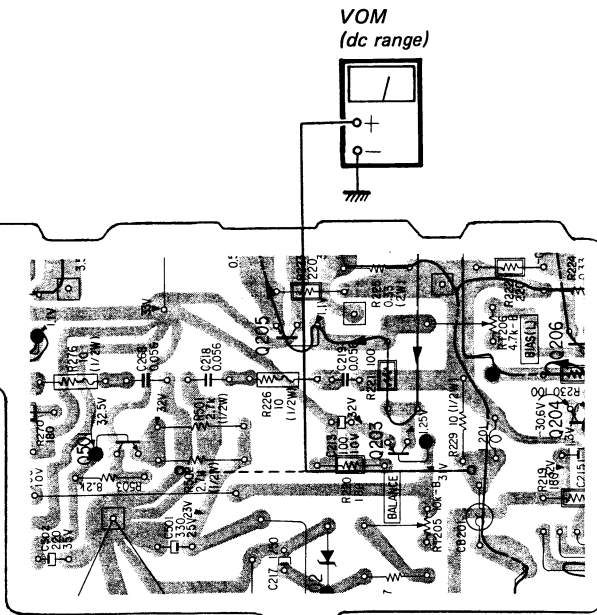

– R-CH –
test point

– L-CH –
test point









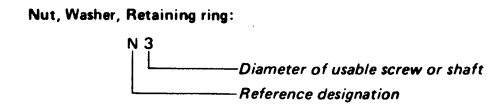
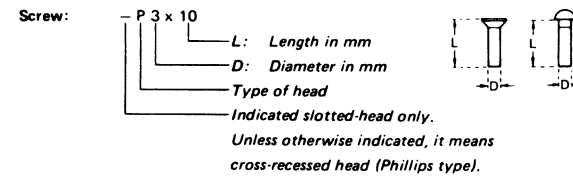



MEMO













1/4 WATT CARBON RESISTORS ^(A) Note: Circled letter (A) is applicable to European models only.

Ω	Part No.	Ω	Part No.	Ω	Part No.	Ω	Part No.	Ω	Part No.	Ω	Part No.	Ω	Part No.
1.0	1-246-401-00	10	1-246-425-00	100	1-246-449-00	1.0k	1-246-473-00	10k	1-246-497-00	100k	1-246-521-00	1.0M	1-246-545-00
1.1	1-246-402-00	11	1-246-426-00	110	1-246-450-00	1.1k	1-246-474-00	11k	1-246-498-00	110k	1-246-522-00	1.1M	1-210-814-00
1.2	1-246-403-00	12	1-246-427-00	120	1-246-451-00	1.2k	1-246-475-00	12k	1-246-499-00	120k	1-246-523-00	1.2M	1-210-815-00
1.3	1-246-404-00	13	1-246-428-00	130	1-246-452-00	1.3k	1-246-476-00	13k	1-246-500-00	130k	1-246-524-00	1.3M	1-210-816-00
1.5	1-246-405-00	15	1-246-429-00	150	1-246-453-00	1.5k	1-246-477-00	15k	1-246-501-00	150k	1-246-525-00	1.5M	1-210-817-00
1.6	1-246-406-00	16	1-246-430-00	160	1-246-454-00	1.6k	1-246-478-00	16k	1-246-502-00	160k	1-246-526-00	1.6M	1-210-818-00
1.8	1-246-407-00	18	1-246-431-00	180	1-246-455-00	1.8k	1-246-479-00	18k	1-246-503-00	180k	1-246-527-00	1.8M	1-210-819-00
2.0	1-246-408-00	20	1-246-432-00	200	1-246-456-00	2.0k	1-246-480-00	20k	1-246-504-00	200k	1-246-528-00	2.0M	1-210-820-00
2.2	1-246-409-00	22	1-246-433-00	220	1-246-457-00	2.2k	1-246-481-00	22k	1-246-505-00	220k	1-246-529-00	2.2M	1-210-821-00
2.4	1-246-410-00	24	1-246-434-00	240	1-246-458-00	2.4k	1-246-482-00	24k	1-246-506-00	240k	1-246-530-00	2.4M	1-244-754-00
2.7	1-246-411-00	27	1-246-435-00	270	1-246-459-00	2.7k	1-246-483-00	27k	1-246-507-00	270k	1-246-531-00	2.7M	1-244-755-00
3.0	1-246-412-00	30	1-246-436-00	300	1-246-460-00	3.0k	1-246-484-00	30k	1-246-508-00	300k	1-246-532-00	3.0M	1-244-756-00
3.3	1-246-413-00	33	1-246-437-00	330	1-246-461-00	3.3k	1-246-485-00	33k	1-246-509-00	330k	1-246-533-00	3.3M	1-244-757-00
3.6	1-246-414-00	36	1-246-438-00	360	1-246-462-00	3.6k	1-246-486-00	36k	1-246-510-00	360k	1-246-534-00	3.6M	1-244-758-00
3.9	1-246-415-00	39	1-246-439-00	390	1-246-463-00	3.9k	1-246-487-00	39k	1-246-511-00	390k	1-246-535-00	3.9M	1-244-759-00
4.3	1-246-416-00	43	1-246-440-00	430	1-246-464-00	4.3k	1-246-488-00	43k	1-246-512-00	430k	1-246-536-00	4.3M	1-244-760-00
4.7	1-246-417-00	47	1-246-441-00	470	1-246-465-00	4.7k	1-246-489-00	47k	1-246-513-00	470k	1-246-537-00	4.7M	1-244-761-00
5.1	1-246-418-00	51	1-246-442-00	510	1-246-466-00	5.1k	1-246-490-00	51k	1-246-514-00	510k	1-246-538-00	5.1M	1-244-762-00
5.6	1-246-419-00	56	1-246-443-00	560	1-246-467-00	5.6k	1-246-491-00	56k	1-246-515-00	560k	1-246-539-00		
6.2	1-246-420-00	62	1-246-444-00	620	1-246-468-00	6.2k	1-246-492-00	62k	1-246-516-00	620k	1-246-540-00		
6.8	1-246-421-00	68	1-246-445-00	680	1-246-469-00	6.8k	1-246-493-00	68k	1-246-517-00	680k	1-246-541-00		
7.5	1-246-422-00	75	1-246-446-00	750	1-246-470-00	7.5k	1-246-494-00	75k	1-246-518-00	750k	1-246-542-00		
8.2	1-246-423-00	82	1-246-447-00	820	1-246-471-00	8.2k	1-246-495-00	82k	1-246-519-00	820k	1-246-543-00		
9.1	1-246-424-00	91	1-246-448-00	910	1-246-472-00	9.1k	1-246-496-00	91k	1-246-520-00	910k	1-246-544-00		

HARDWARE NOMENCLATURE



Reference Designation	Shape	Description	Remarks
SCREWS			
P		pan-head screw	binding-head (B) screw for replacement
PWH		pan-head screw with washer face	binding-head (B) screw and flat washer for replacement
PS PSP		pan-head screw with spring washer	binding-head (B) screw and spring washer for replacement
PSW PSPW		pan-head screw with spring and flat washers	binding-head (B) screw and spring and flat washers for replacement
R		round-head screw	binding-head (B) screw for replacement
K		flat-countersunk-head screw	
RK		oval-countersunk-head screw	
B		binding-head screw	
T		truss-head screw	binding-head (B) screw for replacement
F		flat-fillister-head screw	
RF		fillister-head screw	
BV		brazer-head screw	

Reference Designation	Shape	Description	Remarks
SELF-TAPPING SCREWS			
TA		self-tapping screw	ex: TA, P 3 x 10
PTP		pan-head self-tapping screw	binding-head self-tapping (TA, B) screw for replacement
PTPWH		pan-head self-tapping screw with washer face	binding-head self-tapping (TA, B) screw and flat washer for replacement
PTTWH		pan-head thread-rolling screw with washer face	binding-head (B) screw and flat washer for replacement
SET SCREWS			
SC		set screw	
SC		hexagon-socket set screw	ex: SC 2.6 x 4, hexagon socket
NUT			
N		nut	
WASHERS			
W		flat washer	
SW		spring washer	
LW		internal-tooth lock washer	ex: LW3, internal
LW		external-tooth lock washer	ex: LW3, external
RETAINING RINGS			
E		retaining ring	
G		grip-type retaining ring	

1/4 WATT CARBON RESISTORS Ⓐ Note: Circled letter Ⓐ is applicable to European models only.

Ω	Part No.	Ω	Part No.	Ω	Part No.	Ω	Part No.	Ω	Part No.	Ω	Part No.	Ω	Part No.
1.0	1-246-401-00	10	1-246-425-00	100	1-246-449-00	1.0k	1-246-473-00	10k	1-246-497-00	100k	1-246-521-00	1.0M	1-246-545-00
1.1	1-246-402-00	11	1-246-426-00	110	1-246-450-00	1.1k	1-246-474-00	11k	1-246-498-00	110k	1-246-522-00	1.1M	1-210-814-00
1.2	1-246-403-00	12	1-246-427-00	120	1-246-451-00	1.2k	1-246-475-00	12k	1-246-499-00	120k	1-246-523-00	1.2M	1-210-815-00
1.3	1-246-404-00	13	1-246-428-00	130	1-246-452-00	1.3k	1-246-476-00	13k	1-246-500-00	130k	1-246-524-00	1.3M	1-210-816-00
1.5	1-246-405-00	15	1-246-429-00	150	1-246-453-00	1.5k	1-246-477-00	15k	1-246-501-00	150k	1-246-525-00	1.5M	1-210-817-00
1.6	1-246-406-00	16	1-246-430-00	160	1-246-454-00	1.6k	1-246-478-00	16k	1-246-502-00	160k	1-246-526-00	1.6M	1-210-818-00
1.8	1-246-407-00	18	1-246-431-00	180	1-246-455-00	1.8k	1-246-479-00	18k	1-246-503-00	180k	1-246-527-00	1.8M	1-210-819-00
2.0	1-246-408-00	20	1-246-432-00	200	1-246-456-00	2.0k	1-246-480-00	20k	1-246-504-00	200k	1-246-528-00	2.0M	1-210-820-00
2.2	1-246-409-00	22	1-246-433-00	220	1-246-457-00	2.2k	1-246-481-00	22k	1-246-505-00	220k	1-246-529-00	2.2M	1-210-821-00
2.4	1-246-410-00	24	1-246-434-00	240	1-246-458-00	2.4k	1-246-482-00	24k	1-246-506-00	240k	1-246-530-00	2.4M	1-244-754-00
2.7	1-246-411-00	27	1-246-435-00	270	1-246-459-00	2.7k	1-246-483-00	27k	1-246-507-00	270k	1-246-531-00	2.7M	1-244-755-00
3.0	1-246-412-00	30	1-246-436-00	300	1-246-460-00	3.0k	1-246-484-00	30k	1-246-508-00	300k	1-246-532-00	3.0M	1-244-756-00
3.3	1-246-413-00	33	1-246-437-00	330	1-246-461-00	3.3k	1-246-485-00	33k	1-246-509-00	330k	1-246-533-00	3.3M	1-244-757-00
3.6	1-246-414-00	36	1-246-438-00	360	1-246-462-00	3.6k	1-246-486-00	36k	1-246-510-00	360k	1-246-534-00	3.6M	1-244-758-00
3.9	1-246-415-00	39	1-246-439-00	390	1-246-463-00	3.9k	1-246-487-00	39k	1-246-511-00	390k	1-246-535-00	3.9M	1-244-759-00
4.3	1-246-416-00	43	1-246-440-00	430	1-246-464-00	4.3k	1-246-488-00	43k	1-246-512-00	430k	1-246-536-00	4.3M	1-244-760-00
4.7	1-246-417-00	47	1-246-441-00	470	1-246-465-00	4.7k	1-246-489-00	47k	1-246-513-00	470k	1-246-537-00	4.7M	1-244-761-00
5.1	1-246-418-00	51	1-246-442-00	510	1-246-466-00	5.1k	1-246-490-00	51k	1-246-514-00	510k	1-246-538-00	5.1M	1-244-762-00
5.6	1-246-419-00	56	1-246-443-00	560	1-246-467-00	5.6k	1-246-491-00	56k	1-246-515-00	560k	1-246-539-00		
6.2	1-246-420-00	62	1-246-444-00	620	1-246-468-00	6.2k	1-246-492-00	62k	1-246-516-00	620k	1-246-540-00		
6.8	1-246-421-00	68	1-246-445-00	680	1-246-469-00	6.8k	1-246-493-00	68k	1-246-517-00	680k	1-246-541-00		
7.5	1-246-422-00	75	1-246-446-00	750	1-246-470-00	7.5k	1-246-494-00	75k	1-246-518-00	750k	1-246-542-00		
8.2	1-246-423-00	82	1-246-447-00	820	1-246-471-00	8.2k	1-246-495-00	82k	1-246-519-00	820k	1-246-543-00		
9.1	1-246-424-00	91	1-246-448-00	910	1-246-472-00	9.1k	1-246-496-00	91k	1-246-520-00	910k	1-246-544-00		

HARDWARE NOMENCLATURE

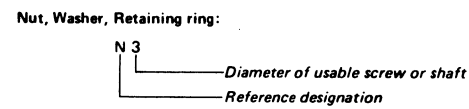
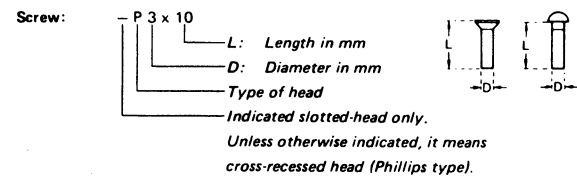

Reference Designation	Shape	Description	Remarks
SCREWS			
P		pan-head screw	binding-head (B) screw for replacement
PWH		pan-head screw with washer face	binding-head (B) screw and flat washer for replacement
PS PSP		pan-head screw with spring washer	binding-head (B) screw and spring washer for replacement
PSW PSPW		pan-head screw with spring and flat washers	binding-head (B) screw and spring and flat washers for replacement
R		round-head screw	binding-head (B) screw for replacement
K		flat-countersunk-head screw	
RK		oval-countersunk-head screw	
B		binding-head screw	
T		truss-head screw	binding-head (B) screw for replacement
F		flat-fillister-head screw	
RF		fillister-head screw	
BV		brazer-head screw	

Reference Designation	Shape	Description	Remarks
SELF-TAPPING SCREWS			
TA		self-tapping screw	ex: TA, P 3 x 10
PTP		pan-head self-tapping screw	binding-head self-tapping (TA, B) screw for replacement
PTPWH		pan-head self-tapping screw with washer face	binding-head self-tapping (TA, B) screw and flat washer for replacement
PTTWH		pan-head thread-rolling screw with washer face	binding-head (B) screw and flat washer for replacement
SET SCREWS			
SC		set screw	
SC		hexagon-socket set screw	ex: SC 2.6 x 4, hexagon socket
NUT			
N		nut	
WASHERS			
W		flat washer	
SW		spring washer	
LW		internal-tooth lock washer	ex: LW3, internal
LW		external-tooth lock washer	ex: LW3, external
RETAINING RINGS			
E		retaining ring	
G		grip-type retaining ring	

Replacement Semiconductors

For replacement, use semiconductors except in ().

Q101, 102 }
Q151, 152 } : 2SC1362 (2SC900F)
Q301, 302 }

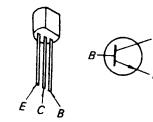

IC401, 402 }
IC451, 452 } : TL489CP

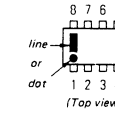

Q201, 202 }
Q251, 252 } : 2SA1027R (2SA733Q)
Q203, 253 } : 2SA1027R (2SA733P)

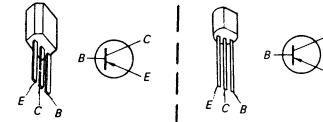

D201, 251: SV04S

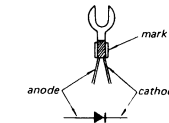

Q204, 254 }
Q501 } : 2SC1364 (2SC945P)

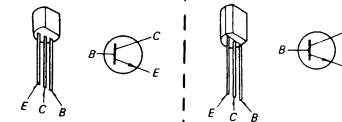

D202 : EQB01-16 (RD16EB)
D401, 402 }
D451, 452 } : 1T22AM (1S188AM)
D403, 404 }
D453, 454 } : 1S953
D501-504 : 10E2 (1N4002)

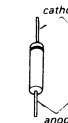

Q205, 255: 2SD414 (2SD414R)

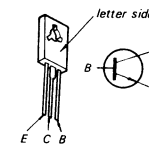

D505: S3VC40

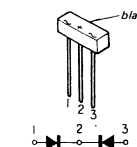

(10DC1N)

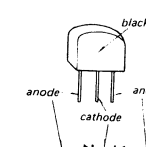

Q206, 256: 2SB548 (2SB548R)

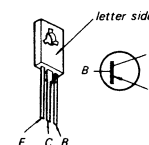

D506: S3VC40R

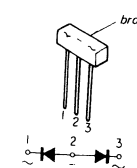

(10DC1R)

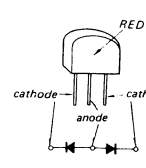

Q207, 257: 2SD586R

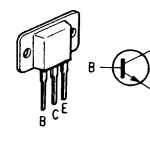

Q208, 258: 2SB616R

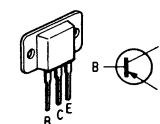

Q401, 451: 2SC1364 (2SC945Q)

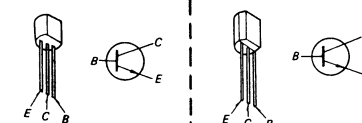

4-1. MOUNTING DIAGRAM
- Conductor Side -

Replacement Semiconductors: See page 9.

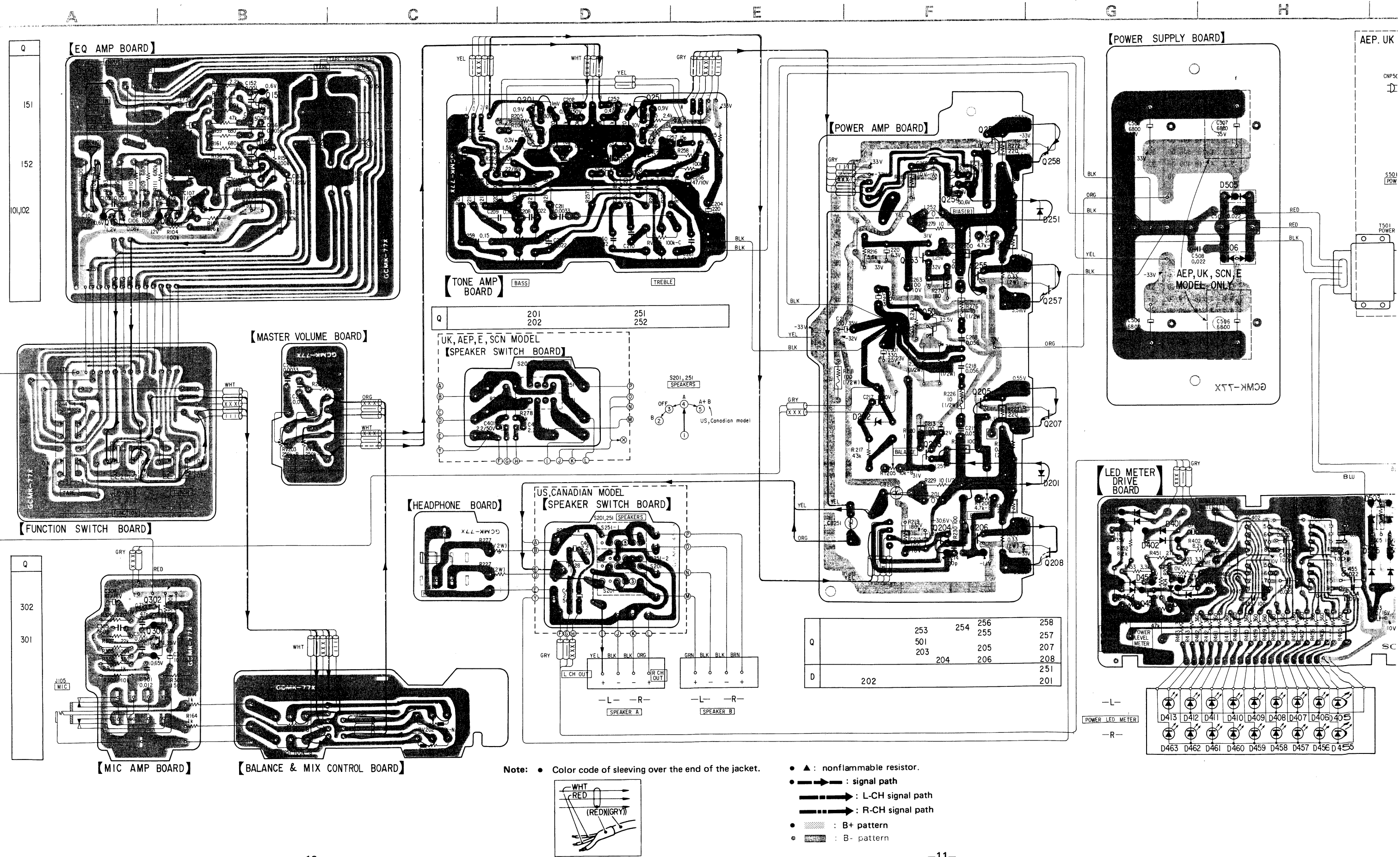

4-1. MOUNTING DIAGRAM

- Conductor Side -

Replacement Semiconductors: See page 9.

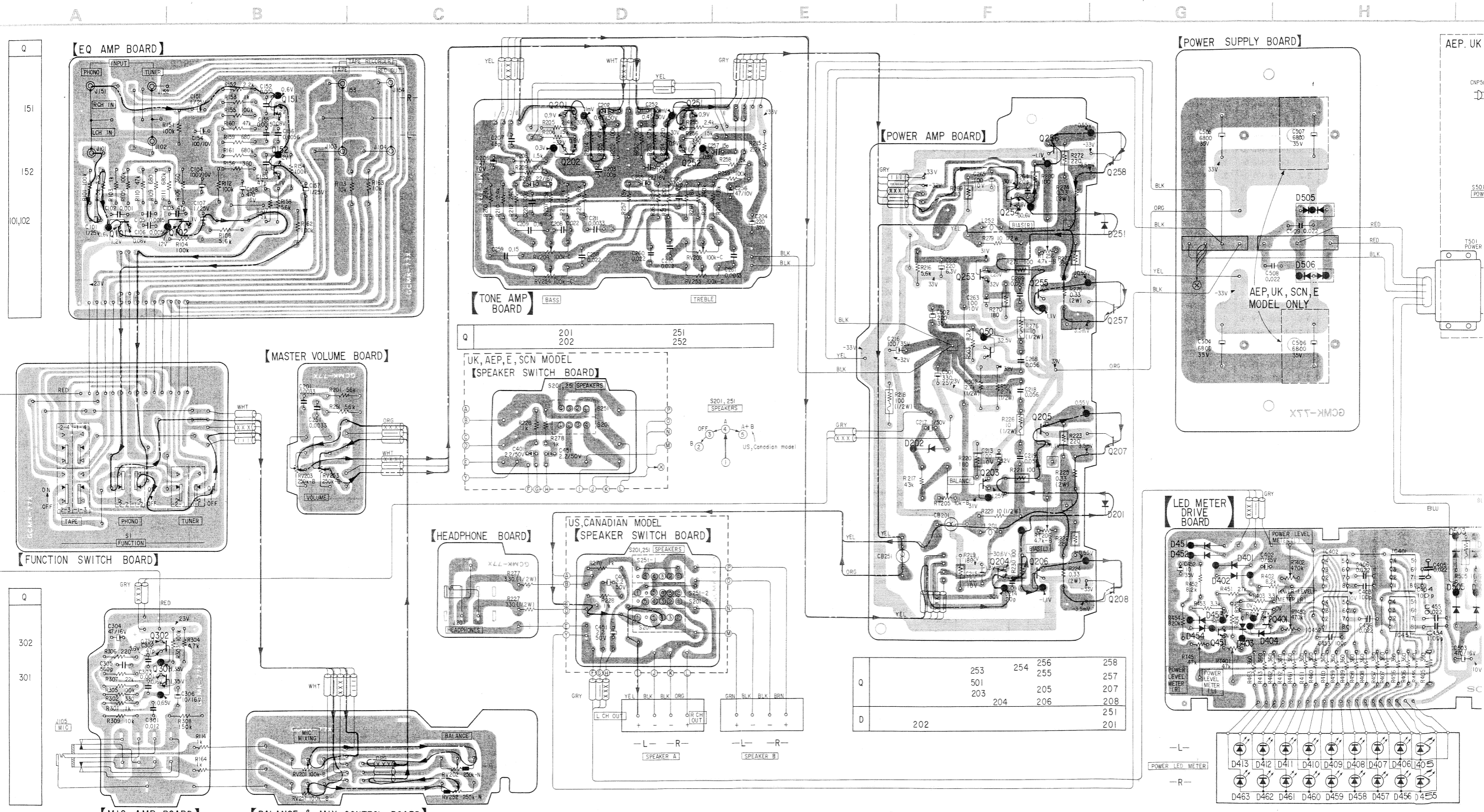

Q	201	251
	202	252

Q	253	254	256	258
	501	205	207	
	203	204	206	208
D	202			201

Note: ● Color code of sleeving over the end of the jacket.

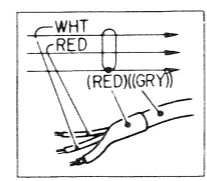

- ▲ : nonflammable resistor.
- — : signal path
- — : L-CH signal path
- — : R-CH signal path
- ■ : B+ pattern
- ■ : B- pattern

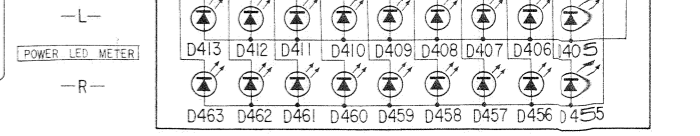
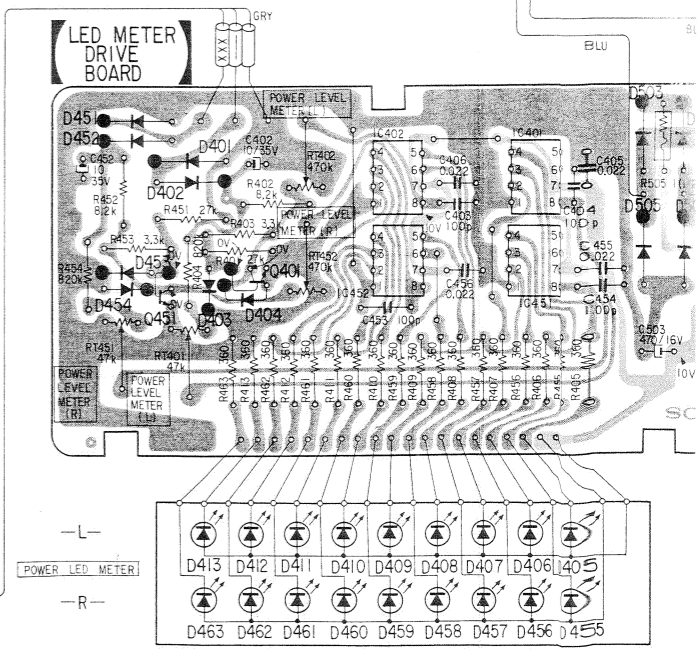

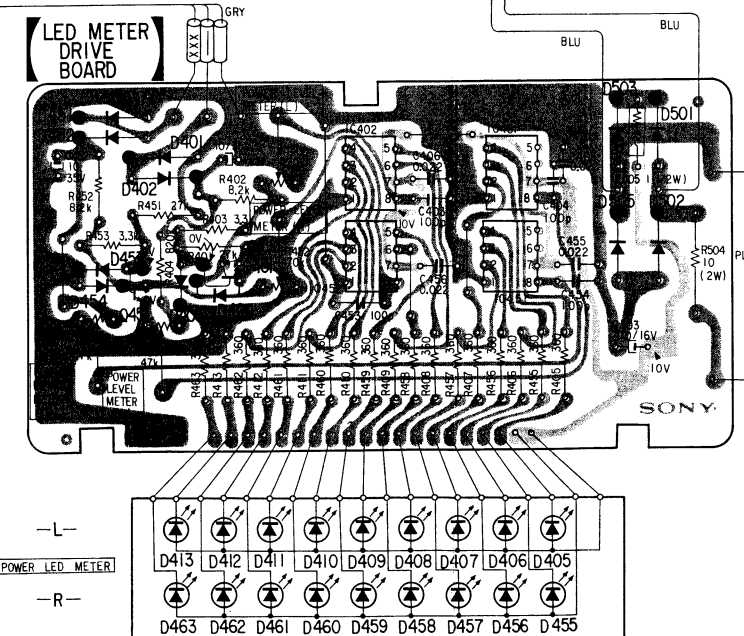
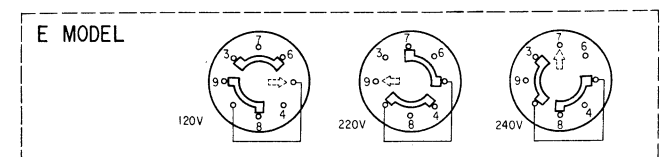
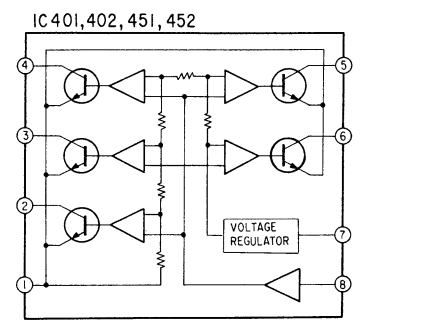
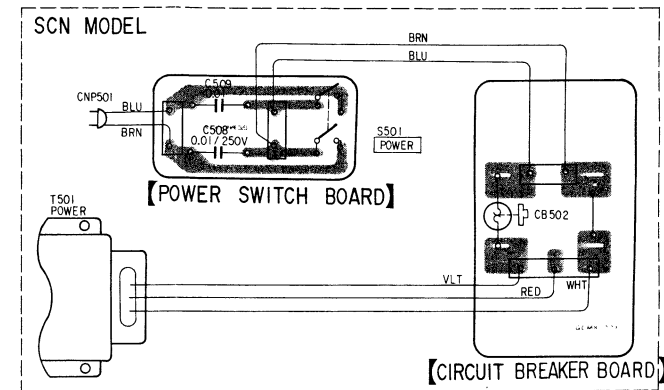
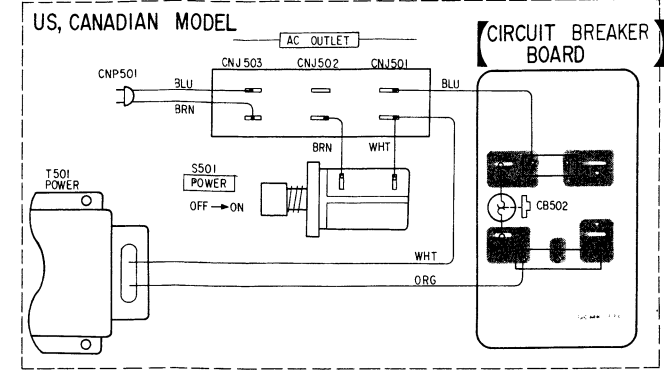
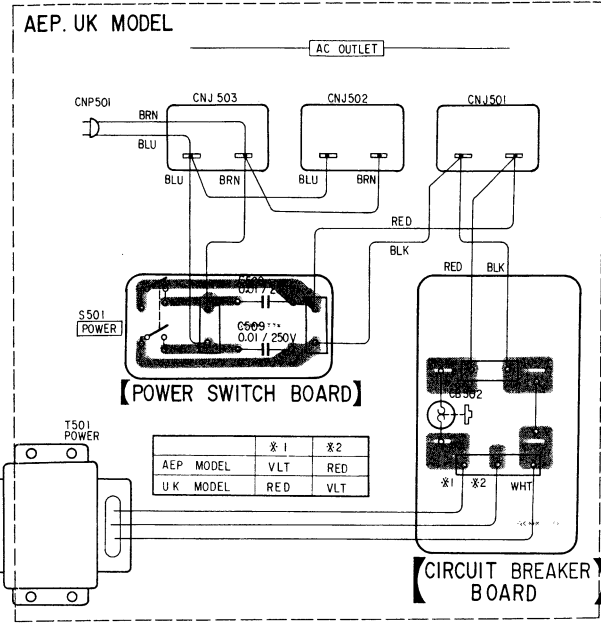
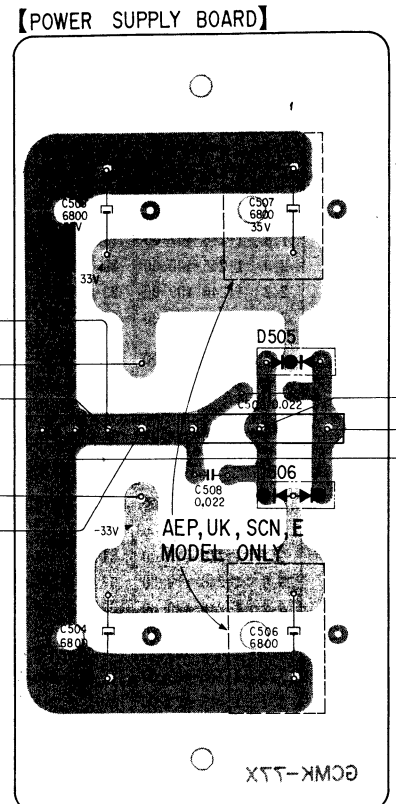
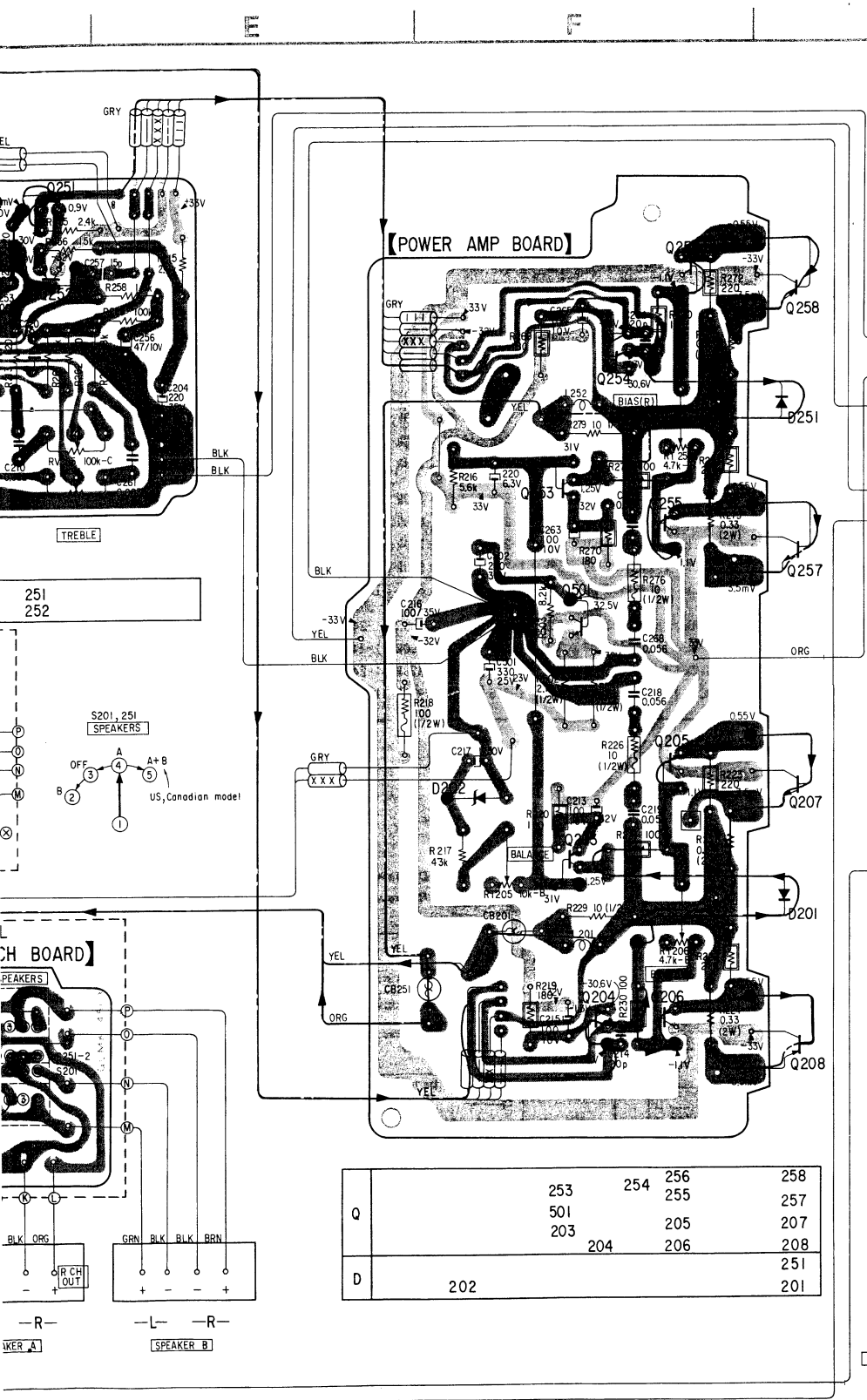

IC	Q	D
IC401	451	503
IC402	452	501
IC401	401	501
IC402	402	501
IC451	453	504
IC452	401	502
IC451	403	502
IC451	454	502
IC451	451	404

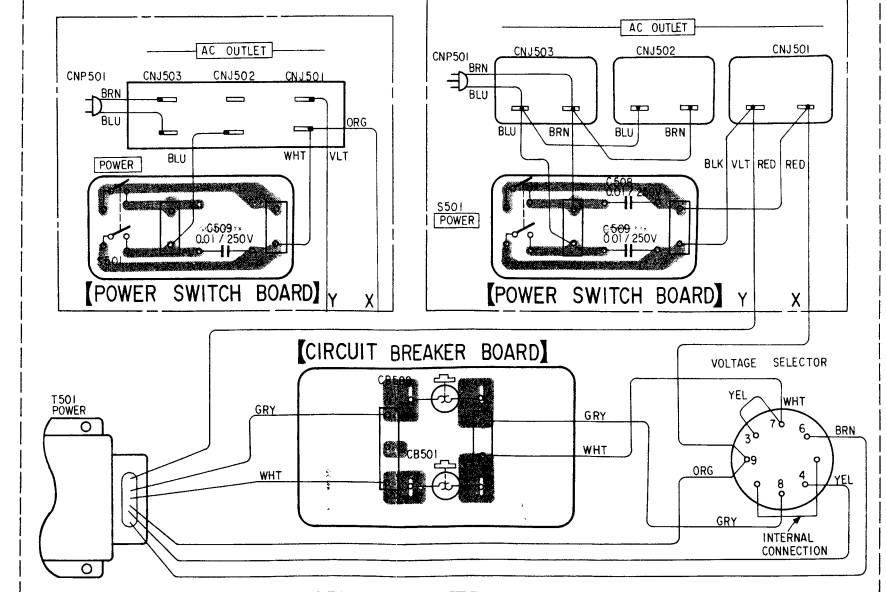

- ▲ : nonflammable resistor.
- ——— : signal path
- ——— : L-CH signal path
- ——— : R-CH signal path
- ■■■■ : B+ pattern
- ■■■■ : B- pattern

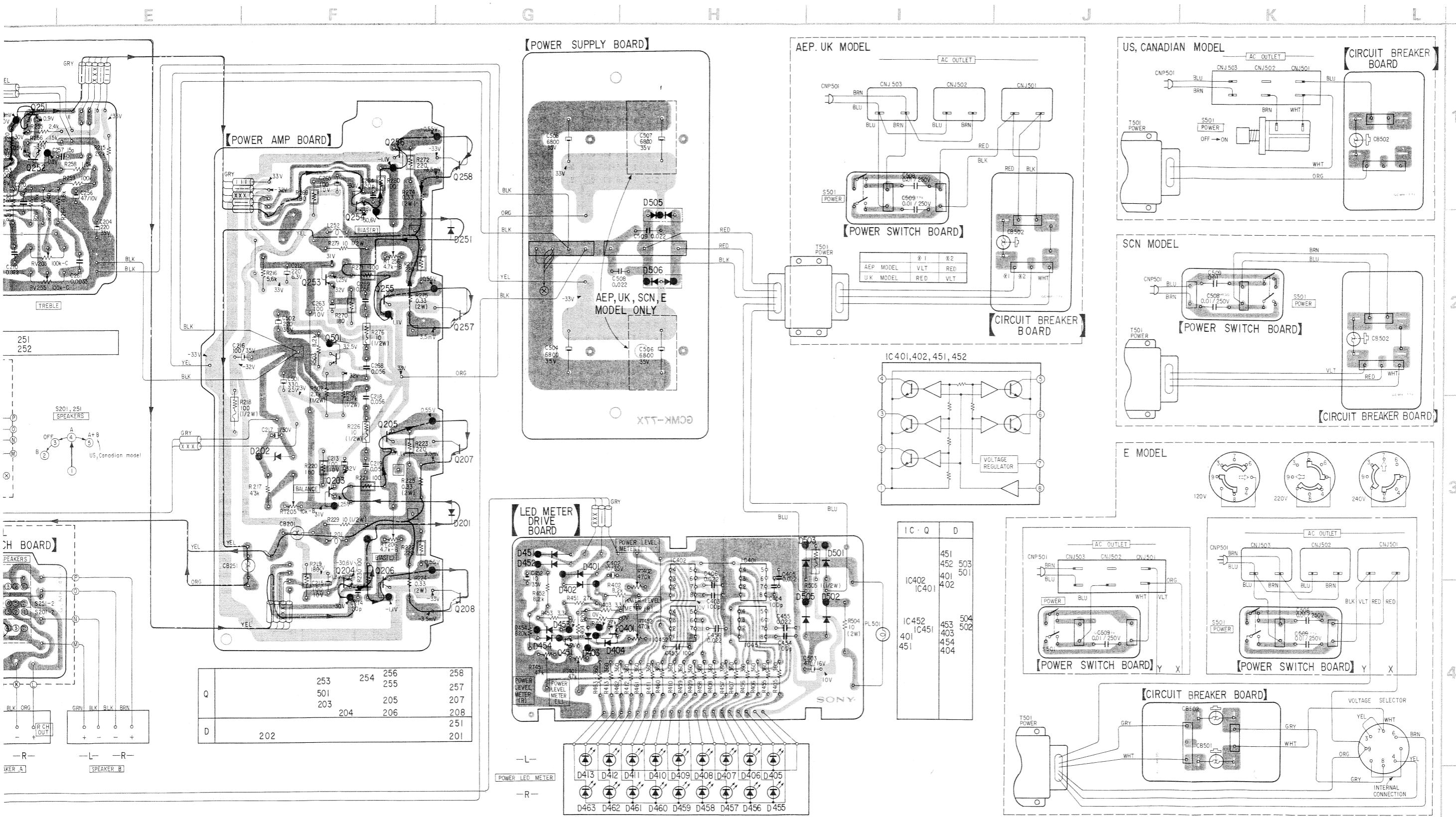

- ▲ : nonflammable resistor.
- ——— : signal path
- ——— : L-CH signal path
- ——— : R-CH signal path
- [Pattern] : B+ pattern
- [Pattern] : B- pattern

1
2
3
4
5

D E F G H I J K

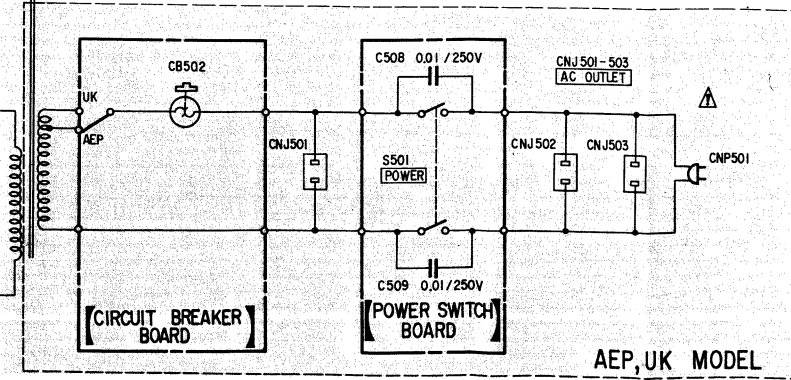
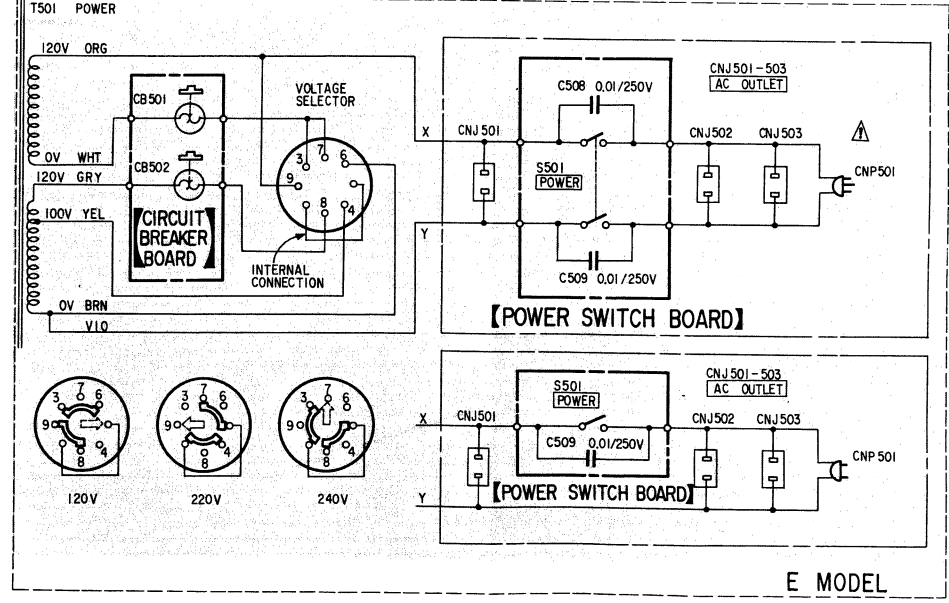
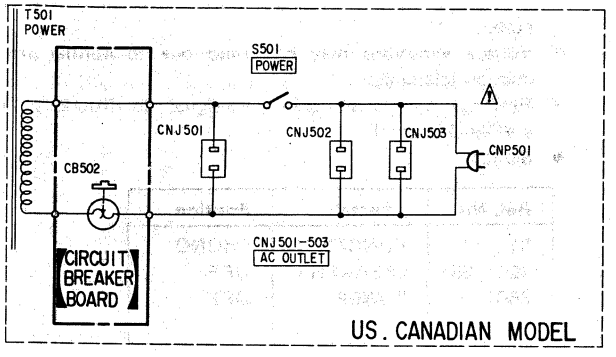
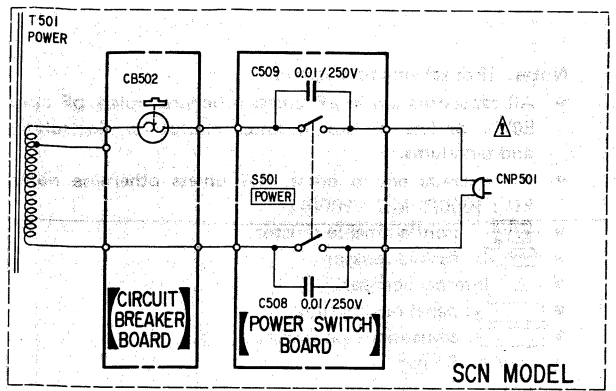
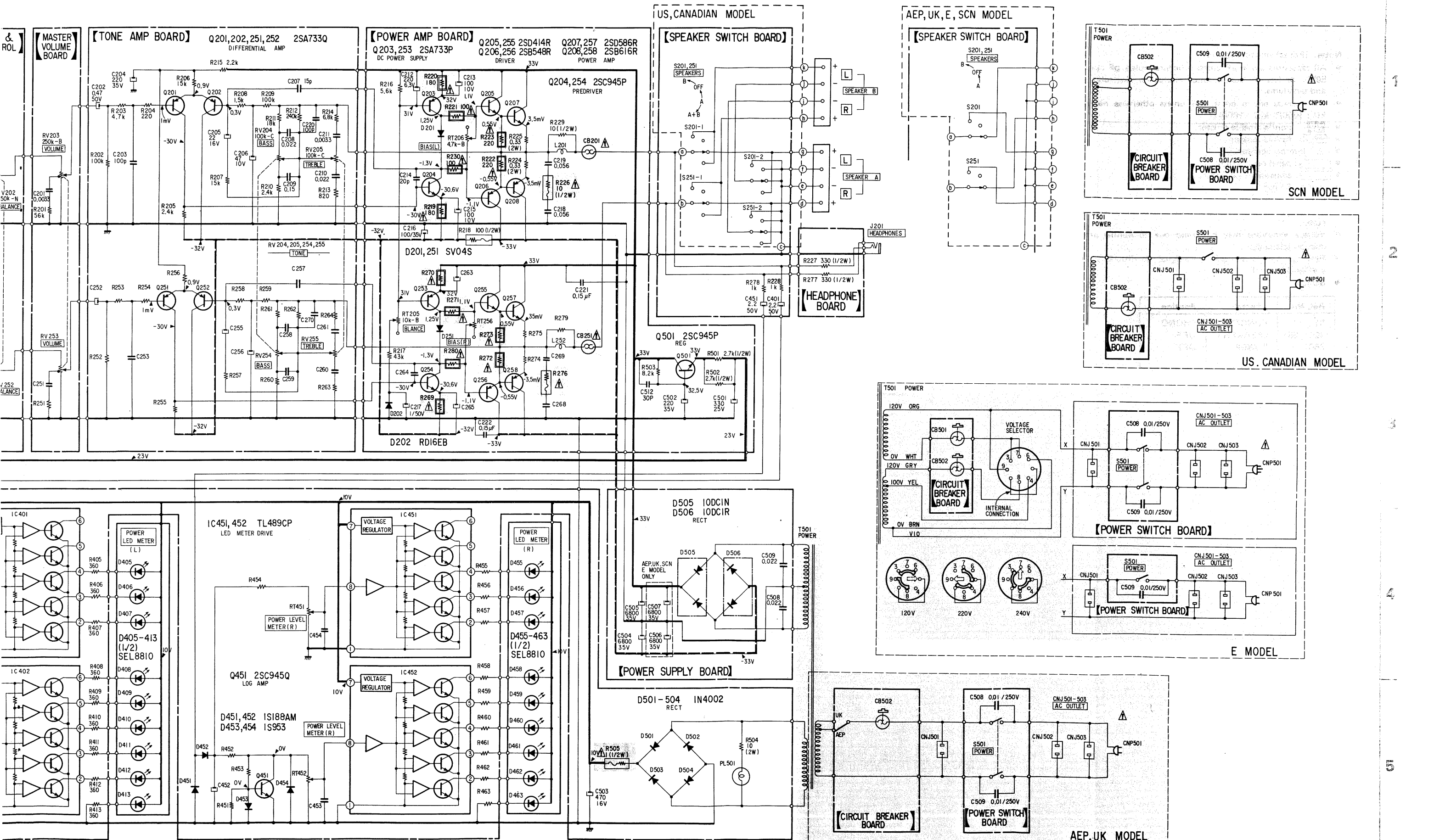

SECTION 5
EXPLODED VIEWS

Ref. No.	Switch	Position
S1	FUNCTION	PHONO
S201, 251	SPEAKERS	OFF
S501	POWER	OFF

- Notes: (For schematic diagram)
- All capacitors are in μF unless otherwise noted. pF : pF
 - 50WV or less are not indicated except for electrolytics and tantalums.
 - All resistors are in ohms, $\frac{1}{4}\text{W}$ unless otherwise noted. K Ω : 1000 Ω , M Ω : 1000K Ω
 - \square : fusible resistor.
 - Δ : internal component.
 - \square : panel designation.
 - \square : adjustment for repair.
 - \square : B+ bus.
 - \square : B- bus.
 - Voltages are dc with respect to ground unless otherwise noted.
 - Voltage variations may be noted due to normal production tolerances.
 - Readings are taken under no-signal conditions with a VOM (20K Ω/V).
 - Switch

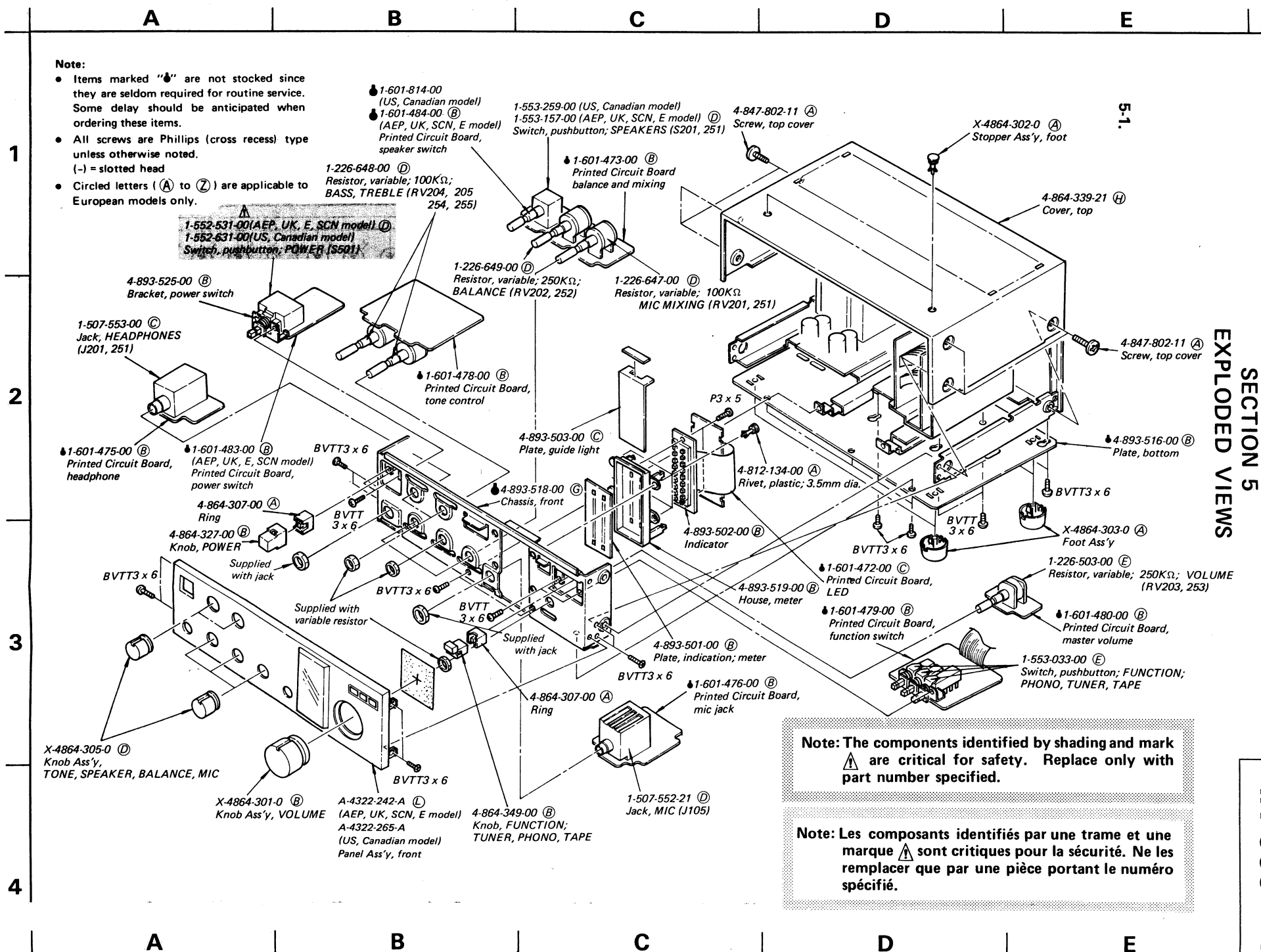

Note:

- Items marked "⚡" are not stocked since they are seldom required for routine service. Some delay should be anticipated when ordering these items.
- All screws are Phillips (cross recess) type unless otherwise noted. (-) = slotted head
- Circled letters (A) to (Z) are applicable to European models only.

Note: The components identified by shading and mark ⚡ are critical for safety. Replace only with part number specified.

Note: Les composants identifiés par une trame et une marque ⚡ sont critiques pour la sécurité. Ne les remplacer que par une pièce portant le numéro spécifié.

Note:

- Items marked "⚡" are not stocked since they are seldom required for routine service. Some delay should be anticipated when ordering these items.
- All screws are Phillips (cross recess) type

1-551-896-00 (AEP, E1 model, euro-plug) ⚡
 1-551-628-00 (US, Canadian, E2 model, parallel-blade plug) ⚡
 1-551-962-00 (UK model) ⚡
 1-551-908-00 (SCN model) ⚡

5-2.

Note:

- Items marked "⚡" are not stocked since they are seldom required for routine service. Some delay should be anticipated when ordering these items.
- All screws are Phillips (cross recess) type unless otherwise noted. (-) = slotted head
- Circled letters (A to Z) are applicable to European models only.

1
2
3
4

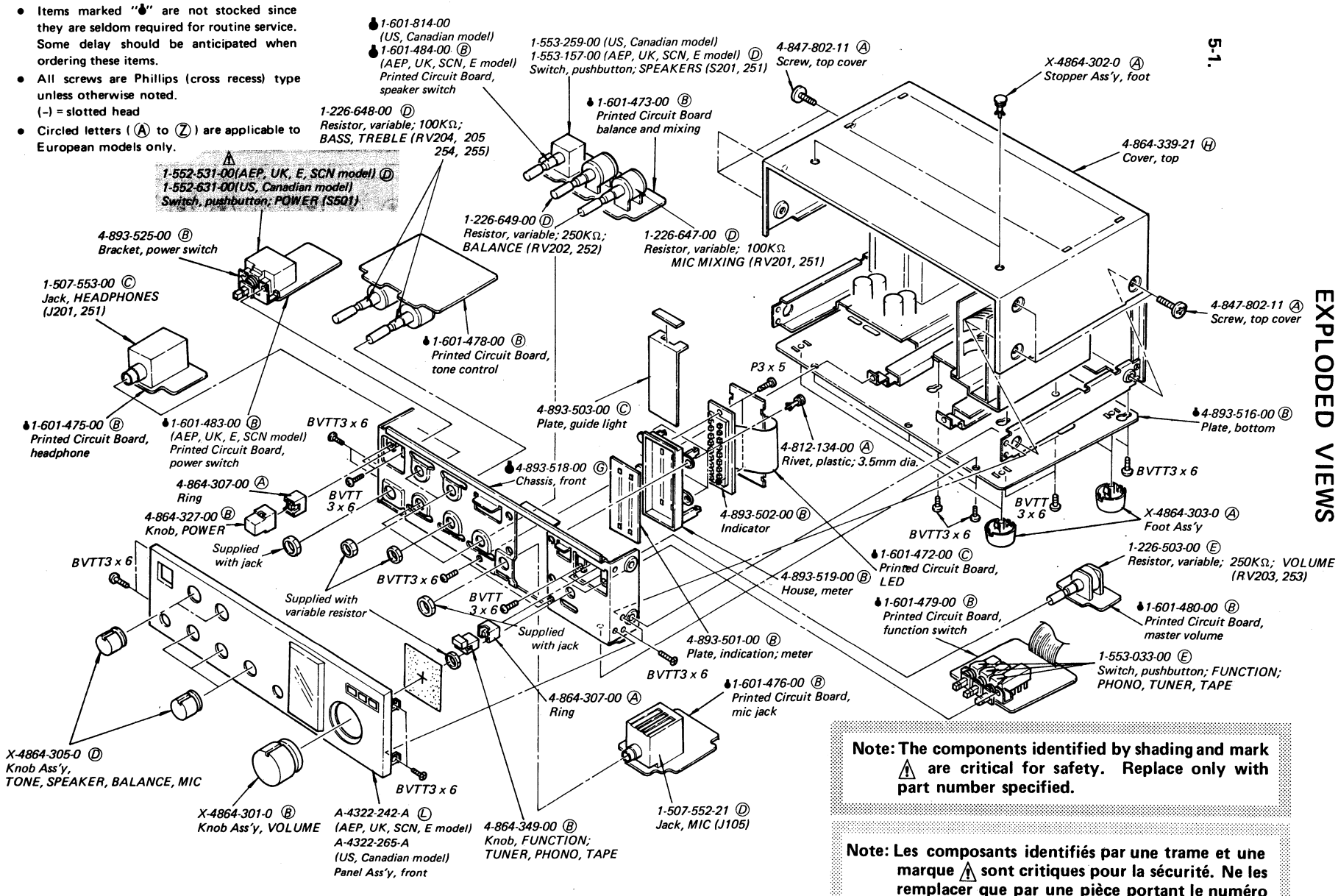

Note: The components identified by shading and mark ⚡ are critical for safety. Replace only with part number specified.

Note: Les composants identifiés par une trame et une marque ⚡ sont critiques pour la sécurité. Ne les remplacer que par une pièce portant le numéro spécifié.

Note:

- Items marked "⚡" are not stocked since they are seldom required for routine service. Some delay should be anticipated when ordering these items.
- All screws are Phillips (cross recess) type unless otherwise noted. (-) = slotted head
- Circled letters (A to Z) are applicable to European models only.

1
2
3
4

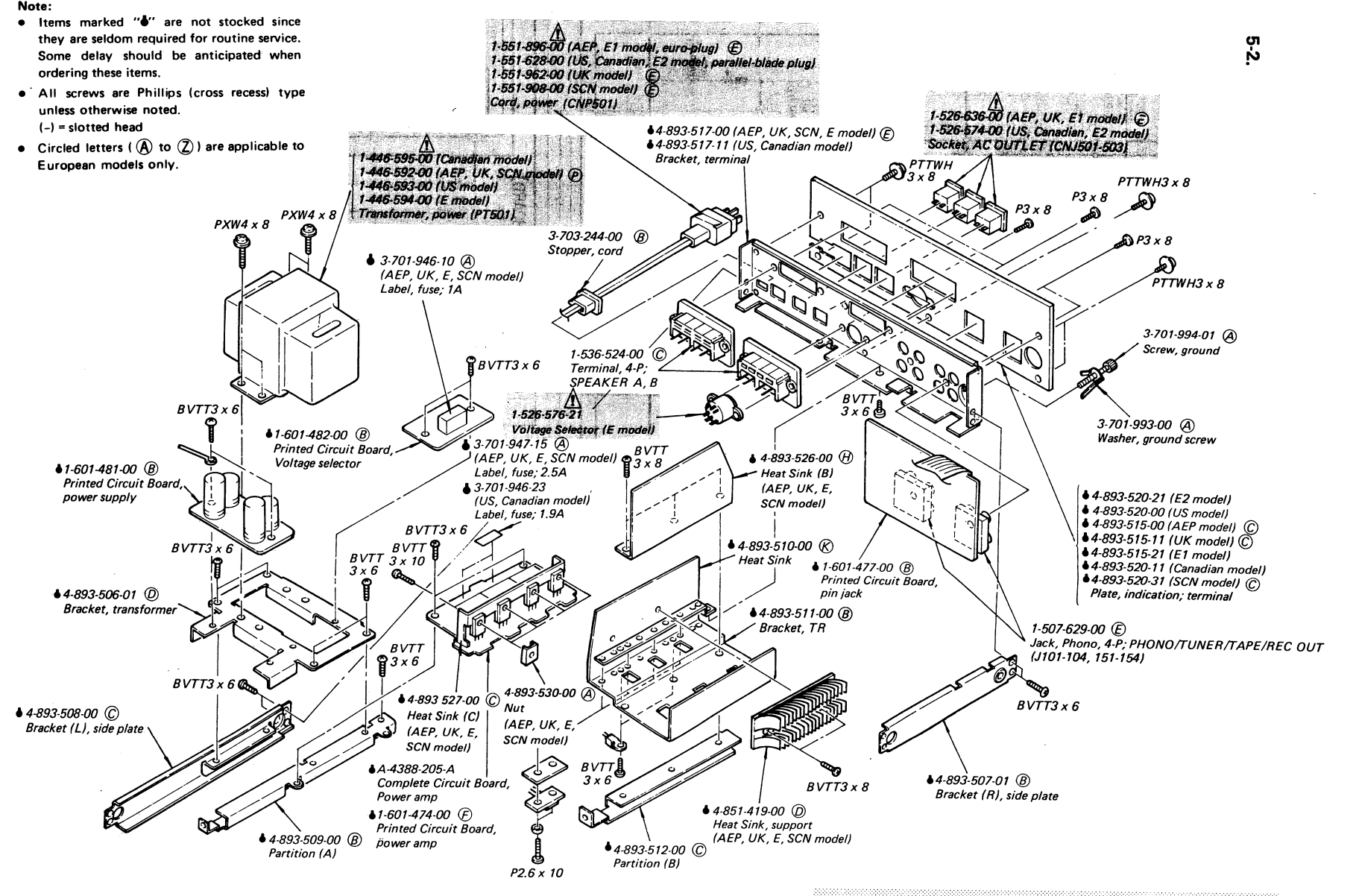

Note: Les composants identifiés par une trame et une marque ⚡ sont critiques pour la sécurité. Ne les remplacer que par une pièce portant le numéro spécifié.

Note: The components identified by shading and mark ⚡ are critical for safety. Replace only with part number specified.

5.1
5.2

SECTION 6
ELECTRICAL PARTS LIST

Note: Circled letters (A to Z) are applicable to European models only.

Ref. No.	Part No.	Description
SEMICONDUCTORS		
Transistors		
⇒ Q101, 102, Q151, 152	8-729-665-47	(B) 2SC1362
⇒ Q201, 202	8-729-612-77	(B) 2SA1027R
⇒ Q203, 253	8-729-612-77	(B) 2SA1027R
⇒ Q204, 254	8-729-663-47	(B) 2SC1364
⇒ Q205, 255	8-729-141-43	(B) 2SD414
⇒ Q206, 256	8-729-154-83	(C) 2SB548
Q207, 257	1-800-911-11	(D) 2SD586R
Q208, 258	1-800-907-11	(D) 2SB616R
⇒ Q251, 252	8-729-612-77	(B) 2SA1027R
⇒ Q301, 302	8-729-665-47	(B) 2SC1362
⇒ Q401, 451	8-719-422-21	(B) 2SC1364
Q501	8-729-663-47	(B) 2SC1364
ICs		
IC401, 402	8-759-904-89	(D) TL489CP
IC451, 452	8-759-904-89	(D) TL489CP
Diodes		
D201, 251	8-719-300-11	(C) SV04S
⇒ D202	8-719-931-16	(B) EQB01-16
⇒ D401, 402	8-719-422-21	(B) 1T22AM
D403, 404	8-719-815-55	(B) 1S953
D405-413	1-800-998-11	SEL8810
⇒ D451, 452	8-719-422-21	(B) 1T22AM
D453, 454	8-719-815-55	(B) 1S953
D455-463	1-800-998-11	SEL8810
⇒ D501-504	8-719-200-02	(B) 10E2
⇒ D505	8-719-500-34	(C) S3VC40
⇒ D506	8-719-501-34	(C) S3VC40R

CAPACITORS

All capacitors are in μF and ceramic unless otherwise noted. 50WV or less are not indicated except for electrolytics and tantalums. p : μF , elect : electrolytic

C101, 151	1-131-236-00	(B) 1	25V	tantalum
C102, 152	1-102-074-00	(A) 0.001		
C103, 153	1-101-880-00	(A) 47p		
C104, 154	1-123-307-00	(B) 100	10V	elect
C105, 155	1-108-559-00	(B) 0.0015		mylar
C106, 156	1-108-573-00	(B) 0.0056		mylar
C107, 157	1-131-236-00	(B) 1	25V	tantalum
C108	1-123-323-00	(B) 470	16V	elect
C201, 251	1-108-575-00	(B) 0.0068		mylar
C202, 252	1-121-726-00	(B) 0.47	50V	elect
C203, 253	1-102-106-00	(A) 100p		
C204	1-121-261-00	(B) 220	35V	elect
C205, 255	1-121-479-00	(B) 22	16V	elect

⇒ : Due to standardization, interchangeable replacements may be substituted for parts specified in the diagrams.

Note: The components identified by shading and mark Δ are critical for safety. Replace only with part number specified.

Ref. No.	Part No.	Description
C206, 256	1-121-352-00	(B) 47 10V elect
C207, 257	1-102-951-00	(A) 15p
C208, 258	1-108-587-00	(B) 0.022 mylar
C209, 259	1-108-607-00	(B) 0.15 mylar
C210, 260	1-108-587-00	(B) 0.022 mylar
C211, 261	1-108-567-00	(B) 0.0033 mylar
C212	1-121-419-00	(B) 220 6.3V elect
C213, 263	1-123-196-11	(B) 100 10V elect
C214, 264	1-102-958-00	(A) 20p
C215, 265	1-123-196-11	(B) 100 10V elect
C216	1-121-357-00	(B) 100 35V elect
C217	1-121-391-00	(B) 1 50V elect
C218, 268	1-108-242-00	(A) 0.022 mylar
C301	1-108-357-00	(A) 0.012 mylar
C302	1-101-880-00	(A) 47p
C303	1-102-074-00	(A) 0.001
C304	1-121-409-00	(B) 47 16V elect
C305	1-102-115-00	(A) 560p
C306	1-121-651-00	(B) 10 16V elect
C401, 451	1-121-450-00	(B) 2.2 50V elect
C402, 452	1-123-341-00	(B) 10 35V elect
C403, 453, C404, 454	1-102-106-00	(A) 100p
C405, 406	1-101-005-00	(A) 22 16V (nonpolarized)
C501	1-123-335-00	(B) 330 25V elect
C502	1-121-261-00	(B) 220 35V elect
C503	1-123-323-00	(B) 470 16V elect
C504, 505	1-125-155-00	(F) 6800 35V elect
C506, 507	1-125-155-00	(F) 6800 35V elect
(AEP, E, UK, SCN model)		
C508, 509	1-130-196-00	(D) 0.01 polyethylene

RESISTORS

All resistors are in ohms. Common $\frac{1}{4}\text{W}$ carbon resistors are omitted. Check schematic diagram for their values.

R218	Δ 1-212-982-00	(B) 100	$\frac{1}{2}\text{W}$	fusible
R219, 269	Δ 1-247-113-00	(A) 180	$\frac{1}{4}\text{W}$	carbon (nonflammable)
R220, 270	Δ 1-247-107-00	(A) 100	$\frac{1}{4}\text{W}$	carbon (nonflammable)
R221, 271	Δ 1-247-115-00	(A) 220	$\frac{1}{4}\text{W}$	carbon (nonflammable)
R222, 272	Δ 1-217-152-11	(B) 0.33	2W	metal oxide
R223, 273	Δ 1-212-958-00	(B) 10	$\frac{1}{2}\text{W}$	fusible

Note: Les composants identifiés par une tache et une marque Δ sont critiques pour la sécurité. Ne les remplacer que par une pièce portant le numéro spécifié.

Note: The components identified by shading and mark **▲** are critical for safety. Replace only with part number specified.

Note: Les composants identifiés par une trame et une marque **▲** sont critiques pour la sécurité. Ne les remplacer que par une pièce portant le numéro spécifié.

Ref. No.	Part No.	Description
R227, 277	1-244-861-00	▲ 330 ½W carbon
R229, 279	1-244-825-00	▲ 10 ½W carbon
R501, 502	1-244-883-00	▲ 2.7k ½W carbon
R504	1-206-463-11	● 10 2W metal oxide (nonflammable)
R505	▲ 1-212-934-51	● 1 ½W fusible
R230, 280	▲ 1-247-107-00	▲ 100 ¼W carbon (nonflammable)
RV201,251	1-226-647-00	● 100k, variable; MIC MIXING
RV202,252	1-226-649-00	● 250k, variable; BALANCE
RV203,253	1-226-503-00	● 250k, variable; VOLUME
RV204,254 RV205,255	1-226-648-00	● 100k, variable; BASS, TREBLE
RT205	1-226-236-00	● 10k, adjustable; balance
RT206,256	1-226-235-00	● 5k, adjustable; bias
RT401,451	1-226-238-00	● 50k, adjustable; power level meter
RT402,452	1-226-241-00	● 500k, adjustable; power level meter

SWITCHES

S1	1-553-033-00	● Function; PHONO, TUNER, TAPE
S201, 251	1-553-157-00	● Pushbutton, SPEAKERS (AEP, UK, SCN, E model)
	1-553-259-00	Pushbutton, SPEAKERS (US, Canadian model)
S501	▲ 1-552-531-00	● Pushbutton, POWER (AEP, UK, E, SCN model)
	▲ 1-552-631-00	Pushbutton, POWER (US, Canadian model)

JACKS

J101-104 J151-154	1-507-629-00	● 4P; PHONO, TUNER, TAPE
J105	1-507-552-21	● MIC
J201, 251	1-507-553-00	● HEADPHONES

MISCELLANEOUS

CB201,251	▲ 1-532-566-00	Breaker, circuit (US, Canadian model)
	▲ 1-532-567-00	● Breaker, circuit (AEP, UK, E, SCN model)
CB502	▲ 1-532-486-00	Breaker, circuit (US, Canadian model)
	▲ 1-532-535-00	● Breaker, circuit (AEP, UK, E, SCN model)
CNJ501- CNJ503	▲ 1-526-574-00	AC OUTLET (US, Canadian, E2 model)
	▲ 1-526-636-00	● AC OUTLET (AEP, UK, E1 model)
CNP501	▲ 1-551-628-00	Cord, power; parallel-blade plug (US, Canadian, E2 model)
	▲ 1-551-896-00	● Cord, power; euro-plug (AEP, E1 model)
	▲ 1-551-908-00	● Cord, power (SCN model)
	▲ 1-551-962-00	● Cord, power (UK model)

Note: Circled letters (A to Z) are applicable to European models only.

Ref. No.	Part No.	Description
L201, 252	1-420-838-00	● Coil
PT501	▲ 1-446-592-00	● Cord, power (AEP, UK, SCN model)
	▲ 1-446-593-00	Cord, power (US model)
	▲ 1-446-594-00	Cord, power (E1, E2, model)
	▲ 1-446-595-00	Cord, power (Canadian model)
	▲ A-4388-205-A	Complete Circuit Board, power amp
	▲ 1-526-576-21	● Selector, voltage (E model)
	● 1-535-114-00	● Terminal, 1P
	1-535-116-00	● Terminal, 3P
	● 1-535-117-00	● Terminal, 4P
	● 1-535-139-00	● Base Post 19mm (10mm pitch)
	1-535-140-00	● Base Post 19mm (10mm pitch)
1-536-524-00	● Terminal Board, 4P; SPEAKER A, B	
● 1-560-265-00	● Base Post (U-TYPE)	
● 1-601-472-00	● Printed Circuit Board, LED	
● 1-601-473-00	● Printed Circuit Board, balance and mixing	
● 1-601-474-00	● Printed Circuit Board, power amp	
● 1-601-475-00	● Printed Circuit Board, headphone	
● 1-601-476-00	● Printed Circuit Board, mic jack	
● 1-601-477-00	● Printed Circuit Board, pin jack	
● 1-601-478-00	● Printed Circuit Board, tone control	
● 1-601-479-00	● Printed Circuit Board, function switch	
● 1-601-480-00	● Printed Circuit Board, master volume	
● 1-601-481-00	● Printed Circuit Board, power supply	
● 1-601-482-00	● Printed Circuit Board, voltage selector	
● 1-601-483-00	● Printed Circuit Board, power switch (AEP, UK, E, SCN model)	
● 1-601-484-00	● Printed Circuit Board, speaker switch (AEP, UK, SCN, E model)	
1-601-814-00	● Printed Circuit Board, speaker switch (US, Canadian model)	

ACCESSORIES AND PACKING MATERIALS

Part No.	Description
▲ 1-551-966-00	● Adaptor, power cord (AEP, E1 model)
▲ 1-551-967-00	● Adaptor, power cord (UK model)
3-701-630-00	● Bag, plastic
3-770-993-11	● Manual, instruction (AEP, UK, E, Canadian model)
3-770-993-21	Manual, instruction (US model)
3-770-993-21	Manual, instruction (Canadian model)
3-794-577-31	
4-864-354-00	● Sheet, plastic
4-893-521-00	Carton (Canadian model)
4-893-522-00	● Carton (US, AEP, UK, E, SCN model)
4-893-533-00	● Cushion

• Items marked "●" are not stocked since they are seldom required for routine service. Some delay should be anticipated when ordering these items.

Sony Corporation

© 1979