



# TAI-SAW TECHNOLOGY CO., LTD.

No. 3, Industrial 2nd Rd., Ping-Chen Industrial District,  
Taoyuan, 324, Taiwan, R.O.C.

TEL: 886-3-4690038 FAX: 886-3-4697532

E-mail: [tstsales@mail.taisaw.com](mailto:tstsales@mail.taisaw.com) Web: [www.taisaw.com](http://www.taisaw.com)

## Approval Sheet For Product Specification

Issued Date:

Product Name: SAW Filter 1228MHz SMD 3.0×3.0mm

TST Parts No.:TA0509A

Customer Parts No.:\_\_\_\_\_

Company: _____
Division: _____
Approved by : _____
Date: _____

Checked by: \_\_\_\_\_ Elvis Chiu

Approval by: \_\_\_\_\_ Francis Chen

Date: \_\_\_\_\_ 2005/08/05



# TAI-SAW TECHNOLOGY CO., LTD.

No. 3, Industrial 2nd Rd., Ping-Chen Industrial District,  
Taoyuan, 324, Taiwan, R.O.C.

TEL: 886-3-4690038 FAX: 886-3-4697532

E-mail: [tstsales@mail.taisaw.com](mailto:tstsales@mail.taisaw.com) Web: [www.taisaw.com](http://www.taisaw.com)

## SAW Filter 1228 MHz

MODEL NO.: TA0509A

REV. NO.:1

### A. MAXIMUM RATING:

1. Input Power Level: 5 dB<sub>m</sub>
2. DC voltage: 3 V
3. Operating Temperature: -30°C to 85°C
4. Storage Temperature: -40°C to +85°C

RoHS Compliant  
Lead free  
Lead-free soldering

### B. CHARACTERISTICS:

Terminating source impedance:  $Z_S=50\Omega$

Terminating load impedance:  $Z_L=50\Omega$  (balanced)

Item	Unit	Min.	Typ.	Max.	
Center Frequency	MHz	-	1228	-	
Insertion Loss 1218 ~ 1238 MHz	dB	-	3.4	4.4	
Ripple 1218 ~ 1238 MHz	dB	-	0.9	1.7	
Absolute Attenuation					
1 ~ 1088	MHz	dB	40	52	-
1088 ~ 1178	MHz	dB	32	50	-
1178 ~ 1190	MHz	dB	15	50	-
1268 ~ 1288	MHz	dB	13	29	-
1288 ~ 1378	MHz	dB	30	41	-
1378 ~ 1480	MHz	dB	36	54	-
1480 ~ 2500	MHz	dB	28	47	-
2500 ~ 4000	MHz	dB	13	20	-

### C. TRANSFER FUNCTION :

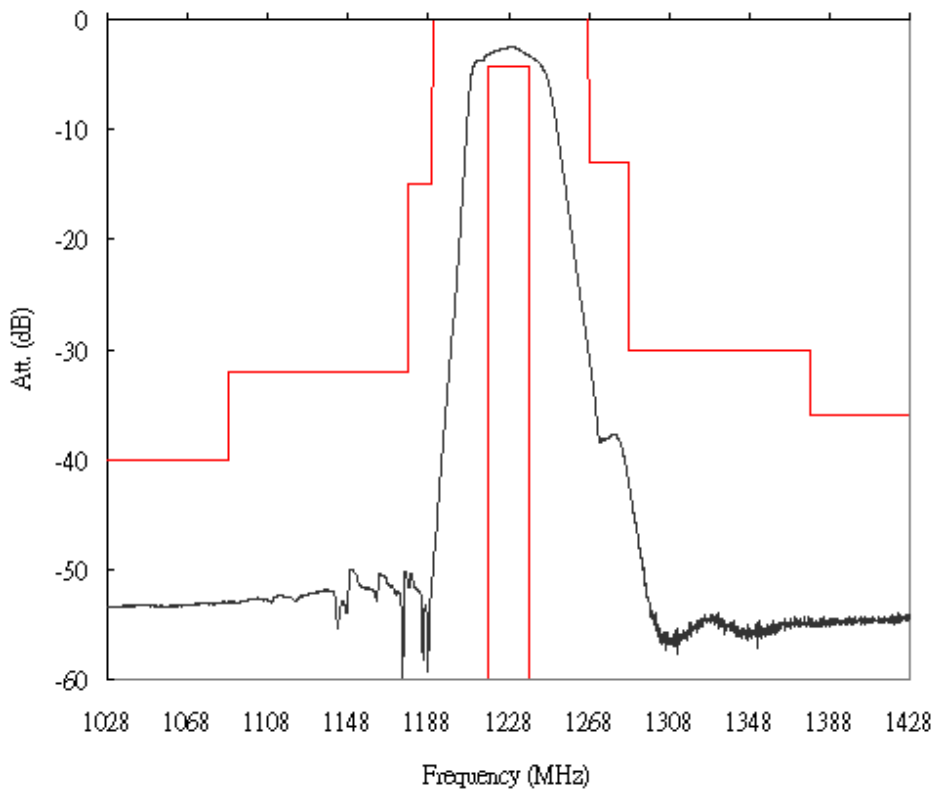
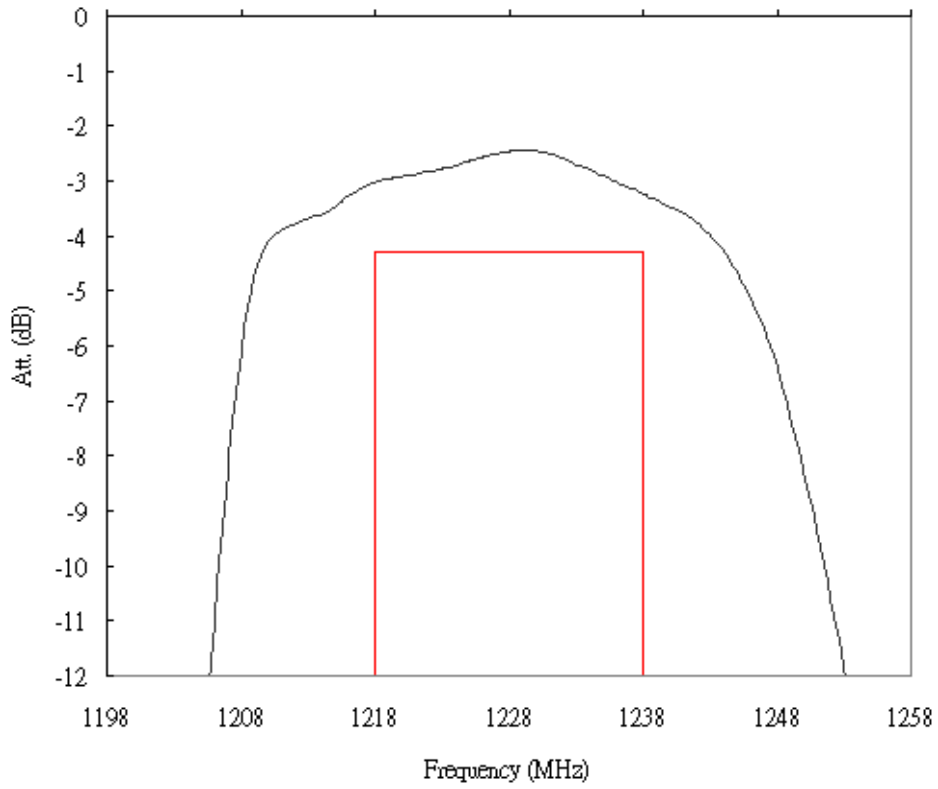

wideband

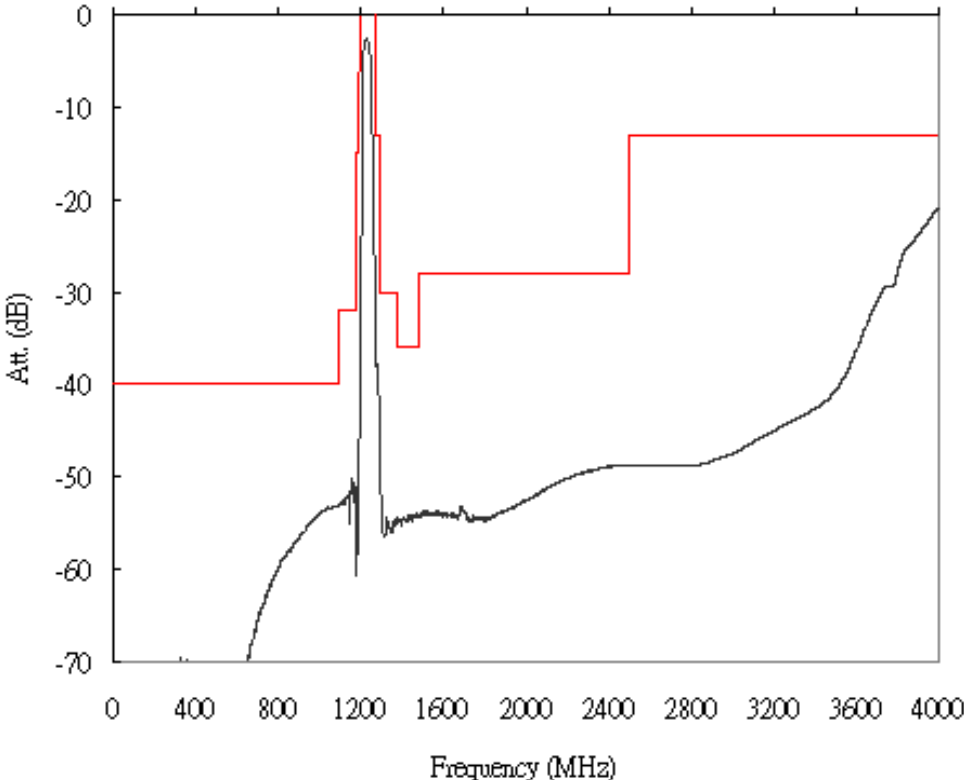

**D.MEASUREMENT CIRCUIT::**

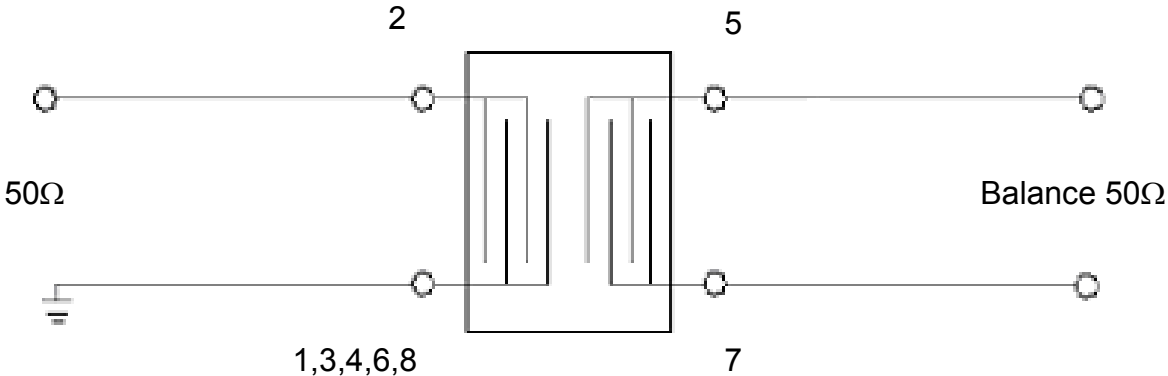

**E.OUTLINE DRAWING:**

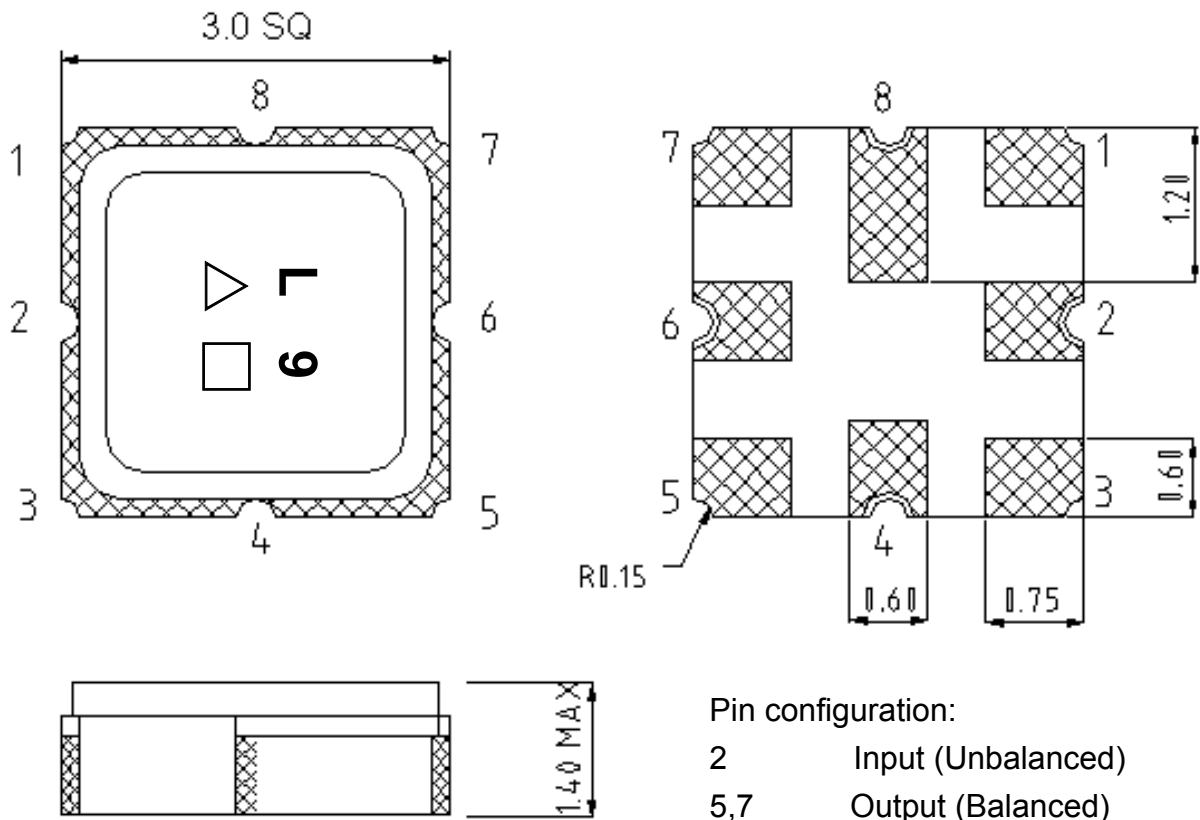

Pin configuration:

2 Input (Unbalanced)

5,7 Output (Balanced)

1,3,4,6,8 Ground

△ : Year Code

□: Date Code

**F.PCB FOOTPRINT:**

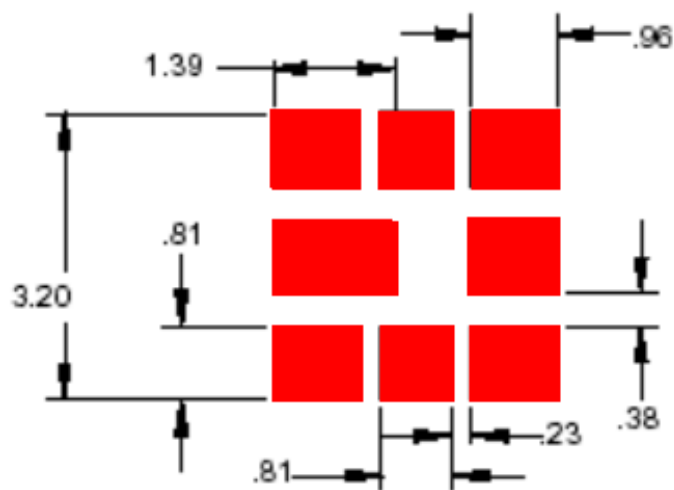

## G. PACKING:

### 1. REEL DIMENSION

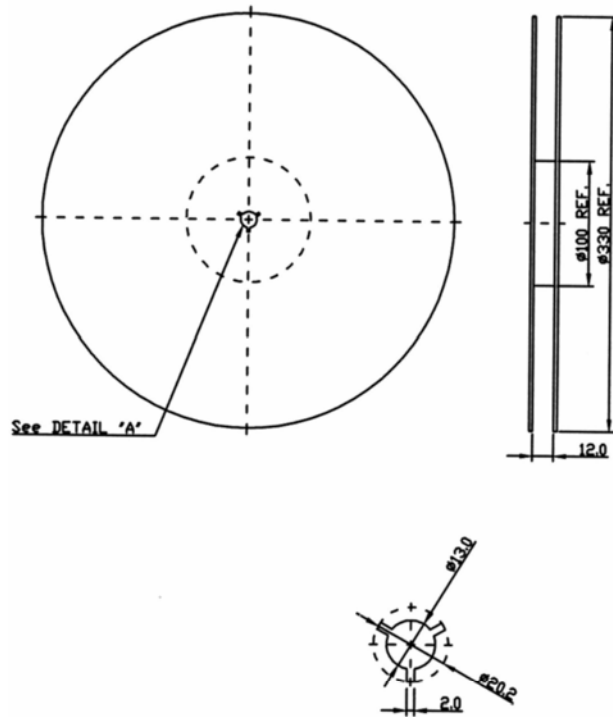

### 2. TAPE DIMENSION

