

TOSHIBA BIPOLAR LINEAR INTEGRATED CIRCUIT SILICON MONOLITHIC

TA1216AN

TV-AUDIO PROCESSOR IC

TA1216AN incorporates the following : 3-channel (left, right, woofer) signal processor circuit, I / O ports for controlling multiplex sound demodulator IC, I / O ports for controlling surround IC. The IC comes in a 30-pin shrink DIP plastic package.

Using the IC facilitates volume control for channels, level adjustment, and control of multiplex sound demodulator IC and control of surround IC.

The I²C bus controls the functions of the IC.

FEATURES

- Sound processor circuit
 - Volume control
 - Balance adjustment
 - Bass adjustment
 - Treble adjustment
 - Built-in woofer low-pass filter
- I / O port circuits
 - Circuit for controlling multiplex sound IC
 - Circuit for controlling surround IC
- I²C bus circuit
 - Adjusts filters using bus line

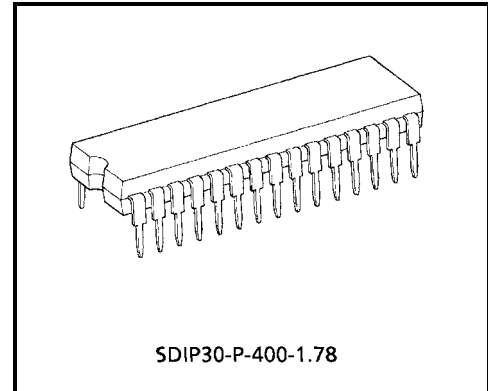

Weight: 1.99 g (Typ.)

000707EBA1

- TOSHIBA is continually working to improve the quality and reliability of its products. Nevertheless, semiconductor devices in general can malfunction or fail due to their inherent electrical sensitivity and vulnerability to physical stress. It is the responsibility of the buyer, when utilizing TOSHIBA products, to comply with the standards of safety in making a safe design for the entire system, and to avoid situations in which a malfunction or failure of such TOSHIBA products could cause loss of human life, bodily injury or damage to property.
In developing your designs, please ensure that TOSHIBA products are used within specified operating ranges as set forth in the most recent TOSHIBA products specifications. Also, please keep in mind the precautions and conditions set forth in the "Handling Guide for Semiconductor Devices," or "TOSHIBA Semiconductor Reliability Handbook" etc..
- The TOSHIBA products listed in this document are intended for usage in general electronics applications (computer, personal equipment, office equipment, measuring equipment, industrial robotics, domestic appliances, etc.). These TOSHIBA products are neither intended nor warranted for usage in equipment that requires extraordinarily high quality and/or reliability or a malfunction or failure of which may cause loss of human life or bodily injury ("Unintended Usage"). Unintended Usage include atomic energy control instruments, airplane or spaceship instruments, transportation instruments, traffic signal instruments, combustion control instruments, medical instruments, all types of safety devices, etc.. Unintended Usage of TOSHIBA products listed in this document shall be made at the customer's own risk.
- The products described in this document are subject to the foreign exchange and foreign trade laws.
- The information contained herein is presented only as a guide for the applications of our products. No responsibility is assumed by TOSHIBA CORPORATION for any infringements of intellectual property or other rights of the third parties which may result from its use. No license is granted by implication or otherwise under any intellectual property or other rights of TOSHIBA CORPORATION or others.
- The information contained herein is subject to change without notice.

BLOCK DIAGRAM

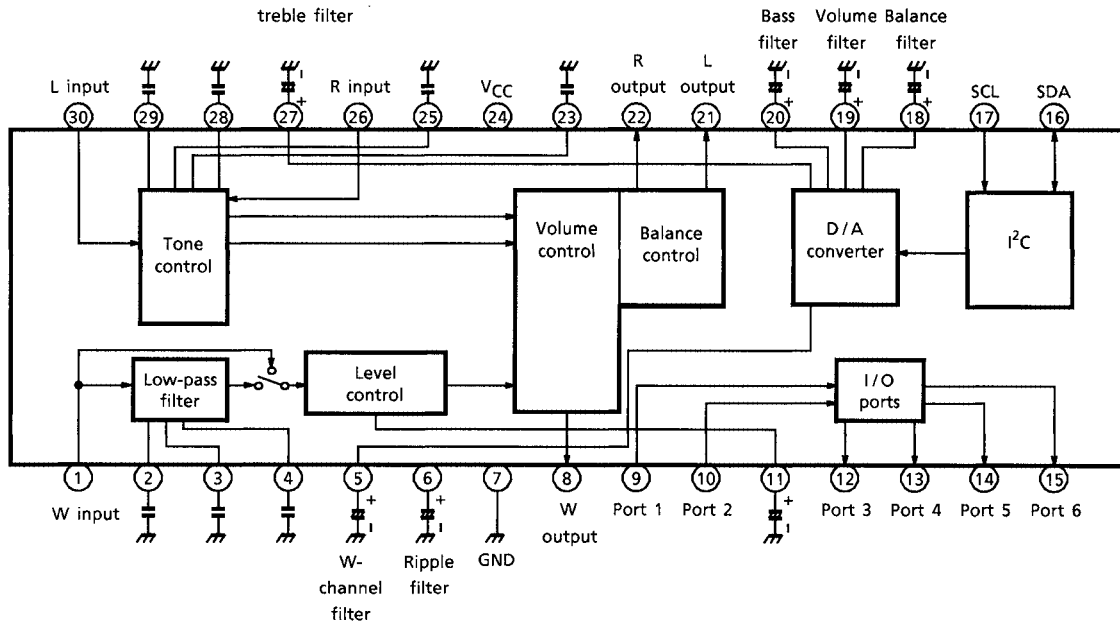

PIN FUNCTION

PIN No.	PIN NAME	FUNCTION	INTERFACE CIRCUIT
1	W-channel input	Audio signal input pin. Inputs woofer signal. Connect 1000pF capacitor between this pin and GND to prevent oscillation.	
2 3 4	W-channel LPF	Pins for connecting external capacitors for W-channel signal LPF.	
5 19	W-channel filter Volume filter	Pins for connecting capacitors to smooth control current.	
6	Ripple filter	Pins for connecting capacitor to reject ripples in supply voltage of 9V.	

PIN No.	PIN NAME	FUNCTION	INTERFACE CIRCUIT
7	GND	GND pin	—
8 21 22	W-channel output L-channel output R-channel output	Output pins for audio signal.	
9 10	Input ports	Pins for outputting signals to microcontroller by I ² C bus.	
11	W-channel offset filter	Pins for rejecting offset of woofer channel.	
12 13 14	Output ports	Switches controlled by I ² C bus. Open collector output.	

PIN No.	PIN NAME	FUNCTION	INTERFACE CIRCUIT
15	Output port	Switch controlled by I ² C bus. Ternary output.	
16	SDA	I ² C bus SDA pin	
17	SCL	I ² C bus SCL pin	
18	Balance filter	Pin for connecting capacitor to smooth control current.	

PIN No.	PIN NAME	FUNCTION	INTERFACE CIRCUIT
20 27	Bass filter Treble filter	Pins for connecting capacitors to smooth control current.	
23 28	R-channel LPF L-channel LPF	Pins for connecting external capacitors for bass control LPF for R- and L-channel signal.	
25 29	R-channel HPF L-channel HPF	Pins for connecting external capacitors for treble control HPF for R- and L-channel signal.	
26 30	R-channel input L-channel input	Audio signal input pins. Input R- and L-channel signals.	
24	V _{CC}	Power pin. Recommended supply voltage is 9V.	—

I²C BUS CONTROL MAP
WRITE MODE
SLAVE ADDRESS : 80H

SUB ADDRESS	CONTROL SIGNAL ARRAY CONTENTS								INITIAL VALUE
	7	6	5	4	3	2	1	0	
00H	(*)	Bass adjustment							32H (center)
01H	(*)	Treble adjustment							32H (center)
02H	(*)	Volume adjustment							00H (minimum)
03H	(*)	(*)	(*)	(*)	(*)	(*)	(*)	(*)	—
04H	(*)	W-channel level adjustment							00H (minimum)
05H	(*)	Balance adjustment							32H (center)
06H	(*)	(*)	Port 6	Port 5	Port 4	Port 3	(*)	20H	
07H	(*)	(*)	WFC	(*)	WLS	MT2	MT1	10H	

*: Unusable

READ MODE
SLAVE ADDRESS : 81H

POR	(*)	(*)	(*)	(*)	(*)	(*)	Port 2	Port 1	—
-----	-----	-----	-----	-----	-----	-----	--------	--------	---

*: Unusable

BUS CONTROL FUNCTIONS

Write mode

- Sub address----- 06H (I / O port control)
 - Port 3 ----- 1 : Low
0 : High
 - Port 4 ----- 1 : Low
0 : High
 - Port 5 ----- 1 : Low
0 : High
 - Port 6 ----- 01 : 2.5V
10 : 0.7V
11 : 5.0V
- Sub address----- 07H (Woofers control and others)
 - WFC (Woofers fc control)-----00 : 60Hz
01 : 80Hz
10 : 100Hz
11 : 120Hz
 - WLS (Woofers LFP switch)-----1 : LPF off
0 : LPF on
 - MT1 (Mute 1)-----1 : All mute
0 : Mute off
 - MT2 (Mute 2)-----1 : W-channel mute
0 : Mute off

Read mode

- Port 1 ----- High : 0
Low : 1
- Port 2 ----- High : 0
Low : 1
- POR (power-on reset)-----1 : Reset

MAXIMUM RATINGS

CHARACTERISTIC	SYMBOL	RATING	UNIT
Supply Voltage	V_{CCmax}	14.0	V
Power Dissipation	P_D	1560	mW
Operating Temperature	T_{opr}	-20~65	°C
Storage Temperature	T_{stg}	-55~150	°C

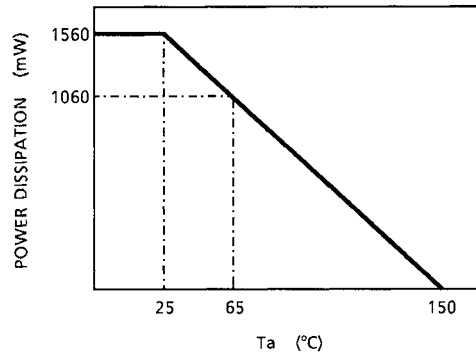

POWER SUPPLY (Pin 24)

CHARACTERISTIC	SYMBOL	MIN	TYP.	MAX	UNIT	REMARKS
Collector Supply Voltage	V_{CC}	—	9.0	—	V	—
Current Dissipation	I_{CC}	35.0	48.2	65	mA	At power-on reset
Power Dissipation	P_C	315	434	585	mW	At power-on reset

ELECTRICAL CHARACTERISTICS

DC CHARACTERISTICS

Pin voltage

PIN No.	PIN NAME	SYMBOL	TEST CIR-CUIT	MIN	TYP.	MAX	UNIT	REMARKS
1	Woofers input	V1	—	4.4	4.9	5.4	V	—
2	W-channel LPF	V2	—	5.1	5.6	6.1	V	—
3	W-channel LPF	V3	—	5.1	5.6	6.1	V	—
4	W-channel LPF	V4	—	5.1	5.6	6.1	V	—
5	Woofers filter	V5	—	—	0.0	—	V	W-channel level = 00H
6	Ripple filter	V6	—	5.1	5.6	6.1	V	—
7	GND	V7	—	—	—	—	V	—
8	Woofers output	V8	—	3.7	4.2	4.7	V	At power-on reset
9	Input port	V9	—	—	—	—	V	—
10	Input port	V10	—	—	—	—	V	—
11	W-channel offset filter	V11	—	4.4	4.9	5.4	V	—
12	Output port	V12	—	—	—	—	V	Open collector output
13	Output port	V13	—	—	—	—	V	Open collector output
14	Output port	V14	—	—	—	—	V	Open collector output

PIN No.	PIN NAME	SYMBOL	TEST CIR-CUIT	MIN	TYP.	MAX	UNIT	REMARKS
15	Output port	V15	—	—	—	0.5	V	Ternary output (at low output)
16	SDA	V16	—	—	—	—	V	—
17	SCL	V17	—	—	—	—	V	—
18	Balance filter	V18	—	4.4	4.9	5.4	V	Balance = 32H
19	Volume filter	V19	—	—	0.0	—	V	Volume = 00H
20	Bass filter	V20	—	4.4	4.9	5.4	V	Bass = 32H
21	L-channel output	V21	—	3.7	4.2	4.7	V	At power-on reset
22	R-channel output	V22	—	3.7	4.2	4.7	V	At power-on reset
23	R-channel LP	V23	—	4.4	4.9	5.4	V	—
24	V _{CC}	V24	—	—	9.0	—	V	—
25	R-channel HPF	V25	—	4.4	4.9	5.4	V	—
26	R-channel input	V26	—	4.4	4.9	5.4	V	—
27	Treble filter	V27	—	4.4	4.9	5.4	V	Treble = 32H
28	L-channel LPF	V28	—	4.4	4.9	5.4	V	—
29	L-channel HPF	V29	—	4.4	4.9	5.4	V	—
30	L-channel input	V30	—	4.4	4.9	5.4	V	—

ELECTRICAL MEASUREMENT

CHARACTERISTIC		SYMBOL	TEST CIR-CUIT	TEST CONDITION	TEST PIN	MIN	TYP.	MAX	UNIT
Gain	Gv.L	—	(Note 1)	Pin 21	-0.2	1.8	3.8	dB	
	Gv.R			Pin 22					
	Gv.W			Pin 8					
Total Harmonic Distortion	THD.L	—	(Note 2)	Pin 21	—	0.25	1.1	%	
	THD.R			Pin 22					
	THD.W			Pin 8					
S / N	SN.L	—	(Note 3)	Pin 21	—	—	-70	dB	
	SN.R			Pin 22					
	SN.W			Pin 8					
Residual Noise	V _{NO} .L	—	(Note 4)	Pin 21	—	—	50	μV _{p-p}	
	V _{NO} .R			Pin 22					
	V _{NO} .W			Pin 8					
Frequency Characteristic (100Hz)	FC _L .L	—	(Note 5)	Pin 21	-2	0	2	dB	
	FC _L .R			Pin 22					
Frequency Characteristic (10kHz)	FC _H .L	—	(Note 6)	Pin 21	-2	0	2	dB	
	FC _H .R			Pin 22					
LPF Frequency Characteristic (160Hz)	fc = 60Hz	FC ₀ .W1	—	(Note 7)	Pin 8	-10.5	-7.5	-4.5	dB
	fc = 80Hz	FC ₀ .W2				-8	-5	-2	
	fc = 100Hz	FC ₀ .W3				-7	-4	-1	
	fc = 120Hz	FC ₀ .W4				-16	-9	-1	
Balance Center	ΔV _{L-R}	—	(Note 8)	Pin 21 Pin 22	-2	0	2	dB	

CHARACTERISTIC	SYMBOL	TEST CIR-CUIT	TEST CONDITION	TEST PIN	MIN	TYP.	MAX	UNIT
Balance Minimum	V_{LMIN}	—	(Note 9)	Pin 21	—	—	-60	dB
	V_{RMIN}			Pin 22				
Treble Maximum	V_{TMAXL}	—	(Note 10)	Pin 21	6.0	8.0	10.0	dB
	V_{TMAXR}			Pin 22				
Treble Minimum	V_{TMINL}	—	(Note 11)	Pin 21	-10.0	-8.0	-6.0	dB
	V_{TMINR}			Pin 22				
Bass Maximum	V_{BMAXL}	—	(Note 12)	Pin 21	6.0	8.0	10.0	dB
	V_{BMAXR}			Pin 22				
Bass Minimum	V_{BMINL}	—	(Note 13)	Pin 21	-10.0	-8.0	-6.0	dB
	V_{BMINR}			Pin 22				
Volume Center	V_{VCENL}	—	(Note 14)	Pin 21	-18	-16	-13	dB
	V_{VCENR}			Pin 22				
	V_{VCENW}			Pin 8				
Level Center	V_{LCENW}	—	(Note 15)	Pin 8	-9.0	-7.0	-5.0	dB
Residual Noise	$V_{M.L}$	—	(Note 16)	Pin 21	—	—	100	μV_{p-p}
	$V_{M.R}$			Pin 22				
	$V_{M.W}$			Pin 8				
Cross Talk	CR_{L-R}	—	(Note 17)	Pin 22	—	—	80	dB
	CR_{R-L}			Pin 21				
	CR_{L-W}			Pin 8				
	CR_{R-W}			Pin 8				
	CR_{W-R}			Pin 22				
	CR_{W-L}			Pin 21				
Ripple Rejection Ratio (Minimum Volume)	RR.L	—	(Note 18)	Pin 21	—	—	-30	dB
	RR.R			Pin 22				
Ripple Rejection Ratio (Maximum Volume)	RR'.L	—	(Note 19)	Pin 21	—	—	-30	dB
	RR'.R			Pin 22				
Output Dynamic Range	$V_{OUT.L}$	—	(Note 20)	Pin 21	6.5	—	—	V
	$V_{OUT.R}$			Pin 22				
	$V_{OUT.W}$			Pin 8				
Input Dynamic Range	$V_{IN.L}$	—	(Note 21)	Pin 30	5.0	5.4	—	V
	$V_{IN.R}$			Pin 26				
	$V_{IN.W}$			Pin 1				
Offset	ΔV_{BAS}	—	(Note 22)	Pin 21 Pin 22	—	110	350	mV
	ΔV_{TRB}							
	ΔV_{VOL}							
	ΔV_{WL}			Pin 8				
	ΔV_{BAL}			Pin 21 Pin 22				
Mute Residual Noise	MU.M	—	(Note 23)	Pin 21	—	—	100	μV_{p-p}
	MU.W			Pin 8				

CHARACTERISTICS	SYMBOL	TEST CIR-CUIT	TEST CONDITION	TEST PIN	MIN	TYP.	MAX	UNIT
LPF Off Mode	SW _L	2	(Note 24)	Pin 8	-2	0	2	dB
Port 1, Port 2 Low-Level Input Voltage	V _{1L}	2	(Note 25)	Pin 9	—	—	1.0	V
				Pin 10				
Port 1, Port 2 High-Level Input Voltage	V _{1H}	2	(Note 26)	Pin 9	3.5	—	V _{CC}	V
				Pin 10				
Port 6 Low-Level Output Voltage	V _{6Lo}	2	(Note 27)	Pin 15	—	—	0.5	V
Port 6 Medium-Level Output Voltage	V _{6Mid}	2	(Note 28)	Pin 15	2.0	2.5	3.0	V
Port 6 High-Level Output Voltage	V _{6Hi}	2	(Note 29)	Pin 15	4.5	5.0	—	V
Port 6 Source Current	I _{HiP6}	2	(Note 30)	Pin 15	—	—	2	mA
Port 6 Sink Current	I _{LoP6}	2	(Note 31)	Pin 15	—	—	300	μA
Port 3, Port 4, Port 5 Sink Current	I _{Lo}	2	(Note 32)	Pin 12 Pin 13 Pin 14	—	—	1	mA

TEST CONDITION

Note	CHARACTERISTIC		SW & VR MODE							INPUT SIGNAL	TEST METHOD	
			00H	01H	02H	03H	04H	05H	06H			07H
1	Gain	L-ch	32H	32H	64H	—	64H	32H	20H	10H	1kHz, 500mV	Measure gain between input and output.
		R-ch										
		W-ch									80Hz, 500mV	
2	Total Harmonic Distortion	L-ch	↑	↑	↑	↑	↑	↑	↑	↑	1kHz, 500mV	Measure distortion ratio.
		R-ch										
		W-ch									80Hz, 500mV	
3	S / N	L-ch	↑	↑	↑	↑	↑	↑	↑	↑	1kHz, 500mV	When level at sound signal is A and at no signal is B, determine $20 \log (A / B)$. Use 15kHz LPF.
		R-ch										
		W-ch									80Hz, 500mV	
4	Residual Noise	L-ch	↑	↑	↑	↑	00H	↑	↑	↑	Connect capacitor (0.01μF) between this pin and ground.	Noise level at minimum volume. Use 15kHz LPF.
		R-ch										
		W-ch										
5	Frequency Characteristic (100Hz)	L-ch	↑	↑	↑	↑	64H	↑	↑	↑	100Hz, 500mV	When 1kHz signal is input, output level is 0dB.
		R-ch										
6	Frequency Characteristic (10kHz)	L-ch	↑	↑	↑	↑	↑	↑	↑	↑	10kHz, 500mV	When 1kHz signal is
		R-ch										Difference from when $f_c = 100\text{Hz}$
7	LPF Frequency Characteristic (160Hz)	$f_c = 60\text{Hz}$	↑	↑	↑	↑	↑	↑	↑	00H	160Hz, 500mV	Difference from when $f_c = 120\text{Hz}$
		$f_c = 80\text{Hz}$								10H		Difference from when $f_c = 80\text{Hz}$
		$f_c = 100\text{Hz}$								20H		Difference from when LPF bypassed
		$f_c = 120\text{Hz}$								30H		
8	Balance Center		↑	↑	↑	↑	↑	↑	↑	10H	1kHz, 500mV	Measure gain difference between L and R.
9	Balance Minimum	L-ch	↑	↑	↑	↑	↑	64H	↑	↑	1kHz, 500mV	Measure residual noise at minimum balance. Use 1kHz BPF.
		R-ch						00H				
10	Treble Maximum	L-ch	↑	64H	↑	↑	↑	32H	↑	↑	10kHz, 500mV	When 1kHz signal is input with tone flat, output level is 0dB.
		R-ch										
11	Treble Minimum	L-ch	↑	00H	↑	↑	↑	↑	↑	↑	10kHz, 500mV	When 1kHz signal is input with tone flat, output level is 0dB.
		R-ch										

Note	CHARACTERISTICS		SW & VR MODE								INPUT SIGNAL	TEST METHOD
			00H	01H	02H	03H	04H	05H	06H	07H		
12	Bass Maximum	L-ch	64H	32H	64H	—	64H	32H	20H	10H	100Hz, 500mV	When 1kHz signal is input with tone flat, output level is 0dB.
		R-ch										
13	Bass Minimum	L-ch	00H	↑	↑	↑	↑	↑	↑	↑	100Hz, 500mV	When 1kHz signal is input with tone flat, output level is 0dB.
		R-ch										
14	Volume Center	L-ch	32H	↑	32H	↑	↑	↑	↑		1kHz, 500mV	At maximum volume, output level is 0dB.
		R-ch										
		W-ch									80Hz, 500mV	
15	Level Center	W-ch	↑	↑	64H	↑	32H	↑	↑	↑	80kHz, 500mV	At maximum level, output level is 0dB.
16	Residual Noise	L-ch	↑	↑	00H	↑	00H	↑	↑	↑	1kHz, 500mV	Measure output amplitude at minimum volume.
		R-ch										
		W-ch									80Hz, 500mV	
17	Cross Talk	L→R	↑	↑	64H	↑	64H	↑	↑	↑	1kHz, 500mV	R output at L input.
		R→L										L output at R input
		L→W									80Hz, 500mV	W output at L input
		R→W								W output at R input.		
		W→L										L output at W input
		W→R										R output at W input.
18	Ripple Rejection Ratio (Minimum Volume)	L-ch	↑	↑	00H	↑	↑	↑	↑		60Hz, 500mV	Add V _{CC} via 51Ω and input signal from pin 24.
		R-ch										
19	Ripple Rejection Ratio (Maximum Volume)	L-ch	↑	↑	64H	↑	↑	↑	↑	↑	60Hz, 500mV	Add V _{CC} via 51Ω and input signal from pin 24.
		R-ch								↑		
		W-ch										
20	Output Dynamic Range	L-ch	64H	64H	↑	↑	↑	↑	↑	↑	100Hz, 10kHz	Output amplitude when output distorts (THD = 1%).
		R-ch									80Hz	
		W-ch										
21	Input Dynamic Range	L-ch	32H	32H	32H	↑	↑	↑	↑	↑	1kHz	Input amplitude when output distorts (THD = 1%).
		R-ch									80Hz	
		W-ch										

Note	CHARACTERISTICS		SW & VR MODE								INPUT SIGNAL	TEST METHOD	
			00H	01H	02H	03H	04H	05H	06H	07H			
22	Offset	BAS	(*)	(*)	(*)	—	—	(*)	(*)	20H	10H	Connect capacitor (0.01μF) between this pin and ground.	DC fluctuation due to bus control
		TRB											
		VOL											
		W LEV											
		BAL											
23	Mute Residual Noise	L-ch	32H	32H	64H	↑	64H	32H	20H	11H	1kHz, 500mV	—	
		W-ch								12H	80Hz, 500mV		
24	LPF Off Mode	W-ch	↑	↑	↑	↑	↑	↑	↑	14H	1kHz, 500mV	—	
25	Port1, Port2 Low-Level Input Voltage	—	—	—	—	—	—	—	—	—	—	—	—
26	Port 1, Port 2 High-Level Input Voltage	—	—	—	—	—	—	—	—	—	—	—	—
27	Port 6 Low-Level Output Voltage	—	—	—	—	—	—	—	20H	—	—	—	—
28	Port 6 Medium-Level Output Voltage	—	—	—	—	—	—	—	10H	—	—	—	—
29	Port 6 High-Level Output Voltage	—	—	—	—	—	—	—	30H	—	—	—	—
30	Port 6 Source Current	—	—	—	—	—	—	—	20H	—	—	—	—
31	Port 6 Sink Current	—	—	—	—	—	—	—	↑	—	—	—	—
32	Port 3, Port 4, Port 5 Sink Current	—	—	—	—	—	—	—	1FH	—	—	—	—

TEST CIRCUIT

DC characteristic

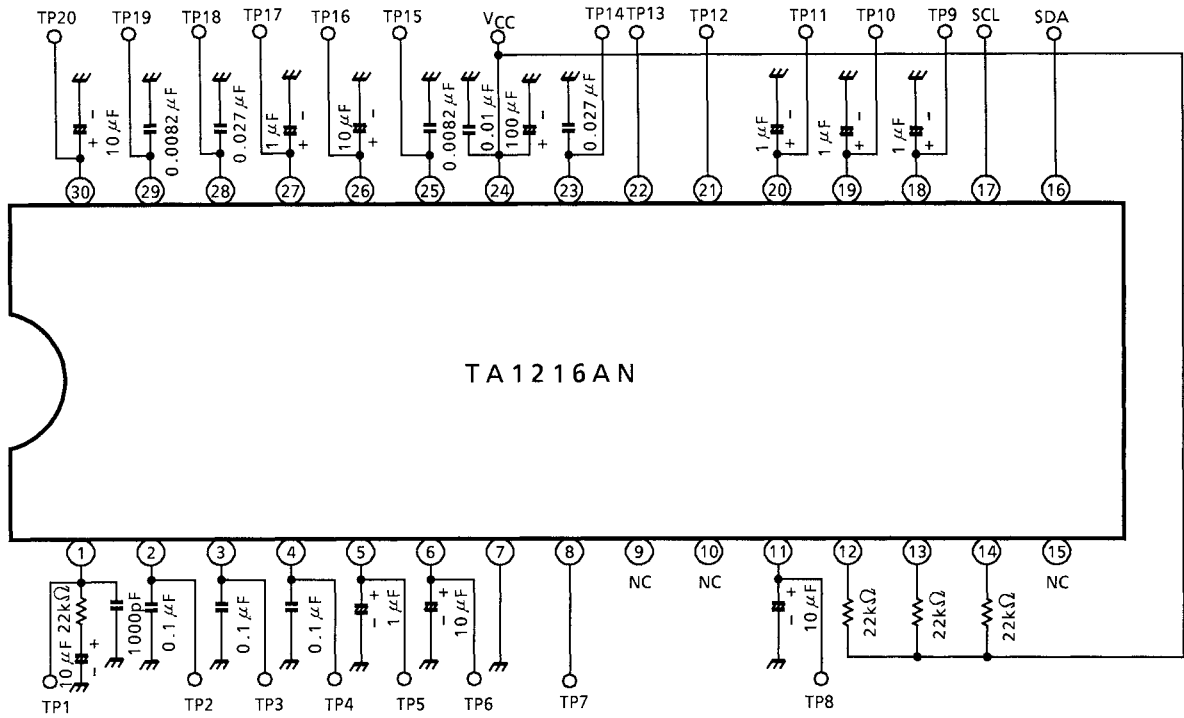

AC characteristic

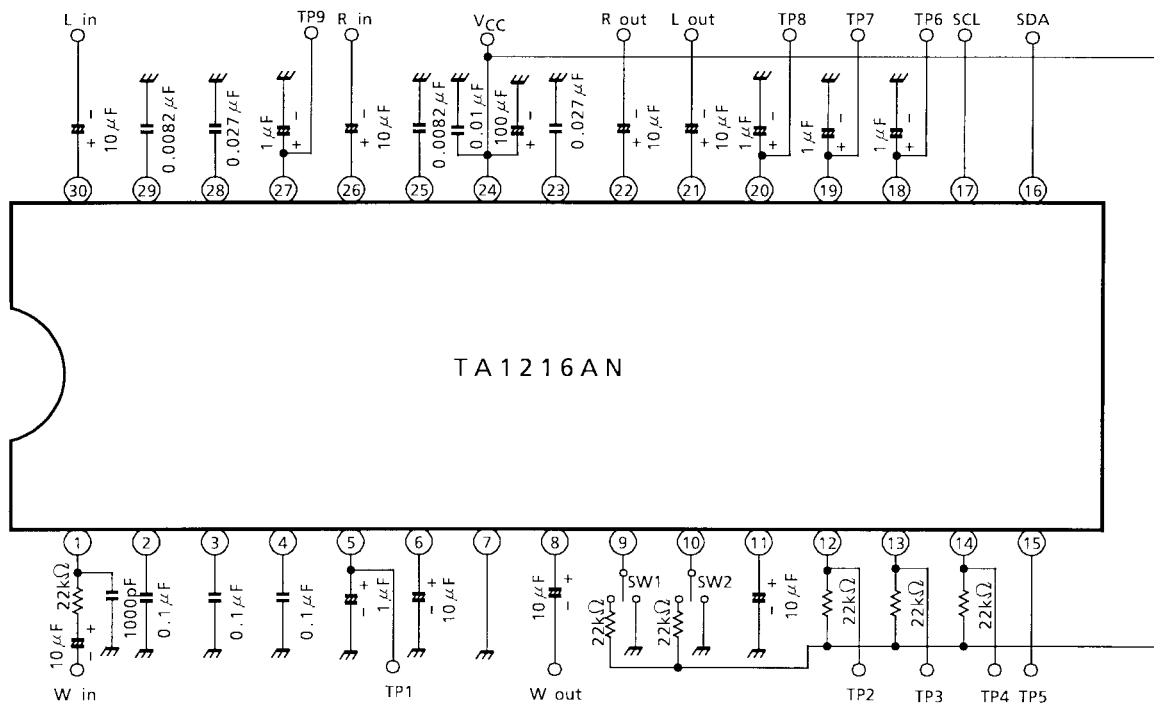

APPLICATION CIRCUIT

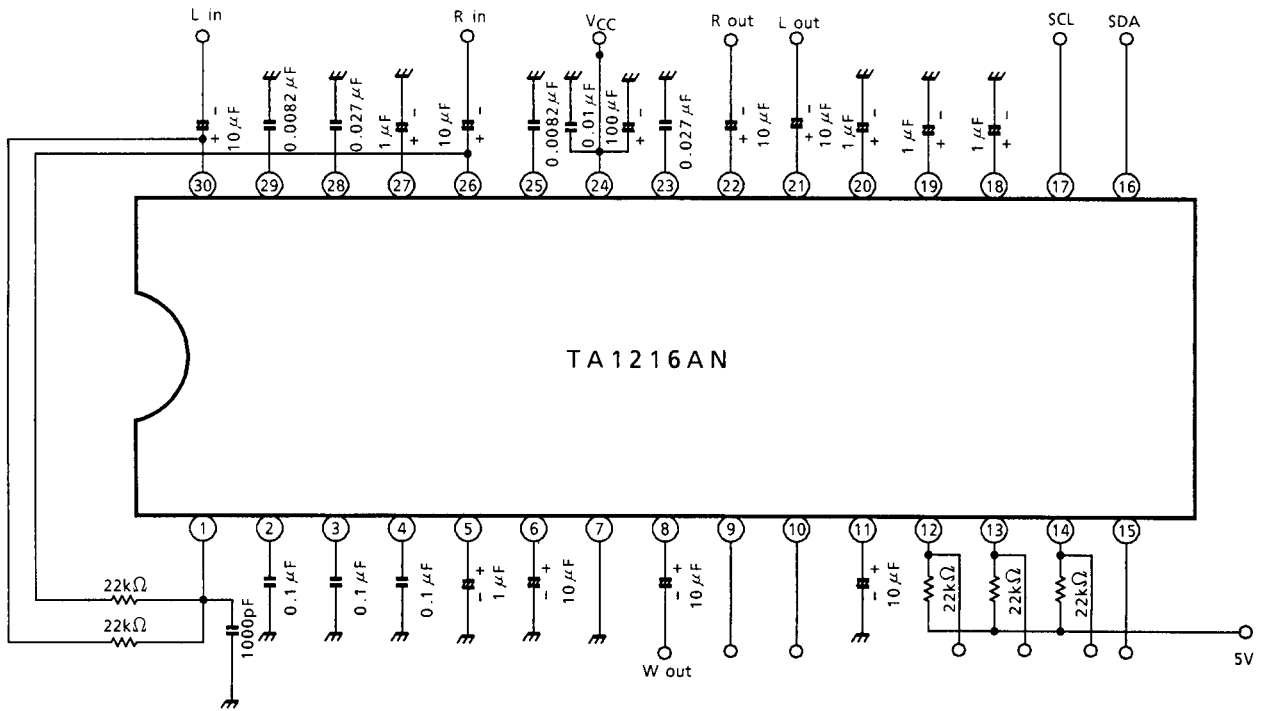

PACKAGE DIMENSIONS

SDIP30-P-400-1.78

Unit : mm

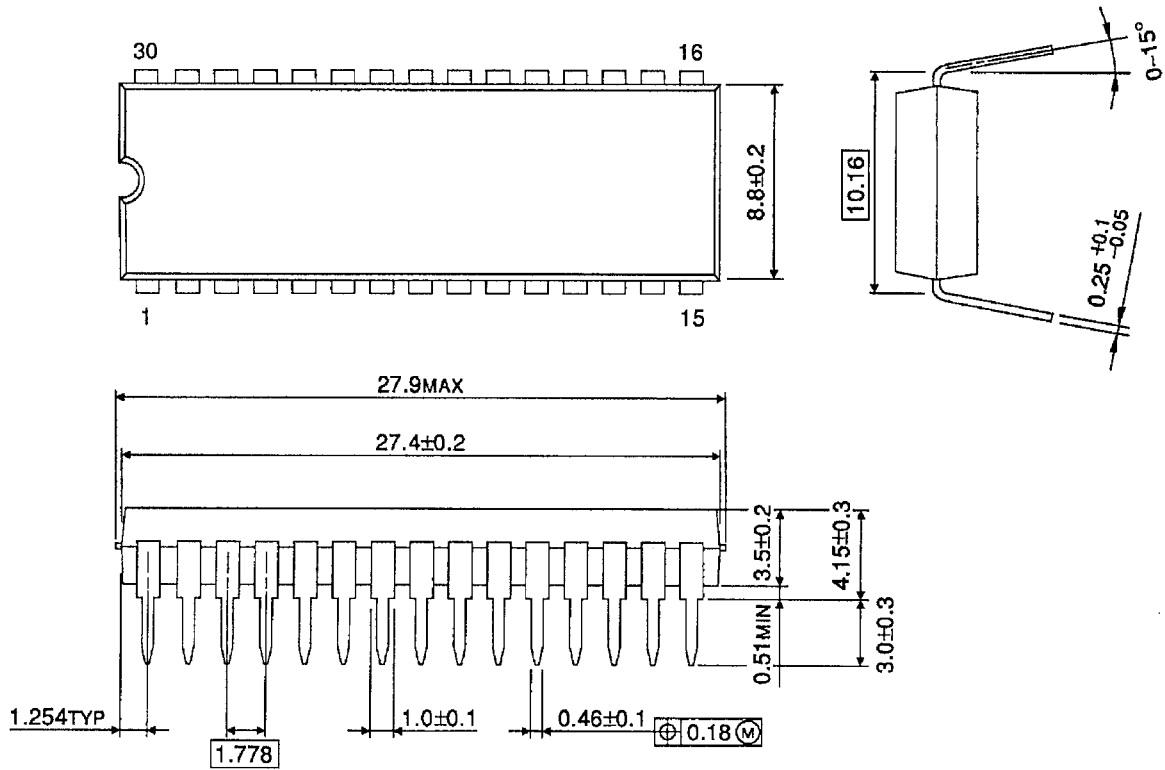

Weight: 1.99 g (Typ.)