

TOSHIBA Bipolar Linear Integrated Circuit Silicon Monolithic

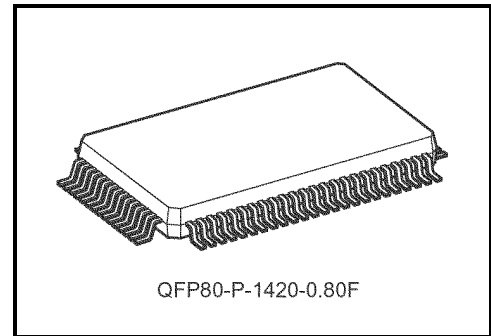
# TA1360AFG

YCbCr/YPbPr Signal and Sync Processor for Digital TV, Progressive Scan TV and Double Scan TV

The TA1360AFG integrates an analog component signal (YCbCr/YPbPr) processor and sync processor in a 80-pin QFP plastic package. The IC is ideal for digital TVs, progressive TVs, and double scan TVs.

The luminance block and the color difference block incorporate the high performance signal processing circuits. The sync processor block supports 525I/60, 625I/50, 525P/60, 625P/50, 1125I/50, 1125I/60, 750P/60, (750P/50), PAL100 Hz, NTSC120 Hz, and SVGA/60(VESA).

The TA1360AFG incorporates the I<sup>2</sup>C bus. The device can control various functions via the bus line.



Weight: 1.6 g (typ.)

## Features

### Luminance Block

- Black stretch circuit and DC restoration rate correction circuit
- Dynamic  $\gamma$  correction circuit (gray scale correction)
- SRT (LTI)
- Y group delay correction (shoot balance correction)
- High-bright color circuit
- Color detail enhancer (CDE)
- White pulse limiter (WPL)
- VSM output

### Color difference Block

- Fresh color correction
- Dynamic Y/C correction circuit
- Color SRT (CTI)
- Color  $\gamma$  circuit
- Green stretch
- Blue stretch

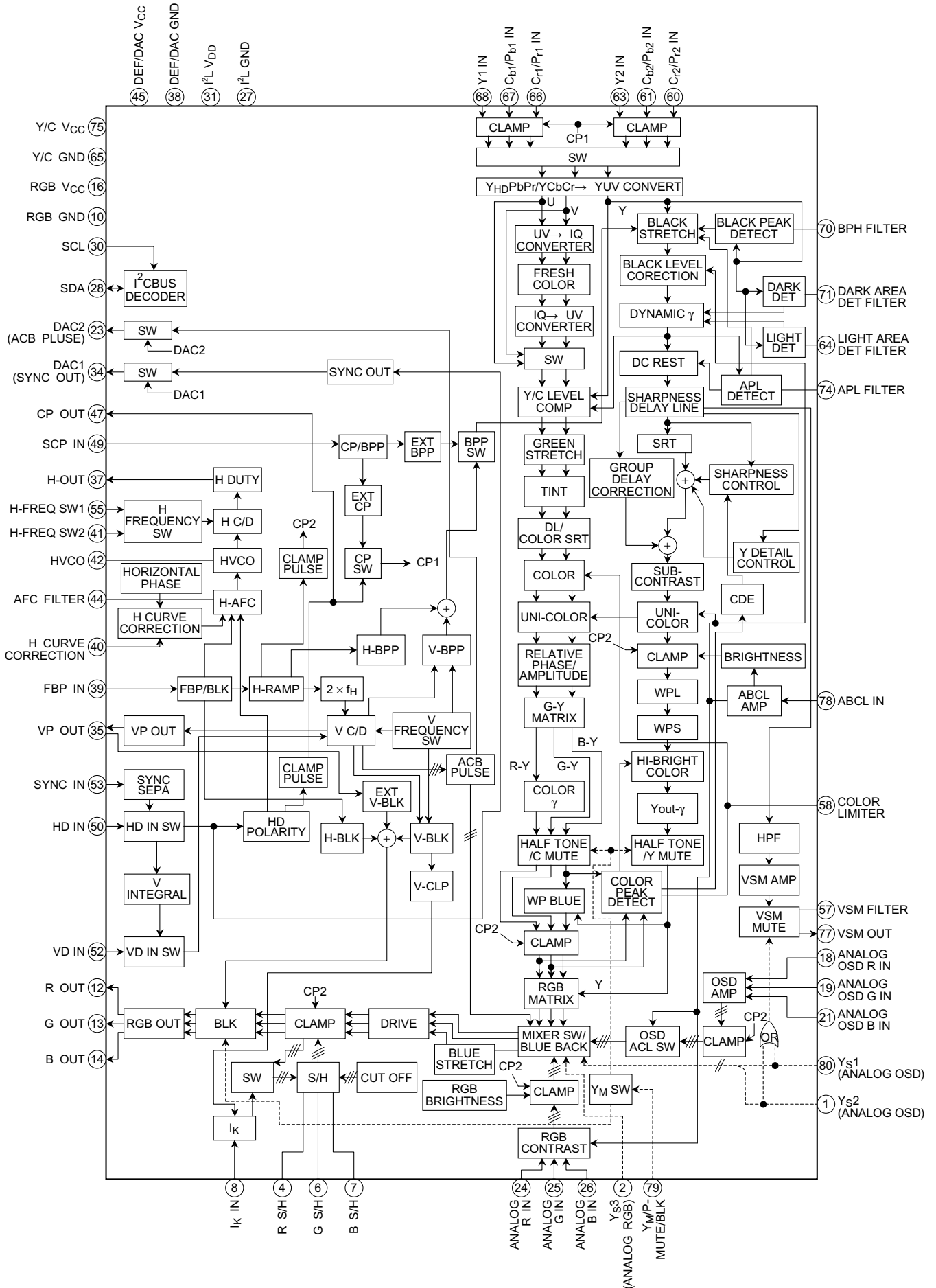
### Text Block

- OSD blending SW
- ACB (only black level)
- Two analog RGB inputs

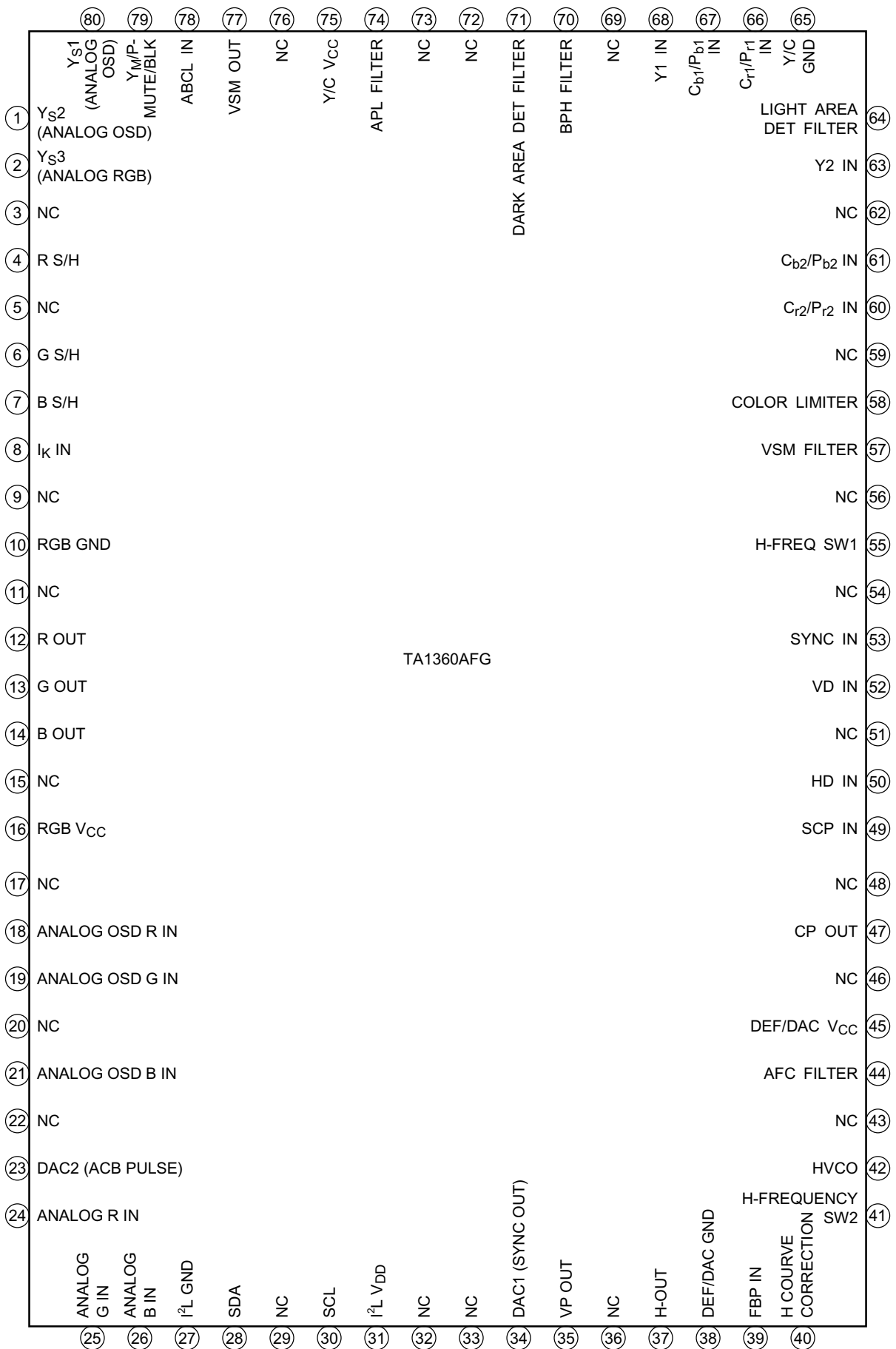
### Synchronization Block

- Horizontal sync (15.75 k, 28.125 k, 31.5 k, 33.75 k, 37.9 k, 45 kHz)
- Vertical sync (525I/P, 625I/P, 750P, 1125I/P, PAL 100 Hz/NTSC 120 Hz)
- 2- and 3-level sync separator circuit
- HD/VD input (positive and negative polarities)
- Copy guard
- Vertical blanking

Block Diagram



## Pin Assignment

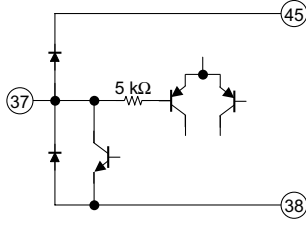
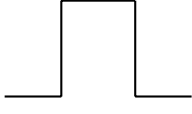
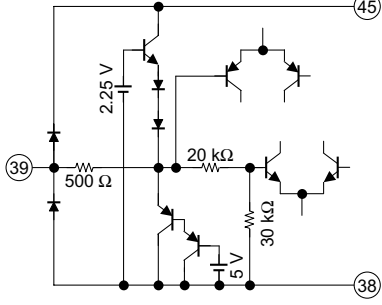
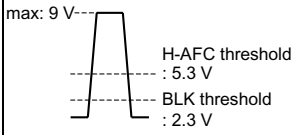
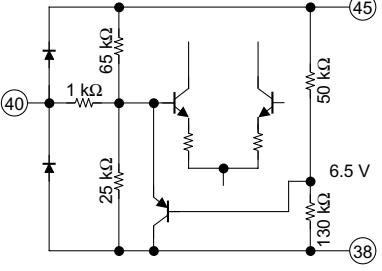
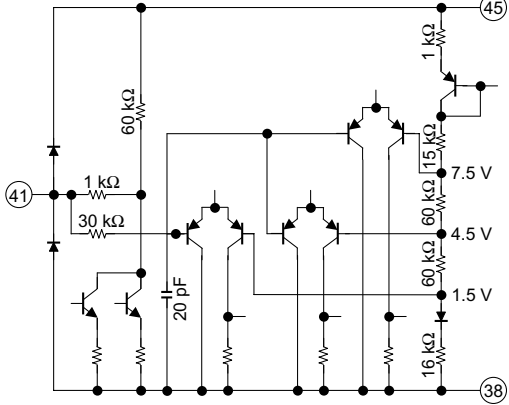
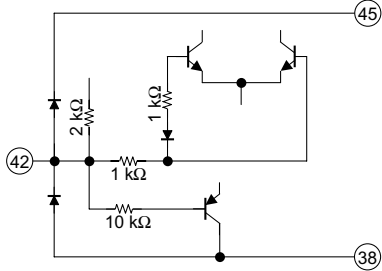


Pin Functions

Pin No.	Pin Name	Function	Interface Circuit	Input Signal/Output Signal															
1 80	Y <sub>S</sub> 2 (analog OSD)  Y <sub>S</sub> 1 (analog OSD)	<p>Switches internal RGB and OSD input signals.</p> <p>The blend ratio of internal RGB and OSD signals can be adjusted according to applying voltage to pins Y<sub>S</sub>1 and Y<sub>S</sub>2.</p> <p>VSM output is muted when Y<sub>S</sub>1 or Y<sub>S</sub>2 pin is set to High.</p> <table border="1"> <thead> <tr> <th>Y<sub>S</sub>2</th> <th>Y<sub>S</sub>1</th> <th>Blend ratio Int RGB: OSD RGB</th> </tr> </thead> <tbody> <tr> <td>L</td> <td>L</td> <td>10:0</td> </tr> <tr> <td>H</td> <td>L</td> <td>7:3</td> </tr> <tr> <td>L</td> <td>H</td> <td>5:5</td> </tr> <tr> <td>H</td> <td>H</td> <td>0:10</td> </tr> </tbody> </table>	Y <sub>S</sub> 2	Y <sub>S</sub> 1	Blend ratio Int RGB: OSD RGB	L	L	10:0	H	L	7:3	L	H	5:5	H	H	0:10		<p>0 to 0.5 V : Internal</p> <p>1.1 V to 1.7 V : VSM Mute</p> <p>2.9 V to 9 V : OSD, VSM Mute</p>
Y <sub>S</sub> 2	Y <sub>S</sub> 1	Blend ratio Int RGB: OSD RGB																	
L	L	10:0																	
H	L	7:3																	
L	H	5:5																	
H	H	0:10																	
2	Y <sub>S</sub> 3 (analog RGB)	<p>Switches internal RGB and external analog RGB input.</p> <p>VSM output is muted when analog RGB is selected.</p>		<p>0 to 0.5 V : Internal</p> <p>1.5 V to 9 V : Analog RGB, VSM Mute</p>															
3	NC	<p>This pin is not used.</p> <p>Connect to GND.</p>	—	—															
4 6 7	R S/H  G S/H  B S/H	<p>S/H (sample-and-hold) pin.</p> <p>In ACB Mode, connect 2.2-μF capacitor. In CUT-OFF Mode, connect 0.01-μF capacitor.</p>		DC															
5	NC	<p>This pin is not used.</p> <p>Connect to GND.</p>	—	—															
8	I <sub>K</sub> IN	<p>Inputs feedback signal from CRT. (BLK level should be 0 to 3 V.)</p> <p>When ACB function is not used, connect this pin to RGB V<sub>CC</sub> pin.</p>		<p>1 V<sub>p-p</sub> (typ.) R G B</p> <p>0~3 V</p> <p>or RGB V<sub>CC</sub></p>															
9	NC	<p>This pin is not used.</p> <p>Connect to GND.</p>	—	—															
10	RGB GND	GND pin for text/RGB block	—	—															
11	NC	<p>This pin is not used.</p> <p>Connect to GND.</p>	—	—															

Pin No.	Pin Name	Function	Interface Circuit	Input Signal/Output Signal
12 13 14	R OUT G OUT B OUT	Outputs R/G/B signal. Recommended output amplitude: 100 IRE = 2.3 Vp-p		100 IRE: 2.3 Vp-p Conditions: UNI-COLOR = max SUB-CONT = Cent Y IN = 0.7 Vp-p
15	NC	This pin is not used. Connect to GND.	—	—
16	RGB VCC	VCC pin for text/RGB block. See "Maximum Ratings" about the supply voltage.	—	—
17	NC	This pin is not used. Connect to GND.	—	—
18 19 21	ANALOG OSD R IN ANALOG OSD G IN ANALOG OSD B IN	Inputs analog OSD signal via clamp capacitor.		100 IRE: 0.7 Vp-p (not including sync)
20 22	NC	This pin is not used. Connect to GND.	—	—
23	DAC2 (ACB pulse)	Outputs 1-bit DAC or pulse over ACB period. Open-collector output.		DC or ACB PULSE 
24 25 26	ANALOG R IN ANALOG G IN ANALOG B IN	Inputs analog R/G/B signal via clamp capacitor.		100 IRE: 0.7 Vp-p (not including sync)
27	I <sup>2</sup> L GND	GND pin for I <sup>2</sup> L block	—	—

Pin No.	Pin Name	Function	Interface Circuit	Input Signal/Output Signal
28	SDA	SDA pin for I <sup>2</sup> C BUS		—
29	NC	This pin is not used. Connect to GND.	—	—
30	SCL	SCL pin for I <sup>2</sup> C BUS		—
31	I <sup>2</sup> L V <sub>DD</sub>	V <sub>DD</sub> pin for I <sup>2</sup> L block. Connects 2 V (typ.). Supply power via zener diode through resistor from pin 45. (See "Application Circuit")	—	—
32	NC	This pin is not used.	—	—
33	NC	Connect to GND.	—	—
34	DAC1 (SYNC OUT)	Outputs 1-bit DAC or separated SYNC. Open-collector output.		DC or SYNC OUT 
35	VP OUT	Outputs vertical pulse. Applying current to this pin, performs external blanking by OR-ing with internal blanking. Note: Changing H-position varies VP output width. Use the start phase only for VP output.		VP output:  Start phase V-BLK input current: 780 μA to 1 mA
36	NC	This pin is not used. Connect to GND.	—	—

Pin No.	Pin Name	Function	Interface Circuit	Input Signal/Output Signal
37	H-OUT	Horizontal output pin. Open-collector output.		
38	DEF/DAC GND	GND pin for DEF/DAC block	—	—
39	FBP IN	Inputs FBP for horizontal AFC. Sets H-BLK width.		
40	H CURVE CORRECTION	Adjusts screen curve at high voltage fluctuation. Input AC component of high voltage fluctuation. When not used, connect 0.01-μF capacitor between this pin and GND.		DC
41	H-FREQ SW2	Switches horizontal frequency (Switch 2). Leave this pin open when horizontal frequency is switched by Bus controlling. Controlling this pin prevails over Bus control. (Refer to Table 1: Bus control function.) When this IC is used for CRT, frequency of horizontal output (pin 37) is controlled according to voltage of this pin. DC voltage that is generated by dividing resistor of DEF V <sub>CC</sub> (pin 45) should be used to control this pin.		<p>At BUS control (horizontal frequency) : output voltage value</p> <ul style="list-style-type: none"> <li>28 k/15 kHz : DC 9 V</li> <li>31 kHz : DC 6 V</li> <li>33 kHz : DC 3 V</li> <li>37 k/45 kHz : DC 0 V</li> </ul> <p>At pin 22 control, horizontal frequency and input voltage value</p> <ul style="list-style-type: none"> <li>0 to 1.0 V : 37 k/45 kHz</li> <li>2.0 V to 4.0 V : 33 kHz</li> <li>5.0 V to 7.0 V : 31 kHz</li> <li>8.0 V to 9.0 V : 28 k/15 kHz</li> </ul>
42	HVCO	Connects ceramic oscillator for horizontal oscillation. Use Murata "CSBLA503KECF30".		—
43	NC	This pin is not used. Connect to GND.	—	—

Pin No.	Pin Name	Function	Interface Circuit	Input Signal/Output Signal
44	AFC FILTER	Connects filter for detecting AFC.		DC
45	DEF/DAC V <sub>CC</sub>	V <sub>CC</sub> pin for DEF/DAC block. See "Maximum Ratings" about the supply voltage.	—	—
46	NC	This pin is not used. Connect to GND.	—	—
47	CP OUT	Outputs internal clamp pulse (CP).		
48	NC	This pin is not used. Connect to GND.	—	—
49	SCP IN	Inputs SCP from up converter. Input signals are clamp pulse (CP) and black peak detection stop pulse (BPP).		2.2 V to 2.8 V : BPP 4.2 V to 9 V : CP
50	HD IN	Inputs horizontal sync HD signal. Inputs positive- or negative-polarity signals.		
51	NC	This pin is not used. Connect to GND.	—	—
52	VD IN	Inputs vertical sync VD signal. Inputs positive- or negative-polarity signals.		



Pin No.	Pin Name	Function	Interface Circuit	Input Signal/Output Signal
53	SYNC IN	Inputs Y signal with sync signal via clamp capacitor.		White 100%: 1 V <sub>p-p</sub> or 
54	NC	This pin is not used. Connect to GND.	—	—
55	H-FREQ SW1	Switches horizontal frequency (Switch 1). Leave this pin open when horizontal frequency is switched by Bus controlling. Controlling this pin prevails over Bus control. (Refer to Table 1: Bus control function.) When this IC is used for CRT, connect this pin to DEF V <sub>CC</sub> (pin 45) or DEF GND (pin 38). If it is not necessary to control this pin on CRT, connect this pin directly to DEF V <sub>CC</sub> or DEF GND on the PCB.		DEF V <sub>CC</sub> or DEF GND
56	NC	This pin is not used. Connect to GND.	—	—
57	VSM FILTER	Connects VSM output filter. Please connect 0.01-μF capacitor between this pin and GND.		DC
58	COLOR LIMITER	Connects filter for detecting color limit.		DC
59	NC	This pin is not used. Connect to GND.	—	—

Pin No.	Pin Name	Function	Interface Circuit	Input Signal/Output Signal
60	$C_{r2}/P_{r2}$ IN	Inputs $C_{r2}/P_{r2}$ signal via clamp capacitor.		700 mVp-p/700 mVp-p at 100% color bar for $C_{r1}/P_{r1}$
61	$C_{b2}/P_{b2}$ IN	Inputs $C_{b2}/P_{b2}$ signal via clamp capacitor.		700 mVp-p at 100% color bar for $C_{b1}/P_{b1}$
63	Y2 IN	Inputs Y2 signal via clamp capacitor.		1 Vp-p (including sync) at 100% color bar or 
62	NC	This pin is not used. Connect to GND.	—	—
64	LIGHT AREA DET FILTER	Connects filter for detecting light area. Voltage of this pin controls dynamic $\gamma$ circuit gain for light area.		DC
65	Y/C GND	GND pin for Y/C block	—	—
66	$C_{r1}/P_{r1}$ IN	Inputs $C_{r1}/P_{r1}$ signal via clamp capacitor.		700 mVp-p/700 mVp-p at 100% color bar for $C_{r1}/P_{r1}$
67	$C_{b1}/P_{b1}$ IN	Inputs $C_{b1}/P_{b1}$ signal via clamp capacitor.		700 mVp-p at 100% color bar for $C_{b1}/P_{b1}$
68	Y1 IN	Inputs Y1 signal via clamp capacitor.		1 Vp-p (including sync) at 100% color bar or 
69	NC	This pin is not used. Connect to GND.	—	—

Pin No.	Pin Name	Function	Interface Circuit	Input Signal/Output Signal
70	BPH FILTER	<p>Connects filter for detecting black peak.</p> <p>Voltage of this pin controls black stretch gain.</p> <p>Leaving Y open and setting the test circuit SW 2 = C enable to monitor H/V-BPP (black-stretch-stop pulse) width.</p>		DC
71	DARK AREA DET FILTER	<p>Connects filter for detecting dark area.</p> <p>Voltage of this pin controls dynamic <math>\gamma</math> circuit gain for dark area.</p>		DC
72 73	NC	<p>This pin is not used.</p> <p>Connect to GND.</p>	—	—
74	APL FILTER	<p>Connects filter for correcting DC restoration rate.</p> <p>Leaving this pin open enables to monitor Y signal after black stretch and dynamic <math>\gamma</math>.</p>		—
75	Y/C VCC	<p>VCC pin for Y/C block.</p> <p>See "Maximum Ratings" about the supply voltage.</p>	—	—
76	NC	<p>This pin is not used.</p> <p>Connect to GND.</p>	—	—
77	VSM OUT	<p>Outputs Y signal for VSM that passed through HPF circuit (first differential circuit).</p> <p>Output signals are muted according to pins 1, 2, and 80.</p>	See pin 57.	—
78	ABCL IN	<p>Inputs ABL and ACL signals.</p> <p>Sets gain and start point of ABL and dynamic ABL signal according to bus controlling.</p>		DC

Pin No.	Pin Name	Function	Interface Circuit	Input Signal/Output Signal
79	Y <sub>M</sub> /P-MUTE/BLK	High-speed halftone switch for internal RGB signal. Enables picture mute and blanking.		0 to 0.5 V : Internal 1.2 V to 1.8 V : Half Tone 2.7 V to 4.0 V : P-Mute 7 V to 9 V : Blanking

## Bus Control Map

### Write Data

Slave Address: 88H

Sub-Add	D7	D6	D5	D4	D3	D2	D1	D0	Preset
00	H-FREQ1		H-DUTY	YUV-SW	DAC1	DAC2	SYNC-SW	H-FREQ2	1000 : 0000
01	HORIZONTAL POSITION							CLP-PHS	1000 : 0000
02	ACB-MODE		SCP-SW	HBP-PHS1	SYNC SEP-LEVEL		TEST		1000 : 0000
03	V-BLK PHASE				VERTICAL FREQUENCY				1000 : 0000
04	COMPRESSION-BLK PHASE-1				COMPRESSION-BLK PHASE-2				1000 : 0000
05	P-MODE1	UNI-COLOR							1000 : 0000
06	BRIGHTNESS								1000 : 0000
07	OSD-ACL	COLOR							1000 : 0000
08	TINT							HBP-PHS2	1000 : 0000
09	PICTURE SHARPNESS							BLS $\gamma$	1000 : 0000
0A	RGB BRIGHTNESS							DCRR-SW	1000 : 0000
0B	HI BRT	RGB CONTRAST							1000 : 0000
0C	SUB CONTRAST				WPS	YUV MODE	Y-OUT $\gamma$		1000 : 0000
0D	DRIVE GAIN1							DR-R	1000 : 0000
0E	DRIVE GAIN2							DR-B/G	1000 : 0000
0F	R CUT OFF								1000 : 0000
10	G CUT OFF								1000 : 0000
11	B CUT OFF								1000 : 0000
12	R-Y/B-Y GAIN				R-Y/B-Y PHASE				1000 : 0000
13	G-Y/B-Y GAIN				G-Y/B-Y PHASE				1000 : 0000
14	COLOR SRT TRAN	C FREQ	GREEN STRETCH		COLOR $\gamma$		CLT		1000 : 0000
15	C.D.E.	Y/C GAIN COMP		BL STRETCH GAIN		FLESH	H-SHIFT		1000 : 0000
16	VSM PHASE			VSM GAIN			APACON PEAK FREQ		1000 : 0000
17	DC REST POINT			DC REST RATE			DC REST LIMIT		1000 : 0000
18	BLACK STRETCH POINT			APL VS BSP		B.L.C.	B.D.L	BS-AREA	1000 : 0000
19	SRT-GAIN				WPL-LEVEL				1000 : 0000
1A	D-ABL POINT		D-ABL GAIN		BL STRETCH POINT		P-MODE2		1000 : 0000
1B	ABL POINT			ABL GAIN			RGB OUT MODE		1000 : 0000
1C	DYNC $\gamma$ GAIN		BS-CHAR1	STATIC $\gamma$ GAIN-1			STATIC $\gamma$ GAIN-2		1000 : 0000
1D	OSD BRIGHT		OSD CONTRAST		Y/C-DL1	DYNC $\gamma$ AREA			1000 : 0000
1E	Y DETAIL CONTROL				BS-CHAR2	WP BLUE POINT			1000 : 0000
1F	Y GROUP DELAY CORRECTION				Y/C-DL2	WP BLUE GAIN			1000 : 0000

### Read Data

Slave Address: 89H

	D7	D6	D5	D4	D3	D2	D1	D0
0	POR	IK-IN	RGB-OUT	YUV-IN	H-OUT	VP-OUT	RGB-IN	SYNC-IN

## Bus Control Features

### Write Mode

Resister Name	Description	Preset Value
H-FREQ1/2	Switches horizontal oscillation frequency. (See the appendix 1)	33.75 kHz
H-DUTY	Switches horizontal output duty. 0: 41% 1: 47%	41%
YUV-SW	Switches YUV input. 0: INPUT-1 (Y1/C <sub>b1</sub> /C <sub>r1</sub> ) 1: INPUT-2 (Y2/C <sub>b2</sub> /C <sub>r2</sub> )	INPUT-1
DAC 1	Switches DAC controlling output. 0: OPEN (high) 1: ON (low) Controls 1-bit DAC of open-collector when TEST is 00. Outputs H/C-SYNC from pin 34 when TEST is 01.	OPEN
DAC 2	Switches DAC controlling output. 0: ON (low), 1: OPEN (high) Controls 1-bit DAC of open-collector when TEST is 00. Outputs ACB reference pulse from pin 23 when TEST is 01.	ON
SYNC-SW	Switches sync input. 0: Selects HD/VD input. 1: Selects SYNC input.	HD/VD
HORIZONTAL POSITION	Adjusts horizontal picture position (phase). 0000000: -12.5% 1111111: +12.5% Note: VP output width (pin 35) varies with a change of horizontal position.	CENTER
CLP-PHS	Switches clamp pulse phase. 0: 0.7- $\mu$ s (2.5%) width, 1.1- $\mu$ s (3.8%) delay from HD stop phase. 1: 0.7- $\mu$ s (2.4%) width, 0.2- $\mu$ s (0.7%) delay from HD stop phase when no signal, 0.8- $\mu$ s (2.7%) width that is 1.2- $\mu$ s (4.2%) delay from FBP start phase. Also switches CP phase of CP-OUT (pin 47).	1.1- $\mu$ s delay
ACB MODE	Sets ACB mode; Sets converged reference level. 00: ACB OFF (cutoff BUS control), 01: ACB ON (5 IRE), 10: ACB ON (10 IRE) 11: ACB ON (20 IRE)	ACB ON (10 IRE)
SCP-SW	SCP (sand castle pulse) Switches modes. 0: Internal Mode 1: External input Mode	Internal Mode
HBP-PHS1/2	Switches phase of black-stretch-detection stop pulse. HBP-PHS1 = 0 and HBP-PHS2 = 0: FBP $\pm$ 3% HBP-PHS1 = 0 and HBP-PHS2 = 1: FBP $\pm$ 8% HBP-PHS1 = 1 and HBP-PHS2 = 0: FBP $\pm$ 13% HBP-PHS1 = 1 and HBP-PHS2 = 1: FBP $\pm$ 18% Leaving Y open and setting the test circuit SW2 to C enable to monitor H/V-BPP (black-stretch-detection stop pulse) width through pin 70.	$\pm$ 3%
SYNC SEP-LEVEL	Switches Sync SEP-level. 00: 16% 01: 24% 10: 32% 11: 40% (At 1125I/60)	16%
TEST	Test Mode: Controls 1-bit DAC of open-collector when TEST is 00. Outputs H/C-SYNC from pin 34, and ACB reference pulse from pin 23 when TEST is 01. Do not set TEST to 10/11 for that is shipment TEST Mode.	00

Resister Name	Description	Preset Value
V-BLK PHASE	Switches vertical BLK stop phase. 00000: 16 H~ 11110: 46 H (1 H/STEP) 11111: Internal H/V-BLK OFF Please set ACB Mode to OFF when internal H/V-BLK is OFF (11111).	32 H
V-FREQUENCY	Vertical free-run frequency: Sets V pull-in range. (See Appendix 2.)	1281 H
COMPRESSION-BLK PHASE-1/2	Compression BLK phase: Sets BLK for upper and lower parts of screen. (See Appendix 3.)	CENTER, OFF
P-MODE1/2	Picture Mode: Sets picture mute, halftone, blue background, and Y mute. (See Appendix 4.)	P-MUTE 1
UNI-COLOR	Unicolor adjustment: 0000000: -16dB~ 1111111: 0dB	min
BRIGHTNESS	Brightness adjustment: 00000000: -40 IRE 11111111: +40 IRE	CENTER
OSD-ACL	OSD-ACL; 0: OFF 1: ON	ON
COLOR	Color adjustment: 0000000: COLOR MUTE, 0000001: -20dB or more 1111111: +4dB	C-MUTE
TINT	Tint adjustment: 0000000: -32 deg~ 1111111: +32 deg	±0 deg
PICTURE-SHARPNESS	Sharpness adjustment: 0000000: -10dB or more 1000000: +10dB 1111111: +17.5dB (at peak FREQ)	CENTER
BLS <sub>γ</sub>	Blue stretch $\gamma$ correction: B-axis correction 0: OFF 1: ON	OFF
RGB-BRIGHTNESS	RGB brightness: 0000000; -20 IRE~ 1111111; +20 IRE	CENTER
DCRR-SW	Switches DC restoration rate. 0: 100% or higher 1: 100% or lower	100% or higher
HI BRT	High-bright color: 0: OFF 1: ON	ON
RGB-CONTRAST	RGB contrast: 0000000: -16.5dB 1111111: 0dB	min
SUB-CONTRAST	Sub-contrast: 00000: -3.3dB 11111: +2.5dB	CENTER
WPS	WPS level: 0: 110 IRE 1: 130 IRE	110 IRE
YUV MODE	Y/color-difference input Mode: 0: Y/Cb/Cr, 1: Y/Pb/Pr (Remarks) Y/Cb/Cr: ITU-R BT 601 Y/Pb/Pr: ITU-R BT 709 (1125/60/2:1)	Y/Cb/Cr
Y-out <sub>γ</sub>	Y-out gamma control: 0: OFF 1: ON	OFF
DRIVE GAIN1/2	Drive gain 1/2; 0000000: -5dB 1111111: +3dB	CENTER
DR-R DR-B/G	Switches RGB drive gain base. (See Appendix 5.)	R

Resister Name	Description	Preset Value
R/G/B CUT OFF	R/G/B cutoff: 1) At ACB-OFF RGB-OUT 00000000: 1.9 V 11111111: 2.9 V 2) At ACB-ON SENS-IN 00000000: 0.5 Vp-p 11111111: 1.5 Vp-p	CENTER
R-Y/B-Y GAIN	Switches R-Y/B-Y relative amplitude: 0000: min (0.45) 1111: max (0.9)	CENTER
R-Y/B-Y PHASE	Switches R-Y/B-Y relative phase: 0000: min (90 deg) 1111: max (111.5 deg)	min
G-Y/B-Y GAIN	Switches G-Y/B-Y relative amplitude: 0000: min (0.25) 1111: max (0.48)	CENTER
G-Y/B-Y PHASE	Switches G-Y/B-Y relative phase: 0000: min (232 deg) 1111: max (254 deg)	min
COLOR SRT TRAN	Color SRT transient: Color-difference transient improvement 00: C-SRT OFF~ 11: max	CENTER
C FREQ	Color SRT peak frequency: 0: 4.5 MHz 1: 5.8 MHz	4.5 MHz
GREEN STRETCH	Green stretch: 00: OFF~ 11: max (+3dB)	OFF
COLOR $\gamma$	Color $\gamma$ correction point 00: OFF, 01: 0.23 Vp-p, 10: 0.40 Vp-p, 11: 0.58 Vp-p	OFF
CLT	Color limiter level: 0: 1.65 Vp-p, 1: 2 Vp-p	1.65 Vp-p
CDE	Color detail enhancer: 00: min 11: max	CENTER
Y/C GAIN COMP	Dynamic Y/C compensation: Operated when luminance level is made up according to dynamic $Y\gamma$ . 00: OFF~ 11: max	OFF
BL STRETCH GAIN	Blue stretch gain: B-axis correction 00: OFF 11: max (+6.4dB)	OFF
FLESH	Flesh color: Skin tone color correction 0: OFF 1: ON (Lead-in angle: $\pm 33.7$ deg)	OFF
H-SHIFT	Shifts a center of horizontal picture position (phase): 0: OFF 1: ON (FBP shifts 6.7% against HD)	OFF
VSM-PHASE	VSM phase: 000: -37.5 ns 101: normal 111: +15 ns	CENTER
VSM GAIN	VSM gain: 000: OFF 001: 0 dB~ 111: +16dB (VSM gain is limited 1.4 Vp-p)	OFF
APACON PEAK $f_0$	APACON peak frequency: 00: 13.5 MHz 01: 9.5 MHz 10: 7.2 MHz 11: 4.5 MHz	13.5 MHz
DC REST POINT	DC restoration rate correction point: 000: 0% 111: 49%	CENTER
DC REST RATE	DC restoration correction rate: 000: 100% 111: 135% (70%)	min
DC REST LIMIT	DC restoration rate correction limit point: 00: 67% 01: 77% 10: 80% 11: 80%	min



Resister Name	Description	Preset Value
BLACK STRETCH POINT	Black stretch start point 1: 000: OFF 001: 25 IRE~ 111: 55 IRE	CENTER
APL VS BSP	Black stretch start point 2: 00: 0 IRE 11: 46 IRE up (at APL 100%)	0 IRE
B.L.C	Black level automatic correction: Up to 6.5 IRE. (Black stretch takes priority.) 0: OFF 1: ON	OFF
B.D.L.	Switches black detection level: 0: 3 IRE 1: 0 IRE	3 IRE
BS-AREA	Black stretch area reinforcement: 0: ON 1: OFF	ON
SRT-GAIN	SRT gain; Y transient improvement (LTI) 00000: min 11111: max	CENTER
WPL-LEVEL	White letters improvement amplitude; 000: min (21 IRE) ~ 110: max (102 IRE) 111: OFF	min
D-ABL POINT	Dynamic ABL detection voltage 00: min 11: max	CENTER
D-ABL GAIN	Dynamic ABL sensitivity 00: min 11: max	min
BL STRETCH POINT	Blue stretch point; B-axis correction 00: min (28 IRE) 11: max (60 IRE)	min
ABL POINT	ABL detection voltage 000: min 111: max	CENTER
ABL GAIN	ABL sensitivity 000: min 111: max	min
RGB-OUT MODE	RGB output mode; RGB output mode SW for test and adjustment 00: Normal 01: R only 10: G only 11: B only	Normal
DYNC $\gamma$ GAIN	Dynamic $\gamma$ gain vs dark area; dynamic $\gamma$ -correction according to dark area. 00:min~ 11: max (Maximum gain is +6dB included Static $\gamma$ gain for dark area.)	CENTER
BS-CHAR1/2	Black stretch characteristic swich BS-CHAR1 = 0 and BS-CHAR2 = 0: OFF BS-CHAR1 = 0 and BS-CHAR2 = 1: min BS-CHAR1 = 1 and BS-CHAR2 = 0: mid BS-CHAR1 = 1 and BS-CHAR2 = 1: max	OFF
STATIC $\gamma$ GAIN-1	Static $\gamma$ dark area gain; $\gamma$ correction for dark area 000: OFF 001: min (-5dB) ~ 11: max (+2.4dB) Note: When STATIC $\gamma$ GAIN-1 is 000(OFF), set DYNC $\gamma$ GAIN to min (00), STATIC $\gamma$ GAIN-2 to OFF (11), and DYNC $\gamma$ AREA to min (000).	OFF
STATIC $\gamma$ GAIN-2	Static $\gamma$ light area gain; $\gamma$ correction for light area 00: max (-8.8dB)~ 11: OFF When 00~10 is set, light area static $\gamma$ and light dynamic $\gamma$ according to light area is operated.	max
OSD BRIGHT	OSD brightness: 00: 5 IRE 01: 0 IRE 10: -5 IRE 11: -10 IRE	-5 IRE
OSD-CONTRAST	OSD contrast: 00: min (-9.5dB) 11: max (0dB)	min

Resister Name	Description	Preset Value
Y/C DL1/2	Adjusts Y/C phase; adjusts the phase Y before passing through matrix circuit. Y/C DL2 = 0 and Y/C DL1 = 0: -10 ns, Y/C DL2 = 0 and Y/C DL1 = 1: -5 ns Y/C DL2 = 1 and Y/C DL1 = 0: 0 ns, Y/C DL2 = 1 and Y/C DL1 = 1: +5 ns	-10 ns
DYNC $\gamma$ AREA	Dynamic $\gamma$ dark area detection sensitivity; switches detection sensitivity of dynamic $\gamma$ of dark area. 000: min~ 111: max	min
Y DETAIL CONTROL	Controls Y detail; corrects sharpness of 5.0-MHz peak frequency. 0000:min (trap) 1111: max ( +6dB )	CENTER
WP BLUE POINT	White peak blue point; 000: OFF 001: min (42 IRE) ~ 111: max (106 IRE)	OFF
Y-GROUP DELAY CORRECTION	Y group delay correction; shoot balance correction. 0000: Pre-shoot gain is lowered. (Overshoot gain is raised.) 1111: Overshoot gain is lowered. (Pre-shoot gain is raised.)	CENTER
WP BLUE GAIN	White peak blue gain. 000: min (+3dB) 111: max (+10dB)	min

**Appendix 1: Horizontal Frequency**

Pin Voltages (V)		Bus Data			H-Frequency (kHz)
Pin 55	Pin 41	00-D0	00-D7	00-D6	
DEF GND (0~1.0)	DEF V <sub>CC</sub> (8.0~9.0)	0	0	0	28.125
	6.0 (5.0~7.0)	0	0	1	31.5
	3.0 (2.0~4.0)	0	1	0	33.75
	DEF GND (0~1.0)	0	1	1	37.9
DEF V <sub>CC</sub> (8.0~9.0)	DEF V <sub>CC</sub> (8.0~9.0)	1	0	0	15.75
	6.0 (5.0~7.0)	1	0	1	31.5
	3.0 (2.0~4.0)	1	1	0	33.75
	DEF GND (0~1.0)	1	1	1	45

Note 1: Controlling pins prevails over BUS control. When the TA1360F is used for CRT, control horizontal oscillation frequency by pins 41 and 55. (See the pin descriptions for details.)

Note 2: Horizontal output frequency may not be switched at once but may takes two steps if switching pins 41 and 55 is controlled at the same time. Switching horizontal output frequency may cause deterioration of the horizontal transistor. Thus, be sure to take account of applications, included software.

**Appendix 2; Vertical Frequency**

Data	V Pull-in Range	V-BPP		Example of Format/V (H)-Frequency
		Start Phase	Stop Phase	
000	48~1281 H	1100 H	V-BLK P. (C.BLK P.) +20 H	1125P/30 Hz (33.75 kHz)
001	48~849 H	730 H		750P/60 Hz (45 kHz) (750P/50Hz(37.5 kHz))
010	48~725 H	600 H		625P/50 Hz (31.5 kHz) SVGA/60 Hz(37.9 kHz)
011	48~660 H	545 H		1125I/50 Hz (28.125 kHz) 1125I/60 Hz (33.75 kHz)
100	48~613 H	500 H		525P/60 Hz (31.5 kHz)
101	48~363 H	290 H		PAL/SECAM/50 Hz (15.625 kHz), 100 Hz (31.5 kHz)
110	48~307 H	240 H		NTSC/60 Hz (15.734 kHz), 120 Hz (31.5 kHz)
111	VP-OUT HI	—		—

### Appendix 3; Compression-BLK Phase

V-Frequency	Phase-1 (start phase) *	Phase-2 (stop phase)
000	1088 H~1116 H	50~78 H (0000: C-BLK2 OFF)
001	720 H~748 H	
010	592 H~620 H	
011	528 H~556 H	
100	488 H~516 H	
101	280 H~308 H	
110	224 H~252 H	
111	C-BLK OFF	

\*: C-BLK1 = 1111: C-BLK1 OFF

### Appendix 4; P-Mode

05-D7	1A-D1	1A-D0	MODE	Description
0	0	0	NORMAL 1	P-Mute and halftone the main signal by pin Y <sub>M</sub> . Insert analog RGB-IN by Ys3, and OSD-IN by Ys1/Ys2. Analog RGB-IN > P-Mute
0	0	1	Y-MUTE	Full-screen-mute process is executed on Y of main signal by BUS. Insert analog RGB-IN by Ys3, and OSD-IN by Ys1/Ys2. Analog RGB-IN > P-Mute
0	1	0	Y <sub>M</sub> 1	Full-screen-halftone process is executed on main signal by BUS. Insert P-Mute by pin Y <sub>M</sub> , and analog RGB-IN by Ys3. Ys1/Ys2 blends OSD-IN and main halftone signal. Analog RGB-IN > P-Mute
0	1	1	BB	Blue background process is executed on main signal by BUS. Insert P-Mute by pin Y <sub>M</sub> , analog RGB-IN by Ys3, and OSD-IN by Ys1/Ys2 Analog RGB-IN > P-Mute
1	0	0	P-MUTE 1	Full-screen-mute process is executed on main signal by BUS. Insert analog RGB-IN by Ys3, and OSD-IN by Ys1/Ys2. Analog RGB-IN > P-Mute
1	0	1	Y <sub>M</sub> 2	Full-screen-halftone process is executed on main signal by BUS. Insert P-Mute by pin Y <sub>M</sub> , and analog RGB-IN by Ys3. Ys1/Ys2 blends OSD-IN and main halftone signal P-Mute > Analog RGB-IN
1	1	0	P-MUTE 2	Full-screen-mute process is executed on main signal and analog RGB-IN by BUS. Insert OSD-IN by Ys1/Ys2. P-Mute > Analog RGB-IN
1	1	1	NORMAL 2	P-Mute and halftone process is executed on the main signal by pin Y <sub>M</sub> . Analog RGB-IN is inserted by Ys3, and OSD-IN by Ys1/Ys2. P-Mute > Analog RGB-IN

Output priority; (000)~(100): Main signal < BB < P-MUTE < RGB-IN < OSD-IN  
(101)~(111): Main signal < BB < RGB-IN < P-MUTE < OSD-IN

### Appendix 5; DR-R, DR-B/G

DR-R	DR-B/G	Reference Axis	Drive Gain1	Drive Gain2
0	0	R	G	B
0	1	R	G	B
1	0	G	R	B
1	1	B	G	R

### Read Function

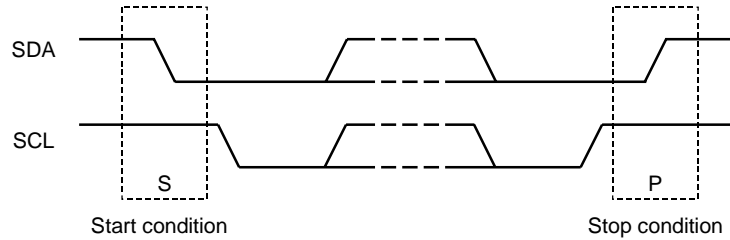
Signal	Function
POR	Power-on reset: 0: RESISTER PRESET 1: Normal After power on, 0 is returned at first read; 1, at second and subsequent reads.
IK-IN	Detects IK input; detects input through pin 8. 0: NG (no signal) 1: OK (signal detected)
RGB-OUT	Detects RGB-OUT self-check; detects output of pins 12, 13, 14. 0: NG (no signal) 1: OK (signal detected) Detects signal when all three outputs hsvc signals. Small signals are not detected.
YUV-IN	Detects YUV-IN self-check; detects input of pins 60, 61 63 or pins 66, 67, 68. 0: NG (no signal) 1: OK (signal detected) Detects signal when all three inputs are AC signals. Small signals or signals like DC voltage are not detected.
H-OUT	Detects H-OUT self-check; detects output of pin 37. 0: NG (no signal) 1: OK (signal detected)
VP-OUT	Detects VP-OUT self-check; detects output of pin 35. 0: NG (no signal) 1: OK (signal detected)
RGB-IN	Detects RGB-IN self-check; detects input of pins 24, 25, 26. 0: NG (no signal) 1: OK (signal detected) Detects signal when all three inputs are AC signals. Small signals or signals like DC voltage are not detected.
SYNC-IN	Detects SYNC-IN self-check; detects input of pin 53. 0: NG (no signal), 1: OK (signal detected)

## How to Transmit/Receive Via I<sup>2</sup>C Bus

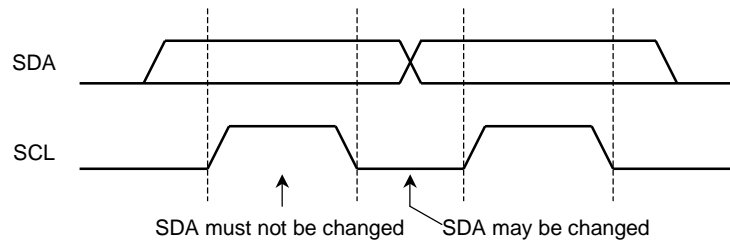
Slave Address: 88H

A6	A5	A4	A3	A2	A1	A0	W/R
1	0	0	0	1	0	0	0/1

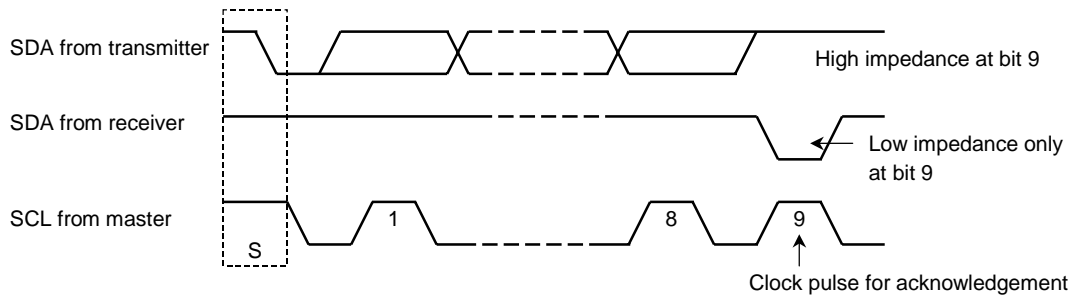
### Start and Stop Conditions



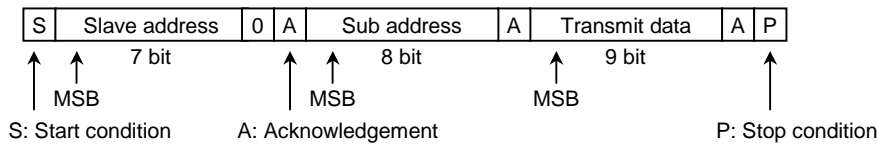
### Bit Transfer



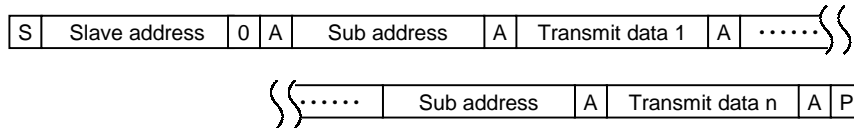
### Acknowledgement



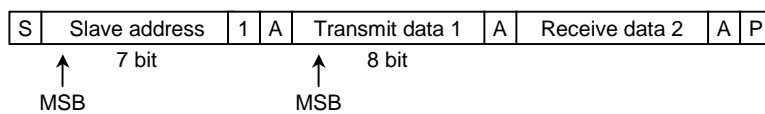
**Data Transmit Format 1**



**Data Transmit Format 2**

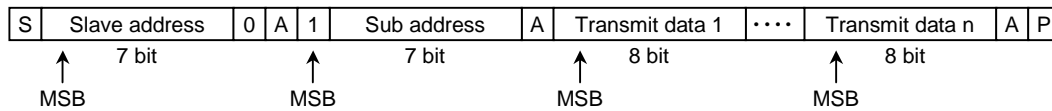


**Data Receive Format**



To receive data, the master transmitter changes to the receiver immediately after the first acknowledgement. The slave receiver changes to the transmitter. The stop condition is always created by the master. Details are provided in the Philips I<sup>2</sup>C specifications.

**Optional Data Transmit Format**



In this way, sub addresses are automatically incremented from the specified sub address and data are set. Purchase of TOSHIBA I<sup>2</sup>C components conveys a license under the Philips I<sup>2</sup>C Patent Rights to use these components in an I<sup>2</sup>C system, provided that the system conforms to the I<sup>2</sup>C Standard Specification as defined by Philips.

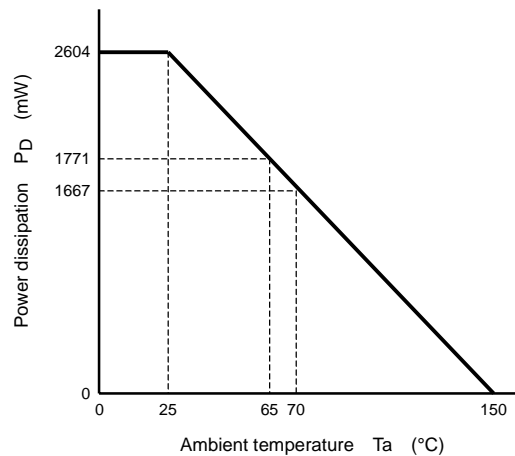
## Maximum Ratings (Ta = 25°C)

Characteristics	Symbol	Rating		Unit
Supply voltage	V <sub>CCmax</sub>	12		V
Input pin signal voltage	e <sub>inmax</sub>	9		Vp-p
Power dissipation	P <sub>D</sub> (Note 3)	2604		mW
Power dissipation reduction rate depending on temperature	1/θ <sub>ja</sub>	20.8		mW/°C
Operating temperature	T <sub>opr</sub>	-20 to 65	-20 to 70	°C
Storage temperature	T <sub>stg</sub>	-55 to 150		°C
Supply voltage (pins 16, 45 and 75)	min	8.7	8.5	V
	typ.	9.0	8.8	
	max	9.3	9.1	

Note 3: See the following Figure A. (With device mounted on a PCB whose dimensions are 114.3 mm × 76.2 mm × 1.6 mm and whose surface is 20% copper. Mount the device on a PCB of at least these dimensions and whose surface is at least 20% copper.)

When using in -25 to 70°C of operating temperature, set the IC's power supply voltage (pins 16, 45, 75) to 8.8 V (±0.3 V).

When designing a set, make sure that the IC can radiate heat because the TA1360AFG has low thermal capacity. Note that the power dissipation varies greatly according to conditions of a board.



**Figure A Power Dissipation Reduction Curve**



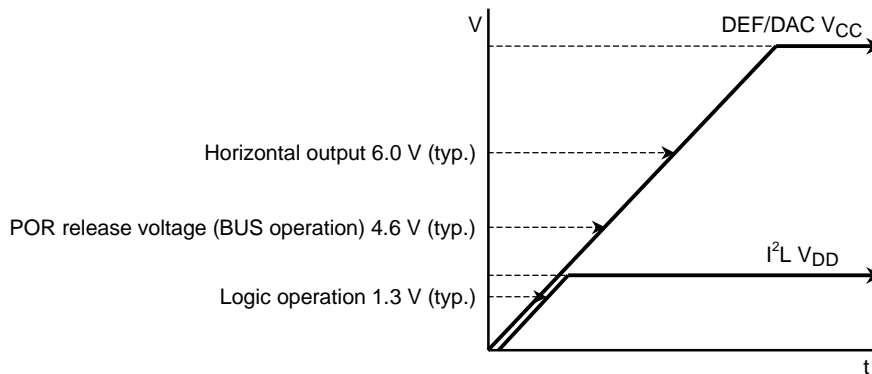
## Note 4: Power supply sequence

At power-on, power should be supplied to the power supply pins according to the following sequence:

1. Pin 31 ( $I^2L$  V<sub>DD</sub>)
2. Pin 45 (DEF/DAC V<sub>CC</sub>)
3. Pins 16 and 75 (YC V<sub>CC</sub>/RGB V<sub>CC</sub>)

Supply power to pin 37 via zener diode through resistor from pin 45. (See "Application Circuit".)

BUS preset value is become undefined and caused malfunction of the IC unless supplying power to all supply pins or follow the power supply sequence described above. When the frequency of horizontal output (pin 37) became undefined, horizontal transistor may be damaged. When the TA1360F is used for CRT, control horizontal oscillation frequency by pins 41 and 55.



**Figure B** Timing chart that indicates the timing from power-on till horizontal output. (At  $T_a = 25\text{ C}^\circ$ )

## Operating Conditions

Characteristics	Description		Min	Typ.	Max	Unit	
Supply voltage (V <sub>CC</sub> )	Pin 16, 45, 75	T <sub>opr</sub> = -20 to 65°C (Note 5)	8.7	9.0	9.3	V	
		T <sub>opr</sub> = -20 to 70°C (Note 5)	8.5	8.8	9.1		
	Pin 31		1.8	2.0	2.2		
Y input level	Pins 63, 68: 100% color bar, including sync (Picture period amplitude, 0.7 V <sub>p-p</sub> )		—	1.0	—	V <sub>p-p</sub>	
Color-difference input level	Pins 60, 61 66, 67: 100% color bar, not including sync		—	0.7	—		
HD/VD input level	Pins 50, 52		2.0	5.0	V <sub>CC</sub>	V	
SYNC input level	Pin 53: 100% color bar, including sync		0.9	1.0	1.1	V <sub>p-p</sub>	
SCP input level	Pin 49	CP	4.2	5.0	V <sub>CC</sub>	V	
		BPP	2.2	2.5	2.8		
Horizontal frequency switching voltage	Pin 55	At 28 k/31 k/33 k/37 kHz	0	0	1.0		
		At 15 k/31 k/33 k/45 kHz	8.0	V <sub>CC</sub>	V <sub>CC</sub>		
	Pin 41	28.125 kHz or 15.75 kHz	8.0	V <sub>CC</sub>	V <sub>CC</sub>		
		31.5 kHz	5.0	6.0	7.0		
		33.75 kHz	2.0	3.0	4.0		
FBP input level	Pin 39	H-AFC	6.5	7.0	V <sub>CC</sub>		
		H-BLK	3.0	3.5	4.0		
FBP input width	Pin 39		0.16	—	0.3		H
H-OUT input current	Pin 37		—	9.0	15.0		mA
DAC input current	Pins 23, 34		—	0.3	1.0		
SCL/SDA pull-up voltage	Pins 28, 30		3.3	5.0	V <sub>CC</sub>	V	
SDA input current	Pin 28		—	—	2	mA	
Analog RGB input level	Pins 24, 25, 26: White 100%		—	0.7	—	V <sub>p-p</sub>	
Analog OSD input level	Pins 18, 19, 21: White 100%		—	0.7	—		
Y <sub>S3</sub> switching voltage	Pin 2		1.5	5.0	V <sub>CC</sub>	V	
Y <sub>S1/2</sub> switching voltage	Pins 1, 80	OSD	2.9	5.0	V <sub>CC</sub>		
		VSM MUTE	1.1	1.5	1.7		
Y <sub>M</sub> switching voltage	Pin 79	BLK	7.0	V <sub>CC</sub>	V <sub>CC</sub>		
		P-MUTE	2.7	3.5	4.0		
		HALF TONE	1.2	1.5	1.8		
External V-BLK input current	Pin 35		0.78	—	1	mA	

Note 5: See "Maximum Ratings" about T<sub>opr</sub>.

## Electrical Characteristics (unless otherwise specified, V<sub>CC</sub> = 9 V/2 V, Ta = 25°C)

### Current Dissipation

Pin Name	Symbol	Test Circuit	Min	Typ.	Max	Unit
DEF/DAC V <sub>CC</sub> (9 V)	I <sub>CC1</sub>	—	19.2	24.0	28.2	mA
RGB V <sub>CC</sub> (9 V)	I <sub>CC2</sub>	—	48.8	61.0	67.8	
I <sup>2</sup> L V <sub>DD</sub> (2 V)	I <sub>CC3</sub>	—	21.3	25.0	29.4	
Y/C V <sub>CC</sub> (9 V)	I <sub>CC4</sub>	—	36.8	46.0	51.1	

## Pin Voltage

### Test Condition

- (1) BUS = Preset
- (2) SW71 = B, SW70 = B, SW68 = C, SW67 = B, SW66 = B, SW64 = B, SW63 = B, SW60 to 61 = B,  
SW53 = B, SW44 = ON, SW40 = B, SW39 = A, SW37 = A, SW24 to 26 = A, SW21 = A, SW18-19 = A,  
SW77 = OFF, SW74 = ON

Pin No.	Pin Name	Symbol	Test Circuit	Min	Typ.	Max	Unit
1	Y <sub>S</sub> 2	V <sub>1</sub>	—	—	0.1	0.2	V
2	Y <sub>S</sub> 3	V <sub>2</sub>	—	—	0.1	0.2	
4	R S/H	V <sub>4</sub>	—	4.2	5.2	6.2	
6	G S/H	V <sub>6</sub>	—	4.2	5.2	6.2	
7	B S/H	V <sub>7</sub>	—	4.2	5.2	6.2	
18	ANALOG OSD R IN	V <sub>18</sub>	—	3.65	3.95	4.25	
19	ANALOG OSD G IN	V <sub>19</sub>	—	3.65	3.95	4.25	
21	ANALOG OSD B IN	V <sub>21</sub>	—	3.65	3.95	4.25	
24	ANALOG R IN	V <sub>24</sub>	—	3.65	3.95	4.25	
25	ANALOG G IN	V <sub>25</sub>	—	3.65	3.95	4.25	
26	ANALOG B IN	V <sub>26</sub>	—	3.65	3.95	4.25	
40	H CURVE CORRECTION	V <sub>40</sub>	—	2.2	2.5	2.8	
42	HVCO	V <sub>42</sub>	—	4.4	5.0	5.6	
44	AFC FILTER	V <sub>44</sub>	—	5.4	6.2	7.0	
49	CP IN	V <sub>49</sub>	—	—	0	0.3	
50	HD IN	V <sub>50</sub>	—	—	0	0.3	
52	VD IN	V <sub>52</sub>	—	—	0	0.3	
53	SYNC IN	V <sub>53</sub>	—	1.8	2.1	2.4	
57	VSM FILTER	V <sub>57</sub>	—	7.5	7.7	7.9	
58	COLOR LIMITER	V <sub>58</sub>	—	6.65	6.9	7.15	
60	Cr/Pr2 IN	V <sub>60</sub>	—	4.7	5.0	5.3	
61	Cb/Pb2 IN	V <sub>61</sub>	—	4.7	5.0	5.3	
63	Y2 IN	V <sub>63</sub>	—	4.7	5.0	5.3	
64	LIGHT AREA DET FILTER	V <sub>64</sub>	—	—	0.09	0.15	
66	Cr/Pr1 IN	V <sub>66</sub>	—	4.7	5.0	5.3	
67	Cb/Pb1 IN	V <sub>67</sub>	—	4.7	5.0	5.3	
68	Y1 IN	V <sub>68</sub>	—	4.7	5.0	5.3	
70	BPH FILTER	V <sub>70</sub>	—	5.5	5.8	6.1	
71	DARK AREA DET FILTER	V <sub>71</sub>	—	—	0.09	0.15	
74	APL FILTER	V <sub>74</sub>	—	4.8	5.0	5.2	
77	VSM OUT	V <sub>77</sub>	—	4.1	4.3	4.5	
78	ABCL IN	V <sub>78</sub>	—	6.1	6.35	6.6	
79	Y <sub>M</sub>	V <sub>79</sub>	—	—	0.1	0.2	
80	Y <sub>S</sub> 1	V <sub>80</sub>	—	—	0.1	0.2	

## Picture Quality (Sharpness) Block

Characteristics	Symbol	Test Circuit	Test Condition	Min	Typ.	Max	Unit
Y input dynamic range	D <sub>RY</sub>	—	—	0.7	1.0	1.5	Vp-p
Black detection level shift	V <sub>B</sub>	—	(Note P01)	-15	10	15	mV
	V <sub>B3</sub>	—		35	45	55	
Black stretch amp maximum gain	G <sub>BS</sub>	—	(Note P02)	2.4	2.8	3.2	dB
Black stretch start point 1	P <sub>BST1</sub>	—	(Note P03)	20	25	35	IRE
	P <sub>BST2</sub>	—		50	55	60	
Black stretch start point 2	P <sub>BS1</sub>	—	(Note P04)	0	5	10	IRE
	P <sub>BS2</sub>	—		14	21	30	
Black stretch characteristic switch	P <sub>BSC1</sub>	—	(Note P05)	26	28	30	IRE
	P <sub>BSC2</sub>	—		-8	-6	-4	
	P <sub>BSC3</sub>	—		26	28	30	
	P <sub>BSC4</sub>	—		-5.5	-3	-1	
	P <sub>BSC5</sub>	—		26	28	30	
	P <sub>BSC6</sub>	—		-3.5	-2	-0.5	
Black stretch area reinforcement current	IBSA	—	(Note P06)	13	18	23	μA
D.ABL detection voltage	DV <sub>01</sub>	—	(Note P07)	80	120	160	mV
	DV <sub>10</sub>	—		240	280	320	
	DV <sub>11</sub>	—		380	420	460	
D.ABL sensitivity	S <sub>DAMIN</sub>	—	(Note P08)	—	0.01	0.02	V/V
	S <sub>DAMAX</sub>	—		0.25	0.28	0.31	
Black level correction	BLC	—	(Note P09)	4.5	6.5	8.5	IRE
Dark area Y <sub>γ</sub> correction point	P <sub>DGP</sub>	—	(Note P10)	25	28	33	IRE
Dark area dynamic Y <sub>γ</sub> gain	G <sub>DDGMAX</sub>	—	(Note P11)	5.5	6	6.5	dB
Dark area static Y <sub>γ</sub> gain	G <sub>DSGMIN</sub>	—	(Note P12)	-6.5	-5	-4	dB
	G <sub>DSGMAX</sub>	—		2	2.4	2.6	
Light area Y <sub>γ</sub> correction point	LPG	—	(Note P13)	64	74	80	IRE
Light area dynamic Y <sub>γ</sub> gain	GLDG	—	(Note P14)	1.1	1.7	2.3	dB
Light area static Y <sub>γ</sub> gain	GLSGMIN	—	(Note P15)	0.3	0.6	0.9	dB
	GLSGMAX	—		1.4	1.7	2.3	
Dark area detection sensitivity	D <sub>AMIN</sub>	—	(Note P16)	0.25	0.3	0.37	V
	D <sub>ACEN</sub>	—		0.88	0.98	1.08	
	D <sub>AMAX</sub>	—		0.95	1.05	1.15	
DC restoration rate	ADT <sub>100</sub>	—	(Note P17)	0.9	1.1	1.2	times
	ADT <sub>135</sub>	—		1.2	1.35	1.5	
	ADT <sub>65</sub>	—		0.55	0.70	0.85	
DC restoration point	V <sub>DT0</sub>	—	(Note P18)	-5	0	5	%
	V <sub>DT1</sub>	—		47	49	55	
DC restoration limit	P <sub>DTL60</sub>	—	(Note P19)	64	67	70	%
	P <sub>DTL75</sub>	—		74	77	80	
	P <sub>DTL87</sub>	—		74	80	82	
	P <sub>DTL100</sub>	—		74	80	82	

Characteristics	Symbol	Test Circuit	Test Condition	Min	Typ.	Max	Unit
Sharpness control peak frequency	FAP00	—	—	10.5	13.5	17	MHz
	FAP01	—		7	9.5	12	
	FAP10	—		5	7.2	7.8	
	FAP11	—		3.5	4.5	6.3	
DC fluctuation at switching sharpness control peak frequency	VRDC	—	(Note P20)	—	0.01	0.02	V
Sharpness control range	GMAX00	—	(Note P21)	15	17.5	19	dB
	GMIN00	—		-4	-0.6	2.5	
	GMAX01	—		15	17.5	19	
	GMIN01	—		-5	-0.3	2.5	
	GMAX10	—		15	17.5	19	
	GMIN10	—		-7	-2.5	1.5	
	GMAX11	—		15	17.5	19	
	GMIN11	—		-12	-5	0	
Sharpness control center characteristic	GCEN00	—	(Note P22)	7	10	13	dB
	GCEN01	—		7	10	13	
	GCEN10	—		7	10	13	
	GCEN11	—		7	10	13	
2T pulse response SRT control	TSRT00	—	(Note P23)	0.9	1.6	2.7	dB
	TSRT01	—		3.5	4.8	7.1	
	TSRT10	—		6.7	8.5	11.3	
	TSRT11	—		11.5	12.5	15.5	
VSM peak frequency	FVSM	—	—	19	19.5	25.5	MHz
VSM gain	GV000	—	(Note P24)	—	-40	-35	dB
	GV001	—		-2	-1.2	-0.4	
	GV010	—		3.7	4.6	5.5	
	GV011	—		7.1	8.2	9.3	
	GV100	—		8.9	10.5	12.1	
	GV101	—		11.4	12.6	13.8	
	GV110	—		13.5	14.4	15.3	
	GV111	—		14.8	15.7	16.6	
VSM mute threshold voltage	VSR1	—	Pins 1, 2, 80	0.62	0.78	0.85	V
	VSR2	—		0.62	0.78	0.85	
	VSR580	—		0.62	0.78	0.85	
VSM limit	VLU	—	(Note P25)	0.55	0.66	0.75	Vp-p
	ULD	—		0.55	0.66	0.75	
Y input to R output delay time	TYR	—	—	110	125	140	ns
Y delay time switch	YDLA	—	(Note P26)	3	5	10	ns
	YDLB	—		7	10	15	
	YDLC	—		10	15	25	
Y group delay correction	GAMIN	—	(Note P27)	-4	-2.5	-1	dB
	GBMIN	—		2.5	3	3.5	
	GAMAX	—		1	1.7	2.4	
	GBMAX	—		-5	-4	-2	

Characteristics	Symbol	Test Circuit	Test Condition	Min	Typ.	Max	Unit
Color detail enhancer	G <sub>CDE00</sub>	—	(Note P28)	9	10	11	dB
	G <sub>CDE01</sub>	—		9	10	11	
	G <sub>CDE10</sub>	—		9	10	11	
	G <sub>CDE11</sub>	—		9	10	11	
Y detail frequency	F <sub>YD</sub>	—	—	4	5	6	MHz
Y detail control range	G <sub>YD</sub> MAX	—	(Note P29)	11	13	15	dB
	G <sub>YD</sub> CEN	—		8	10	12	
	G <sub>YD</sub> MIN	—		3	5	7	

## Color Difference Block 1: YUV input and matrix

Characteristics	Symbol	Test Circuit	Test Condition	Min	Typ.	Max	Unit
Color difference input dynamic range	D <sub>RB</sub>	—	—	0.7	0.9	1.0	V <sub>p-p</sub>
	D <sub>RR</sub>	—		0.7	0.9	1.0	
Color difference tint control characteristic	T <sub>RMAX</sub>	—	—	25	29	33	°
	T <sub>RMIN</sub>	—		-37	-33	-29	
	T <sub>BMAX</sub>	—		27	31	35	
	T <sub>BMIN</sub>	—		-36	-32	-28	
Color SRT peak frequency	F <sub>B00</sub>	—	—	3.6	4.5	5.4	MHz
	F <sub>B01</sub>	—		4.6	5.8	7.0	
	F <sub>R00</sub>	—		3.6	4.5	5.4	
	F <sub>R01</sub>	—		4.6	5.8	7.0	
Color SRT gain	G <sub>S<sub>B00</sub>CEN</sub>	—	(Note S01)	1.5	2.8	4.1	dB
	G <sub>S<sub>B00</sub>MAX</sub>	—		2.9	4.2	5.5	
	G <sub>S<sub>B01</sub>CEN</sub>	—		2.0	3.3	4.6	
	G <sub>S<sub>B01</sub>MAX</sub>	—		3.5	4.8	6.1	
	G <sub>S<sub>R00</sub>CEN</sub>	—		3.4	4.7	6.0	
	G <sub>S<sub>R00</sub>MAX</sub>	—		5.4	6.7	7.0	
	G <sub>S<sub>R01</sub>CEN</sub>	—		3.1	4.4	5.7	
	G <sub>S<sub>R01</sub>MAX</sub>	—		5.2	6.5	7.8	
Cb1 input to B output delay time	T <sub>B</sub>	—	—	130	155	185	ns
Cr1 input to R output delay time	T <sub>R</sub>	—	—	130	155	185	ns
Dynamic Y/C compensation	G <sub>CBDY1</sub>	—	(Note S02)	1.8	2.25	2.7	dB
	G <sub>CBDY2</sub>	—		-1.65	-1.2	-0.75	
	G <sub>CRDY1</sub>	—		1.8	2.25	2.7	
	G <sub>CRDY2</sub>	—		-1.65	-1.2	-0.75	
YUV gain	G <sub>Y00</sub>	—	(Note S03)	2.4	3.4	4.4	dB
	G <sub>Y01</sub>	—		2.4	3.4	4.4	
	G <sub>CBB</sub>	—		9.5	11.0	12.5	
	G <sub>PBB</sub>	—		9.9	11.4	12.9	
	G <sub>PBR</sub>	—		-18.0	-16.0	-14.0	
	G <sub>CRR</sub>	—		9.5	11.0	12.5	
	G <sub>PRB</sub>	—		-15.0	-13.5	-12.0	
	G <sub>PRR</sub>	—		10.0	11.5	13.0	

Characteristics	Symbol	Test Circuit	Test Condition	Min	Typ.	Max	Unit
Green stretch	GrA01	—	(Note S04)	0.98	1	1.02	times
	GrA10	—		0.95	1	1.05	
	GrA11	—		0.93	1	1.07	
	GrB01	—		1.01	1.05	1.10	
	GrB10	—		1.05	1.1	1.15	
	GrB11	—		1.12	1.19	1.26	
	GrC01	—		1.10	1.14	1.18	
	GrC10	—		1.23	1.27	1.31	
	GrC11	—		1.35	1.42	1.49	
	GrD01	—		1.09	1.13	1.17	
	GrD10	—		1.21	1.25	1.29	
	GrD11	—		1.32	1.39	1.46	
	GrE01	—		0.98	1	1.02	
	GrE10	—		0.95	1	1.05	
	GrE11	—		0.93	1	1.07	



## Color Difference Block 2

Characteristics	Symbol	Test Circuit	Test Condition	Min	Typ.	Max	Unit
Color difference contrast adjustment characteristic	$\Delta V_{uCY}$	—	(Note A01)	14.5	16.0	17.5	dB
Color adjustment characteristic	$\Delta v_{cCY+}$	—	(Note A02)	3.0	4.0	5.0	dB
	$\Delta v_{cCY-}$	—		-35	-22	-17	
R-Y relative phase and amplitude	$\theta_{RMAX}$	—	—	109	111.5	114	°
	$\theta_{RCNT}$	—		98.5	101	103.5	
	$\theta_{RMIN}$	—		88	90	92	
	$V_R/V_{BMAX}$	—		0.86	0.90	0.94	times
	$V_R/V_{BCNT}$	—		0.65	0.69	0.73	
	$V_R/V_{BMIN}$	—		0.42	0.45	0.49	
G-Y relative phase and amplitude	$\theta_{GMAX}$	—	—	251	254	257	°
	$\theta_{GCNT}$	—		244	247	250	
	$\theta_{GMIN}$	—		229	232	235	
	$V_G/V_{BMAX}$	—		0.43	0.48	0.53	times
	$V_G/V_{BCNT}$	—		0.33	0.37	0.41	
	$V_G/V_{BMIN}$	—		0.22	0.25	0.28	
Color difference halftone characteristic	$GHT_{RY}$	—	(Note A03)	0.47	0.50	0.53	times
	$GHT_{GY}$	—		0.47	0.50	0.53	
	$GHT_{BY}$	—		0.47	0.50	0.53	
Color $\gamma$ characteristic	$V_{\gamma 1}$	—	(Note A04)	0.09	0.23	0.37	Vp-p
	$V_{\gamma 2}$	—		0.26	0.40	0.54	
	$V_{\gamma 3}$	—		0.44	0.58	0.72	
	$\Delta\gamma$	—		0.60	0.70	0.80	—
Color limiter characteristic	$CLT_0$	—	(Note A05)	1.45	1.65	1.85	Vp-p
	$CLT_1$	—		1.80	2.00	2.20	
High-bright color gain	$HBC_1$	—	(Note A06)	0.02	0.04	0.06	times

## Text Block

Characteristics	Symbol	Test Circuit	Test Condition	Min	Typ.	Max	Unit
AC gain (Y1in~R/G/B out)	G <sub>R</sub>	—	(Note T01)	3.08	3.45	3.90	times
	G <sub>G</sub>	—		3.08	3.45	3.90	
	G <sub>B</sub>	—		3.08	3.45	3.90	
AC gain axis difference	G <sub>G/R</sub>	—	—	0.94	1.00	1.06	
	G <sub>B/R</sub>	—		0.94	1.00	1.06	
Frequency characteristic (Y1in~R/G/B out)	G <sub>fR</sub>	—	At -3dB, sharpness characteristic is flat	30	60	—	MHz
	G <sub>fG</sub>	—		30	60	—	
	G <sub>fB</sub>	—		30	60	—	
Frequency characteristic (Cb1/Cr1in~R/G/B out)	G <sub>fCb</sub>	—	—	10	12.5	—	MHz
	G <sub>fCr</sub>	—		10	12.5	—	
Unicolor adjustment characteristic	ΔV <sub>u</sub>	—	(Note T02)	15.0	16.0	17.0	dB
Brightness adjustment characteristic	V <sub>brMAX</sub>	—	(Note T03)	4.10	4.45	4.80	V
	V <sub>brCNT</sub>	—		3.05	3.40	3.75	
	V <sub>brMIN</sub>	—		1.95	2.30	2.65	
White peak slice level	V <sub>wps1</sub>	—	(Note T04)	2.20	2.32	2.44	Vp-p
	V <sub>wps2</sub>	—		2.59	2.74	2.89	
Black peak slice level	V <sub>bps</sub>	—	(Note T05)	1.15	1.35	1.45	V
RGB output S/N	N <sub>12</sub>	—	(Note T06)	—	-52	-46	dB
	N <sub>13</sub>	—		—	-52	-46	
	N <sub>14</sub>	—		—	-52	-46	
Halftone characteristic	G <sub>HT1</sub>	—	(Note T07)	0.45	0.50	0.55	times
	G <sub>HT2</sub>	—		0.45	0.50	0.55	
Halftone on voltage	V <sub>HT</sub>	—	Pin 79	0.65	0.85	1.05	V
V-BLK pulse output level	V <sub>VR</sub>	—	—	0.30	0.80	1.30	V
	V <sub>VG</sub>	—		0.30	0.80	1.30	
	V <sub>VB</sub>	—		0.30	0.80	1.30	
H-BLK pulse output level	V <sub>HR</sub>	—	—	0.30	0.80	1.30	V
	V <sub>HG</sub>	—		0.30	0.80	1.30	
	V <sub>HB</sub>	—		0.30	0.80	1.30	
BLK pulse delay time	td <sub>ON</sub>	—	(Note T08)	—	0.00	0.30	μs
	td <sub>OFF</sub>	—		—	0.08	0.30	
Sub-contrast variable range	ΔV <sub>su+</sub>	—	—	1.95	2.45	2.95	dB
	ΔV <sub>su-</sub>	—		-3.8	-3.3	-2.8	
Cut-off voltage variable range	CUT+	—	—	0.42	0.47	0.52	V
	CUT-	—		0.42	0.47	0.52	
RGB output voltage	ΔV <sub>#12</sub>	—	—	2.05	2.30	2.55	V
	ΔV <sub>#13</sub>	—		2.05	2.30	2.55	
	ΔV <sub>#14</sub>	—		2.05	2.30	2.55	
RGB output voltage 3-axis difference	ΔV <sub>OUT</sub>	—	—	—	0	150	mV

Characteristics	Symbol	Test Circuit	Test Condition	Min	Typ.	Max	Unit
Drive adjustment variable range	DR <sub>R1+</sub>	—	(Note T09)	2.5	3.0	3.5	dB
	DR <sub>R1-</sub>	—		-5.5	-5.0	-4.5	
	DR <sub>R2+</sub>	—		2.5	3.0	3.5	
	DR <sub>R2-</sub>	—		-5.5	-5.0	-4.5	
	DR <sub>G1+</sub>	—		2.5	3.0	3.5	
	DR <sub>G1-</sub>	—		-5.5	-5.0	-4.5	
	DR <sub>G2+</sub>	—		2.5	3.0	3.5	
	DR <sub>G2-</sub>	—		-5.5	-5.0	-4.5	
	DR <sub>G3+</sub>	—		2.5	3.0	3.5	
	DR <sub>G3-</sub>	—		-5.5	-5.0	-4.5	
	DR <sub>B1+</sub>	—		2.5	3.0	3.5	
	DR <sub>B1-</sub>	—		-5.5	-5.0	-4.5	
	DR <sub>B2+</sub>	—		2.5	3.0	3.5	
	DR <sub>B2-</sub>	—		-5.5	-5.0	-4.5	
	DR <sub>B3+</sub>	—		2.5	3.0	3.5	
	DR <sub>B3-</sub>	—		-5.5	-5.0	-4.5	
Output voltage at P-mute	MURD	—	—	1.7	1.85	2.0	V
	MUGD	—		1.7	1.85	2.0	
	MUBD	—		1.7	1.85	2.0	
P-mute ON voltage	V <sub>MUTE</sub>	—	Pin 79	1.90	2.15	2.40	V
Output voltage at blue background	BB <sub>R</sub>	—	—	1.0	1.2	1.4	V
	BB <sub>G</sub>	—		1.0	1.2	1.4	
	BB <sub>B</sub>	—		1.1	1.25	1.4	V <sub>p-p</sub>
Input impedance of #78	Z <sub>in</sub>	—	(Note T10)	24	30	36	kΩ
ACL characteristic	ACL <sub>1</sub>	—	(Note T11)	-6.5	-4.5	-2.5	dB
	ACL <sub>2</sub>	—		-15.0	-13.5	-11.0	
ABL point	ABL <sub>P1</sub>	—	(Note T12)	-0.21	-0.16	-0.11	V
	ABL <sub>P2</sub>	—		-0.28	-0.23	-0.18	
	ABL <sub>P3</sub>	—		-0.37	-0.32	-0.27	
	ABL <sub>P4</sub>	—		-0.45	-0.40	-0.35	
	ABL <sub>P5</sub>	—		-0.54	-0.49	-0.44	
	ABL <sub>P6</sub>	—		-0.62	-0.57	-0.52	
	ABL <sub>P7</sub>	—		-0.70	-0.65	-0.60	
	ABL <sub>P8</sub>	—		-0.75	-0.70	-0.65	
ABL gain	ABL <sub>G1</sub>	—	(Note T13)	-0.06	-0.02	0.00	V
	ABL <sub>G2</sub>	—		-0.17	-0.12	-0.07	
	ABL <sub>G3</sub>	—		-0.34	-0.29	-0.24	
	ABL <sub>G4</sub>	—		-0.52	-0.47	-0.42	
	ABL <sub>G5</sub>	—		-0.68	-0.63	-0.59	
	ABL <sub>G6</sub>	—		-0.85	-0.80	-0.75	
	ABL <sub>G7</sub>	—		-1.01	-0.96	-0.91	
	ABL <sub>G8</sub>	—		-1.09	-1.04	-0.99	

Characteristics	Symbol	Test Circuit	Test Condition	Min	Typ.	Max	Unit	
RGB output mode	V <sub>12R</sub>	—	(Note T14)	2.15	2.40	2.65	V	
	V <sub>13R</sub>	—		0.30	0.80	1.30		
	V <sub>14R</sub>	—		0.30	0.80	1.30		
	V <sub>12G</sub>	—		0.30	0.80	1.30		
	V <sub>13G</sub>	—		2.15	2.40	2.65		
	V <sub>14G</sub>	—		0.30	0.80	1.30		
	V <sub>12B</sub>	—		0.30	0.80	1.30		
	V <sub>13B</sub>	—		0.30	0.80	1.30		
Y-OUT $\gamma$ characteristic	V <sub>14B</sub>	—	(Note T15)	2.15	2.40	2.65	V	
	$\gamma_1$	—		56	66	76		IRE
	$\gamma_2$	—		72	82	92		
	$\Delta_1$	—		0.49	1.24	1.99		dB
	$\Delta_2$	—		-1.67	-0.92	-0.17		
$\Delta_3$	—	-4.59	-3.84	-3.09				
White-peak blue characteristic	BSP <sub>min</sub>	—	(Note T16)	37	42	47	IRE	
	BSP <sub>cnt</sub>	—		72	77	82		
	BSP <sub>max</sub>	—		101	106	111		
	BSG <sub>min</sub>	—		2.1	3.1	4.1	dB	
	BSG <sub>cnt</sub>	—		6.4	7.4	8.4		
	BSG <sub>max</sub>	—		9	10	11		
Forced BLK input threshold voltage	V <sub>BLKIN</sub>	—	Pin 79	5.1	5.6	6.1	V	
ACB insertion pulse phase and amplitude	$\theta_{ACBR}$	—	(Note T17)	—	1	—	H	
	$\theta_{ACBG}$	—		—	2	—		
	$\theta_{ACBB}$	—		—	3	—		
	V <sub>ACB1R</sub>	—		0.15	0.20	0.25	Vp-p	
	V <sub>ACB1G</sub>	—		0.15	0.20	0.25		
	V <sub>ACB1B</sub>	—		0.15	0.20	0.25		
	V <sub>ACB2R</sub>	—		0.27	0.32	0.37		
	V <sub>ACB2G</sub>	—		0.27	0.32	0.37		
	V <sub>ACB2B</sub>	—		0.27	0.32	0.37		
	V <sub>ACB3R</sub>	—		0.52	0.57	0.62		
	V <sub>ACB3G</sub>	—		0.52	0.57	0.62		
	V <sub>ACB3B</sub>	—		0.52	0.57	0.62		
IK input amplitude	IK <sub>R</sub>	—	(Note T18)	0.73	0.93	1.13		Vp-p
	IK <sub>G</sub>	—		0.73	0.93	1.13		
	IK <sub>B</sub>	—		0.73	0.93	1.13		
IK input cover range	DIK <sub>in+</sub>	—	(Note T19)	3.00	3.30	3.60	V	
	DIK <sub>in-</sub>	—		-0.50	-0.30	-0.10		

Characteristics	Symbol	Test Circuit	Test Condition	Min	Typ.	Max	Unit
Analog RGB gain	G <sub>TXR</sub>	—	(Note T20)	3.03	3.40	3.83	times
	G <sub>TXG</sub>	—		3.03	3.40	3.83	
	G <sub>TXB</sub>	—		3.03	3.40	3.83	
Analog RGB gain 3-axis difference	G <sub>TXG/R</sub>	—	—	0.94	1.00	1.06	—
	G <sub>TXB/R</sub>	—		0.94	1.00	1.06	
Analog RGB frequency characteristic	G <sub>fTXR</sub>	—	At -3dB	30	35	—	MHz
	G <sub>fTXG</sub>	—		30	35	—	
	G <sub>fTXB</sub>	—		30	35	—	
Analog RGB input dynamic range	DR <sub>24</sub>	—	—	0.80	1.20	1.50	Vp-p
	DR <sub>25</sub>	—		0.80	1.20	1.50	
	DR <sub>26</sub>	—		0.80	1.20	1.50	
Analog RGB white peak slice level	TXV <sub>WPSR</sub>	—	(Note T21)	2.45	2.70	2.95	Vp-p
	TXV <sub>WPSG</sub>	—		2.45	2.70	2.95	
	TXV <sub>WPSB</sub>	—		2.45	2.70	2.95	
Analog RGB black peak limit level	V <sub>BPSR</sub>	—	(Note T22)	1.15	1.30	1.45	V
	V <sub>BPSG</sub>	—		1.15	1.30	1.45	
	V <sub>BPSB</sub>	—		1.15	1.30	1.45	
RGB contrast adjustment characteristic	ΔV <sub>uTXR</sub>	—	(Note T23)	15.5	16.5	18.5	dB
	ΔV <sub>uTXG</sub>	—		15.5	16.5	18.5	
	ΔV <sub>uTXB</sub>	—		15.5	16.5	18.5	
Analog RGB bright adjustment characteristic	V <sub>brTXmax</sub>	—	(Note T24)	3.0	3.2	3.4	V
	V <sub>brTXcnt</sub>	—		2.6	2.8	3.0	
	V <sub>brTXmin</sub>	—		2.1	2.3	2.5	
Analog RGB mode switching voltage	V <sub>TXON</sub>	—	Pin 2	0.65	0.85	1.05	V
Analog RGB mode switching transfer characteristic	τ <sub>RYS</sub>	—	(Note T25)	—	15	50	ns
	t <sub>PRYS</sub>	—		—	20	50	
	Δt <sub>RYS</sub>	—		—	0	10	
	τ <sub>FYS</sub>	—		—	10	50	
	t <sub>PRYS</sub>	—		—	30	50	
	Δt <sub>RYS</sub>	—		—	0	10	
Text ACL characteristic	TXACL <sub>1</sub>	—	(Note T26)	-6.7	-4.7	-2.7	dB
	TXACL <sub>2</sub>	—		-16.5	-14.5	-12.5	
Analog OSD gain	G <sub>OSDR</sub>	—	(Note T27)	2.95	3.30	3.70	times
	G <sub>OSDG</sub>	—		2.95	3.30	3.70	
	G <sub>OSDB</sub>	—		2.95	3.30	3.70	
Analog OSD gain 3-axis difference	G <sub>OSDG/R</sub>	—	—	0.94	1.00	1.06	—
	G <sub>OSDB/R</sub>	—		0.94	1.00	1.06	
Analog OSD frequency characteristic	G <sub>fOSDR</sub>	—	At -3dB	35	40	—	MHz
	G <sub>fOSDG</sub>	—		35	40	—	
	G <sub>fOSDB</sub>	—		35	40	—	
Analog OSD input dynamic range	DR <sub>18</sub>	—	—	0.80	1.20	1.50	Vp-p
	DR <sub>19</sub>	—		0.80	1.20	1.50	
	DR <sub>21</sub>	—		0.80	1.20	1.50	

Characteristics	Symbol	Test Circuit	Test Condition	Min	Typ.	Max	Unit	
Analog OSD input white peak slice level	OSDV <sub>WPSR</sub>	—	(Note T28)	2.45	2.70	2.95	Vp-p	
	OSDV <sub>WPSG</sub>	—		2.45	2.70	2.95		
	OSDV <sub>WPSB</sub>	—		2.45	2.70	2.95		
Analog OSD black peak limit level	OSDV <sub>BPSR</sub>	—	(Note T29)	1.30	1.45	1.60	V	
	OSDV <sub>BPSG</sub>	—		1.30	1.45	1.60		
	OSDV <sub>BPSB</sub>	—		1.30	1.45	1.60		
OSD contrast adjustment characteristic	V <sub>UOSDR11</sub>	—	(Note T30)	0.58	0.64	0.71	Vp-p	
	V <sub>UOSDG11</sub>	—		0.58	0.64	0.71		
	V <sub>UOSDB11</sub>	—		0.58	0.64	0.71		
	V <sub>UOSDR10</sub>	—		0.47	0.53	0.59		
	V <sub>UOSDG10</sub>	—		0.47	0.53	0.59		
	V <sub>UOSDB10</sub>	—		0.47	0.53	0.59		
	V <sub>UOSDR01</sub>	—		0.31	0.37	0.45		
	V <sub>UOSDG01</sub>	—		0.31	0.37	0.45		
	V <sub>UOSDB01</sub>	—		0.31	0.37	0.45		
	V <sub>UOSDR00</sub>	—		0.19	0.22	0.24		
	V <sub>UOSDG00</sub>	—		0.19	0.22	0.24		
	V <sub>UOSDB00</sub>	—		0.19	0.22	0.24		
Analog OSD bright adjustment characteristic	V <sub>brOSD0</sub>	—	(Note T31)	2.20	2.40	2.60	V	
	V <sub>brOSD1</sub>	—		2.05	2.25	2.45		
	V <sub>brOSD2</sub>	—		1.95	2.15	2.35		
	V <sub>brOSD3</sub>	—		1.80	2.00	2.20		
Analog OSD mode switching voltage	V <sub>OSDON1</sub>	—	Pin 80	2.05	2.30	2.55	V	
	V <sub>OSDON2</sub>	—	Pin 1	2.05	2.30	2.55		
Analog OSD mode switching transfer characteristic	τ <sub>RY1</sub>	—	(Note T32)	—	15	50	ns	
	t <sub>PRYS1</sub>	—		—	20	50		
	Δt <sub>PRYS1</sub>	—		—	0	10		
	τ <sub>FYS1</sub>	—		—	10	50		
	t <sub>PRYS1</sub>	—		—	—	30		50
	Δt <sub>PRYS1</sub>	—		—	—	0		10
	τ <sub>RY2</sub>	—		—	—	15		50
	t <sub>PRYS2</sub>	—		—	—	20		50
	Δt <sub>PRYS2</sub>	—		—	—	0		10
	τ <sub>FYS2</sub>	—		—	—	10		50
	t <sub>PRYS2</sub>	—		—	—	30		50
	Δt <sub>PRYS2</sub>	—		—	—	0		10
OSD ACL characteristic	OSDACL <sub>1</sub>	—	(Note T33)	—	0.00	—	dB	
	OSDACL <sub>2</sub>	—		—	0.00	—		
	OSDACL <sub>3</sub>	—		-6.7	-4.7	-2.7		
	OSDACL <sub>4</sub>	—		-16.5	-14.5	-12.5		

Characteristics		Symbol	Test Circuit	Test Condition	Min	Typ.	Max	Unit	
OSD blending characteristic		$\alpha 41TV_1$	—	(Note T34)	-7	-6	-5	dB	
		$\alpha 42TV_1$	—		-7	-6	-5		
		$\alpha 43TV_1$	—		-7	-6	-5		
		$\alpha 41TV_2$	—		-4	-3	-2		
		$\alpha 42TV_2$	—		-4	-3	-2		
		$\alpha 43TV_2$	—		-4	-3	-2		
		$\alpha 41TV_3$	—		—	-55	-50		
		$\alpha 42TV_3$	—		—	-55	-50		
		$\alpha 43TV_3$	—		—	-55	-50		
		$\alpha 41OSD_1$	—		-6.5	-5.5	-4.5		
		$\alpha 42OSD_1$	—		-6.5	-5.5	-4.5		
		$\alpha 43OSD_1$	—		-6.5	-5.5	-4.5		
		$\alpha 41OSD_2$	—		-12.0	-10.5	-9.0		
		$\alpha 42OSD_2$	—		-12.0	-10.5	-9.0		
		$\alpha 43OSD_2$	—		-12.0	-10.5	-9.0		
		$\alpha 41OSD_3$	—		—	-40	-30		
	$\alpha 42OSD_3$	—	—	-40	-30				
	$\alpha 43OSD_3$	—	—	-40	-30				
Input crosstalk	Y → RGB input	$V_V \rightarrow A$	—	Input: Signal 1 ( $f_o = 4$ MHz, Amplitude 0.7 Vp-p)	—	-50	-45	dB	
	Y → OSD input	$V_V \rightarrow O$	—		—	-55	-45		
	RGB input → Y	$V_A \rightarrow V$	—		—	-50	-45		
	RGB input → OSD input	$V_A \rightarrow O$	—		—	-50	-45		
	OSD input → Y	$V_O \rightarrow V$	—		—	-45	-40		
	OSD input → RGB input	$V_O \rightarrow A$	—		—	-50	-45		
	RGB input in three axes	—	—		Input: Signal 1 ( $f_o = 1$ MHz, Amplitude 0.7 Vp-p)	—	-50		-40
	OSD input in three axes	—	—			—	-50		-40
Blue stretch point/gain		$BLP_{min}$	—	(Note T35)	23	28	33	IRE	
		$BLP_{max}$	—		55	60	65		
		$BLG_{min}$	—		2.4	2.9	3.4	dB	
		$BLG_{max}$	—		5.4	6.4	7.4		
Blue stretch $\gamma$ correction		$BL\gamma_1$	—	(Note T36)	84	89	94	IRE	
		$BL\gamma_2$	—		89	94	99		
		$BL\gamma_3$	—		93	98	103		
		$BL\gamma_4$	—		98	103	108		
White letters improvement		WPL1	—	(Note T37)	16	21	25	Vp-p	
		WPL2	—		51	56	61		
		WPL3	—		97	102	107		

## Sync Block

Characteristics	Symbol	Test Circuit	Test Condition	Min	Typ.	Max	Unit
Sync input horizontal sync phase	S <sub>PH</sub>	—	(Note HA01)	0.55	0.65	0.75	μs
HD input horizontal sync phase	HDPH	—	(Note HA02)	0.58	0.68	0.78	μs
Polarity detecting rage	HD <sub>DUTY1</sub>	—	(Note HA03)	—	0.5	2.0	%
	HD <sub>DUTY2</sub>	—		62	67	72	
	HD <sub>DUTY3</sub>	—		—	99.5	98	
	HD <sub>DUTY4</sub>	—		47.5	52.5	57.5	
Sync input threshold amplitude	V <sub>thS00</sub>	—	(Note HA04)	10	16	22	%
	V <sub>thS01</sub>	—		18	24	30	
	V <sub>thS10</sub>	—		26	32	38	
	V <sub>thS11</sub>	—		34	40	46	
HD input threshold voltage	V <sub>thHD</sub>	—	(Note HA05)	0.65	0.75	0.85	V <sub>p-p</sub>
Horizontal picture position (phase) adjustment variable range	ΔH <sub>SFT-</sub>	—	(Note HA06)	11	12.5	14	%
	ΔH <sub>SFT+</sub>	—		11	12.5	14	
Horizontal picture position (phase) shift switching amount	H <sub>SFT</sub>	—	—	5.2	6.7	9.2	%
Curve correction variable amount	ΔH <sub>#40</sub>	—	(Note HA07)	2.9	3.4	3.9	%
Clamp pulse phase/width/level	CP <sub>S0</sub>	—	(Note HA08)	3.1	3.8	4.5	%
	CP <sub>W0</sub>	—		2.0	2.5	3.0	
	CP <sub>V0</sub>	—		4.7	5.0	5.3	V
	CP <sub>S1</sub>	—		0	0.7	1.5	%
	CP <sub>W1</sub>	—		1.9	2.4	2.9	
	CP <sub>V1</sub>	—		4.7	5.0	5.3	V
	CP <sub>S2</sub>	—		3.2	4.2	5.2	%
	CP <sub>W2</sub>	—		2.2	2.7	3.2	
CP <sub>V2</sub>	—	4.7	5.0	5.3	V		
Black peak detection pulse phase	HBP <sub>S00a</sub>	—	(Note HA09)	1.2	3.0	5.9	%
	HBP <sub>S00b</sub>	—		1.2	3.0	5.9	
	HBP <sub>S01a</sub>	—		6.0	8.0	11.0	
	HBP <sub>S01b</sub>	—		6.0	8.0	11.0	
	HBP <sub>s10a</sub>	—		10.0	13.0	15.0	
	HBP <sub>s10b</sub>	—		10.0	13.0	15.0	
	HBP <sub>s11a</sub>	—		16.0	18.0	21.0	
	HBP <sub>s11b</sub>	—		16.0	18.0	21.0	
FBP threshold	V <sub>thFBP</sub>	—	(Note HA10)	4.8	5.3	5.8	V
HVCO oscillation start voltage	V <sub>VCO</sub>	—	Pin 42: Monitor, V <sub>CC</sub> voltage	3.0	4.0	5.0	V
H-OUT start voltage	V <sub>HON</sub>	—	Pin 37: Monitor, V <sub>CC</sub> voltage	5.0	6.0	7.0	V
H-OUT stop voltage	V <sub>HOFF</sub>	—	Pin 37: Monitor, V <sub>CC</sub> voltage	4.3	5.3	6.3	V
H-OUT pulse duty	TH <sub>A</sub>	—	(Note HB01)	38	41	43	%
	TH <sub>B</sub>	—		44	47	49	



Characteristics		Symbol	Test Circuit	Test Condition	Min	Typ.	Max	Unit
Horizontal free-run frequency		F15K	—	(Note HB02)	15.59	15.75	15.91	kHz
		F28K	—		27.90	28.125	28.35	
		F31K	—		31.19	31.5	31.82	
		F33K	—		33.41	33.75	34.09	
		F37K	—		37.60	37.9	38.40	
		F45K	—		44.52	45.0	45.48	
Horizontal oscillation frequency variable range		F15K <sub>MIN</sub>	—	(Note HB03)	14.78	15.08	15.38	kHz
		F15K <sub>MAX</sub>	—		16.37	16.70	17.03	
		F28K <sub>MIN</sub>	—		26.00	26.90	27.80	
		F28K <sub>MAX</sub>	—		28.90	29.70	30.60	
		F31K <sub>MIN</sub>	—		29.47	30.06	30.65	
		F31K <sub>MAX</sub>	—		32.72	33.39	34.06	
		F33K <sub>MIN</sub>	—		31.41	31.94	32.57	
		F33K <sub>MAX</sub>	—		34.91	35.62	36.33	
		F37K <sub>MIN</sub>	—		36.50	37.30	38.20	
		F37K <sub>MAX</sub>	—		40.20	41.10	42.10	
		F45K <sub>MIN</sub>	—		43.20	44.00	44.80	
		F45K <sub>MAX</sub>	—		47.85	48.65	49.45	
Horizontal oscillation control sensitivity		BH15K	—	Hz/0.1 V (Note HB04)	176	220	264	—
		BH28K	—		320	400	480	
		BH31K	—		352	440	528	
		BH33K	—		376	470	564	
		BH37K	—		390	480	570	
		BH45K	—		520	650	780	
H-OUT output voltage		V <sub>HOH</sub>	—	(Note HB05)	4.8	5.1	5.2	V
		V <sub>HOL</sub>	—		—	0.1	0.3	
Horizontal oscillation frequency control voltage threshold	Pin 55	V <sub>fHSW1</sub>	—	—	1.7	2.0	2.3	V
	Pin 41	V <sub>fHSW2L</sub>	—		1.3	1.5	1.7	
		V <sub>fHSW2M</sub>	—		4.3	4.5	4.7	
		V <sub>fHSW2H</sub>	—		7.3	7.5	7.7	
DAC switch voltage	DAC1	VDAC <sub>1H</sub>	—	TEST = (00), DAC1 = (0)	8.5	9.0	—	V
		VDAC <sub>1L</sub>	—	TEST = (00), DAC1 = (1)	—	0.3	0.7	
	DAC2	VDAC <sub>2H</sub>	—	TEST = (00), DAC2 = (1)	8.5	9.0	—	
		VDAC <sub>2L</sub>	—	TEST = (00), DAC2 = (0)	—	0.3	0.7	
VP output pulse width		VP <sub>W</sub>	—	(Note V01)	4	4.5	5	H
Vertical free-run (maximum pull-in range)	000	VPt0	—	—	1278	1281	1284	H
	001	VPt1	—		846	849	852	
	010	VPt2	—		722	725	728	
	011	VPt3	—		657	660	663	
	100	VPt4	—		610	613	616	
	101	VPt5	—		360	363	366	
	110	VPt6	—		304	307	310	
Vertical minimum pull-in range		T <sub>VPULL</sub>	—	(Note V02)	47	48	49	H

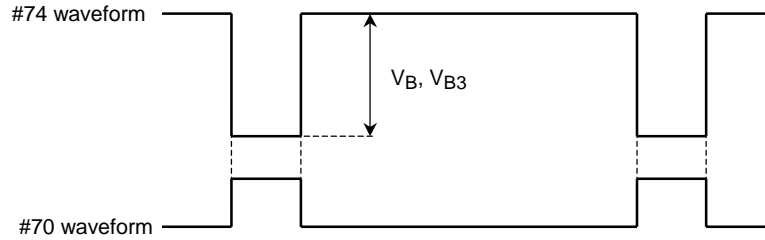
Characteristics		Symbol	Test Circuit	Test Condition	Min	Typ.	Max	Unit
Vertical black peak detection pulse	000	VBPP <sub>0E</sub>	—	(Note V03)	51	52	53	H
		VBPP <sub>0S</sub>	—		1099.5	1100.5	1101.5	
	001	VBPP <sub>1E</sub>	—		51	52	53	
		VBPP <sub>1S</sub>	—		729.5	730.5	731.5	
	010	VBPP <sub>2E</sub>	—		49.5	50.5	51.5	
		VBPP <sub>2S</sub>	—		599.5	600.5	601.5	
	011	VBPP <sub>3E</sub>	—		49.5	50.5	51.5	
		VBPP <sub>3S</sub>	—		544.5	545.5	546.5	
	100	VBPP <sub>4E</sub>	—		51	52	53	
		VBPP <sub>4S</sub>	—		499.5	500.5	501.5	
	101	VBPP <sub>5E</sub>	—		51	52	53	
		VBPP <sub>5S</sub>	—		289.5	290.5	291.5	
	110	VBPP <sub>6E</sub>	—		51	52	53	
		VBPP <sub>6S</sub>	—		239.5	240.5	241.5	
Vertical blanking end phase		V <sub>BLKMIN</sub>	—	(Note V04)	15	16	17	H
		V <sub>BLKMAX</sub>	—		45	46	47	
VP output voltage		High	V <sub>VPH</sub>	pin 35 voltage	4.6	5.0	5.4	V
		Low	V <sub>VPL</sub>		—	0.1	0.5	
SYNC input to VP output delay time		15.75 kHz	—	—	10.0	11.6	13.4	μs
		28.125 kHz	—		5.4	6.4	8.8	
		31.5 kHz	—		4.8	5.8	7.6	
		33.75 kHz	—		4.4	5.4	7.2	
		37.9 kHz	—		3.9	4.8	6.6	
		45 kHz	—		3.1	4.1	5.9	
Compression BLK 1 (start phase)		000	CBLK1 <sub>000min</sub>	—	1087	1088	1089	H
			CBLK1 <sub>000max</sub>	—	1117	1118	1119	
		001	CBLK1 <sub>001min</sub>	—	719	720	721	
			CBLK1 <sub>001max</sub>	—	749	750	751	
		010	CBLK1 <sub>010min</sub>	—	591	592	593	
			CBLK1 <sub>010max</sub>	—	621	622	623	
		011	CBLK1 <sub>011min</sub>	—	527	528	529	
			CBLK1 <sub>011max</sub>	—	557	558	559	
		100	CBLK1 <sub>100min</sub>	—	487	488	489	
			CBLK1 <sub>100max</sub>	—	517	518	519	
		101	CBLK1 <sub>101min</sub>	—	279	280	281	
			CBLK1 <sub>101max</sub>	—	309	310	311	
		110	CBLK1 <sub>110min</sub>	—	223	224	225	
			CBLK1 <sub>110max</sub>	—	253	254	255	

Characteristics		Symbol	Test Circuit	Test Condition	Min	Typ.	Max	Unit
Compression BLK 2 (end phase)	000	CBLK2 <sub>000</sub> min	—	—	49	50	51	H
		CBLK2 <sub>000</sub> max	—		77	78	79	
	001	CBLK2 <sub>001</sub> min	—		49	50	51	
		CBLK2 <sub>001</sub> max	—		77	78	79	
	010	CBLK2 <sub>010</sub> min	—		49	50	51	
		CBLK2 <sub>010</sub> max	—		77	78	79	
	011	CBLK2 <sub>011</sub> min	—		49	50	51	
		CBLK2 <sub>011</sub> max	—		77	78	79	
	100	CBLK2 <sub>100</sub> min	—		49	50	51	
		CBLK2 <sub>100</sub> max	—		77	78	79	
	101	CBLK2 <sub>101</sub> min	—		49	50	51	
		CBLK2 <sub>101</sub> max	—		77	78	79	
	110	CBLK2 <sub>110</sub> min	—		49	50	51	
		CBLK2 <sub>110</sub> max	—		77	78	79	
External V-BLK input current	I <sub>EXTBLK</sub>	—	Pin 35 input current	520	625	780	μA	

## Test Condition for Picture Quality (Sharpness) Block

### Common Test Condition for Picture Quality (Sharpness) Block

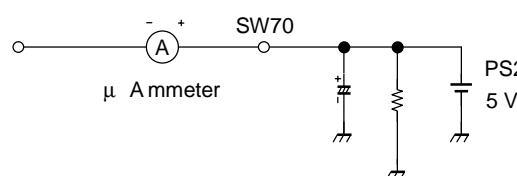
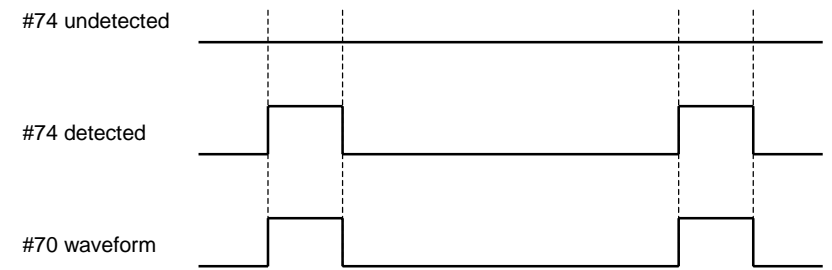
1. SW67 = SW66 = B, SW63 = B, SW60 to SW61 = B, SW44 = ON, SW40 = B, SW18 to SW26 = A, SW77 = OPEN
2. Send bus control data as preset values, turn ACB operation switching to ACB OFF (00), select Sync input (1), turn P-MODE to Normal 1(000), WPL-LEVEL to max (111), and change subaddress (1C) to (03).
3. Input sync signal, which is in sync with input signal for testing except "Sweep", to #53 (Sync input). "H-Freq." should be the same frequency as the one of #53.
4. Set Y/color difference input mode to (0), sync separator level to 20 % (01), and vertical free-running frequency to 307H (110).

Note No.	Characteristics	Test Conditions					Test Method (Test condition: $V_{CC} = 9 V/2$ , $T_a = 25 \pm 3^\circ C$ )
		SW Mode					
		SW71	SW70	SW68	SW64	SW74	
P01	Black detection level shift	B	C	C	B	OPEN	<ol style="list-style-type: none"> <li>1. Connect external power supply PS to #68, and monitor #70 and #74.</li> <li>2. Set black stretch point 1 to OFF (000), and black detection level to 0 IRE (1).</li> <li>3. Increase PS voltage from 4.95 V in steps of 1 mV. At the moment when #70 picture period (High) drops to Low level, monitor DC difference on #74 <math>V_B</math>.</li> <li>4. Set black detection level to 3 IRE (0).</li> <li>5. Repeat the step 3 above and monitor DC difference, <math>V_{B3}</math> on #74.</li> </ol> 
P02	Black stretch amp maximum gain	B	A	A	B	OPEN	<ol style="list-style-type: none"> <li>1. Set SW70 to A (maximum gain), and input 500-kHz sine wave to TPA.</li> <li>2. Adjust signal amplitude to 0.1 Vp-p on #68.</li> <li>3. Set black stretch point 1 to OFF (000), and measure #74 amplitude <math>V_A</math>.</li> <li>4. Set black stretch point 1 to 001 (black stretch ON), and measure #74 amplitude <math>V_B</math>.</li> <li>5. Calculate GBS using a following equation.  <math display="block">GBS = 20 \times \log (V_B + V_A) \text{ [dB]}</math> </li> </ol>

Note No.	Characteristics	Test Conditions					Test Method (Test condition: $V_{CC} = 9\text{ V}/2\text{ V}$ , $T_a = 25 \pm 3^\circ\text{C}$ )
		SW Mode					
		SW71	SW70	SW68	SW64	SW74	
P03	Black stretch start point 1	A	A	C	B	OPEN	<ol style="list-style-type: none"> <li>Set SW70 to A (maximum gain), and black stretch point 1 to OFF (000). Apply 0 V to #71.</li> <li>Connect external power supply PS to #68, increase voltage from <math>V_3</math>, and plot #74 voltage change S1. The #74 voltage is set as <math>V_0</math> when <math>V_3</math> is applied, and as <math>V_{100}</math> when <math>V_3 + 0.7\text{ V}</math> is applied.</li> <li>Set black stretch point 1 to minimum (001), increase PS voltage from <math>V_3</math>, and then plot #74 voltage change S2.</li> <li>Set black stretch point to maximum (111), repeat 3 above, then plot #74 voltage change S3.</li> <li>Determine intersection points of S1, S2 (<math>V_{BST1}</math>), and S3 (<math>V_{BST2}</math>) as shown in the figure below. Also calculate <math>P_{BST1}</math> and <math>P_{BST2}</math> using following equations.  <math display="block">V_Z [V] = V_{100} [V] - V_0 [V]</math> <math display="block">P_{BST1} [(IRE)] = [(V_{BST1} [V] - V_{74} [V]) + V_Z] \times 100 (IRE)</math> <math display="block">P_{BST2} [(IRE)] = [(V_{BST2} [V] - V_{74} [V]) + V_Z] \times 100 (IRE)</math> </li> </ol>

Note No.	Characteristics	Test Conditions					Test Method (Test condition: $V_{CC} = 9 V/2 V$ , $T_a = 25 \pm 3^\circ C$ )
		SW Mode					
		SW71	SW70	SW68	SW64	SW74	
P04	Black stretch start point 2	A	A	A	B	ON	<ol style="list-style-type: none"> <li>Set black stretch point 1 to OFF (000), apply 0 V to #71, input TG7 LINEARITY to TPA, adjust amplitude on #68 as shown in the figure below, set unicolor to center (1000000), and measure amplitude of #12 (R OUT), <math>V_{P12}</math>.</li> <li>Set black stretch point 1 to 001 (black stretch ON), connect external power supply PS to #74, and monitor #12 (R OUT).</li> <li>Set black stretch start point 2 data to minimum (00). When PS is <math>V_{74}</math> (APL 0%), and <math>V_{74} + 1.0 V</math> (APL 100%), determine black stretch start point difference <math>\Delta V_{00}</math> as shown in the figure below. (Monitor input waveform and output waveform with an oscilloscope, adjust the both waveforms to have the same amplitude (gradient), and compare them to determine the bend point of the output.)</li> <li>Set black stretch start point 2 data to maximum (11), determine black stretch start point difference <math>\Delta V_{11}</math>.</li> <li>Calculate following equations.  <math display="block">P_{BS1} = (\Delta V_{00} / V_{P12}) \times 100</math> <math display="block">P_{BS2} = (\Delta V_{11} / V_{P12}) \times 100</math> </li> </ol>

Note No.	Characteristics	Test Conditions					Test Method (Test condition: $V_{CC} = 9 V/2 V$ , $T_a = 25 \pm 3^\circ C$ )
		SW Mode					
		SW71	SW70	SW68	SW64	SW74	
P05	Black stretch characteristic switch	A	A	C	B	OPEN	<ol style="list-style-type: none"> <li>Set SW70 to A (maximum gain), black stretch point 1 (18) to maximum (E0), subaddress (1C) data to (00) and (1E) data to (08).</li> <li>Apply 0 V to #71 and connect external power supply PS to #68. Set PS to <math>V_{68} + 0.7 V</math>, and adjust unicolor so that DC level of #12 is +1.0 V. Plot voltage change S4 of #12 (voltage in picture period).</li> <li>Determine intersection points (<math>V_{BSC1}</math> and <math>V_{BSC2}</math>) of S2 and S4 obtained from the plot in black stretch start point 1. Then calculate <math>P_{BSC1}</math> and <math>P_{BSC2}</math> using following equation.</li> <li>Set black stretch characteristic switch subaddress data (1C)/(1E) to (20)/(00) and (20)/(08) respectively. As described in steps 2 and 3, determine intersection points (<math>V_{BSC3}</math>, <math>V_{BSC4}</math>, <math>V_{BSC5}</math> and <math>V_{BSC6}</math>) and calculate <math>P_{BSC3}</math>, <math>P_{BSC4}</math>, <math>P_{BSC5}</math> and <math>P_{BSC6}</math>.</li> </ol> $P_{BSC*} = (V_{BSC*} [V] - V_{12} [V]) \div 1.0 \times 100 \quad [(IRE)]$

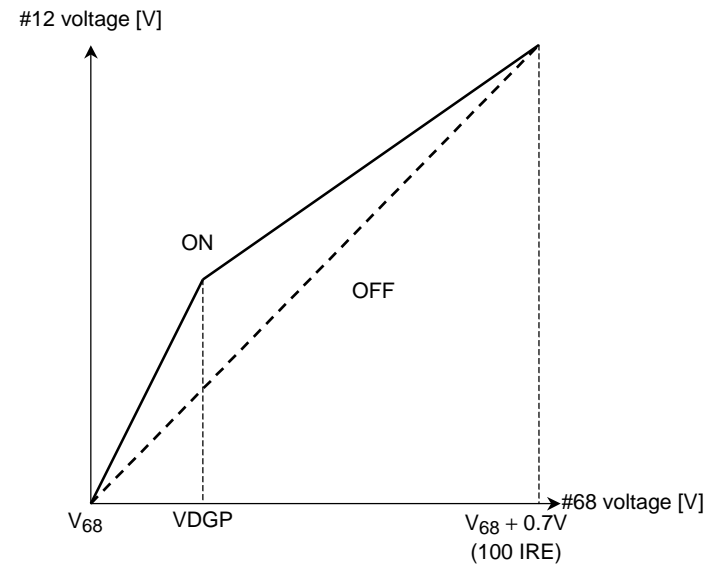
Note No.	Characteristics	Test Conditions					Test Method (Test condition: $V_{CC} = 9\text{ V}/2\text{ V}$ , $T_a = 25 \pm 3^\circ\text{C}$ )
		SW Mode					
		SW71	SW70	SW68	SW64	SW74	
P06	Black stretch area reinforcement current	B	—	C	B	ON	<ol style="list-style-type: none"> <li>1. Connect external power supply PS1 to #68.</li> <li>2. Leave SW70 open, put an ammeter between SW70A and #70, connect external power supply PS2 to SW70A, set PS1 to 5.7 V, and set PS2 to 5 V.</li> <li>3. Measure current value IBSA0 and IBSA1 when bus data of black stretch area reinforcement [18] is set to ON [80] and OFF [81]. Calculate IBSA using the following equation. <math display="block">\text{IBSA} = \text{IBSA0} - \text{IBSA1}</math></li> </ol> 
P07	D.ABL detection voltage	B	A	C	B	OPEN	<ol style="list-style-type: none"> <li>1. Set D.ABL sensitivity to maximum (11), and black stretch point 1 to OFF (000).</li> <li>2. Connect external power supply PS to #78 and decrease voltage from 6.5 V.</li> <li>3. Repeat 2 when D.ABL detection voltage is changed to 00, 01, 10, and 11. At the moment when #74 picture period changes to Low, measure respective PS voltages <math>V_{00}</math>, <math>V_{01}</math>, <math>V_{10}</math>, and <math>V_{11}</math>.</li> <li>4. Calculate voltage differences between <math>V_{00}</math> and <math>V_{01}</math> (<math>DV_{01}</math>), between <math>V_{00}</math> and <math>V_{10}</math> (<math>DV_{10}</math>), and between <math>V_{00}</math> and <math>V_{11}</math> (<math>DV_{11}</math>) <math display="block">DV_{***} = V_{00} - V_{01} (V_{10}, V_{11})</math></li> </ol> 



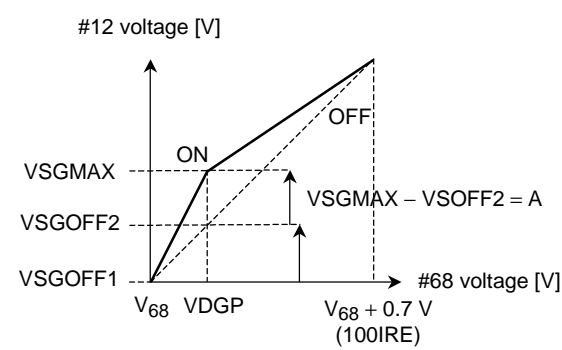
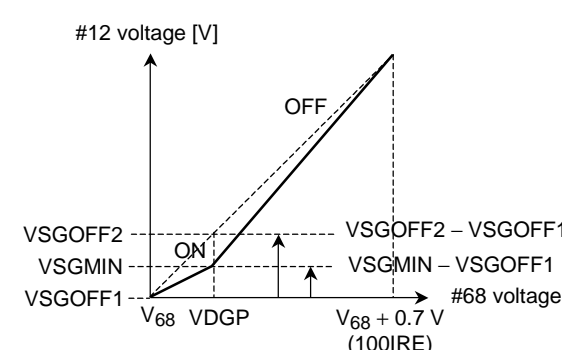
Note No.	Characteristics	Test Conditions					Test Method (Test condition: $V_{CC} = 9 V/2 V$ , $T_a = 25 \pm 3^\circ C$ )
		SW Mode					
		SW71	SW70	SW68	SW64	SW74	
P08	D.ABL sensitivity	B	A	C	B	ON	<ol style="list-style-type: none"> <li>Set black stretch point 1 to OFF (00), and connect external power supply to #78.</li> <li>Set D.ABL detection voltage to minimum (00). Interrelation between #78 voltage and #74 voltage when D.ABL sensitivity is set to minimum (00) and maximum (11) can be plotted as figure shown below.</li> <li>Measure gradients SDAMIN and SDAMAX using the figure below.  <math>SDAMIN = \Delta Y/\Delta X</math>    <math>SDAMAX = \Delta Y/\Delta X</math> </li> </ol>

Note No.	Characteristics	Test Conditions					Test Method (Test condition: $V_{CC} = 9\text{ V}/2\text{ V}$ , $T_a = 25 \pm 3^\circ\text{C}$ )
		SW Mode					
		SW71	SW70	SW68	SW64	SW74	
P09	Black level correction	B	A	A	B	OPEN	<ol style="list-style-type: none"> <li>Set black stretch point 1[18] to OFF (00).</li> <li>Input signal of 0.7-V picture period amplitude to #68, and measure #12 picture period amplitude <math>V_B</math> [V].</li> <li>Set black level correction [18] to ON [04], determine DC change <math>V_{BLC}</math> [V], and calculate BLC [V] using the following equation  <math display="block">BLC = (V_{BLC}/V_B) \times 100 \text{ [(IRE)]}</math> </li> </ol>

Note No.	Characteristics	Test Conditions					Test Method (Test condition: $V_{CC} = 9 V/2 V$ , $T_a = 25 \pm 3^\circ C$ )
		SW Mode					
		SW71	SW70	SW68	SW64	SW74	
P10	Dynamic $Y\gamma$ correction point	A	B	C	B	OPEN	<ol style="list-style-type: none"> <li>1. Connect external power supply PS1 to #68, PS2 to TP1, and set PS2 to 0 V.</li> <li>2. Set dark area dynamic <math>Y\gamma</math> gain VS dark area to MIN (00), static <math>Y\gamma</math> gain1 to OFF (000).</li> <li>3. Increase PS1 from <math>V_{68}</math> [V] to <math>V_{68}</math> [V] + 0.7 V and plot voltage change of #12 picture period. Take 0 for <math>V_{68}</math> [V] when the change is plotted. (<math>V_{68}</math> is pin voltage of pin 68)</li> <li>4. Set dark area dynamic <math>Y\gamma</math> gain VS dark area max (11), static <math>Y\gamma</math> gain1 to max (111) and PS2 to 1.2 V.</li> <li>5. Increase PS1 from <math>V_{68}</math> [V] to <math>V_{68}</math> [V] + 0.7 V and plot voltage change of #12 picture period.</li> <li>6. Measure VDGP by the following figure, and <math>P_{DGP}</math> using the following equation.  <math display="block">DGP = (VDGP [V] - V_{68} [V])/0.7 [V] \times 100</math> </li> </ol>

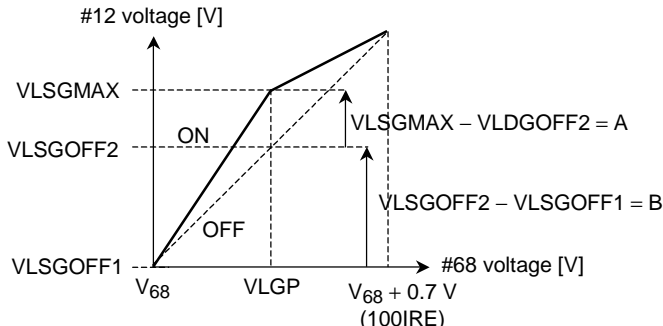
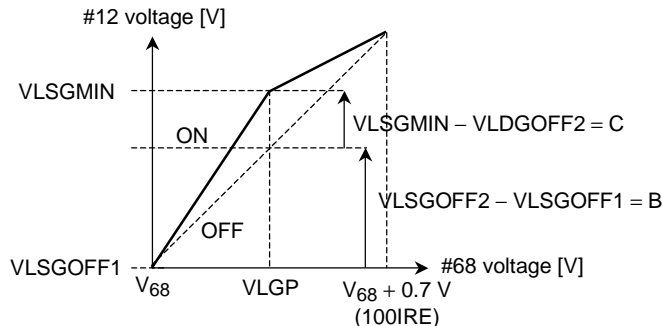


Note No.	Characteristics	Test Conditions					Test Method (Test condition: $V_{CC} = 9\text{ V}/2\text{ V}$ , $T_a = 25 \pm 3^\circ\text{C}$ )
		SW Mode					
		SW71	SW70	SW68	SW64	SW74	
P11	Dark area dynamic $Y\gamma$ gain	A	B	C	B	OPEN	<ol style="list-style-type: none"> <li>1. Connect external power supply PS1 to #68, external power supply PS2 to TP1, and set PS2 to 0 V.</li> <li>2. Set dark area dynamic <math>Y\gamma</math> gain [1C] to MIN [03], and dark area static <math>Y\gamma</math> gain [1C] to 0dB [17].</li> <li>3. Set PS1 to <math>V_{68}</math> [V], and measure #12 picture period voltage <math>V_{DDGV_{68}}</math> [V]. Set PS1 VDGP [V], and measure #12 picture period voltage <math>V_{DDGMIN}</math> [V].</li> <li>4. Set dark area dynamic <math>Y\gamma</math> gain [1C] to MAX [D7], PS2 to 1.2 V, measure voltage <math>V_{DDGMAX}</math> [V] of #12 picture period when PS1 is VDGP [V], and calculate the following equations.                             <math display="block">V_{DDGMAX} - V_{DDGMIN} = A</math> <math display="block">V_{DDGMIN} - V_{DDGV_{68}} = B</math> <math display="block">G_{DDGMAX} = 20 \log [B/(B-A)] \text{ [dB]}</math> </li> </ol>

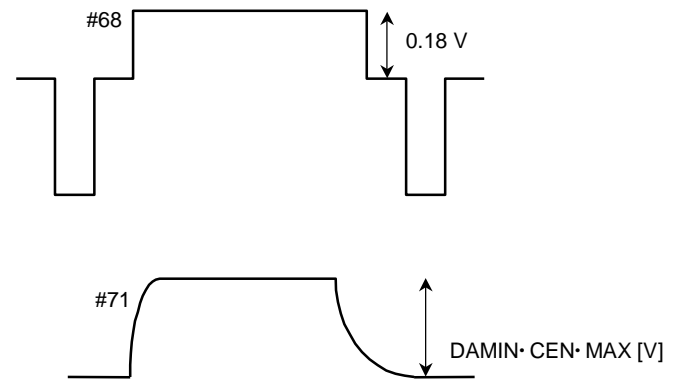
Note No.	Characteristics	Test Conditions					Test Method (Test condition: $V_{CC} = 9\text{ V}/2\text{ V}$ , $T_a = 25 \pm 3^\circ\text{C}$ )
		SW Mode					
		SW71	SW70	SW68	SW64	SW74	
P12	Dark area static $Y\gamma$ gain	A	B	C	B	OPEN	<ol style="list-style-type: none"> <li>Connect external power supply PS1 to #68, external power supply PS2 to TP1, and set PS2 to 0 V.</li> <li>Set dark area dynamic <math>Y\gamma</math> gain [1C] to MIN [03], and dark area static <math>Y\gamma</math> gain [1C] to OFF [03].</li> <li>Set PS1 to <math>V_{68}</math> [V], and measure #12 picture period voltage VSGOFF1 [V].</li> <li>Set PS1 to VDGP [V], and measure #12 picture period voltage VSGOFF2 [V].</li> <li>Set dark area static <math>Y\gamma</math> gain [1C] to MAX [1F], PS1 to VDGP [V], measure #12 picture period voltage VSGMAX, and calculate GDSGMAX using the following equations.                             <math display="block">\text{VSGMAX} - \text{VSGOFF2} = A</math> <math display="block">\text{VSGOFF2} - \text{VSGOFF1} = B</math> <math display="block">\text{GDSGMAX} = 20 \times \log [B/(B - A)] \text{ [dB]}</math>  </li> <li>Set dark area static <math>Y\gamma</math> gain [1C] to MIN [07], PS1 to VDGP [V], measure #12 picture period voltage VSGMIN, and calculate GDSGMIN using the following equation.                             <math display="block">\text{GDSGMIN} = 20 \times \log [(\text{VSGMIN} - \text{VSGOFF1})/(\text{VSGOFF2} - \text{VSGOFF1})] \text{ [dB]}</math>  </li> </ol>

Note No.	Characteristics	Test Conditions					Test Method (Test condition: $V_{CC} = 9 V/2 V$ , $T_a = 25 \pm 3^\circ C$ )
		SW Mode					
		SW71	SW70	SW68	SW64	SW74	
P13	Light area $Y\gamma$ correction point	A	B	C	A	OPEN	<ol style="list-style-type: none"> <li>1. Connect external power supply PS1 to #68, external power supply PS2 to TP1, and set PS2 to 0 V.</li> <li>2. Set dark area static <math>Y\gamma</math> gain [1C] to 0dB [17], and bright area static <math>Y\gamma</math> gain [1C] to 0dB [17].</li> <li>3. Increase PS1 from <math>V_{68}</math> [V] to <math>V_{68}</math> [V] + 0.7 [V], and plot the voltage change of #12 picture period. Take 0 for <math>V_{68}</math> [V] when the change is plotted. (<math>V_{68}</math> is pin voltage of pin 68)</li> <li>4. Set light area static <math>Y\gamma</math> gain [1C] to MAX [04].</li> <li>5. Increase PS1 from <math>V_{68}</math> [V] to <math>V_{68}</math> [V] + 0.7 [V], and plot the voltage change of #12 picture period.</li> <li>6. Measure VLGP using the following figure, and PLGP using the following equation.  <math display="block">LGP = (VLGP [V] - V_{68} [V]) / 0.7 [V] \times 100 \text{ (IRE)}</math> </li> </ol> <div style="text-align: center;"> </div>

Note No.	Characteristics	Test Conditions					Test Method (Test condition: $V_{CC} = 9\text{ V}/2\text{ V}$ , $T_a = 25 \pm 3^\circ\text{C}$ )
		SW Mode					
		SW71	SW70	SW68	SW64	SW74	
P14	Light area dynamic $Y_\gamma$ gain	A	B	C	A	OPEN	<ol style="list-style-type: none"> <li>1. Connect external power supply PS1 to #68, external power supply PS2 to TP7, and set PS2 to 1.2 V.</li> <li>2. Set dark area static <math>Y_\gamma</math> gain [1C] to 0dB [17], and light area static <math>Y_\gamma</math> gain [1C] to 0dB [17].</li> <li>3. Set PS1 to <math>V_{68}</math> [V], and measure #12 picture period voltage VLDGOFF1.</li> <li>4. Set PS1 to VLGP [V], and measure #12 picture period voltage VLDGOFF2.</li> <li>5. Set light area static <math>Y_\gamma</math> gain [1C] to MAX [14], PS2 to 0 V, PS1 to VLGP [V], determine #12 picture period voltage VLDGMAX [V] using the following equations.                             <math display="block">\text{VLDGMAX} - \text{VLDGOFF2} = A</math> <math display="block">\text{VLDGOFF2} - \text{VLDGOFF1} = B</math> <math display="block">\text{GLDG} = 20 \times \log [B/(B - A)]</math> </li> </ol>

Note No.	Characteristics	Test Conditions					Test Method (Test condition: $V_{CC} = 9 V/2 V$ , $T_a = 25 \pm 3^\circ C$ )
		SW Mode					
		SW71	SW70	SW68	SW64	SW74	
P15	Light area static $Y\gamma$ gain	B	B	C	A	OPEN	<ol style="list-style-type: none"> <li>Connect external power supply PS1 to #68, external power supply PS2 to TP7, and set PS2 to 0 V.</li> <li>Set dark area static <math>Y\gamma</math> gain [1C] to 0dB [17], and light area static <math>Y\gamma</math> gain [1C] to 0dB [17].</li> <li>Set PS1 to <math>V_{68}</math> [V], and measure #12 picture period voltage VLSGOFF1 [V].</li> <li>Set PS1 to VLGP [V], and measure #12 picture period voltage VLDGOFF2 [V].</li> <li>Set light area static <math>Y\gamma</math> gain [1C] to MAX [14], PS1 to VLGP [V], measure #12 picture period voltage VISGMAX, and calculate GLASGMAX [dB] using the following equations.  <math display="block">VLSGMAX - VLSGOFF2 = A</math> <math display="block">VLSGOFF2 - VLSGOFF1 = B</math> <math display="block">GLSGMAX = 20 \times \log [B/(B - A)] \text{ [dB]}</math>  </li> <li>Set light area static <math>Y\gamma</math> gain [1C] to MIN [16], PS1 to VLGP [V], measure #12 picture period voltage VLSGMIN, and calculate GLSGMIN [dB] using the following equations.  <math display="block">VLSGMIN - VLSGOFF2 = C</math> <math display="block">VLSGOFF2 - VLSGOFF1 = B</math> <math display="block">GLSGMIN = 20 \times \log [B/(B - C)] \text{ [dB]}</math>  </li> </ol>



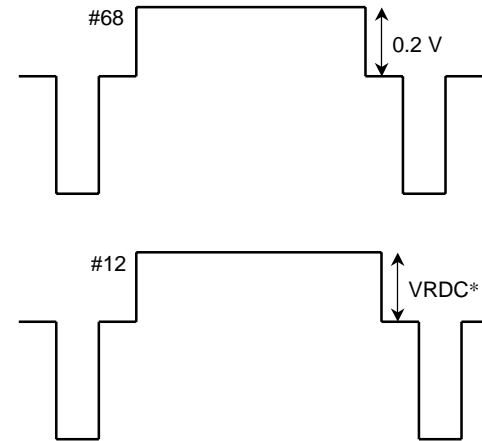
Note No.	Characteristics	Test Conditions					Test Method (Test condition: $V_{CC} = 9 V/2 V$ , $T_a = 25 \pm 3^\circ C$ )
		SW Mode					
		SW71	SW70	SW68	SW64	SW74	
P16	Dark area detection sensitivity	A	B	A	A	OPEN	<p>1. Input the signal whose picture period amplitude is 0.18 V to #68 as shown in the figure below.</p> <p>2. Measure #71 pin voltage DAMIN, DACEN, and DAMAX [V] when dark area detection sensitivity [1D] is set to MIN [00], CEN [04] and MAX [07].</p> 

Note No.	Characteristics	Test Conditions					Test Method (Test condition: $V_{CC} = 9 V/2 V$ , $T_a = 25 \pm 3^\circ C$ )
		SW Mode					
		SW71	SW70	SW68	SW64	SW74	
P17	DC restoration rate correction gain	B	B	C	B	ON	<ol style="list-style-type: none"> <li>Set DC restoration rate correction point to minimum (000), DC restoration rate correction limit point to 80% (11), and connect external power supply PS1 to #68.</li> <li>Monitor DC level of #12 picture period. Set PS1 to <math>V_{68} + 0.7 V</math>, and adjust uncolor so that DC level is + 0.7.</li> <li>Set DC restoration correction rate to minimum (000), and measure <math>V_{DT1}</math> and <math>V_{DT2}</math> of <math>V_{68}</math> [V] and <math>V_{68} + 0.1 V</math> as shown in the figure below.</li> <li>Set #68 to <math>V_{68} + 0.1 V</math>, DC restoration correction rate to maximum (111), and measure <math>V_{DT3}</math>.</li> <li>Set DC restoration correction rate SW to less than 100 % (1), #68 to <math>V_{68} + 0.1 V</math>, DC restoration correction rate to maximum (111), and measure <math>V_{DT4}</math>.</li> <li>Calculate <math>ADT_{100}</math>, <math>ADT_{135}</math>, and <math>ADT_{65}</math> using following equations.  <math display="block">ADT_{100} = (V_{DT2} [V] - V_{DT1} [V]) \div 0.1 [V]</math> <math display="block">ADT_{135} = (V_{DT3} [V] - V_{DT1} [V]) \div 0.1 [V]</math> <math display="block">ADT_{65} = 1 - ((V_{DT2} [V] - V_{DT4} [V]) \div 0.1 [V])</math> </li> </ol>

Note No.	Characteristics	Test Conditions					Test Method (Test condition: $V_{CC} = 9 V/2 V$ , $T_a = 25 \pm 3^\circ C$ )
		SW Mode					
		SW71	SW70	SW68	SW64	SW74	
P18	DC restoration rate correction point	B	B	C	B	ON	<ol style="list-style-type: none"> <li>Set DC restoration rate correction point to minimum (000), DC restoration rate correction limit point to 80% (11), and connect external power supply PS1 to #68.</li> <li>Monitor DC level of #12 picture period. Set PS1 to <math>V_{68} + 0.7 V</math>, and adjust unicolor so that DC level is + 1.0.</li> <li>Set DC restoration correction rate to minimum (000), and increase PS1 from <math>V_{68}</math>. Plot relation between #74 (DC voltage) and #12 (voltage in picture period).</li> <li>Set DC restoration correction rate to maximum (111), and increase PS1 from <math>V_{68}</math>. Plot relation between #74 and #12.</li> <li>Set DC restoration correction rate to maximum (111), DC restoration rate correction point (111), and increase PS1 from <math>V_{68}</math>. Plot relation between #74 and #12.</li> <li>Determine <math>V_{DT0}</math>, and <math>V_{DT1}</math> using the following equations.  <math display="block">V_{DT0} = [(V_{SP0} - V_{74})/1 V] \times 100\%</math> <math display="block">V_{DT1} = [(V_{SP1} - V_{74})/1 V] \times 100\%</math> </li> </ol>

Note No.	Characteristics	Test Conditions					Test Method (Test condition: $V_{CC} = 9 V/2 V$ , $T_a = 25 \pm 3^\circ C$ )
		SW Mode					
		SW71	SW70	SW68	SW64	SW74	
P19	DC restoration rate correction limit point	B	B	B	C	ON	<ol style="list-style-type: none"> <li>Set unicolor to maximum (1111111), DC restoration rate correction point to minimum (000), and connect external power supply PS1 to #74.</li> <li>Set DC restoration correction rate to maximum (111).</li> <li>Increase PS from 5 V. Monitor #12, and plot DC restoration correction amount.</li> <li>Repeat the step 3 above by changing data at DC restoration rate correction limit point. Measure the value using the figure below. Calculate <math>P_{DTL60}</math>, <math>P_{DTL75}</math>, <math>P_{DTL87}</math>, and <math>P_{DTL100}</math> using following equations.                             <math display="block">P_{DTL60} = [(V_{L60} - V_{74})/1.0] \times 100\%</math> <math display="block">P_{DTL75} = [(V_{L75} - V_{74})/1.0] \times 100\%</math> <math display="block">P_{DTL87} = [(V_{L87} - V_{74})/1.0] \times 100\%</math> <math display="block">P_{DTL100} = [(V_{L100} - V_{74})/1.0] \times 100\%</math> </li> </ol>

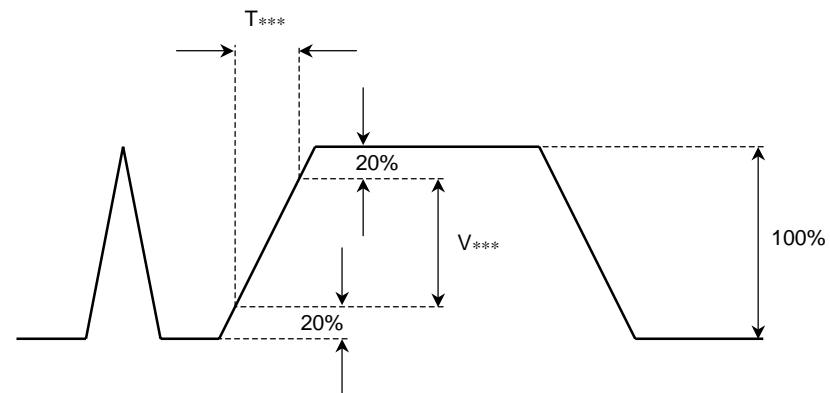
Note No.	Characteristics	Test Conditions					Test Method (Test condition: $V_{CC} = 9 V/2 V$ , $T_a = 25 \pm 3^\circ C$ )
		SW Mode					
		SW71	SW70	SW68	SW64	SW74	
P20	DC fluctuation at switching sharpness control peak frequency	B	B	A	B	ON	<ol style="list-style-type: none"> <li>Set unicolor [05] to MAX [7F], SRT gain [19] to MIN [00], and CDE [15] to CEN [80]. Input setup signal (0.2 Vp-p) to TPA as shown in the figure below.</li> <li>Set sharpness [09] to MIN [00] and MAX [80]. Monitor #43, measure DC level VRDCMIN and VRDCMAX [V]. Calculate VRDC [V] using the following equation.  <math display="block">VRDC = VRDCMIN - VRDCMAX \quad [V]</math> </li> </ol>



Note No.	Characteristics	Test Conditions					Test Method (Test condition: $V_{CC} = 9 V/2 V$ , $T_a = 25 \pm 3^\circ C$ )
		SW Mode					
		SW71	SW70	SW68	SW64	SW74	
P21	Sharpness control range	B	B	A	B	ON	<ol style="list-style-type: none"> <li>1. Input sine wave to TPA. (The frequency is variable.)</li> <li>2. Set #68 amplitude to 20 mVp-p.</li> <li>3. Set unicolor to maximum (1111111), SRT-GAIN to minimum (00000), APACON peak frequency to 13.5 M (00), and color detail enhancer (CDE) to center (10).</li> <li>4. Set picture mute to OFF (P-MODE: Normal 1, 000), and monitor #12.</li> <li>5. Set picture sharpness to center (1000000). Set input frequency to 100 kHz, and measure the amplitude <math>V_{100}</math>.</li> <li>6. Set picture sharpness to maximum (1111111). Set input frequency to <math>F_{AP00}</math>, measure the amplitude <math>V_{MAX00}</math>, and calculate <math>G_{MAX00}</math> using the following equations.</li> <li>7. Set picture sharpness to minimum (0000000). Set input frequency to <math>F_{AP00}</math>, measure the amplitude <math>V_{MIN00}</math>, and calculate <math>G_{MIN00}</math> using the following equations.</li> <li>8. Set APACON peak frequency to 9.5 M (01). Set input frequency to <math>F_{AP01}</math>, measure <math>V_{MAX01}/V_{MIN01}</math> and calculate <math>G_{MAX01}/G_{MIN01}</math>.</li> <li>9. Set APACON peak frequency to 6.4 M (10). Set input frequency to <math>F_{AP10}</math>, measure <math>V_{MAX10}/V_{MIN10}</math> and calculate <math>G_{MAX10}/G_{MIN10}</math>.</li> <li>10. Set APACON peak frequency to 4.5 M (11). Set input frequency to <math>F_{AP11}</math>, measure <math>V_{MAX11}/V_{MIN11}</math> and calculate <math>G_{MAX11}/G_{MIN11}</math>.                     <math display="block">G_{MAX***} = 20 \times \log (V_{MAX***} \div V_{100}) \text{ [dB]}</math> <math display="block">G_{MIN***} = 20 \times \log (V_{MIN***} \div V_{100}) \text{ [dB]}</math> </li> </ol> <p>Note: When a spectrum analyzer is used, measure gain for low frequency.</p>

Note No.	Characteristics	Test Conditions					Test Method (Test condition: $V_{CC} = 9 V/2 V$ , $T_a = 25 \pm 3^\circ C$ )
		SW Mode					
		SW71	SW70	SW68	SW64	SW74	
P22	Sharpness control center characteristic	B	B	A	B	ON	<ol style="list-style-type: none"> <li>1. Input sine wave to TPA. (The frequency is variable.)</li> <li>2. Set the amplitude of #68 to 20 mVp-p.</li> <li>3. Set unicolor to maximum (11111111), SRT-GAIN to minimum (00000), APACON peak frequency to 13.5 M (00), and color detail enhancer (CDE) to center (10).</li> <li>4. Set picture mute to OFF (P-MODE: Normal 1, 000), and monitor #12.</li> <li>5. Set picture sharpness to center (1000000). Set input frequency to 100 kHz, and measure the amplitude <math>V_{100}</math>.</li> <li>6. Set picture sharpness to center (1000000). Set input frequency to <math>F_{AP00}</math>, measure #12 amplitude <math>V_{CEN00}</math>, and calculate <math>G_{CEN00}</math> using the following equations.</li> <li>7. Set APACON peak frequency to 9.5 M (01). Set input frequency to <math>F_{AP01}</math>, measure <math>V_{CEN01}</math> and calculate <math>G_{CEN01}</math>.</li> <li>8. Set APACON peak frequency to 6.4 M (10). Set input frequency to <math>F_{AP10}</math>, measure <math>V_{CEN10}</math> and calculate <math>G_{CEN10}</math>.</li> <li>9. Set APACON peak frequency to 4.5 M (11). Set input frequency to <math>F_{AP11}</math>, measure <math>V_{CEN11}</math> and calculate <math>G_{CEN11}</math>.</li> </ol> $G_{CEN***} = 20 \times \log (V_{CEN***} \div V_{100}) \text{ [dB]}$ <p>Note: When a spectrum analyzer is used, measure gain for low frequency.</p>

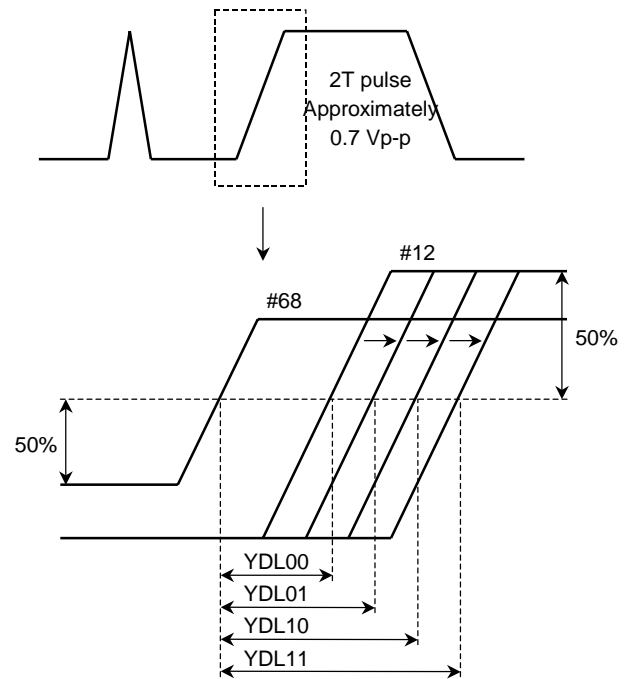
Note No.	Characteristics	Test Conditions					Test Method (Test condition: $V_{CC} = 9 V/2 V$ , $T_a = 25 \pm 3^\circ C$ )
		SW Mode					
		SW71	SW70	SW68	SW64	SW74	
P23	2T pulse response SRT control	B	B	A	B	ON	<ol style="list-style-type: none"> <li>1. Input 2T pulse (0.7 Vp-p) signal to TPA. Set unicolor to maximum (1111111), SRT-GAIN to minimum (00000), CDE to center (10) picture sharpness control to center (1000000).</li> <li>2. Set APACON peak frequency to 13.5 M (00), and monitor #12.</li> <li>3. Measure <math>T_{SRTMIN00}</math> and <math>V_{SRTMIN00}</math> as shown in the figure below.</li> <li>4. Set SRT-GAIN to maximum (11111), and measure <math>T_{SRTMAX00}</math> and <math>V_{SRTMAX00}</math>.</li> <li>5. Set APACON peak frequency to 9.5 M (01). Set SRT-GAIN to minimum (00000) and maximum (11111). Measure <math>T_{SRTMIN01}/V_{SRTMIN01}</math> and <math>T_{SRTMAX01}/V_{SRTMAX01}</math>.</li> <li>6. Set APACON peak frequency to 6.4 M (10). Set SRT-GAIN to minimum (00000) and maximum (11111). Measure <math>T_{SRTMIN10}/V_{SRTMIN10}</math> and <math>T_{SRTMAX10}/V_{SRTMAX10}</math>.</li> <li>7. Set APACON peak frequency to 4.5 M (11). Set SRT-GAIN to minimum (00000) and maximum (11111). Measure <math>T_{SRTMIN11}/V_{SRTMIN11}</math> and <math>T_{SRTMAX11}/V_{SRTMAX11}</math>.</li> <li>8. Calculate the following equations.                     <math display="block">T_{SRT00} = 20 \times \log [(V_{SRTMAX00}/T_{SRTMAX00})/(V_{SRTMIN00}/T_{SRTMIN00})]</math> <math display="block">T_{SRT01} = 20 \times \log [(V_{SRTMAX01}/T_{SRTMAX01})/(V_{SRTMIN01}/T_{SRTMIN01})]</math> <math display="block">T_{SRT10} = 20 \times \log [(V_{SRTMAX10}/T_{SRTMAX10})/(V_{SRTMIN10}/T_{SRTMIN10})]</math> <math display="block">T_{SRT11} = 20 \times \log [(V_{SRTMAX11}/T_{SRTMAX11})/(V_{SRTMIN11}/T_{SRTMIN11})]</math> </li> </ol>



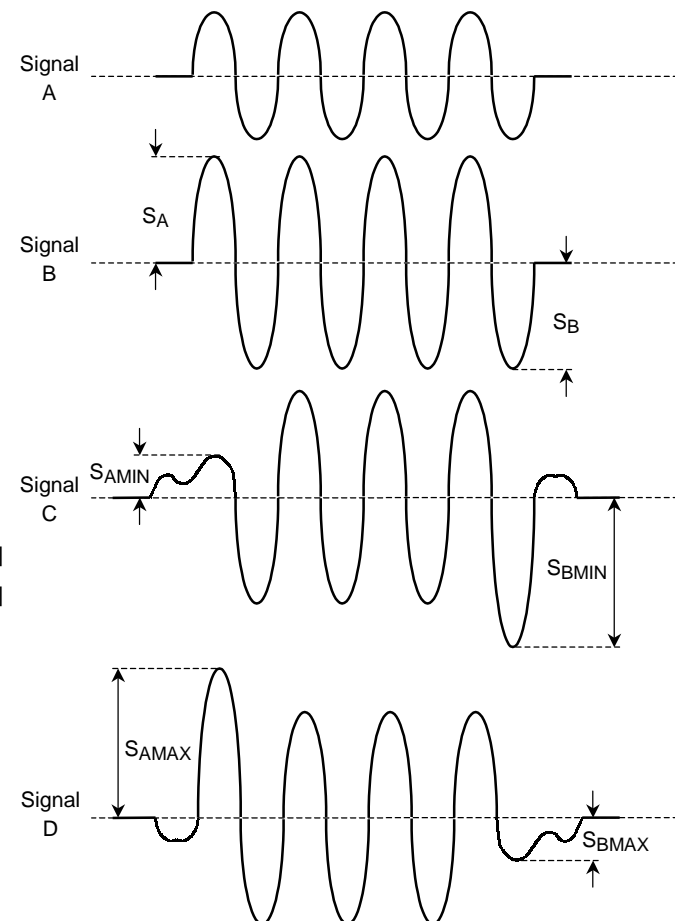


Note No.	Characteristics	Test Conditions					Test Method (Test condition: $V_{CC} = 9\text{ V}/2\text{ V}$ , $T_a = 25 \pm 3^\circ\text{C}$ )
		SW Mode					
		SW71	SW70	SW68	SW64	SW74	
P24	VSM gain	B	B	A	B	ON	<ol style="list-style-type: none"> <li>Input sine wave of <math>F_{VSM}</math> frequency to TPA. Set #68 amplitude to <math>0.02\text{ V}_{p-p}</math>.</li> <li>Turn on SW77 and change VSM gain from minimum (001) to maximum (111). Measure #77 amplitude, <math>V_{001}</math>, <math>V_{011}</math>, <math>V_{100}</math>, <math>V_{101}</math>, <math>V_{110}</math>, and <math>V_{111}</math>. Set input amplitude to <math>0.7\text{ V}_{p-p}</math>, and VSM gain to OFF (000). Measure TP77 amplitude <math>V_{000}</math>.</li> <li>Calculate the following equations.                     <math display="block">G_{V000} = 20 \times \log (V_{000}/0.7) \text{ [dB]}</math> <math display="block">G_{V001} = 20 \times \log (V_{001}/0.02) \text{ [dB]}</math> <math display="block">G_{V010} = 20 \times \log (V_{010}/0.02) \text{ [dB]}</math> <math display="block">G_{V011} = 20 \times \log (V_{011}/0.02) \text{ [dB]}</math> <math display="block">G_{V100} = 20 \times \log (V_{100}/0.02) \text{ [dB]}</math> <math display="block">G_{V101} = 20 \times \log (V_{101}/0.02) \text{ [dB]}</math> <math display="block">G_{V110} = 20 \times \log (V_{110}/0.02) \text{ [dB]}</math> <math display="block">G_{V111} = 20 \times \log (V_{111}/0.02) \text{ [dB]}</math> </li> </ol>
P25	VSM limit	B	B	B	A	ON	<ol style="list-style-type: none"> <li>Input sine wave of frequency <math>F_{VSM}</math> to TPA.</li> <li>Set VSM gain to 111, and #68 amplitude to <math>0.7\text{ V}_{p-p}</math>.</li> <li>Turn on SW77 and measure TP77 amplitude <math>V_{LU}</math> and <math>V_{LD}</math> [<math>\text{V}_{p-p}</math>] as shown in the figure below.</li> </ol> <div style="text-align: center;"> </div>

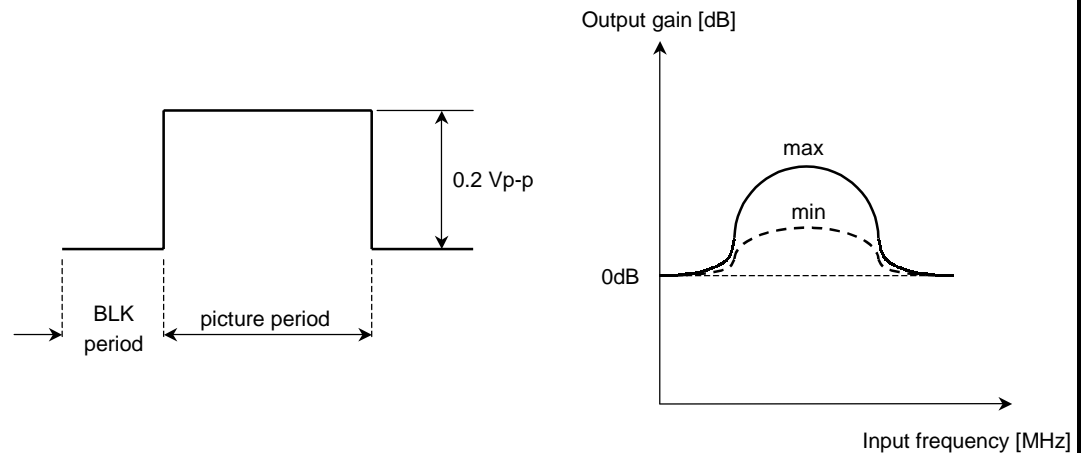
Note No.	Characteristics	Test Conditions					Test Method (Test condition: $V_{CC} = 9 V/2 V$ , $T_a = 25 \pm 3^\circ C$ )
		SW Mode					
		SW71	SW70	SW68	SW64	SW74	
P26	Y delay time switching	B	B	A	B	ON	<ol style="list-style-type: none"> <li>Set unicolor to maximum (1111111), SRT-GAIN to minimum (00000), and input 2T pulse signal (approximately 0.7 V (p-p)) to TPA.</li> <li>Set picture sharpness to center (1000000).</li> <li>Monitor #68 and #12 as shown in the figure below. Measure YDL00 that is the time difference between signals #68 and #12.</li> <li>Set Y/C-DL1 to +5 ns (1), and measure YDL01 as shown in the figure below.</li> <li>Set Y/C-DL1 to 0 ns (0), Y/C-DL2 to +10 ns (1) and measure YDL10 as shown in the figure below.</li> <li>Set Y/C-DL1 to +5 ns (1), Y/C-DL2 to +10 ns (1) and measure YDL11 as shown in the figure below.</li> <li>Determine YDLA, YDLB, and YDLC using the following equations.                     <math display="block">YDLA = YDL01 - YDL00</math> <math display="block">YDLB = YDL10 - YDL00</math> <math display="block">YDLC = YDL11 - YDL00</math> </li> </ol>



Note No.	Characteristics	Test Conditions					Test Method (Test condition: $V_{CC} = 9\text{ V}/2\text{ V}$ , $T_a = 25 \pm 3^\circ\text{C}$ )
		SW Mode					
		SW71	SW70	SW68	SW64	SW74	
P27	Y group delay correction	B	B	A	B	ON	<ol style="list-style-type: none"> <li>Input Multi Burst signal (4.2-MHz frequency, 0.1 Vp-p at #68) of A signal in TPA. Set unicolor to maximum (1111111), SRT-GAIN to minimum (00000), and Color detail enhancer (CDE) to minimum (00000).</li> <li>Set sharpness to flat (DEC [30]), APACON peak frequency to 4.5 M (11), and monitor #12.</li> <li>Sine wave signal A input becomes like signal B on #12 as shown in the figure on the right. Measure <math>S_A</math> and <math>S_B</math>.</li> <li>When group delay correction is set to minimum (0000), signal A becomes like signal C on #12. Measure <math>S_{AMIN}</math> and <math>S_{BMIN}</math>.</li> <li>When group delay correction is set to maximum (1111), signal A becomes like signal D on #12. Measure <math>S_{AMAX}</math> and <math>S_{BMAX}</math>.</li> <li>Calculate the following equations.  <math>G_{AMIN} = 20 \times \log (S_{AMIN}/S_A)</math> [dB]  <math>G_{BMIN} = 20 \times \log (S_{BMIN}/S_B)</math> [dB]  <math>G_{AMAX} = 20 \times \log (S_{AMAX}/S_A)</math> [dB]  <math>G_{BMAX} = 20 \times \log (S_{BMAX}/S_B)</math> [dB] </li> </ol> <p>Note: Sine wave input starts and ends within the picture period such as a burst signal. The wave is not continuous.</p>



Note No.	Characteristics	Test Conditions					Test Method (Test condition: $V_{CC} = 9 V/2 V$ , $T_a = 25 \pm 3^\circ C$ )
		SW Mode					
		SW71	SW70	SW68	SW64	SW74	
P28	Color detail enhancer (CDE)	B	B	A	B	ON	<ol style="list-style-type: none"> <li>Set unicolor to maximum (1111111), SRT-GAIN to minimum (00000), color to center (1000000), and color limiter level to 2 Vp (1). Input SWEEP signal to TPA so that #68 amplitude is 20 mVp-p. Set SW67 to A, and input signal as shown in the figure below (#67 amplitude is 0.2 Vp-p) to TP67.</li> <li>Set picture sharpness to center (1000000), Y detail control to center (1000), and monitor #14 with a spectrum analyzer.</li> <li>When CDE is at minimum (00), set low frequency area to 0dB, and determine peak level <math>G_{CDEMIN}</math>.</li> <li>When CDE is at maximum (11), set low frequency area to 0dB, and determine peak level <math>G_{CDEMAX}</math>.</li> <li>Calculate the following equation.  <math display="block">G_{CDE00} = G_{CDEMAX00} - G_{CDEMIN00}</math> </li> <li>When APACON peak frequency is 13.5 M (00), 9.5 M (01), 6.4 M (10), and 4.5 M (11), calculate <math>G_{CDE00}</math>, <math>G_{CDE01}</math>, <math>G_{CDE10}</math>, and <math>G_{CDE11}</math> respectively using above equation.</li> </ol>



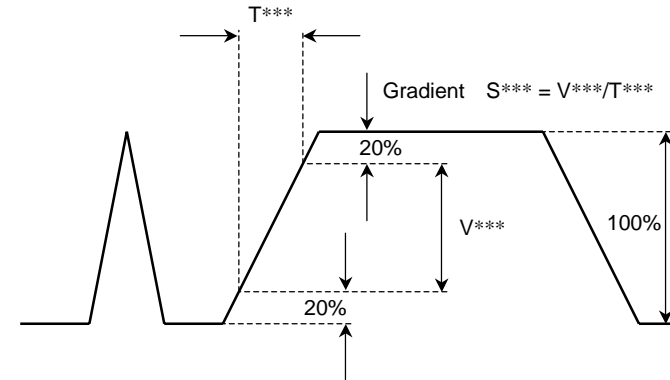
Note No.	Characteristics	Test Conditions					Test Method (Test condition: $V_{CC} = 9 V/2 V$ , $T_a = 25 \pm 3^\circ C$ )
		SW Mode					
		SW71	SW70	SW68	SW64	SW74	
P29	Y detail control range	B	B	A	B	ON	<ol style="list-style-type: none"> <li>1. Set unicolor to maximum (1111111), SRT-GAIN to minimum (00000), CDE to center (10), and APACON peak frequency to 4.5 M (11). Input SWEEP signal to TPA.</li> <li>2. Set #68 amplitude to 20mVp-p.</li> <li>3. Set picture sharpness to center (1000000), Y detail control to maximum (1111), and monitor #12 with a spectrum analyzer.</li> <li>4. Set low frequency area to 0dB, and measure each peak level <math>G_{YDMAX}</math>.</li> <li>5. Set Y detail control to center (1000), and measure peak level <math>G_{YDCEN}</math>.</li> <li>6. Set Y detail control to minimum (0000), and measure peak level <math>G_{YDMIN}</math>.</li> </ol>

## Test Conditions for Color Difference Block 1: YUV input and matrix

### Common Test Condition for Color Difference Block 1: YUV input and matrix

1. SW71 = B, SW70 = B, SW44 = ON, SW18 to SW26 = A, SW77 = OPEN, SW74 = OPEN
2. Transfer BUS control data with preset values.
3. Turn ACB operation switching to ACB OFF (0), and turn high blight color OFF (0).
4. Input sync signal [must be sync with input signal for testing except Sweep.] to #53 (sync input), and set SYNC-IN-SW to 1.

Note No.	Characteristics	Test Conditions				Test Method (Test condition: $V_{CC} = 9 V/2 V$ , $T_a = 25 \pm 3^\circ C$ )
		SW Mode				
		SW68	SW67	SW66	SW64	
S01	Color SRT gain	C	A	A	B	<ol style="list-style-type: none"> <li>1. Set Y mute ON (P-MODE: Y-MUTE, 001), brightness to center (10000000), color to center (1000000), unicolor to maximum (1111111).</li> <li>2. Input 2T pulse signal to TP67 so that #67 amplitude is 423 mVp-p.</li> <li>3. Monitor #14 output waveform. When color SRT peak frequency is 4.5 MHz (0), measure gradients of color SRT gain for minimum (00), center (10), and maximum (11) that are SB00MIN, SB00CEN, and SB00MAX as shown in the figure below. Set SB00MIN to 0dB, calculate <math>G_{SB00CEN} = 20 \times \log (SB00CEN/SB00MIN)</math> and <math>G_{SB00MAX} = 20 \times \log (SB00MAX/SSB00MIN)</math>.</li> <li>4. When color SRT peak is 5.8 MHz (1), measure gradients of color SRT gain for minimum (00), center (10), and maximum (11). Calculate <math>G_{SB01CEN}</math> and <math>G_{SB01MAX}</math>.</li> <li>5. Input 2T pulse signal to TP66 so that #66 amplitude is 300 mVp-p.</li> <li>6. Monitor #12 output waveform. When color SRT peak frequency is 4.5 MHz (0), measure gradients of color SRT gain for minimum (00), center (10), and maximum (11) that are SR00MIN, SR00CEN, and SR00MAX as shown in the figure below. Set SR00MIN to 0dB, calculate <math>G_{SB00CEN} = 20 \times \log (SB00CEN/SB00MIN)</math> and <math>G_{SB00MAX} = 20 \times \log (SB00MAX/SSB00MIN)</math>.</li> <li>7. When color SRT peak is 5.8 MHz (1), measure gradients of color SRT gain for minimum (00), center (10), and maximum (11). Calculate <math>G_{SR01CEN}</math> and <math>G_{SR01MAX}</math>.</li> </ol>
		SW63	SW61	SW60		
		B	B	B		

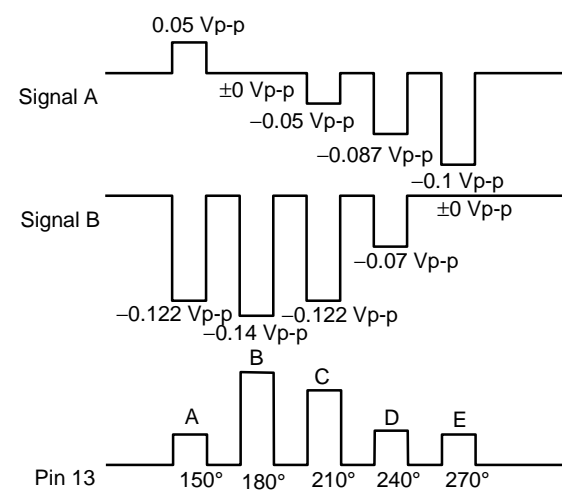


Note No.	Characteristics	Test Conditions				Test Method (Test condition: V <sub>CC</sub> = 9 V/2 V, T <sub>a</sub> = 25 ± 3°C)
		SW Mode				
		SW68	SW67	SW66	SW64	
S02	Dynamic Y/C compensation	C	A	A	B	<ol style="list-style-type: none"> <li>Input 100-kHz sync signal to TP67, and set #67 amplitude to 0.2 V<sub>p-p</sub>.</li> <li>Set Y mute OFF (P-MODE: Normal 1, 000), brightness to center (1000000), color to center (1000000), unicolor to maximum (1111111), and Y/C Gain Comp to minimum (00). Set black stretch point 1 to OFF (000), dark area static Y<sub>γ</sub> gain to minimum (00), light area static Y<sub>γ</sub> gain to maximum (11), and SW1 to B. Apply 5.16 V to #68 from external power supply PS1.</li> <li>Monitor #14 output waveform, and measure amplitude VBDY0.</li> <li>Set Y/C Gain Comp to maximum (11). Set SW1 to B. Set black stretch point 1 to OFF (000), dark area static Y<sub>γ</sub> gain to maximum (11), light area static Y<sub>γ</sub> gain to maximum (00), and monitor #14 amplitude VBDY1.</li> <li>Set Y/C Gain Comp to maximum (11). Switch SW1 to A, and TPI to GND. Set black stretch point 1 to maximum (111), dark area static Y<sub>γ</sub> gain to minimum (00), bright area static Y<sub>γ</sub> gain to maximum (11), and monitor #14 amplitude VBDY2.</li> <li>Calculate the following equations.  <math display="block">GC_{BDY1} = 20 \times \log (VBDY1/VBDY0), GC_{BDY2} = 20 \times \log (VBDY2/VBDY0)</math> </li> <li>Input 100-kHz sync signal to TP5, and repeat the procedure above. Calculate the following equations.  <math display="block">GC_{RDY1} = 20 \times \log (VRDY1/VRDY0), GC_{RDY2} = 20 \times \log (VRDY2/VBDY0)</math> </li> </ol>
		SW63	SW61	SW60	SW74	
		B	B	B	OPEN	

Note No.	Characteristics	Test Conditions				Test Method (Test condition: V <sub>CC</sub> = 9 V/2 V, T <sub>a</sub> = 25 ± 3°C)
		SW Mode				
		SW68	SW67	SW66	SW64	
S03	YUV gain	A/C	A/B	A/B	B	<ol style="list-style-type: none"> <li>1. Set picture mute to OFF (P-MODE: Normal 1, 000), brightness to maximum (11111111), color to center (1000000), and unicolor to maximum (11111111).</li> <li>2. Set SW68 to A. Set SW67 and SW66 to B, and input 100-kHz sine wave to TPA. Set #68 amplitude to 0.2 Vp-p.</li> <li>3. Set SW74 open. Measure #74 amplitude VY00 and VY01 when Y/color difference input mode is set to Y/Cb/Cr (0) and Y/Pb/Pr (1).</li> <li>4. Set SW68 to C, SW67 to A, and SW66 to B. Input 100-kHz sine wave to TP67, and set #67 amplitude to 0.2 Vp-p.</li> <li>5. Measure #14 amplitude VB00 when Y/color difference input mode is set to Y/Cb/Cr (0).</li> <li>6. Measure #14 and #12 amplitude VBB01 and VBR01 when Y/color difference input mode is set to Y/Pb/Pr (1).</li> <li>7. Set SW68 to C, SW67 to B, and SW66 to A. Input 100-kHz sine wave to TP66, and set #66 amplitude to 0.2 Vp-p.</li> <li>8. Measure #12 amplitude VR00 when Y/color difference input mode is set to Y/Cb/Cr (0).</li> <li>9. Measure #14 and #12 amplitude VRB01 and VRR01 when Y/color difference input mode is set to Y/Pb/Pr (1).</li> <li>10. Calculate the following equations.  <math display="block">G_{Y00} = 20 \times \log (VY00/0.2), G_{Y01} = 20 \times \log (VY01/0.2)</math> <math display="block">G_{CBB} = 20 \times \log (VB00/0.2), G_{PBB} = 20 \times \log (VBB01/0.2),</math> <math display="block">G_{PBR} = 20 \times \log (VBR01/0.2)</math> <math display="block">G_{CRR} = 20 \times \log (VR00/0.2), G_{PRB} = 20 \times \log (VRB01/0.2),</math> <math display="block">G_{PRR} = 20 \times \log (VRR01/0.2)</math> </li> </ol>
		SW8	SW9	SW10	SW56	
		B	B	B	OPEN	



Note No.	Characteristics	Test Conditions				Test Method (Test condition: V <sub>CC</sub> = 9 V/2 V, T <sub>a</sub> = 25 ± 3°C)
		SW Mode				
		SW68	SW67	SW66	SW64	
S04	Green stretch	C	A	A	—	1. Input signal B as shown in the figure below from TP67 (Cb/Pb1 input), and signal A from TP66 (Cr/Pr input). 2. Set brightness [06] to maximum (FF). 3. Measure amplitudes A, B, C, D, and E at #13 (Gout) as shown in the figure below. (A00 to E00) 4. Set green stretch [14] data to (08), and repeat the step 3 above. (A01 to E01) 5. Set green stretch [14] data to (10), and repeat the step 3 above. (A10 to E10) 6. Set green stretch [14] data to (18), and repeat the step 3 above. (A11 to E11) 7. Green stretch gain is calculated by the following equations  $\text{GrA01} = \frac{A01}{A00} \quad \text{GrA10} = \frac{A10}{A00} \quad \text{GrA11} = \frac{A11}{A00}$ $\text{GrB01} = \frac{B01}{B00} \quad \text{GrB10} = \frac{B10}{B00} \quad \text{GrB11} = \frac{B11}{B00}$ $\text{GrC01} = \frac{C01}{C00} \quad \text{GrC10} = \frac{C10}{C00} \quad \text{GrC11} = \frac{C11}{C00}$ $\text{GrD01} = \frac{D01}{D00} \quad \text{GrD10} = \frac{D10}{D00} \quad \text{GrD11} = \frac{D11}{D00}$ $\text{GrE01} = \frac{E01}{E00} \quad \text{GrE10} = \frac{E10}{E00} \quad \text{GrE11} = \frac{E11}{E00}$
		SW26	SW25	SW24	SW21	
		A	A	A	A	
		SW19	SW18	—	—	
		A	A	—	—	



## Test Conditions for Color Difference Block 2

### Common Test Conditions for Color Difference Block 2

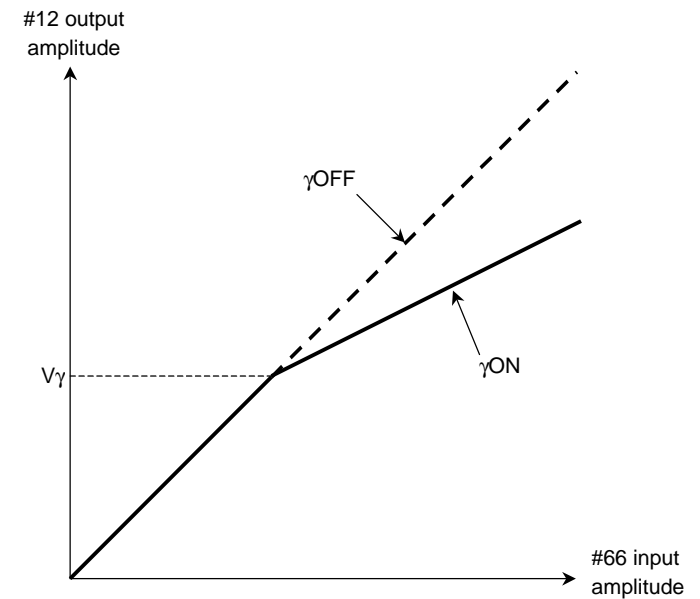
1. SW71 = B, SW70 = B, SW61 to SW63 = B, SW44 = ON, SW40 = B
2. Unless otherwise specified, measure each bus data with preset values.
3. Set the following data.
 

Subaddress (00)	Data (02)
Subaddress (02)	Data (0C)
Subaddress (05)	Data (7F)
Subaddress (06)	Data (6C)
Subaddress (07)	Data (40)
Subaddress (0B)	Data (7F)
Subaddress (0C)	Data (84)
Subaddress (12)	Data (F0)
Subaddress (13)	Data (F0)
Subaddress (15)	Data (00)
Subaddress (18)	Data (00)
Subaddress (1A)	Data (C0)
Subaddress (1B)	Data (E0)
Subaddress (1C)	Data (03)
Subaddress (1D)	Data (78)

Note No.	Characteristics	Test Conditions									Test Method
		SW Mode									
		SW68	SW67	SW66	SW26	SW25	SW24	SW21	SW19	SW18	
A01	Color difference contrast adjustment characteristic	C	A or B	A or B	A	A	A	A	A	A	<ol style="list-style-type: none"> <li>1. Set brightness to maximum, and subaddress (12) data to (F0).</li> <li>2. Input signal 3 (<math>f_0 = 100</math> kHz, picture period amplitude = <math>0.23 V_{p-p}</math>) from pin 66.</li> <li>3. Change unicolor data to maximum (7F), center (40), and minimum (00), and measure pin 12 picture period amplitude <math>V_{UCYMAX}</math>, <math>V_{UCYCENT}</math>, and <math>V_{UCYMIN}</math> respectively.</li> <li>4. Determine unicolor amplitude ratio between maximum and minimum in decibels. (<math>\Delta V_{UCY}</math>)</li> <li>5. Repeat the steps 2 to 4 above with the following pins: Input (picture period amplitude <math>0.2 V_{p-p}</math>) from pin 67, and measure pin 14.</li> </ol>

Note No.	Characteristics	Test Conditions									Test Method
		SW Mode									
		SW68	SW67	SW66	SW26	SW25	SW24	SW21	SW19	SW18	
A02	Color adjustment characteristic	C	A or B	A or B	A	A	A	A	A	A	<ol style="list-style-type: none"> <li>1. Set brightness to maximum, and subaddress (12) data to (F0).</li> <li>2. Input signal 3 (<math>f_0 = 100</math> kHz, picture period amplitude = <math>0.115 V_{p-p}</math>) from pin 66.</li> <li>3. Change color data to maximum (7F), center (40), and minimum (01), and measure pin 12 picture period amplitudes <math>V_{CCYMAX}</math>, <math>V_{CCYCNT}</math>, and <math>V_{CCYMIN}</math> respectively.</li> <li>4. Calculate amplitude ratios of maximum and minimum against color center in decibels. (<math>\Delta V_{CCY}</math>)</li> <li>5. Repeat the steps 2 to 4 above with the following pins: Input (picture period amplitude <math>0.1V_{p-p}</math>) from pin 67 and measure pin 14.</li> </ol>
A03	Color difference halftone characteristic	C	A or B	A or B	A	A	A	A	A	A	<ol style="list-style-type: none"> <li>1. Input signal 3 (<math>f_0 = 100</math> kHz, picture period amplitude <math>0.2 V_{p-p}</math>) from pin 66.</li> <li>2. Measure pin 12 output picture period amplitude <math>v_{HTARY}</math>.</li> <li>3. Apply 1.5 V to pin 79 from external power supply.</li> <li>4. Measure pin 12 output picture period amplitude <math>v_{HTBRY}</math>.</li> <li>5. Calculate <math>GHT_{RY} = v_{HTBRY}/v_{HTARY}</math></li> <li>6. Repeat the steps 1 to 5 above and measure pin 13. Calculate <math>GHT_{GY} = v_{HTBGY}/v_{HTAGY}</math></li> <li>7. Repeat the steps 1 to 5 above and measure pin 67. Calculate <math>GHT_{BY} = v_{HTBBY}/v_{HTABY}</math>.</li> </ol>

Note No.	Characteristics	Test Conditions									Test Method
		SW Mode									
		SW68	SW67	SW66	SW26	SW25	SW24	SW21	SW19	SW18	
A04	Color $\gamma$ characteristic	C	B	A	A	A	A	A	A	A	<ol style="list-style-type: none"> <li>Input signal 2 from pin 66.</li> <li>Increase signal 2 amplitude A. Determine gamma correction point <math>V_{\gamma 1}</math>, <math>V_{\gamma 2}</math>, and <math>V_{\gamma 3}</math> of subaddress data (14). Set subaddress (14) data as follows:                             <ul style="list-style-type: none"> <li>(01) – <math>\gamma</math>OFF</li> <li>(03) – <math>\gamma 1</math>ON</li> <li>(05) – <math>\gamma 2</math>ON</li> <li>(07) – <math>\gamma 3</math>ON</li> </ul>                             Measure #12 output signal amplitude levels and chart a characteristic diagram.                         </li> <li>Determine <math>V_{\gamma}</math> where <math>\gamma</math> starts applying and gradient <math>\Delta</math> at <math>\gamma</math> ON when linearity at <math>\gamma</math> OFF is 1.</li> </ol>



Note No.	Characteristics	Test Conditions									Test Method
		SW Mode									
		SW68	SW67	SW66	SW26	SW25	SW24	SW21	SW19	SW18	
A05	Color limiter characteristic	C	B	A	A	A	A	A	A	A	<ol style="list-style-type: none"> <li>1. Input signal 2 (picture period amplitude = 0.56 Vp-p) from pin 67.</li> <li>2. Set subaddress (14) to (00)/(01), and measure pin 12 output signal picture period amplitude, <math>CLT_0/CLT_1</math>.</li> </ol>
A06	High-bright color gain	C	B	A	A	A	A	A	A	A	<ol style="list-style-type: none"> <li>1. Input signal 2 (picture period amplitude = 0.28 Vp-p) from pin 67.</li> <li>2. Adjust color so that pin 14 output picture period amplitude is 1.2 Vp-p.</li> <li>3. Set subaddress (0B) data to (80) and measure pin 14 output signal picture period amplitude <math>v_{14}</math>.</li> <li>4. Calculate the following equation. <math>HBC_1 = (1.2 - v_{14})/1.2</math></li> </ol>

## Test Conditions for Text Block

### Common Test Conditions for Text Block

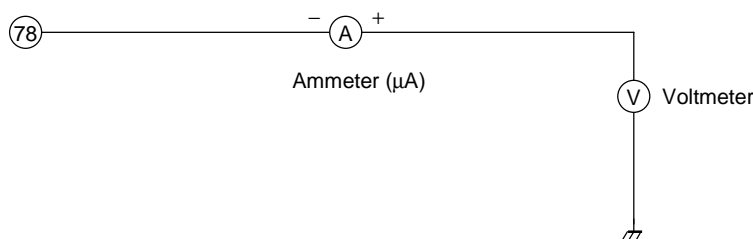
1. SW71 = B, SW70 = B, SW60 to SW64 = B, SW44 = ON, SW40 = B
2. Unless otherwise specified, measure each bus data with preset values.
3. Set the following data.
  - Subaddress (00) Data (02)
  - Subaddress (02) Data (0C)
  - Subaddress (05) Data (7F)
  - Subaddress (06) Data (6C)
  - Subaddress (07) Data (40)
  - Subaddress (0B) Data (7F)
  - Subaddress (0C) Data (84)
  - Subaddress (12) Data (F0)
  - Subaddress (13) Data (F0)
  - Subaddress (15) Data (00)
  - Subaddress (18) Data (00)
  - Subaddress (1A) Data (C0)
  - Subaddress (1B) Data (E0)
  - Subaddress (1C) Data (03)
  - Subaddress (1D) Data (78)

Note No.	Characteristics	Test Conditions									Test Method
		SW Mode									
		SW68	SW67	SW66	SW26	SW25	SW24	SW21	SW19	SW18	
T01	AC gain	A	B	B	A	A	A	A	A	A	1. Input signal 1 ( $f_0 = 100$ kHz, picture period amplitude = 0.2 Vp-p) from pin 68. 2. Measure pins 12, 13, and 14 picture period amplitude, $V_{12}$ , $V_{13}$ , and $V_{14}$ . 3. Calculate AC gain using the following equations. $G_R = V_{12}/0.2$ $G_G = V_{13}/0.2$ $G_B = V_{14}/0.2$
T02	Unicolor adjustment characteristic	A	B	B	A	A	A	A	A	A	1. Input signal 1 ( $f_0 = 100$ kHz, picture period amplitude = 0.2 Vp-p) from pin 68. 2. Change unicolor data to maximum (7F), center (40), and minimum (00) and measure pin 12 picture period amplitude, $V_{uMAX}$ , $V_{uCNT}$ , and $V_{uMIN}$ respectively. 3. Calculate amplitude ratio of $V_{uMAX}$ and $V_{uMIN}$ in decibels ( $\Delta V_u$ )
T03	Brightness adjustment characteristic	A	B	B	A	A	A	A	A	A	1. Input signal 2 from pin 68 and adjust pin 12 picture period output amplitude to 1 Vp-p. 2. Change brightness data to maximum (7F), center (80), and minimum (00) and measure pin 12 voltages, $V_{brMAX}$ , $V_{brCNT}$ , and $V_{brMIN}$ respectively.

Note No.	Characteristics	Test Conditions									Test Method
		SW Mode									
		SW68	SW67	SW66	SW26	SW25	SW24	SW21	SW19	SW18	
T04	White peak slice level	C	B	B	A	A	A	A	A	A	<ol style="list-style-type: none"> <li>1. Set subcontrast to maximum.</li> <li>2. Apply external power supply to pin 68 and gradually increase voltage from 5.8 V.</li> <li>3. When picture period of pin 12 is clipped, measure pin 12 picture period amplitude voltage, <math>V_{wps1}</math>.</li> <li>4. Change subaddress (0C) data to (FC) and repeat the steps 1 to 3 above. (<math>V_{wps2}</math>)</li> </ol>
T05	Black peak slice level	C	B	B	A	A	A	A	A	A	<ol style="list-style-type: none"> <li>1. Apply external power supply to pin 68 and gradually decrease voltage from 5.8 V.</li> <li>2. When picture periods are clipped, measure pins 14, 13, and 12 voltage, <math>V_{bps}</math>.</li> </ol>
T06	RGB output S/N	C	B	B	A	A	A	A	A	A	<ol style="list-style-type: none"> <li>1. Adjust brightness data so that picture period voltage of pin 14 is 2.4 V.</li> <li>2. Set color data to minimum.</li> <li>3. Measure noise levels <math>n_{14}</math>-, <math>n_{13}</math>-, and <math>n_{12}</math>-Vp-p in picture period of pin 14, 13, and 12 with an oscilloscope.</li> <li>4. Calculate S/N. <ul style="list-style-type: none"> <li><math>N_{14} = -20 \times \log [2.3/(0.2 \times n_{14})]</math></li> <li><math>N_{13} = -20 \times \log [2.3/(0.2 \times n_{13})]</math></li> <li><math>N_{12} = -20 \times \log [2.3/(0.2 \times n_{12})]</math></li> </ul> </li> </ol>
T07	Halftone characteristic	A	B	B	A	A	A	A	A	A	<ol style="list-style-type: none"> <li>1. Input signal 1 (<math>f_0 = 100</math> kHz, picture period amplitude 0.2 Vp-p) from pin 68.</li> <li>2. Measure pin 14 picture period amplitude <math>v_{14A}</math>.</li> <li>3. Apply 1.5 V to pin 79 from external power supply.</li> <li>4. Measure pin 14 picture period amplitude <math>v_{14B}</math></li> <li>5. Calculate the following equation. <math>G_{HT1} = v_{14B}/v_{14A}</math></li> <li>6. Stop applying voltage to pin 79. Set subaddress (1A) to data (E2) and measure pin 14-picture period amplitude, <math>v_{14C}</math>.</li> <li>7. Calculate the following equation. <math>G_{HT2} = v_{14C}/v_{14A}</math></li> </ol>

Note No.	Characteristics	Test Conditions									Test Method
		SW Mode									
		SW68	SW67	SW66	SW26	SW25	SW24	SW21	SW19	SW18	
T08	BLK pulse delay time	C	B	B	A	A	A	A	A	A	1. Apply signal shown in the figure (A) below to pin 39 (BLK input), and measure $t_{dON}$ and $t_{dOFF}$ of output signals from pins 12, 13, and 14 shown in the figure (B) below. 



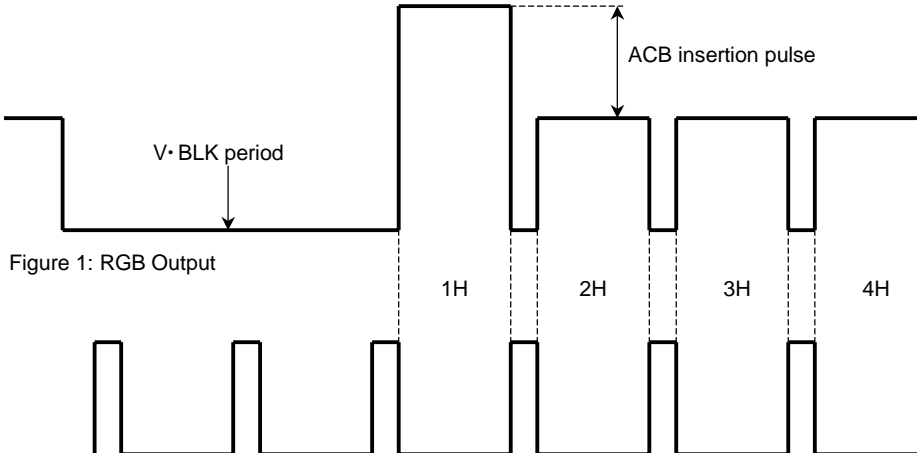
Note No.	Characteristics	Test Conditions									Test Method
		SW Mode									
		SW68	SW67	SW66	SW26	SW25	SW24	SW21	SW19	SW18	
T09	Drive adjustment variable range	A	B	B	A	A	A	A	A	A	<ol style="list-style-type: none"> <li>Input signal 1 (<math>f_0 = 100</math> kHz, picture period amplitude 0.2 Vp-p) from pin 68.</li> <li>Measure picture period amplitude of pin 13 when subaddress (0D) data is changed to maximum (FE), center (80), and minimum (00).</li> <li>Use picture period amplitude at center as the base. Determine amplitude ratio <math>DR_{G1+}</math> and <math>DR_{G1-}</math> at maximum and minimum in decibels.</li> <li>Repeat the steps 1 to 3 above to measure amplitude ratio of pin 14, <math>DR_{B1+}</math> and <math>DR_{B1-}</math> in decibels when subaddress (0E) data is changed.</li> <li>Repeat the steps 1 to 3 above to measure amplitude ratio of pin 13, <math>DR_{G2+}</math> and <math>DR_{G2-}</math> in decibels when subaddress (0E) center data is set to (81) used as the base.</li> <li>Repeat the steps 1 to 3 above to measure picture period amplitude ratio of pin 14, <math>DR_{B2+}</math> and <math>DR_{B2-}</math> in decibels when subaddress (0E) data is changed to maximum (FF), center (81), and minimum (01).</li> <li>Repeat the steps 1 to 3 above to measure picture period amplitude ratio of pin 12, <math>DR_{R1+}</math> and <math>DR_{R2-}</math> in decibels when subaddress (0D) data is changed to maximum (FF), center (81), and minimum (01).</li> <li>Repeat the steps 1 to 3 above to measure picture period amplitude ratio of pin 14, <math>DR_{B3+}</math> and <math>DR_{B3-}</math> in decibels when subaddress (0D) data is set to (81), and subaddress (0E) data is changed.</li> <li>Repeat the steps 1 to 3 above to measure picture period amplitude ratio of pin 13, <math>DR_{G3+}</math> and <math>DR_{G3-}</math> in decibels when subaddress (0E) data is set to (81), and subaddress (0D) data is changed to maximum (FF), center (81), and minimum (01).</li> <li>Repeat the steps 1 to 3 above to measure picture period amplitude ratio of pin 12, <math>DR_{R2+}</math> and <math>DR_{R2-}</math> in decibels when subaddress (0D) data is set to (81), and subaddress (0E) data is changed to maximum (FF), center (81), and minimum (01).</li> </ol>
T10	#78 input impedance	C	B	B	A	A	A	A	A	A	<ol style="list-style-type: none"> <li>Connect external power supply, an ammeter, and a voltmeter to pin 78. Adjust voltage so that current value is set to zero.</li> <li>Measure the current when voltage of pin 78 is increased by 0.2V. (<math>I_{in}</math>)</li> <li>Calculate the following equation. <math>Z_{in53} = 0.2 V / I_{in} (\Omega)</math></li> </ol> 

Note No.	Characteristics	Test Conditions									Test Method
		SW Mode									
		SW68	SW67	SW66	SW26	SW25	SW24	SW21	SW19	SW18	
T11	ACL characteristic	A	B	B	A	A	A	A	A	A	1. Input signal 1 ( $f_0 = 100$ kHz, picture period amplitude $0.2 V_{p-p}$ ) from pin 68. 2. Measure pin 12 picture period amplitude, $v_{ACL1}$ . 3. Apply "DC voltage of pin 78 – 0.8 V" to pin 78 from external power supply and measure pin 12-picture period amplitude, $v_{ACL2}$ . 4. Apply "DC voltage of pin 78 – 1.3 V" to pin 78 from external power supply and measure pin 12-picture period amplitude, $v_{ACL3}$ . 5. Calculate the following equations. $ACL_1 = -20 \times \log (v_{ACL2}/v_{ACL1})$ $ACL_2 = -20 \times \log (v_{ACL3}/v_{ACL1})$
T12	ABL point	C	B	B	A	A	A	A	A	A	1. Measure DC voltage of pin 78, $V_{ABL1}$ . 2. Set subaddress (1B) data to (1C). 3. Apply external voltage to pin 78, and decrease voltage from 6.5 V. When voltage of pin 12 starts changing, measure pin 78 voltage, $V_{ABL2}$ . 4. Change subaddress (1B) data to (3C), (5C), (7C), (9C), (BC), (DC), and (FC) under the status of the step 3 above. Measure pin 78 voltage: $V_{ABL3}$ , $V_{ABL4}$ , $V_{ABL5}$ , $V_{ABL6}$ , $V_{ABL7}$ , $V_{ABL8}$ , and $V_{ABL9}$ . 5. $ABL_{P1} = V_{ABL2} - V_{ABL1}$ $ABL_{P5} = V_{ABL6} - V_{ABL1}$ $ABL_{P2} = V_{ABL3} - V_{ABL1}$ $ABL_{P6} = V_{ABL7} - V_{ABL1}$ $ABL_{P3} = V_{ABL4} - V_{ABL1}$ $ABL_{P7} = V_{ABL8} - V_{ABL1}$ $ABL_{P4} = V_{ABL5} - V_{ABL1}$ $ABL_{P8} = V_{ABL9} - V_{ABL1}$

Note No.	Characteristics	Test Conditions									Test Method
		SW Mode									
		SW68	SW67	SW66	SW26	SW25	SW24	SW21	SW19	SW18	
T13	ABL gain	C	B	B	A	A	A	A	A	A	<ol style="list-style-type: none"> <li>Apply 6.5-V external voltage to pin 78.</li> <li>Set subaddress (1B) data to (00).</li> <li>Set brightness data to maximum.</li> <li>Apply 4.5-V external voltage to pin 78.</li> <li>Change subaddress (1B) data to (00), (04), (08), (0C), (10), (14), (18), and (1C). Repeat the step 3 above, and measure VABL11, VABL12, VABL13, VABL14, VABL15, VABL16, VABL17, and VABL18.</li> <li> <math>ABL_{G1} = VABL11 - VABL10</math>  <math>ABL_{G2} = VABL12 - VABL10</math>  <math>ABL_{G3} = VABL13 - VABL10</math>  <math>ABL_{G4} = VABL14 - VABL10</math>  <math>ABL_{G5} = VABL15 - VABL10</math>  <math>ABL_{G6} = VABL16 - VABL10</math>  <math>ABL_{G7} = VABL17 - VABL10</math>  <math>ABL_{G8} = VABL18 - VABL10</math> </li> </ol>
T14	RGB output mode	C	B	B	A	A	A	A	A	A	<ol style="list-style-type: none"> <li>Adjust brightness data so that picture period voltage of pin 12 is 2.4 V.</li> <li>Set subaddress (1B) data to (01).</li> <li>Measure pins 12, 13, and 14 picture period voltage, <math>V_{12R}</math>, <math>V_{13R}</math>, and <math>V_{14R}</math>.</li> <li>Set subaddress (1B) data to (02), and repeat the step 3 above. Measure pins 12, 13, and 14 picture period voltage, <math>V_{12G}</math>, <math>V_{13G}</math>, and <math>V_{14G}</math>.</li> <li>Set subaddress (1B) data to (03), and repeat the step 3 above. Measure pins 12, 13, and 14 picture period voltage, <math>V_{12B}</math>, <math>V_{13B}</math>, and <math>V_{14B}</math>.</li> </ol>

Note No.	Characteristics	Test Conditions									Test Method
		SW Mode									
		SW68	SW67	SW66	SW26	SW25	SW24	SW21	SW19	SW18	
T15	Y-OUT $\gamma$ characteristic	A	B	B	A	A	A	A	A	A	<ol style="list-style-type: none"> <li>Input RAMP waveform from pin 68. Adjust input amplitude so that picture period amplitude of pin 12 is 2.3 Vp-p.</li> <li>Set subaddress (0C) data to (81).</li> <li>Adjust input amplitude so that picture period amplitude of pin 12 is 2.3 Vp-p.</li> <li>Monitor pin 12. According to the figure below, determine Y-OUT <math>\gamma</math> correction start points <math>\gamma_1</math> and <math>\gamma_2</math>. Also determine ratios of gradients at Y-OUT ON to Y-OUT OFF in decibel. (<math>\Delta_1</math>, <math>\Delta_2</math>, and <math>\Delta_3</math>)</li> </ol> <p>Note: Solid line indicates gamma OFF. Dotted line indicates gamma ON.</p>

Note No.	Characteristics	Test Conditions									Test Method
		SW Mode									
		SW68	SW67	SW66	SW26	SW25	SW24	SW21	SW19	SW18	
T16	White-peak blue characteristic	A	B	B	A	A	A	A	A	A	<ol style="list-style-type: none"> <li>1. Input 0.7-Vp-p RAMP signal from pin 68.</li> <li>2. Set subcontrast data to maximum.</li> <li>3. Set subaddress (1F) data to (04).</li> <li>4. Set subaddress (1E) data to (01), and monitor pin 14. Determine blue stretch start point <math>BS_{Pmin}</math> using the figure below.</li> <li>5. Repeat the step 4 above by changing subaddress (1E) data to (04) and (07). Determine blue stretch start point <math>BS_{PCNT}</math> and <math>BS_{Pmax}</math>.</li> <li>6. Set subaddress (1E) data to (04).</li> <li>7. Monitor pin 14 and calculate ratio of blue stretch ON gradient in relative to blue stretch OFF gradient in decibel (<math>BS_{GCNT}</math>) using the figure below.</li> <li>8. Repeat the step 7 above by changing subaddress (1F) data to (00) and (07). Calculate gradient ratio in decibel (<math>BS_{Gmin}</math> and <math>BS_{Gmax}</math>).</li> </ol> <p>Note: Calculate white-peak blue start point in IRE as setting positive amplitude at pedestal level of output signal to 2.3 Vp-p = 100 IRE.</p>

Note No.	Characteristics	Test Conditions									Test Method
		SW Mode									
		SW68	SW67	SW66	SW26	SW25	SW24	SW21	SW19	SW18	
T17	ACB insertion pulse phase and amplitude or C	A	B	B	A	A	A	A	A	A	<ol style="list-style-type: none"> <li>Input signal 1(<math>f_0 = 100</math> kHz, picture period amplitude = <math>0.2 V_{p-p}</math>) from pin 68. Control drive gain adjustment data so that pins 14 and 13 picture period amplitude equals that of pin 12. Set brightness data to 108.</li> <li>Measure pins 4, 6, and 7 voltage. Apply measured voltages from external power supply.</li> <li>Set subaddress (02) data to (40).</li> <li>Use output signals from pins 12, 13, and 14, and measure ACB insertion pulse phase as shown in the Figure 1.</li> </ol> <p>Note: Take picture period following FBP input fall after <math>V \cdot BLK</math> ends as phase 1H. After next H-BLK, count the phase as 2H, 3H, and so on.</p>  <p>Figure 1: RGB Output</p> <p>Figure 2: FBP Input (#39)</p> <ol style="list-style-type: none"> <li>Monitor pins 12, 13, and 14. Measure ACB insertion pulse amplitudes (level from picture period amplitude at quiescent.): VACB1R, VACB1G, and VACB2B.</li> <li>Set subaddress (02) data to (80), and repeat the step 5 above: VACB2R, VACB2G, and VACB2B.</li> <li>Set subaddress (02) data to (C0), and repeat the step 5 above: VACB3R, VACB3G, and VACB3B.</li> </ol>

Note No.	Characteristics	Test Conditions									Test Method
		SW Mode									
		SW68	SW67	SW66	SW26	SW25	SW24	SW21	SW19	SW18	
T18	IK input amplitude	A or C	B	B	A	A	A	A	A	A	1. Input signal 1( $f_0 = 100$ kHz, picture period amplitude = 0.2 Vp-p) from pin 68. Control drive gain adjustment data so that pins 14 and 13 picture period amplitude equals that of pin 12. 2. Set subaddress (02) data to (40). 3. Measure voltage amplitude of pin-8 input signal in ACB insertion period. $1H = IK_R$ $2H = IK_G$ $3H = IK_B$
T19	IK input cover range	C	B	B	A	A	A	A	A	A	1. Input signal 1( $f_0 = 100$ kHz, picture period amplitude = 0.2 Vp-p) from pin 68. Control drive gain adjustment data so that pins 14 and 13 picture period amplitude equals that of pin 12. 2. Set subaddress (02) data to (40). 3. Measure pin 8 DC voltage in V·BLK period. (#8VBLK) 4. Apply the current externally to pin 8. 5. Measure DC voltage of pin 8 in V·BLK period when pin-12 picture period voltage begins to be decreased. (#8VBLK+) 6. Apply current outward from pin 8. 7. Measure DC voltage of pin 8 in V·BLK period when pin-12 picture period voltage begins to be increased. (#8VBLK-) 8. $DIK_{in+} = (\#8VBLK+) - (\#8VBLK)$ $DIK_{in-} = (\#8VBLK-) + (\#8VBLK)$
T20	Analog RGB gain	A	B	B	A or B	A or B	A or B	A	A	A	1. Input signal 1( $f_0 = 100$ kHz, picture period amplitude = 0.2 Vp-p) from pin 68. Control drive gain adjustment data so that pins 14 and 13 picture period amplitude equals that of pin 12. 2. Apply 5-V external voltage to pin 2. 3. Input signal 1( $f_0 = 100$ kHz, picture period amplitude = 0.2 Vp-p) from pin 24. 4. Measure pin 12 picture period amplitude, v12R. 5. Repeat the steps 3 and 4 above with the following pins: Input from pin 25, and measure output from pin 13 (v13G). Input from pin 26, and measure output from pin 14 (v14B). 6 Calculate the following equations. $GTXR = v12R/0.2$ $GTXG = v13G/0.2$ $GTXB = v14B/0.2$
T21	Analog RGB white peak slice level	A	B	B	A	A	A	A	A	A	1. Input signal 1( $f_0 = 100$ kHz, picture period amplitude = 0.2 Vp-p) from pin 68. Control drive gain adjustment data so that pins 14 and 13 picture period amplitude equals that of pin 12. 2. Apply 5-V external voltage to pin 2. 3. Set RGB contrast data to maximum (7F). 4. Input signal 2 to pin 24. Gradually increase picture amplitude, and measure picture period amplitude voltage when output from pin 12 is clipped. 5. Repeat the steps 3 and 4 above with following pins: Input from pin 25 and measure output from pin 13. Input from pin 26 and measure output pin 14.

Note No.	Characteristics	Test Conditions									Test Method
		SW Mode									
		SW68	SW67	SW66	SW26	SW25	SW24	SW21	SW19	SW18	
T22	Analog RGB black peak limit level	A	B	B	A	A	A	A	A	A	<ol style="list-style-type: none"> <li>1. Input signal 1 (<math>f_0 = 100</math> kHz, picture period amplitude = 0.2 Vp-p) from pin 68. Control drive gain adjustment data so that pins 14 and 13 picture period amplitude equals that of pin 12.</li> <li>2. Apply 5-V external voltage to pin 2.</li> <li>3. Set RGB contrast data to maximum (7F).</li> <li>4. Input signal 2 to pin 24. Gradually decrease picture amplitude, and measure picture period amplitude voltage when output from pin 12 is clipped.</li> <li>5. Repeat the step 4 above with the following pins: Input from pin 25 and measure output from pin 13. Input from pin 26 and measure output pin 14.</li> </ol>
T23	RGB contrast adjustment characteristic	A	B	B	A or B	A or B	A or B	A	A	A	<ol style="list-style-type: none"> <li>1. Input signal 1 (<math>f_0 = 100</math> kHz, picture period amplitude = 0.2 Vp-p) from pin 68. Control drive gain adjustment data so that pins 14 and 13 picture period amplitude equals that of pin 12.</li> <li>2. Apply 5-V external voltage to pin 2.</li> <li>3. Input signal 1 (<math>f_0 = 100</math> kHz, picture period amplitude = 0.2 Vp-p) from pin 24.</li> <li>4. RGB contrast data to maximum (7F), center (40), and minimum (00). Measure pin 12 picture period amplitudes <math>V_{UTXR}</math> (maximum, center, and minimum) respectively.</li> <li>5. Calculate amplitude ratio of maximum and minimum in decibels.</li> <li>6. Repeat the steps 4 and 5 above with the following pins: Input from pin 25 and measure pin 13. Input from pin 26 and measure pin 14.</li> </ol>
T24	Analog RGB brightness adjustment characteristic	A	B	B	A or B	A or B	A or B	A	A	A	<ol style="list-style-type: none"> <li>1. Input signal 1 (<math>f_0 = 100</math> kHz, picture period amplitude = 0.2 Vp-p) from pin 68. Control drive gain adjustment data so that pins 14 and 13 picture period amplitude equals that of pin 12.</li> <li>2. Input signal 2 from pins 26, 25, and 24.</li> <li>3. Apply 5-V external voltage to pin 2.</li> <li>4. Adjust amplitude A of signal 2 so that picture period amplitude of pin 12 is 0.5 Vp-p.</li> <li>5. Change RGB brightness data to maximum (FE), center (80), and minimum (00). Measure pins 12, 13, and 14 picture period voltage <math>V_{bTX}</math> (maximum, center, and minimum) respectively.</li> </ol>
T25	Analog RGB mode switching transfer characteristic	C	B	B	A	A	A	A	A	A	<ol style="list-style-type: none"> <li>1. Set RGB brightness data to maximum (FE).</li> <li>2. Input signal 4 (signal amplitude = 1.5 Vp-p) from pin 2.</li> <li>3. Measure input/output transfer characteristics using pin 12 according to the figure T-2.</li> <li>4. Repeat the steps 2 and 3 above with the following pins: Input from pin 25 and measure pin 13. Input from pin 24 and measure pin 14.</li> <li>5. Calculate maximum inter-axial rise/fall transfer delay time, using the data measured above.</li> </ol>



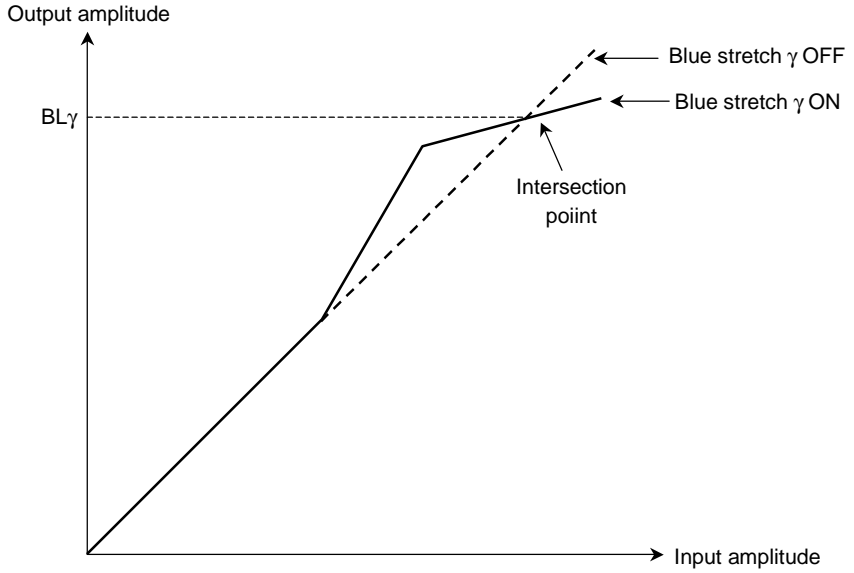
Note No.	Characteristics	Test Conditions									Test Method
		SW Mode									
		SW68	SW67	SW66	SW26	SW25	SW24	SW21	SW19	SW18	
T26	Text ACL characteristic	A	B	B	A	A	B	A	A	A	<ol style="list-style-type: none"> <li>Input signal 1(<math>f_0 = 100</math> kHz, picture period amplitude = 0.2 Vp-p) from pin 68. Control drive gain adjustment data so that pins 14 and 13 picture period amplitude equals that of pin 12.</li> <li>Apply 5-V external voltage to pin 2.</li> <li>Input signal 1(<math>f_0 = 100</math> kHz, picture period amplitude = 0.2 Vp-p) from pin 24.</li> <li>Measure pin 12 picture period amplitude, vTXACL1.</li> <li>Apply "pin 78 DC voltage – 0.8 V" to pin 78 from external power supply, and measure pin 12-picture period amplitude, vTXACL2.</li> <li>Apply "pin 78 DC voltage – 1.3 V" to pin 78 from external power supply, and measure pin 12-picture period amplitude, vTXACL3.</li> <li><math>TXACL_1 = -20 \times \log (vTXACL2/vTXACL1)</math> <math>TXACL_2 = -20 \times \log (vTXACL3/vTXACL1)</math></li> </ol>
T27	Analog OSD gain	A	B	B	A	A	A	A or B	A or B	A or B	<ol style="list-style-type: none"> <li>Input signal 1(<math>f_0 = 100</math> kHz, picture period amplitude = 0.2 Vp-p) from pin 68. Control drive gain adjustment data so that pins 14 and 13 picture period amplitude equals that of pin 12.</li> <li>Apply 5-V external voltage to pins 1 and 80.</li> <li>Input signal 1(<math>f_0 = 100</math> kHz, picture period amplitude = 0.2 Vp-p) from pin 18.</li> <li>Measure pin 12 picture period amplitude, v12R.</li> <li>Repeat the steps 3 and 4 above with the following pins: Input from pin 19, and measure pin 13. Input from pin 21 and measure pin 14. (v13G and v14B)</li> <li>Calculate the following equations. <math>GOSDR = v12R/0.2</math> <math>GOSDG = v13G/0.2</math> <math>GOSDB = v14B/0.2</math></li> </ol>
T28	Analog OSD input white peak slice level	A	B	B	A	A	A	A	A	A	<ol style="list-style-type: none"> <li>Input signal 1(<math>f_0 = 100</math> kHz, picture period amplitude = 0.2 Vp-p) from pin 68. Control drive gain adjustment data so that pins 14 and 13 picture period amplitude equals that of pin 12.</li> <li>Apply 5-V external voltage to pins 1 and 80.</li> <li>Input signal 2 from pin 18. Gradually increase picture amplitude, and measure picture period amplitude voltage when output from pin 12 is clipped.</li> <li>Repeat the step 3 above with the following pins: Input from pin 19, and measure pin 13. Input from pin 21, and measure pin 14.</li> </ol>
T29	Analog OSD black peak limit level	A	B	B	A	A	A	A	A	A	<ol style="list-style-type: none"> <li>Input signal 1(<math>f_0 = 100</math> kHz, picture period amplitude = 0.2 Vp-p) from pin 68. Control drive gain adjustment data so that pins 14 and 13 picture period amplitude equals that of pin 12.</li> <li>Apply 5-V external voltage to pins 1 and 80.</li> <li>Input signal 2 from pin 18. Gradually decrease picture amplitude, and measure picture period amplitude voltage when output from pin 12 is clipped.</li> <li>Repeat the step 3 above with the following pins: Input from pin 19, and measure pin 13. Input from pin 21, and measure pin 14.</li> </ol>

Note No.	Characteristics	Test Conditions									Test Method
		SW Mode									
		SW68	SW67	SW66	SW26	SW25	SW24	SW21	SW19	SW18	
T30	OSD contrast adjustment characteristic	A	B	B	A	A	A	A or B	A or B	A or B	<ol style="list-style-type: none"> <li>1. Input signal 1(<math>f_0 = 100</math> kHz, picture period amplitude = 0.2 Vp-p) from pin 68. Control drive gain adjustment data so that pins 14 and 13 picture period amplitude equals that of pin 12.</li> <li>2. Apply 5-V external voltage to pins 1 and 80.</li> <li>3. Input signal 1(<math>f_0 = 100</math> kHz, picture period amplitude = 0.2 Vp-p) from pin 18.</li> <li>4. Change OSD contrast data to (11), (10), (01), and (00). Measure pin 12 picture period amplitude <math>V_{uOSDR}</math> (11), (10), (01), and (00) respectively.</li> <li>5. Repeat the steps 3 and 4 above with the following pins: Input from pin 19, and measure pin 13, <math>V_{uOSDG}</math> (11), (10), (01), and (00). Input from pin 21, and measure pin 14, <math>V_{uOSDB}</math> (11), (10), (01), and (00).</li> </ol>
T31	Analog OSD brightness adjustment characteristic	C	B	B	A	A	A	A	A	A	<ol style="list-style-type: none"> <li>1. Input signal 1(<math>f_0 = 100</math> kHz, picture period amplitude = 0.2 Vp-p) from pin 68. Control drive gain adjustment data so that pins 14 and 13 picture period amplitude equals that of pin 12.</li> <li>2. Apply 5-V external voltage to pins 1 and 80.</li> <li>3. Change OSD brightness data (subaddress 1D) to (38), (78), (B8), and (F8), and measure picture period voltage of pins 12, 13, and 14 respectively.                       Data (38) = <math>V_{brOSD0}</math>                      Data (78) = <math>V_{brOSD1}</math>                      Data (B8) = <math>V_{brOSD2}</math>                      Data (F8) = <math>V_{brOSD3}</math> </li> </ol>
T32	Analog OSD mode switching transfer characteristic	C	B	B	A	A	A	A	A	A	<ol style="list-style-type: none"> <li>1. Set OSD brightness data to maximum (11).</li> <li>2. Input signal 4 (signal amplitude = 4.5 Vp-p) from pin 1.</li> <li>3. Measure input/output transfer characteristics using pin 12 according to the figure T-2.</li> <li>4. Repeat the steps 2 and 3 above, and measure pins 13 and 14.</li> <li>5. Calculate maximum inter-axial rise/fall transfer delay time, using the data measured above.</li> <li>6. Repeat the steps 1 to 5 above with the following pin. Input signal 4 (signal amplitude 4.5 Vp-p) from pin 80.</li> </ol>

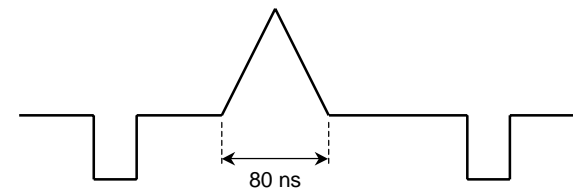
Note No.	Characteristics	Test Conditions									Test Method
		SW Mode									
		SW68	SW67	SW66	SW26	SW25	SW24	SW21	SW19	SW18	
T33	OSD ACL characteristic	A	B	B	A	A	A	A	A	B	<ol style="list-style-type: none"> <li>1. Input signal 1 (<math>f_0 = 100</math> kHz, picture period amplitude = 0.2 Vp-p) from pin 68. Control drive gain adjustment data so that pins 14 and 13 picture period amplitude equals that of pin 12.</li> <li>2. Set subaddress (07) data to (01).</li> <li>3. Apply 5-V external voltage to pins 1 and 80.</li> <li>4. Input signal 1 (<math>f_0 = 100</math> kHz, picture period amplitude = 0.2 Vp-p) from pin 18.</li> <li>5. Measure pin 12 picture period amplitude, vOSDACL1.</li> <li>6. Apply "pin 78 DC voltage – 0.8 V" to pin 78 from external power supply, and measure pin 12-picture period amplitude, vOSDACL2.</li> <li>7. Apply "pin 78 DC voltage – 1.3 V" to pin 78 from external power supply, and measure pin 12-picture period amplitude, vOSDACL3.</li> <li>8. <math>OSDACL_1 = -20 \times \log (vOSDACL2/vOSDACL1)</math> <math>OSDACL_2 = -20 \times \log (vOSDACL3/vOSDACL1)</math></li> <li>9. OSDACL3、 OSDACL4 Change subaddress (07) data to (80), and repeat the steps 6 to 8 above to measure OSDACL3 and OSDACL4.</li> </ol>

Note No.	Characteristics	Test Conditions									Test Method
		SW Mode									
		SW68	SW67	SW66	SW26	SW25	SW24	SW21	SW19	SW18	
T34	OSD blending characteristic	A ↓ C	B	B	A	A	A	A	A	B	<ol style="list-style-type: none"> <li>1. Input signal 1 (<math>f_0 = 100</math> kHz, picture period amplitude = 0.2 Vp-p) from pin 68.</li> <li>2. Measure pins 14, 13, and 12 picture period amplitude, v14a, v13a, and v12a.</li> <li>3. Apply 5-V external voltage to pin 80.</li> <li>4. Measure pins 14, 13, and 12 picture period amplitude, v14b, v13b, and v12b.</li> <li>5. Calculate v14b amplitude in relation to v14a, v13b amplitude in relation to v13a, and v12b amplitude in relation to v12a in decibel: <math>\alpha14TV1</math>, <math>\alpha13TV1</math>, and <math>\alpha12TV1</math>.</li> <li>6. Apply 5-V external voltage to pin 1, and repeat the steps 3 to 5 above: <math>\alpha14TV2</math>, <math>\alpha13TV2</math>, and <math>\alpha12TV2</math>.</li> <li>7. Apply 5-V external voltage to pins 1 and 80, and repeat the steps 3 to 5 above: <math>\alpha14TV3</math>, <math>\alpha13TV3</math>, and <math>\alpha12TV3</math>.</li> <li>8. Set SW68 to C. Set SW21, 19, and 18 to B.</li> <li>9. Input signal 1 (<math>f_0 = 100</math> kHz, picture period amplitude = 0.2 Vp-p) from pins 21, 19, and 18.</li> <li>10. Apply 5-V external voltage to pins 1 and 80.</li> <li>11. Measure pins 14, 13, and 12 picture period amplitude, v14c, v13c, and v12c.</li> <li>12. Apply 5-V external voltage to pin 1.</li> <li>13. Measure pins 14, 13, and 12 picture period amplitude, v14d, v13d, and v12d.</li> <li>14. Calculate v14d amplitude in relation to v14c, v13d amplitude in relation to v13c, and v12d amplitude in relation to v12c in decibel: <math>\alpha14OSD1</math>, <math>\alpha13OSD1</math>, and <math>\alpha12OSD1</math>.</li> <li>15. Apply 5-V external voltage to pin 80, and repeat the steps 12 to 14 above: <math>\alpha14OSD2</math>, <math>\alpha13OSD2</math>, and <math>\alpha12OSD2</math>.</li> <li>16. Apply 5-V external voltage to pins 1 and 80, and repeat the steps 12 to 14 above: <math>\alpha14OSD3</math>, <math>\alpha13OSD3</math>, and <math>\alpha12OSD3</math>.</li> </ol>

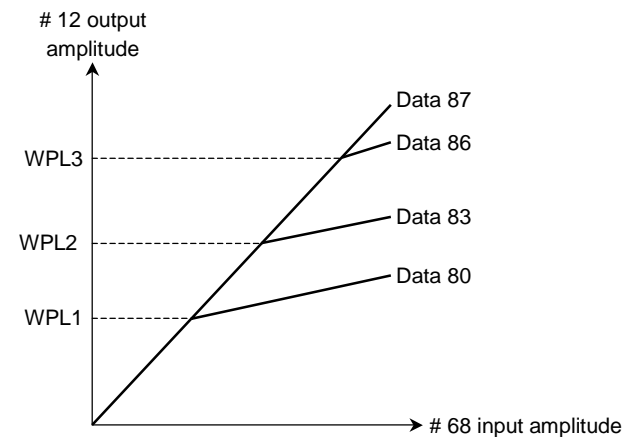
Note No.	Characteristics	Test Conditions									Test Method
		SW Mode									
		SW68	SW67	SW66	SW26	SW25	SW24	SW21	SW19	SW18	
T35	Blue stretch point/gain	A	B	B	A	A	A	A	A	A	<ol style="list-style-type: none"> <li>1. Input RAMP signal 0.7 Vp-p from pin 68.</li> <li>2. Set subcontrast data to maximum.</li> <li>3. Set subaddress (15) data to (0C).</li> <li>4. Set subaddress (1A) data to (C0), monitor pin 14, and measure blue stretch start point using the figure below (BLP<sub>min</sub>).</li> <li>5. Set subaddress (1A) data to (CC), and repeat the step 4 above. (BLP<sub>max</sub>)</li> <li>6. Set subaddress (1A) data to (C4).</li> <li>7. Monitor pin 14 and measure gradient at blue stretch ON in decibel in relation to the one at blue stretch OFF according to the figure below. (BLG<sub>max</sub>)</li> <li>8. Set subaddress (15) data to (04), and repeat the step 7 above. (BLG<sub>min</sub>)</li> </ol> <p>Note: Calculate blue stretch start point in IRE as setting positive amplitude at pedestal level of output signal to 2.3 Vp-p = 100 IRE.</p>

Note No.	Characteristics	Test Conditions									Test Method
		SW Mode									
		SW68	SW67	SW66	SW26	SW25	SW24	SW21	SW19	SW18	
T36	Blue stretch gamma correction	A	B	B	A	A	A	A	A	A	<ol style="list-style-type: none"> <li>1. Input RAMP signal 0.7 Vp-p from pin 68.</li> <li>2. Set subcontrast data to maximum.</li> <li>3. Set subaddress (15) data to (08).</li> <li>4. Set subaddress (09) data to (81).</li> <li>5. Monitor pin 14 and measure amplitude of the intersection point of blue stretch <math>\gamma</math> OFF and blue stretch <math>\gamma</math> ON according to the figure below. Calculate pin 14 output amplitude in IRE as setting positive amplitude at pedestal level of output signal to 2.3 Vp-p = 100 IRE.</li> <li>6. Set subaddress (1A) data to (C4), (C8), and (CC). Repeat the step 5 above. (BL<math>\gamma</math>2, BL<math>\gamma</math>3, and BL<math>\gamma</math>4)</li> </ol> 

Note No.	Characteristics	Test Conditions									Test Method
		SW Mode									
		SW68	SW67	SW66	SW26	SW25	SW24	SW21	SW19	SW18	
T37	White letters improvement	A	B	B	A	A	A	A	A	A	<ol style="list-style-type: none"> <li>Apply a pulse to pin 68 as shown in Figure A.</li> <li>Monitor # 12 output waveform. Plot # 12 output amplitude when changing # 68 input signal amplitude from 0 to 120 IRE (0.857 Vp-p) (See Figure B below).</li> <li>Set subaddress (19) data to (80).</li> <li>Monitor # 12 output waveform. Plot # 12 output amplitude when changing # 68 input signal amplitude from 0 to 120 IRE (0.857 Vp-p). Then, compare to the plot in the step 2, calculate a point where a gradient changes (WPL1).</li> <li>Repeat the step 4 above by changing subaddress (19) data to (83) and (86). Calculate points where gradients change (WPL2, WPL3).</li> </ol>



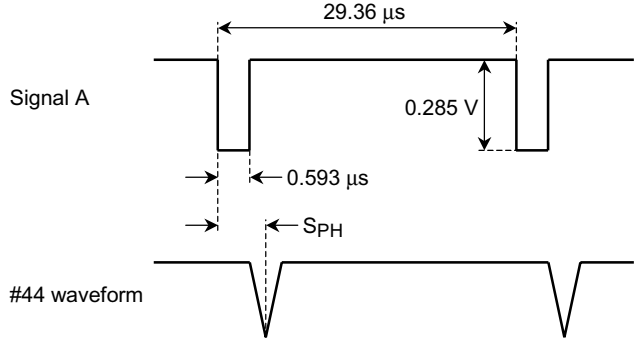
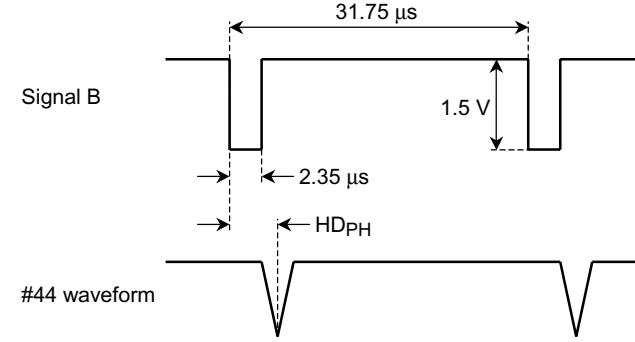
**Figure A**



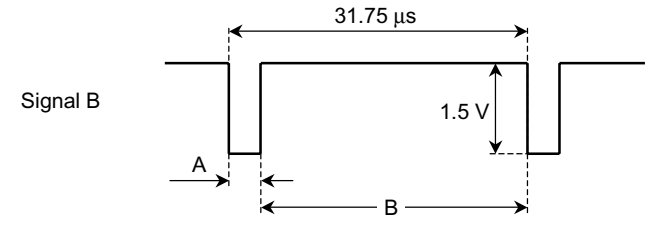
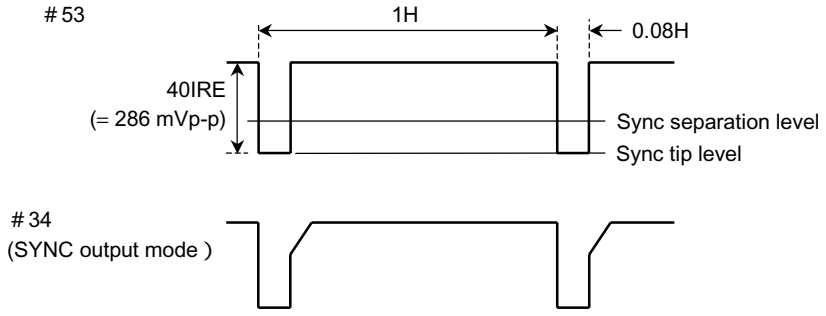
**Figure B**

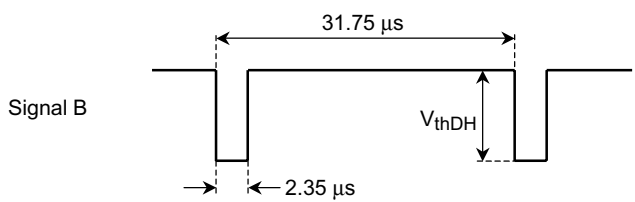
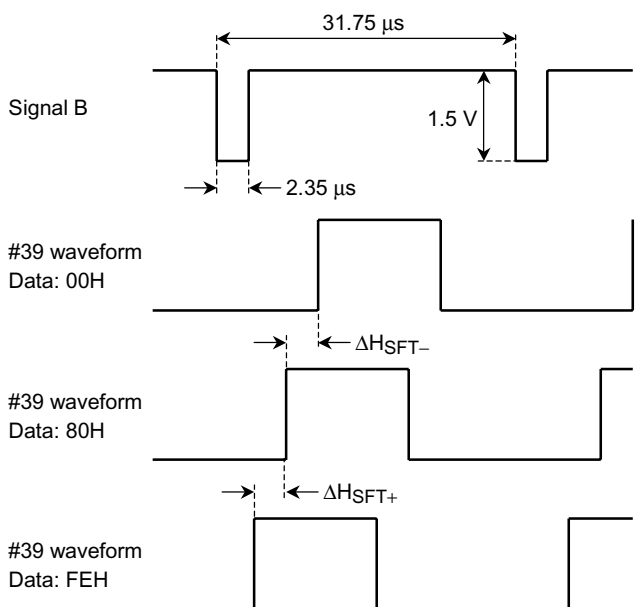
**Test Condition for Synchronization Block**

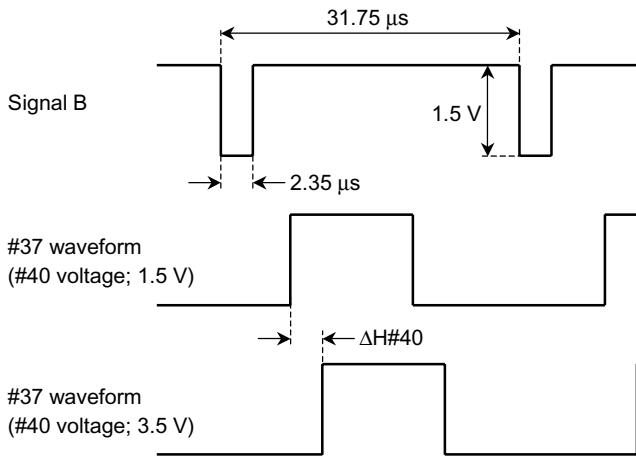
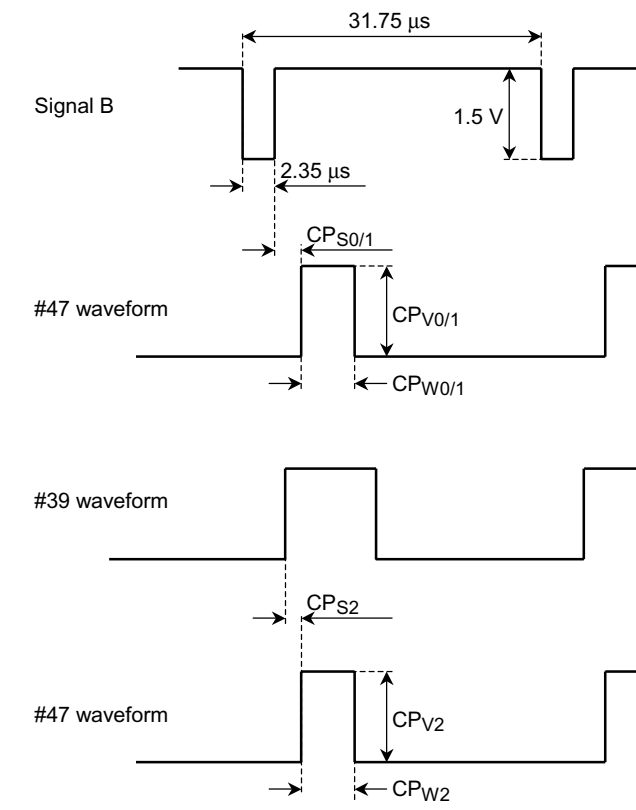
**Common Test Conditions for Synchronization Block: unless otherwise specified,  $V_{CC} = 9\text{ V}$ ,  $T_a = 25^\circ\text{C}$ , bus data; preset value, SW68 = A, SW53 = A, SW INPUT = B, SW44 = ON, SW41 = OPEN, SW40 = B, SW39a = B, SW39b = OPEN, SW37 = B**

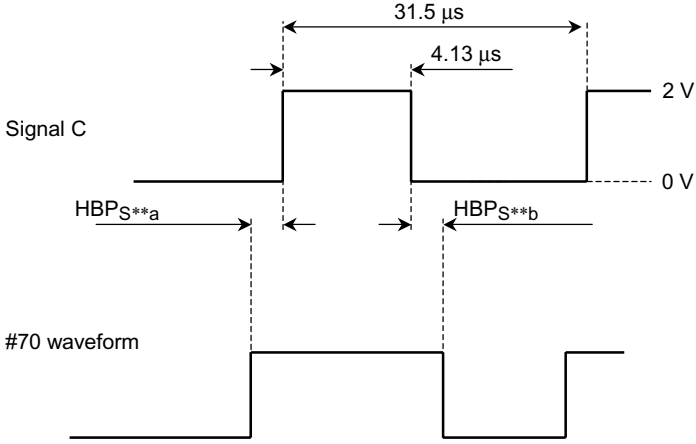
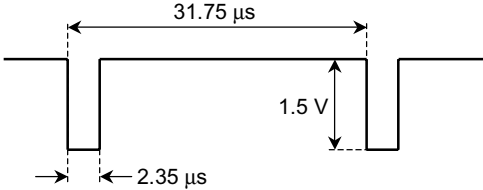
Note	Characteristics	Test Conditions
HA01	Sync input horizontal sync phase	<ol style="list-style-type: none"> <li>Input signal A (as shown in the figure below) to TPA. Set subaddress (00) data to 82H.</li> <li>Monitor # 53 (Sync input) and #44 (AFC filter) waveforms. Measure phase difference (<math>S_{PH}</math>).</li> </ol> 
HA02	HD input horizontal sync phase	<ol style="list-style-type: none"> <li>Set subaddress (00) data to 40H.</li> <li>Input signal B (as shown in the figure below) to TP50.</li> <li>Monitor #50 (Sync input) and #44 (AFC filter) waveforms. Measure phase difference (<math>HD_{PH}</math>).</li> </ol> 

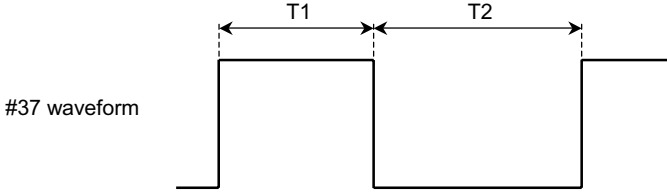


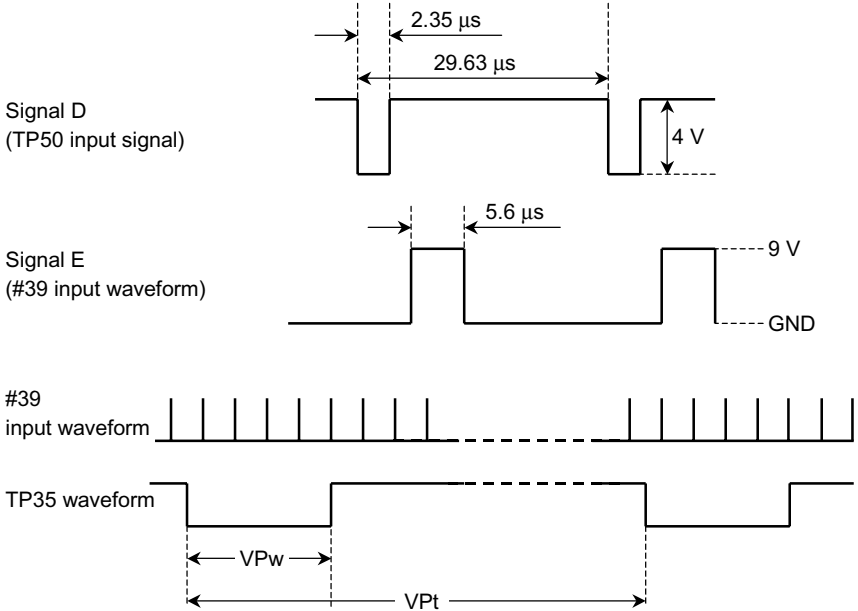
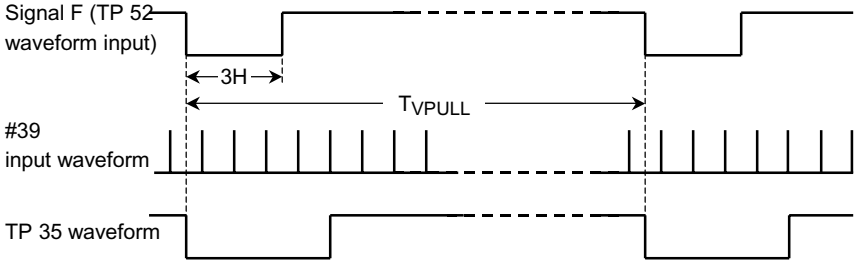
Note	Characteristics	Test Conditions
HA03	Polarity detection range	<ol style="list-style-type: none"> <li>Set subaddress (00) data to 40H.</li> <li>Input signal B (as shown in the figure below) to TP50 pin.</li> <li>Decrease signal B duty from 10% (to shorter negative polarity period) and measure signal B duty (HD<sub>DUTY1</sub>) when #50 input signal phase no longer locks with that of #37 (H-OUT).</li> <li>Increase signal B duty from 10% (to longer negative polarity period) and measure signal B duty (HD<sub>DUTY2</sub>) when #39 (FBP input) phase changes in relation to signal B.</li> <li>Further increase signal B duty (to longer negative polarity period) and measure signal B duty (HD<sub>DUTY3</sub>) when #50 input signal phase no longer locks with that of #37 (H-OUT).</li> <li>Decrease signal B duty from 90 % (to shorter negative polarity period) and measure signal B duty (HD<sub>DUTY4</sub>) when #39 (FBP input) phase changes in relation to signal B.</li> </ol>  <p>Duty = A/B × 100% (0 to 100%)</p>
HA04	Sync input threshold amplitude	<ol style="list-style-type: none"> <li>Set subaddress (00) data to 82H, and TEST mode to 01.</li> <li>Connect variable power supply to #53 via 20-kΩ resistor.</li> <li>Set variable power supply voltage to 0 V, and measure #53 voltage. (SYNC_TIP_00) Also check that #34 voltage is set to Low (GND level).</li> <li>Increase variable power supply voltage so that #34 voltage becomes High (VCC level). Measure #53 voltage. (SYNC_OFF_00)</li> <li>Calculate the following equation to determine SYNC input separation level at SYNC separation level is 00. <math>V_{thS00} = (SYNC\_OFF\_00 - SYNC\_TIP\_00)/0.286 \times 100</math></li> <li>Change SYNC separation level to 01, 10, and 11. Calculate following equations to determine <math>V_{thS01}</math>, <math>V_{thS10}</math>, and <math>V_{thS11}</math>.                     <math display="block">V_{thS01} = (SYNC\_OFF\_01 - SYNC\_TIP\_01)/0.286 \times 100</math> <math display="block">V_{thS10} = (SYNC\_OFF\_10 - SYNC\_TIP\_10)/0.286 \times 100</math> <math display="block">V_{thS11} = (SYNC\_OFF\_11 - SYNC\_TIP\_11)/0.286 \times 100</math> </li> </ol>  <p># 53</p> <p>40IRE (= 286 mVp-p)</p> <p>1H</p> <p>0.08H</p> <p>Sync separation level</p> <p>Sync tip level</p> <p># 34 (SYNC output mode)</p>

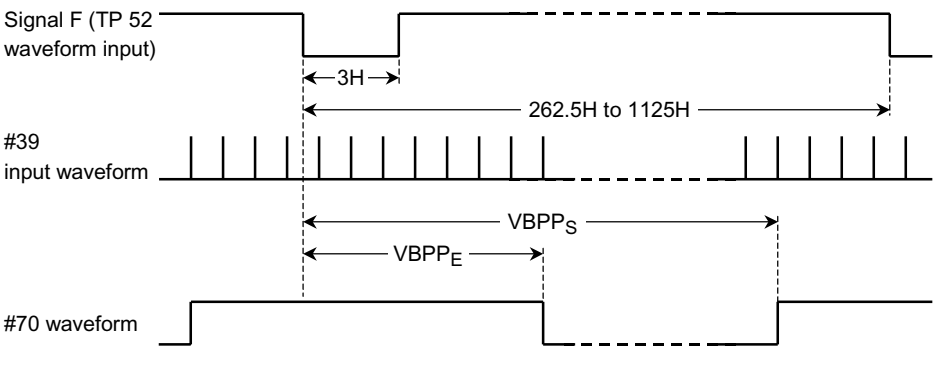
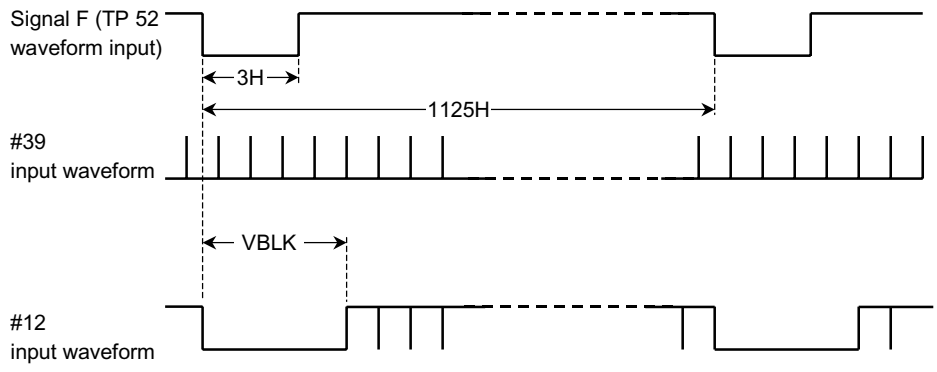
Note	Characteristics	Test Conditions
HA05	HD input threshold amplitude	<ol style="list-style-type: none"> <li>Set subaddress (00) data to 40H.</li> <li>Input signal B (as shown in the figure below) to TP50.</li> <li>Increase signal B amplitude from 0 V<sub>p-p</sub>. When #37 (H-OUT) phase locks with that of signal B, measure signal B amplitude V<sub>thDH</sub>.</li> </ol> 
HA06	Horizontal picture phase adjustment variable range	<ol style="list-style-type: none"> <li>Set subaddress (00) data to 40H.</li> <li>Input signal B (the figure is shown below) to TP50.</li> <li>Change subaddress (01) data from 80H to 00H, and measure phase change amount ΔH<sub>SFT-</sub> of #39 (H-OUT) waveform.</li> <li>Change slave address (01) data from 80H to FEH, and measure phase change amount ΔH<sub>SFT+</sub> of #39 (H-OUT) waveform.</li> </ol> 

Note	Characteristics	Test Conditions
HA07	Curve correction amount	<ol style="list-style-type: none"> <li>Set subaddress (00) data to 40H.</li> <li>Input signal B (as shown in the figure below) to TP50.</li> <li>Connect external voltage to #40 (curve correction), and measure phase change amount (<math>\Delta H\#40</math>) of #37 (H-OUT) output waveform at 1.5 V and 3.5 V.</li> </ol> 
HA08	Clamp pulse phase, width and level	<ol style="list-style-type: none"> <li>Set subaddress (00) data to 40H.</li> <li>Input signal B (as shown in the figure below) to TP50.</li> <li>Measure #47 (SCP output) clamp pulse phase (<math>CP_{S0}</math>), width (<math>CP_{W0}</math>), and output level (<math>CP_{V0}</math>) in relation to signal B.</li> <li>Set subaddress (01) data to 81H, and repeat the step 3 above to measure (<math>CP_{S1}</math>), (<math>CP_{W1}</math>), and (<math>CP_{V1}</math>).</li> <li>Apply no signal input to TP50.</li> <li>Measure #47 clamp pulse phase (<math>CP_{S2}</math>), width (<math>CP_{W2}</math>), and output level (<math>CP_{V2}</math>) in relation to #39.</li> </ol> 

Note	Characteristics	Test Conditions
HA09	Black peak detection pulse phase and level	<ol style="list-style-type: none"> <li>Set subaddress (00) data to 40H.</li> <li>Set SW70 to C, SW68 to C, and SW39A to OPEN.</li> <li>Input signal C (as the figure shown below) to #39 (FBP input).</li> <li>Measure #70 (BPH filter) black peak detection pulse phase (HBP<sub>S00a</sub> and HBP<sub>S00b</sub>) in relation to signal C.</li> <li>Set HBP-PHS 1/2 to (01), (10), and (11). Measure black peak detection pulse phase.</li> </ol> 
HA10	FBP input threshold	<ol style="list-style-type: none"> <li>Set subaddress (00) data to 40H.</li> <li>Input signal B (as shown in the figure below) to TP50.</li> <li>Increase amplitude of FBP signal to be input to #39 (FBP input) from 0 Vp-p. When #37 (H-OUT) phase locks with that of signal B, measure #39 input amplitude V<sub>thFBP</sub>.</li> </ol> 

Note	Characteristics	Test Conditions
HB01	H-OUT pulse duty	<ol style="list-style-type: none"> <li>No signal input.</li> <li>Measure T1 and T2 (as shown in the figure below) from #37 (H-OUT) output waveform when subaddress (00) data is 80H and A0H. Calculate duties (TH<sub>A</sub> and TH<sub>B</sub>) using the following equation:  <math display="block">TH = T1/(T1 + T2) \times 100 \%</math> </li> </ol>  <p>#37 waveform</p>
HB02	Horizontal free-run frequency	<ol style="list-style-type: none"> <li>Set SW44 to open.</li> <li>Set subaddress (00) data to 01H and measure horizontal free-run frequency (F15K) according to #37 (H-OUT) output waveform.</li> <li>Set subaddress (00) data to 00H, 41H, 81H, C0H, and C1H. Measure horizontal free-run frequency F28K, F31K, F33K, F37K, and F45K as in the step 2 above.</li> </ol>
HB03	Horizontal oscillation frequency variable range	<ol style="list-style-type: none"> <li>Set subaddress (00) data to 01H.</li> <li>Connect 10-kΩ resistor between #44 and V<sub>CC</sub>. Measure horizontal frequency (F15K<sub>MIN</sub>) according to #37 (H-OUT) output waveform.</li> <li>Connect 68-kΩ resistor between #44 and GND. Measure horizontal frequency (F15K<sub>MAX</sub>) according to #37 (H-OUT) output waveform.</li> <li>Set subaddress (00) data to 00H, 41H, 81H, C0H, and C1H. Repeat the steps 2 and 3 above and measure horizontal frequencies F28K<sub>MIN</sub>, F28K<sub>MAX</sub>, F31K<sub>MIN</sub>, F31K<sub>MAX</sub>, F33K<sub>MIN</sub>, F33K<sub>MAX</sub>, F37K<sub>MIN</sub>, F37K<sub>MAX</sub>, F45K<sub>MIN</sub>, and F45K<sub>MAX</sub>.</li> </ol>
HB04	Horizontal oscillation control sensitivity	<ol style="list-style-type: none"> <li>Set SW44 to open.</li> <li>Connect external power supply to TP44, and set subaddress (00) data to 01H.</li> <li>Apply V<sub>44</sub> + 0.05 V, and V<sub>44</sub> - 0.05 V to TP44. Measure frequencies FA and FB according to #37 (H-OUT) output waveform. Calculate frequency change rate (BH15K) using the following equation.  <math display="block">BH15K = (FB - FA)/0.1</math> </li> <li>Set subaddress (00) data to 00H, 41H, 81H, C0H, and C1H. Repeat the step 2 above, and measure frequency change rate BH28K, BH31K, BH33K, BH37K, and BH45K</li> </ol>
HB05	H-OUT output voltage	<ol style="list-style-type: none"> <li>Set SW37 to open.</li> <li>Measure voltage at High (V37<sub>H</sub>) and Low (V37<sub>L</sub>) of #37 (H-OUT) output waveform.</li> </ol>

Note	Characteristics	Test Conditions
V01	VP output pulse width, Vertical free-run (maximum pull-in range)	<ol style="list-style-type: none"> <li>Input signal D (shown in the figure below) to TP50, and signal E (shown in the figure below) to #39 (FBP input).</li> <li>Measure VP output pulse width (VPw) according to TP35 output waveform.</li> <li>Measure VP pull-in range (VPt0) according to TP35 output waveform.</li> <li>Set subaddress (03) data to 01H, 02H, 03H, 04H, 05H, and 06H. Measure pull-in range VPt1, VPt2, VPt3, VPt4, VPt5, and VPt6 as in the step 3 above.</li> </ol> 
V02	Vertical minimum pull-in range	<ol style="list-style-type: none"> <li>Repeat the step 1 of Note #V01.</li> <li>Input signal F (shown in the figure below) to TP52.</li> <li>Increase signal-F cycle from 30 H. Measure the cycle (<math>T_{VPULL}</math>) when phase locks with that of TP35.</li> </ol> 

Note	Characteristics	Test Conditions
V03	Vertical black peak detection pulse	<p>1. Repeat the step 1 of Note #V01. Set SW70 to C, and SW68 to C.</p> <p>2. Input signal F (shown in the figure below) to TP52.</p> <p>3. Measure phase differences <math>VBPP_{0E}</math> and <math>VBPP_{0S}</math> according to #47 output waveform.</p> <p>4. Set subaddress (03) data to 01H, 02H, 03H, 04H, 05H, and 06H. Measure phase differences <math>VBPP_{1E}</math>, <math>VBPP_{1S}</math>, <math>VBPP_{2E}</math>, <math>VBPP_{2S}</math>, <math>VBPP_{3E}</math>, <math>VBPP_{3S}</math>, <math>VBPP_{4E}</math>, <math>VBPP_{4S}</math>, <math>VBPP_{5E}</math>, <math>VBPP_{5S}</math>, <math>VBPP_{6E}</math>, and <math>VBPP_{6S}</math> as in the step 3 above.</p> 
V04	Vertical blanking stop phase	<p>1. Repeat the step 1 of Note #V01.</p> <p>2. Input signal F (shown in the figure below) to TP52.</p> <p>3. Set subaddress (03) data to 00H and F0H. Measure blanking stop phase <math>VBLK_{MIN}</math> and <math>VBLK_{MAX}</math> according to #12 output waveform.</p> 

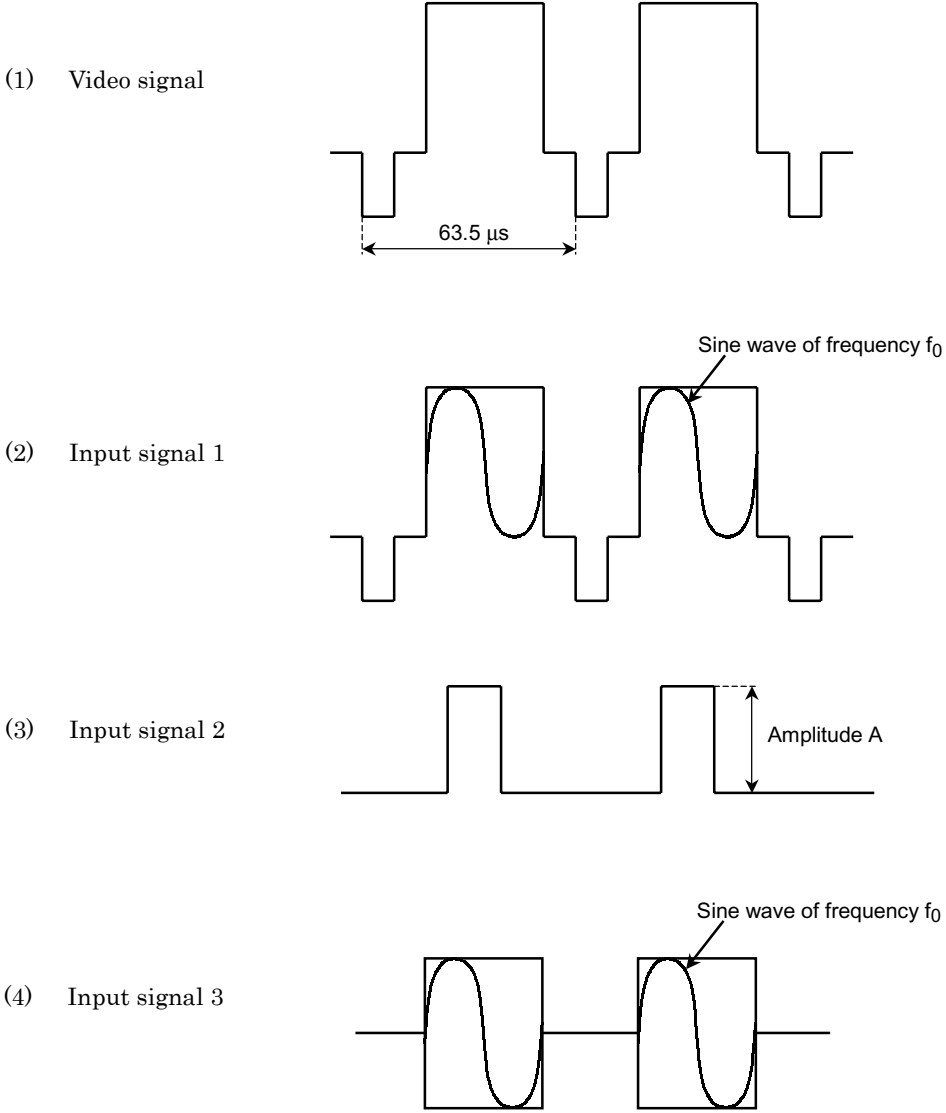
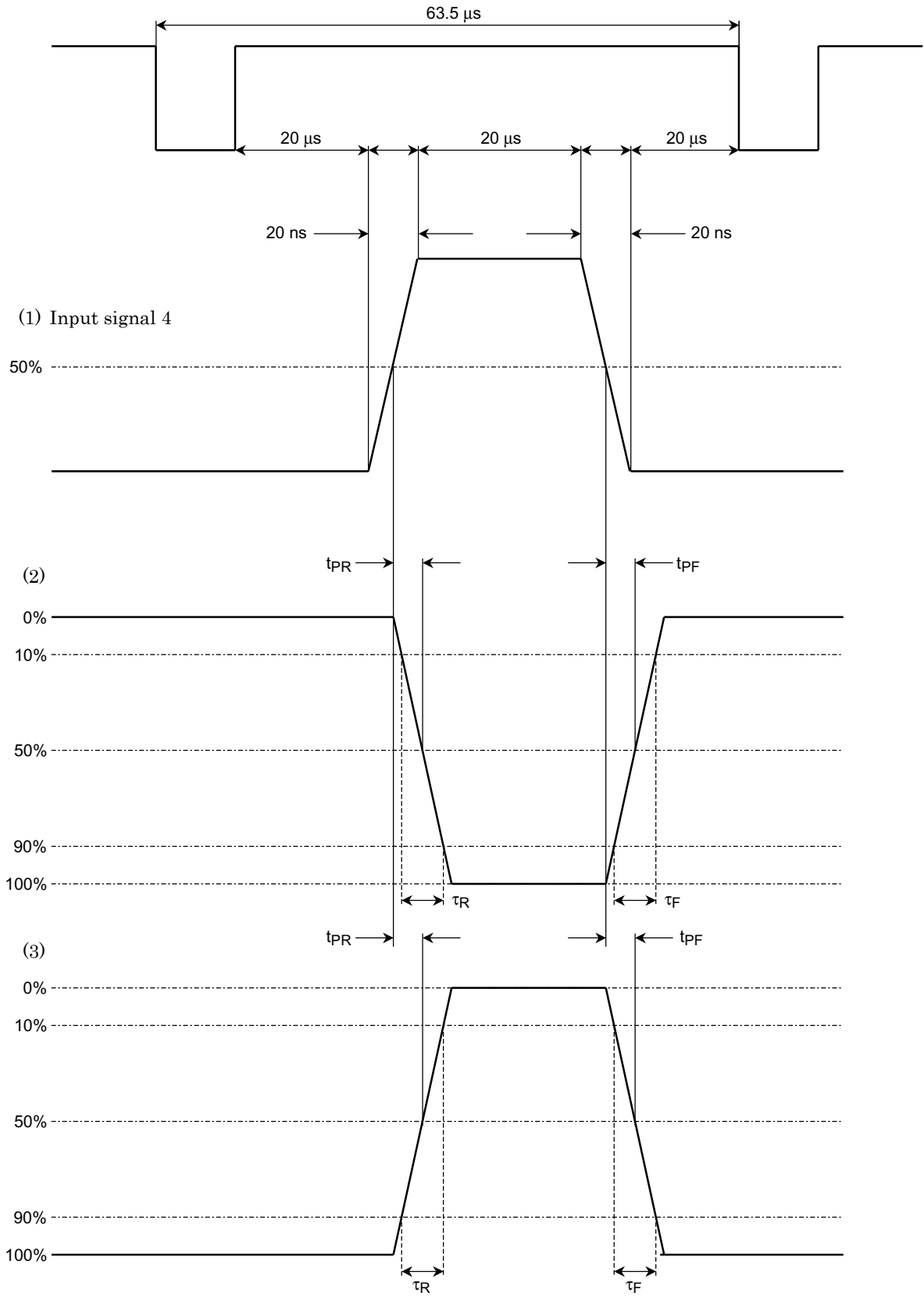


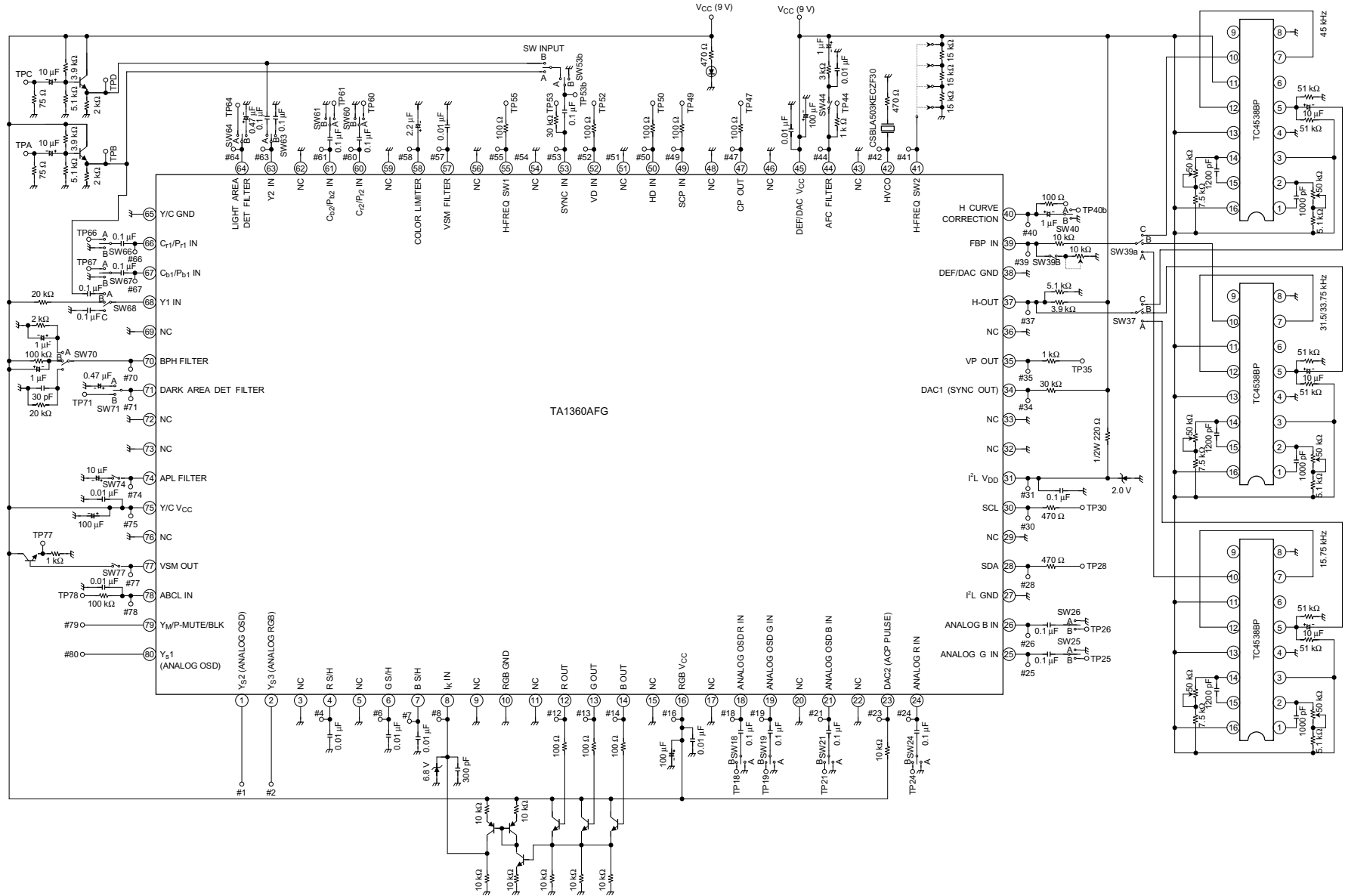
Figure T-1 Signals for Text/Color Difference Signal 2



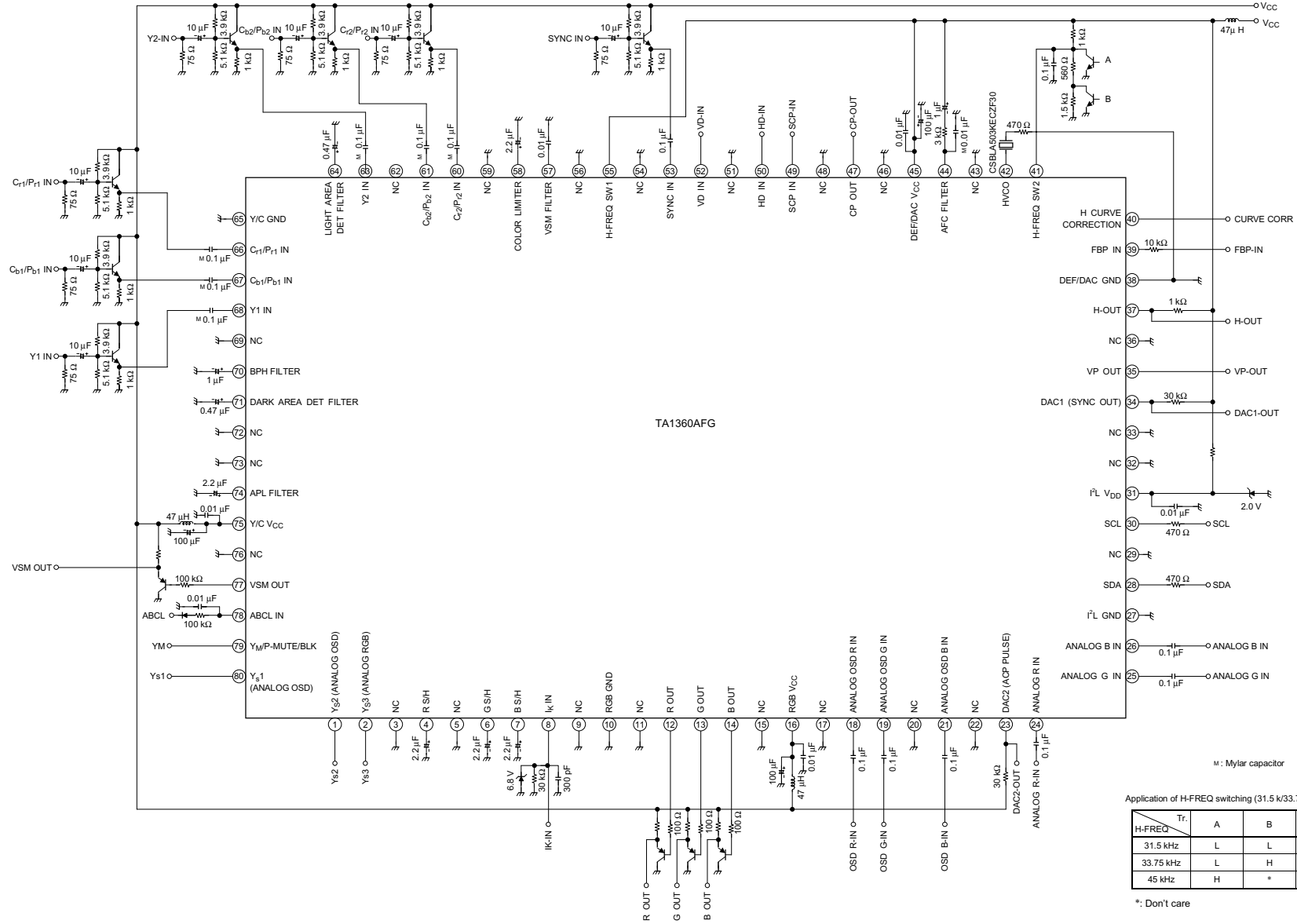


**Figure T-2 Test Pulses for Text/Color Difference Signal 2**

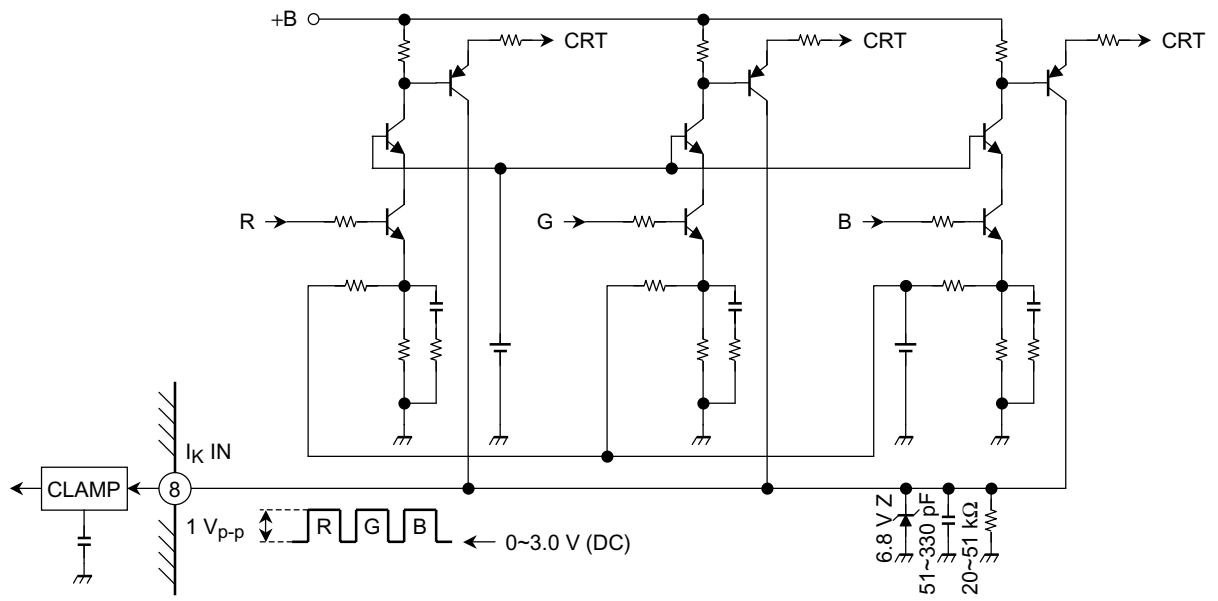
Test Circuit



Application Circuit



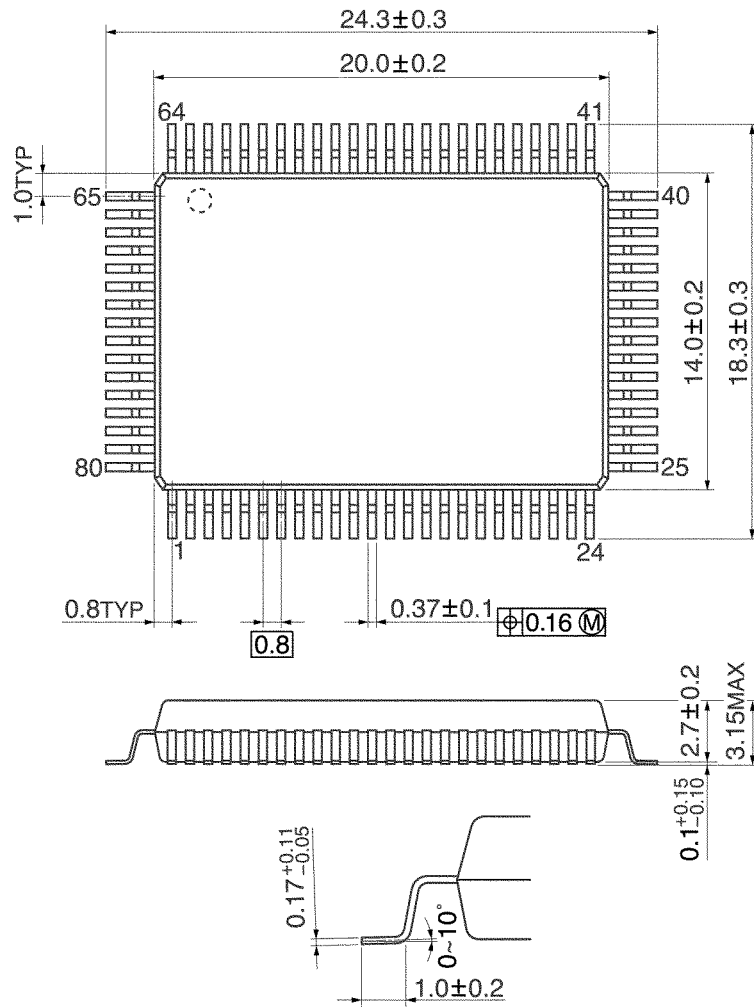
**ACB Application Circuit**



**Package Dimensions**

QFP80-P-1420-0.80F

Unit: mm



Weight: 1.6 g (typ.)

**RESTRICTIONS ON PRODUCT USE**

000707EBA

- TOSHIBA is continually working to improve the quality and reliability of its products. Nevertheless, semiconductor devices in general can malfunction or fail due to their inherent electrical sensitivity and vulnerability to physical stress. It is the responsibility of the buyer, when utilizing TOSHIBA products, to comply with the standards of safety in making a safe design for the entire system, and to avoid situations in which a malfunction or failure of such TOSHIBA products could cause loss of human life, bodily injury or damage to property.  
In developing your designs, please ensure that TOSHIBA products are used within specified operating ranges as set forth in the most recent TOSHIBA products specifications. Also, please keep in mind the precautions and conditions set forth in the "Handling Guide for Semiconductor Devices," or "TOSHIBA Semiconductor Reliability Handbook" etc..
- The TOSHIBA products listed in this document are intended for usage in general electronics applications (computer, personal equipment, office equipment, measuring equipment, industrial robotics, domestic appliances, etc.). These TOSHIBA products are neither intended nor warranted for usage in equipment that requires extraordinarily high quality and/or reliability or a malfunction or failure of which may cause loss of human life or bodily injury ("Unintended Usage"). Unintended Usage include atomic energy control instruments, airplane or spaceship instruments, transportation instruments, traffic signal instruments, combustion control instruments, medical instruments, all types of safety devices, etc.. Unintended Usage of TOSHIBA products listed in this document shall be made at the customer's own risk.
- The products described in this document are subject to the foreign exchange and foreign trade laws.
- The information contained herein is presented only as a guide for the applications of our products. No responsibility is assumed by TOSHIBA CORPORATION for any infringements of intellectual property or other rights of the third parties which may result from its use. No license is granted by implication or otherwise under any intellectual property or other rights of TOSHIBA CORPORATION or others.
- The information contained herein is subject to change without notice.