

TOSHIBA Bipolar Linear Integrated Circuit Silicon Monolithic

TA2022AFNG

1.5V AM/FM IF + MPX

TA2022AFNG is the AM / FM IF + MPX system IC, which is developed for headphone radio in 1.5V use.

This is included many functions and this can be used for digital tuning system with IF counter.

Features

- Suitable for combination with digital tuning system which is included IF counter.
- Built-in AM / FM IF count output for IF counter of digital tuning system.
 - FM: 10.7MHz
 - AM: 450kHz
- Adjustable for stop pulse sensitivity (in FM mode)
- For adopting ceramic discriminator, it is not necessary to adjust the FM QUAD detector circuit.
- Built-in AM IF output for AM stereo
- MPX input for main signal is independent of that for pilot signal. (MPX input for pilot signal is shared with AM input)
- MPX output is high-impedance in power off mode.
- Built-in power switch
- Low supply current ($V_{CC} = 1.2V$, $T_a = 25^\circ C$)
 - FM mode: $I_{CC2} = 5.5mA$ (typ.)
 - AM mode: $I_{CC3} = 3.7mA$ (typ.)
- Operating supply voltage range ($T_a = 25^\circ C$)
 - $V_{CC (opr)} = 0.95\sim 2.2V$
- Stereo operating supply voltage range ($T_a = 25^\circ C$)
 - $V_{CC (opr)} = 1.0\sim 2.2V$

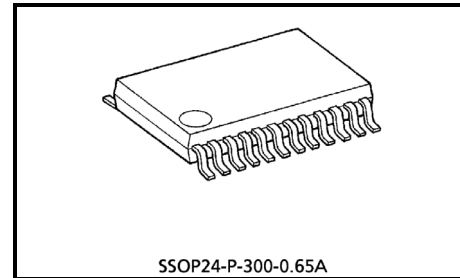

Weight: 0.14 g (typ.)

BLOCK DIAGRAM

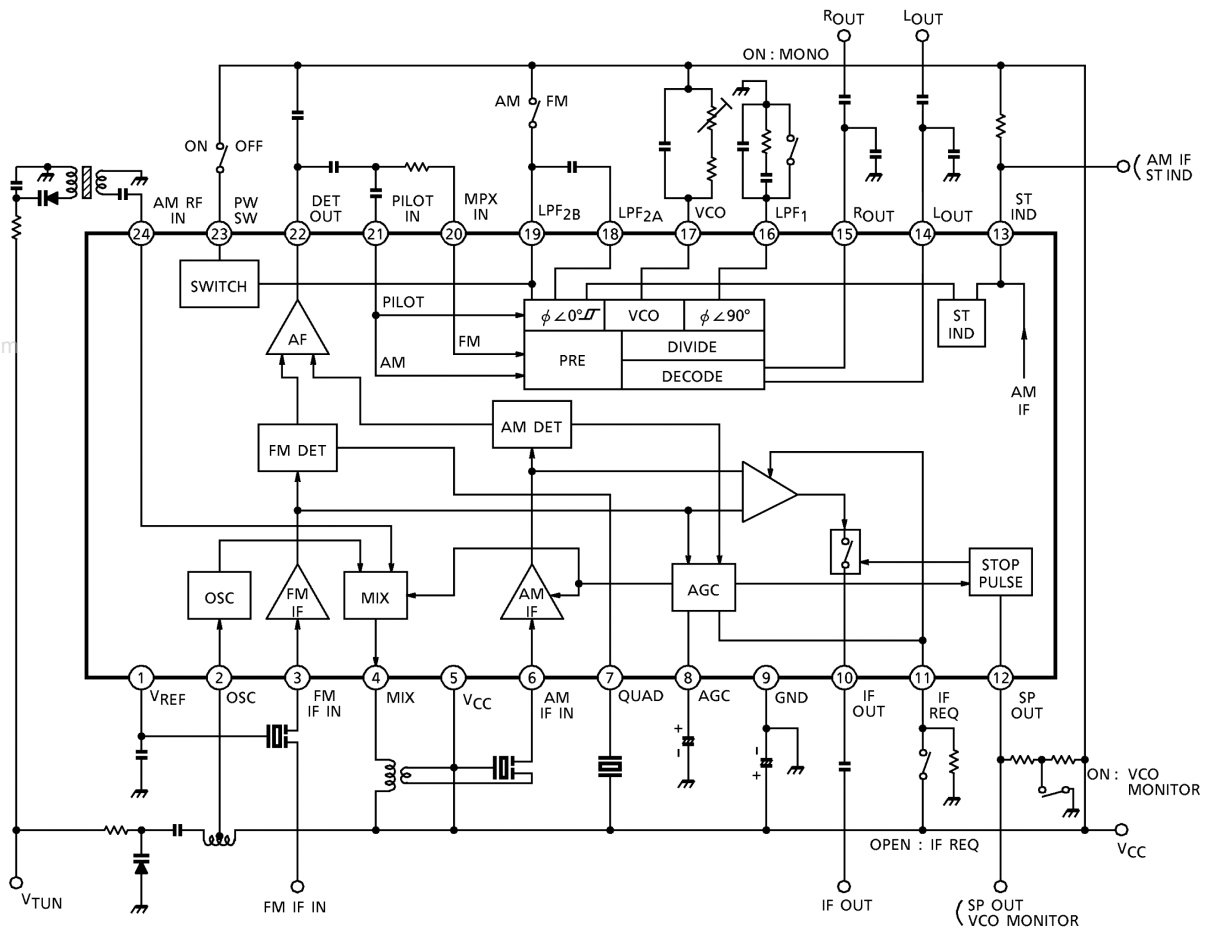

Terminal Explanation

Terminal Voltage: Typical Terminal Voltage at no Signal with The Test Circuit 1

($V_{CC} = 1.2V$, $T_a = 25^\circ C$)

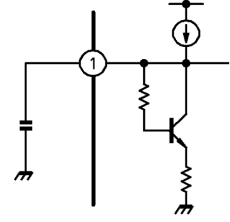
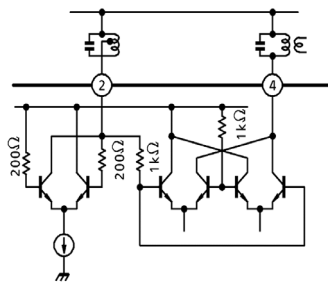
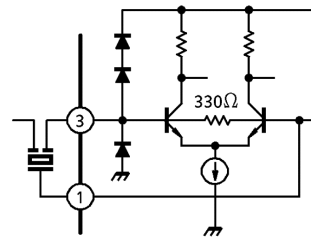
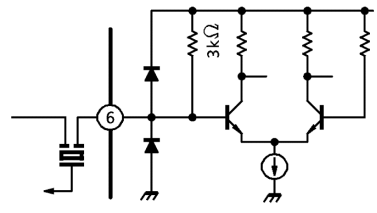
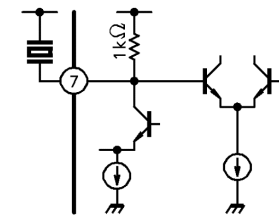
Terminal		Function	Internal Circuit	Terminal Voltage (V)	
No.	Name			AM	FM
1	V _{REF}	Referential voltage Bypass terminal for AM RF and FM IF amplifier		0.9	0.9
2	OSC	AM OSC		1.2	1.2
4	MIX	Output of AM MIX		1.2	1.2
3	FM IF in	Input of FM IF signal • Input impedance 330Ω (typ.)		0.9	0.9
5	V _{CC}	—	—	1.2	1.2
6	AM IF IN	Input of AM IF signal • Input impedance 3kΩ (typ.)		1.2	1.2
7	QUAD	FM QUAD detector		1.2	1.2

www.DataSheet4U.com

Terminal		Function	Internal Circuit	Terminal Voltage (V)	
No.	Name			AM	FM
8	AGC	<ul style="list-style-type: none"> AM mode AGC time constant is determined by external capacitor. FM mode The sudden change of stop pulse sensitivity is held in by external capacitor. 		—	—
9	GND	—	—	0	0
10	IF OUT	Output of IF count signal In case of IF request mode, IF count signal for IF counter is taken from this terminal. FM: $V_{IF (FM)} = 80mV_{p-p}$ (typ.) AM: $V_{IF (AM)} = 100mV_{p-p}$ (typ.)		—	—
11	IF REQ	IF request switch V_{CC} : Receive mode Open: IF request mode FM stop pulse sensitivity can be changed by connecting R_{SEN} in IF request mode. R_{SEN} should be smaller than 100kΩ		—	—
12	SP OUT	Output of stop pulse VCO frequency can be monitored, in case that this terminal is connected with GND through a resistor ($R_{VCO} \approx 100k\Omega$). ON : VCO monitor OPEN : SP OUT		—	—
13	ST IND	Stereo indicator terminal <ul style="list-style-type: none"> This terminal shared with output of modulated AM IF signal. AM IF output: $6mV_{rms}$ ($R_{IF} = 3k\Omega$, typ.) R_{IF} should be smaller than 3kΩ. In case that $R_{IF} > 3k\Omega$, internal biasing circuit doesn't operate normally in AM mode. 		—	—

www.DataSheet4U.com

Terminal		Function	Internal Circuit	Terminal Voltage (V)	
No.	Name			AM	FM
14	LOUT	Output of stereo signal These terminals are high-impedance in power off mode.		0.5	0.5
15	ROUT				
16	LPF ₁	LPF terminal for phase detector		—	—
17	VCO	VCO The temperature characteristic of free running frequency is +350ppm / °C. Temperature coefficient: SH		—	1.2
18	LPF _{2A}	LPF terminal for synchronous detector		—	—
19	LPF _{2B}	LPF terminal for synchronous detector and AM / FM switch V _{CC} : AM mode OPEN: FM mode		1.2	—
21	PILOT IN	Input of FM stereo pilot signal and AM signal		0.1	0.1

Terminal		Function	Internal Circuit	Terminal Voltage (V)	
No.	Name			AM	FM
20	MPX IN	Input of FM stereo main signal		—	0.1
22	DET OUT	Detector output circuit • Output impedance (typ.) AM: 10kΩ FM: 1kΩ		0.6	0.6
23	PW SW	Power switch V _{CC} : IC on OPEN/GND: IC off		1.2	1.2
24	AM RF IN	Input of AM RF signal • Input impedance: 13kΩ (typ., at no signal)		0.9	0

Application Note

1. Power switch

It is necessary to connect an external pull-down resistor with the terminal of PW SW (pin (23)), in case that this IC is turned on due to external noise etc.

2. Mode switch

The terminal of AM / FM changeover is pin(19).

In controlling the AM / FM mode with voltage, it is applied as follows.

VCC : AM mode

OPEN: FM mode

In FM mode, care should be taken to eliminate influence due to external noise etc, because this terminal is opened.

The leak current flows through this terminal, in the case that the terminal is connected to VCC line independently, even through this IC is off mode (the terminal of PW SW (pin(23)) is off mode).

www.DataSheet4U.com

3. IF count output

IF count signal can be taken from IF output terminal (pin(10)), when IF request terminal (pin(11)) is connected with GND through R_{SEN} and stop pulse sensitivity is on.

	Switch Condition		Output Frequency	Output Voltage (typ.)	Output Impedance (typ.)
	Pin(11)	Pin(19)			
FM	OPEN	OPEN	10.7MHz	80mV _{p-p}	2 kΩ
AM	(R _{SEN} ≤ 100kΩ)	VCC	450kHz	100mV _{p-p}	

Table.1 IF count output

4. FM stop pulse sensitivity

FM stop pulse sensitivity can be changed by connecting an external resistor R_{SEN} between IF request terminal (pin(11)) and GND. The gain of FM IF amplifier is controlled by R_{SEN}, and FM stop pulse sensitivity is changed.

It is advised that R_{SEN} is 100kΩ or less.

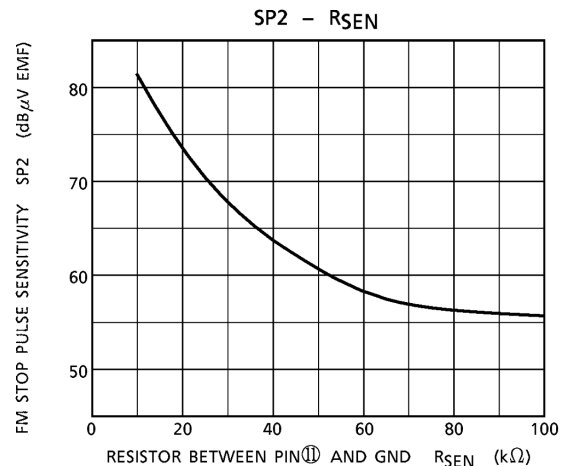

Fig.1 SP2 - R_{SEN}

5. MPX IN

This IC can attenuate only FM stereo main signal level. Because MPX input for main signal (pin(20)) is independent of that for pilot signal (pin(21), this terminal is shared with AM input). Internal circuit of MPX in terminal (pin(20)) is shown in fig.2. FM stereo main signal level can be attenuated by connecting an external resistor R_X . Because FM stereo main signal level is attenuated by internal resistor ($14k\Omega$ and $10k\Omega$) and resistor R_X . And it is applied to an emitter of transistor Q.

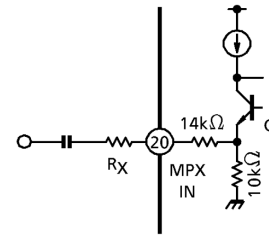

Fig.2 Internal circuit of MPX IN terminal

6. AM tweets

It is necessary to connect the capacitor C_t (about $330pF$) between V_{CC} terminal (pin(6)) and DET OUT (pin(22)), in case that AM tweets occurs by pattern layout. (Fig.3) This C_t can also functions as phase compensation of MPX stage.

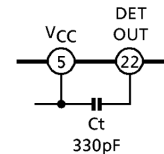

Fig.3 Countermeasures for AM tweets

7. AM AGC

It is necessary to connect a capacitor C (about $68pF$) between V_{CC} terminal (pin(8)) and AM IF IN terminal (pin(6)), in case that AGC circuit doesn't operate normally. Because second harmonic of local oscillator is applied AM IF terminal (pin(6)) by pattern layout.

In case that capacitor ($C = 68pF$) is connected, AM stop pulse sensitivity is delayed about 1dB. Output DC voltage of AGC terminal (pin(8)) is $V_8 = 0.1V$ (typ., AM mode, at no signal).

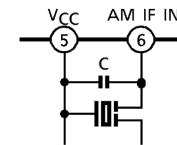

Fig.4 AM trap circuit

8. Stereo indicator / AM IF output (for AM stereo)

- The terminal of pin(13) is built in stereo indicator function and modulated AM IF signal output. In AM mode, R_{IF} ($3k\Omega$ or less) should be connected between V_{CC} and pin(13), or pin(13) should be connected to V_{CC} directly. (Fig.5) In case that $R_{IF} > 3k\Omega$ or pin (13) is opened, this IC doesn't operate normally in AM mode. Because transistor Q_2 is saturated.

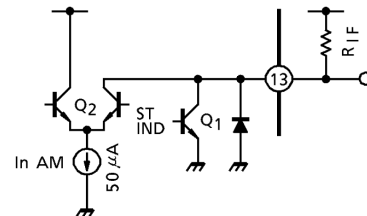

Fig.5 Internal circuit of pin⑬

- AM IF output
 $V_{IF} (AM\ MOD) = 6mV_{rms}$ (typ. $R_{IF} = 3k\Omega$)
 The applications of this terminal are explained as follow.

(a) Method to use stereo indicator and AM IF output
 External circuit is recommended as shown in fig.6.

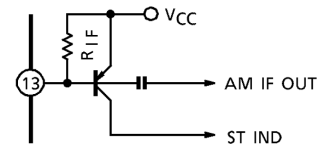

Fig.6 Method to use stereo indicator and AM IF output.

(b) Method to use stereo indicator.
 External circuit is recommended as shown in fig.7.
 R_{IF} is not needed in case that this IC is not use in AM mode.

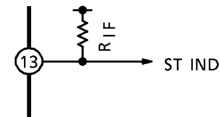

Fig.7 Method to use stereo indicator.

(c) Method to use AM IF output
 External circuit is recommended as shown in fig.8.

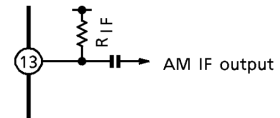

Fig.8 Method to use AM IF output.

(d) In case that functions of this terminal are not used.
 External circuit is recommended as shown in fig.9.
 R_{IF} is not needed in case that this IC is not used in AM mode.

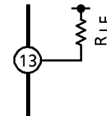

Fig.9 In case that functions of this terminal are not used.

Absolute Maximum Ratings (Ta = 25°C)

Characteristic	Symbol	Rating	Unit
Supply voltage	V_{CC}	4.5	V
Stop pulse voltage	V_{SP}	4.5	V
Stop pulse current	I_{SP}	10	mA
Stereo indicator voltage	V_{ST}	4.5	V
Stereo indicator current	I_{ST}	10	mA
Power dissipation	P_D (Note)	500	mW
Operating temperature	T_{opr}	-25~75	°C
Storage temperature	T_{stg}	-55~150	°C

Note: Derated above $T_a = 25^\circ C$ in the proportion of $4mW / ^\circ C$.

Electrical Characteristics

Unless Otherwise Specified

$V_{CC} = 1.2V$, $T_a = 25^\circ C$, SW1: a, SW4: OPEN, SW5: a, SW6: a / b, SW7: ON
 FM IF: $f = 10.7MHz$, $f_m = 1kHz$, $\Delta f = \pm 22.5kHz$, $V_{in} = 80dB\mu V$, EMF, SW2: ON, SW3: b
 AM: $f = 1MHz$, $f_m = 1kHz$, MOD = 30%, $V_{in} = 60dB\mu V$, EMF, SW2: OPEN, SW3: a
 MPX: $f_m = 1kHz$, $f_p = 19kHz$, SW3:b

Characteristic		Symbol	Test Circuit	Test Condition	Min.	Typ.	Max.	Unit	
Supply current		I_{CC1}	1	PW off, SW1: b	—	—	5	μA	
		I_{CC2}		FM mode, $V_{in} = 0$	—	5.5	7.5	mA	
		I_{CC3}		AM mode, $V_{in} = 0$	—	3.7	5.5		
FM IF	Input limiting sensitivity	$V_{in(lim)}$	1	-3dB limiting	43	48	53	$dB\mu V$ EMF	
	Recovered output voltage 1	V_{OD1}			35	55	70	mV_{rms}	
	Signal to noise ratio 1	S / N1			—	60	—	dB	
	Total harmonic distortion 1	THD1			—	0.5	—	%	
	AM rejection ratio	AMR		MOD = 30%	—	40	—	dB	
	Stop pulse sensitivity 1	SP1		$I_{12} = 0.5mA$, SW6: a	50	55	60	$dB\mu V$ EMF	
	Stop pulse sensitivity 2	SP2		$I_{12} = 0.5mA$, $R_{SEN} = 39k\Omega$ SW6: a, SW7: OPEN	—	64	—		
	IF output voltage	$V_{IF(FM)}$		$\Delta f = 0$, SW7: OPEN	—	80	—	mV_{p-p}	
AM	Gain	G_V	1	$V_{in} = 26dB\mu V$ EMF	15	27	—	mV_{rms}	
	Recovered output voltage 2	V_{OD2}			30	45	60		
	Signal to noise ratio2	S / N2			—	38	—	dB	
	Total harmonic distortion 2	THD2			—	1.5	—	%	
	Stop pulse sensitivity	SP3		$I_{12} = 0.5mA$, SW6: a	25	30	35	$dB\mu V$ EMF	
	IF output voltage	$V_{IF(AM)}$		MOD = 0, SW7: OPEN	—	100	—	mV_{p-p}	
	Oscillator voltage	V_{osc}		2		30	55	—	mV_{rms}
	Oscillator stop voltage	V_{stop}				—	—	0.95	V

www.DataSheet4U.com

Characteristic		Symbol	Test Circuit	Test Condition	Min.	Typ.	Max.	Unit		
M P X	Voltage gain 1	G_V (FM)	1	$V_{in} = 100mV_{rms}$ (mono)	-1.5	+0.5	+2.5	dB		
	Voltage gain 2	G_V (AM)			-0.5	+1.5	+3.5			
	Channel balance	CB			-2	—	+2			
	Maximum composite signal input level	V_{in} (MAX)			L + R =90%, P = 10% THD = 3%	—	220	—	mV _{rms}	
	Total harmonic distortion	Mono		THD3	$V_{in} = 100mV_{rms}$ (mono)	—	0.2	0.5	%	
		Stereo		THD4	L + R =90mV _{rms} , P = 10mV _{rms}	—	0.3	—		
		AM		THD5	$V_{in} = 100mV_{rms}$	—	0.2	—		
	Separation	SEP		L + R =90mV _{rms} P = 10mV _{rms}	$f_m = 100Hz$	—	36	—	dB	
					$f_m = 1kHz$	25	35	—		
					$f_m = 10kHz$	—	34	—		
	Stereo indicator sensitivity	On		ST (ON)	Pilot signal input $I_{13} = 0.5mA$, SW5: a	—	5.5	8	mV _{rms}	
		Off		ST (OFF)		2	4	—		
	Stereo indicator hysteresis	V_H		To indicator turn off from turn on	—	1.5	—	mV _{rms}		
Capture range	CR		P = 10mV _{rms} , $f_p = 19kHz$	—	±7	—	%			
Signal noise ratio 3	S / N3		$V_{in} = 100mV_{rms}$ (mono)	—	65	—	dB			
Power switch	On current	I_{23}	2	$V_{CC} = 0.95V$	SW1: c	5	—	—	μA	
	Off voltage	V_{23}			SW1: d	0	—	0.3	V	
AM mode on current	I_{19}	SW3: c			50	—	—	μA		
FM mono mode on voltage	V_{16}	SW4: ON			—	0.1	—	V		
IF request off voltage	V_{11}	SW7: ON			0.9	—	—	V		

www.DataSheet4U.com

TEST CIRCUIT 1

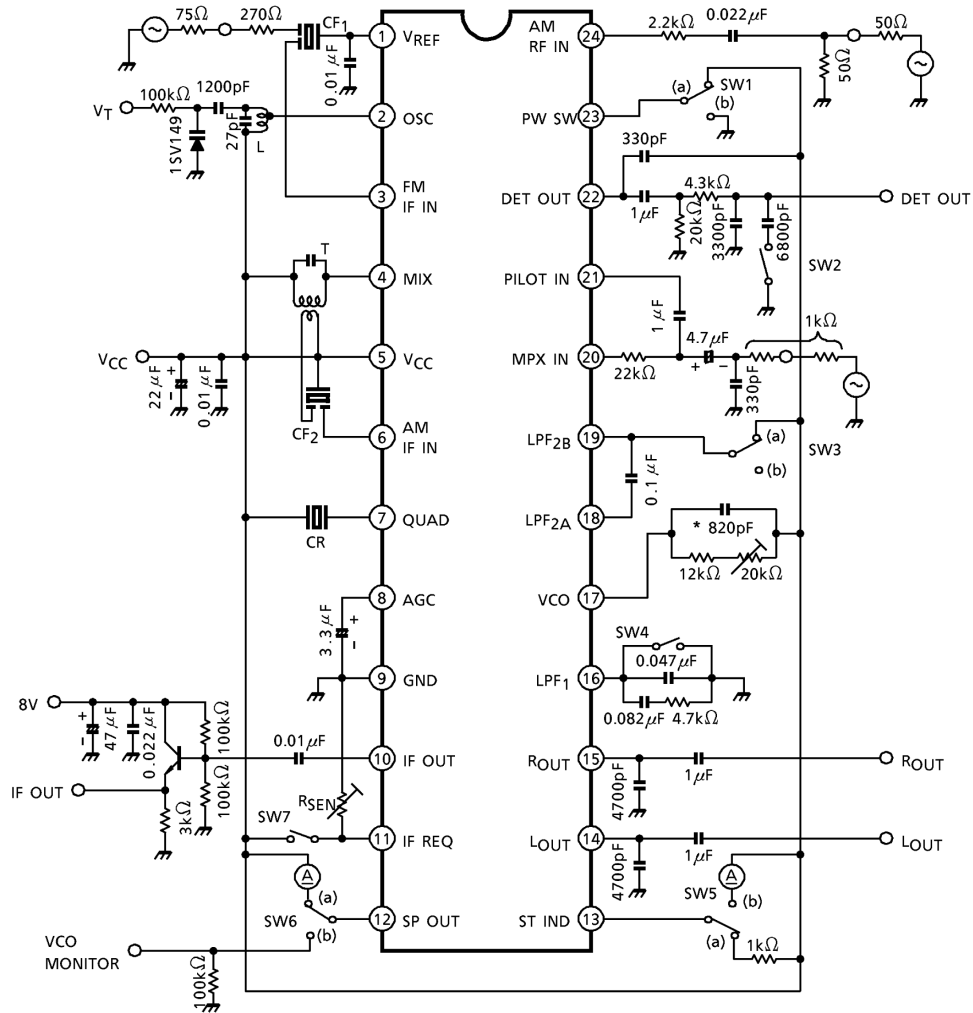

* Temperature coefficient : SH (-330ppm / °C)

CF₁ : SFE10.7MA8 (MURATA Co., Ltd.)

CF₂ : PFA450A (MURATA Co., Ltd.)

CR : CDA10.7MG50 (MURATA Co., Ltd.)

- For measurement of the THD₄, V_{in} (Max.), and SEP the filter shown in Figure 10 is used.

ATT : ATT ≥ 60dB (f = 19 ~ 100kHz)

Filter : 4501-054 (SUMIDA ELECTRIC Co., LTD) with insertion loss of 0.3dB

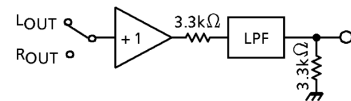
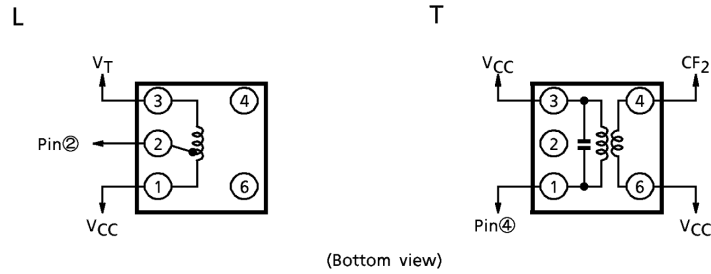

Fig.10 Filter circuit

Coil Data

Coil	Test Frequency	L (μH)	Co (pF)	Qo	Turns				Wire (mmφ)	Reference (coil no.)
					1-2	2-3	1-3	4-6		
L AM OSC	796kHz	100	—	85	13	55	—	—	0.06UEW	(S)4187-144
T AM IFT	450kHz	—	180	65	—	—	184	29	0.05UEW	(S)4161-242

(S): SUMIDA ELECTRIC Co., LTD.



TEST CIRCUIT 2

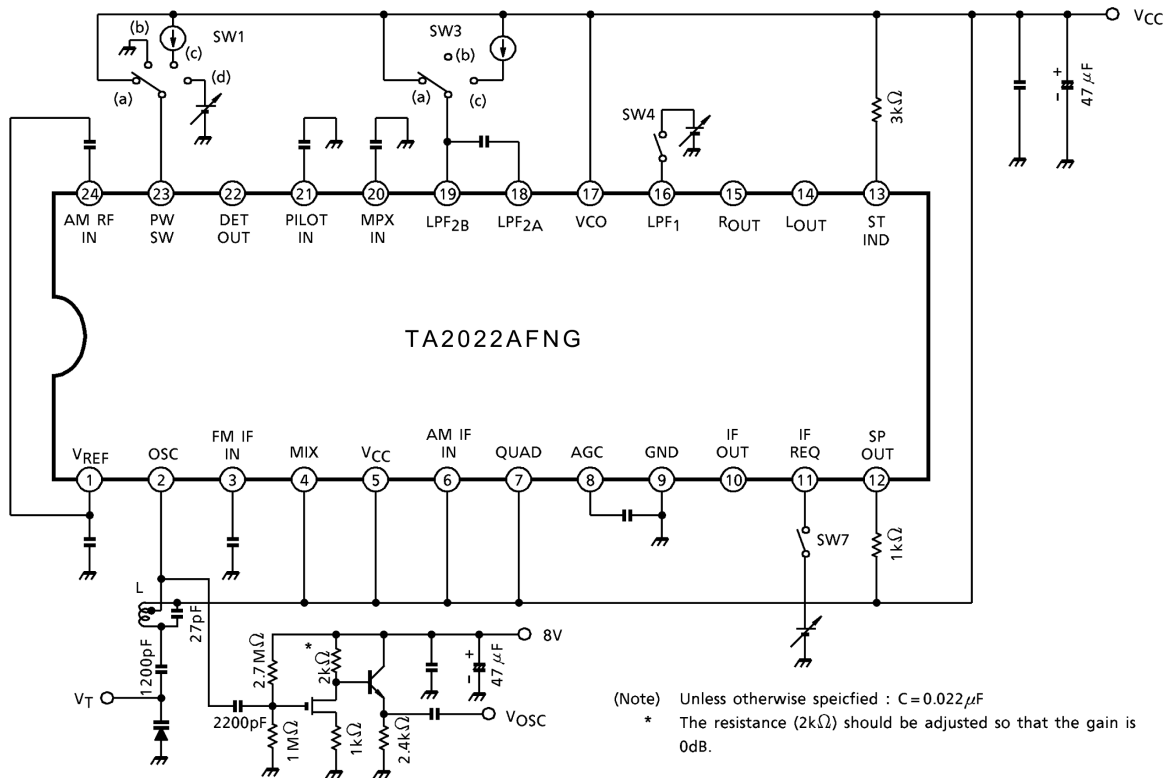

Characteristic Curve

FM IF

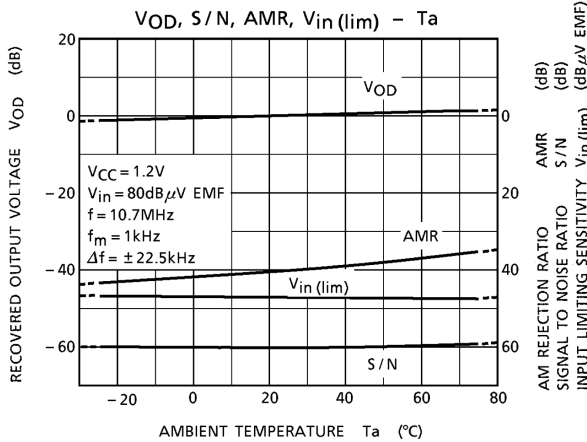
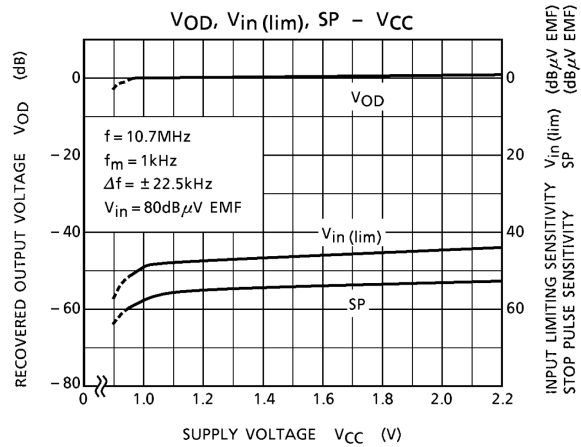
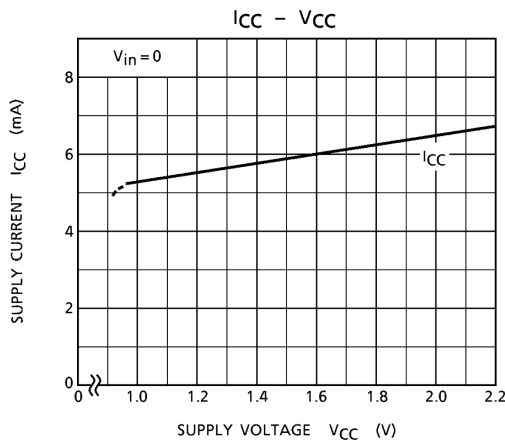
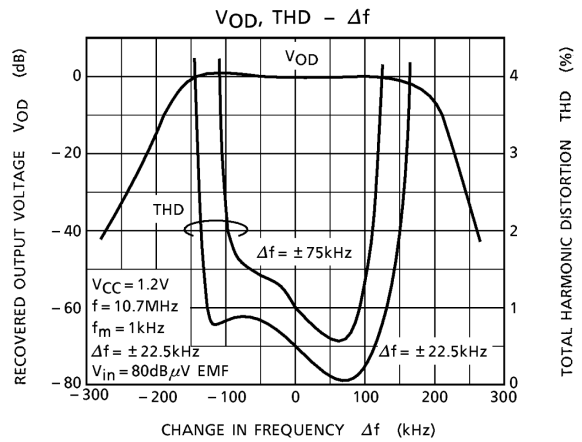
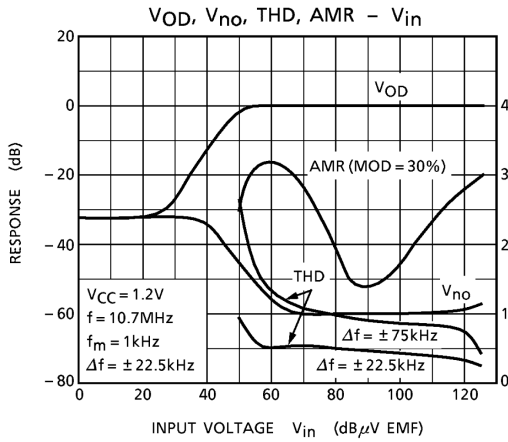

AM

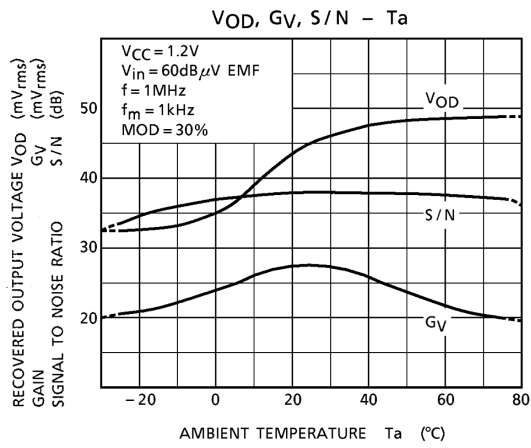
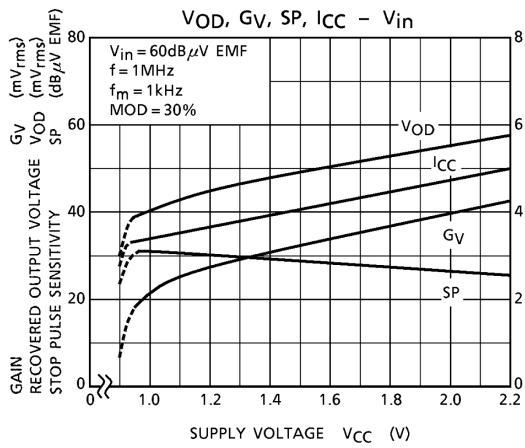
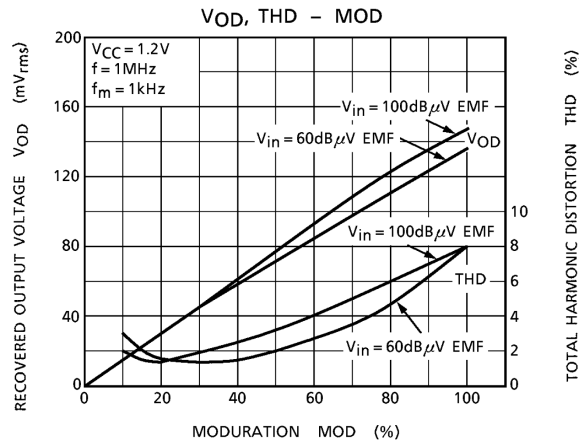
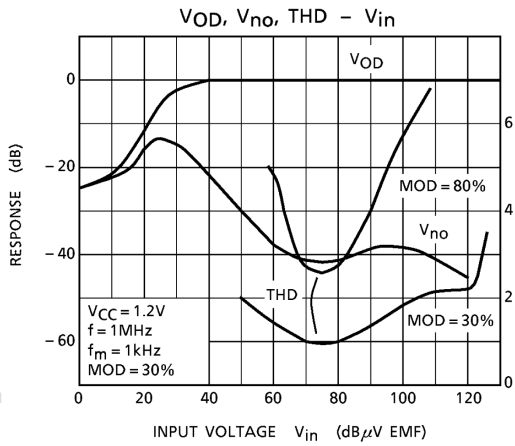

MPX

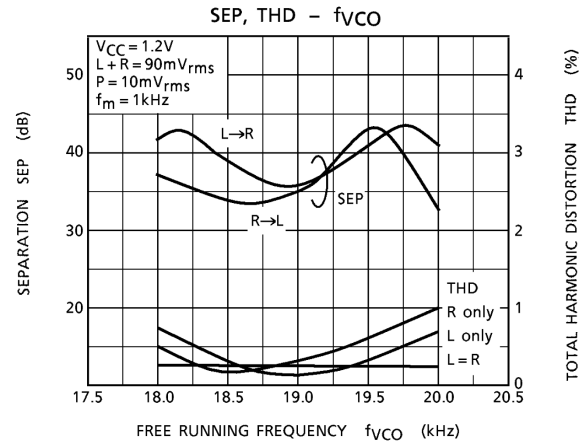
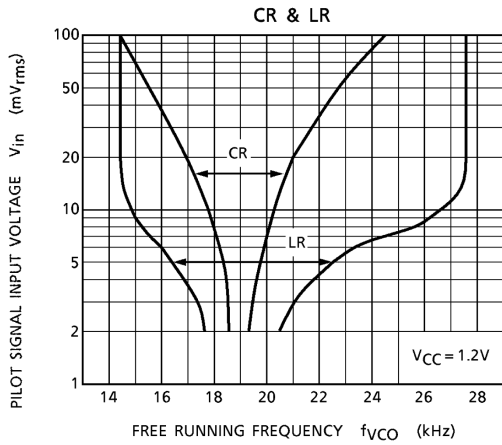

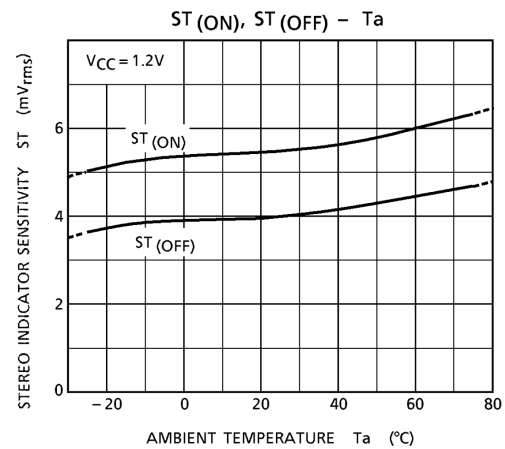
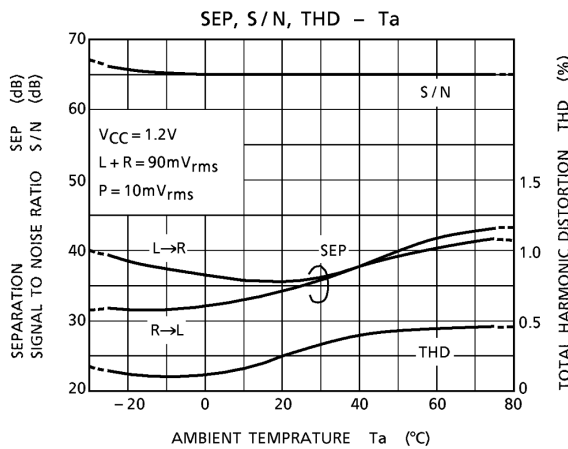
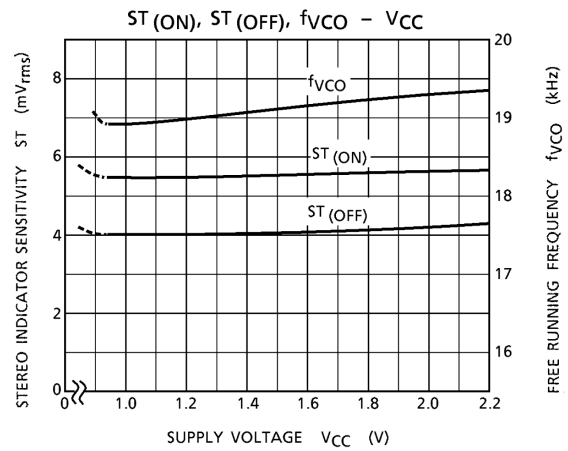
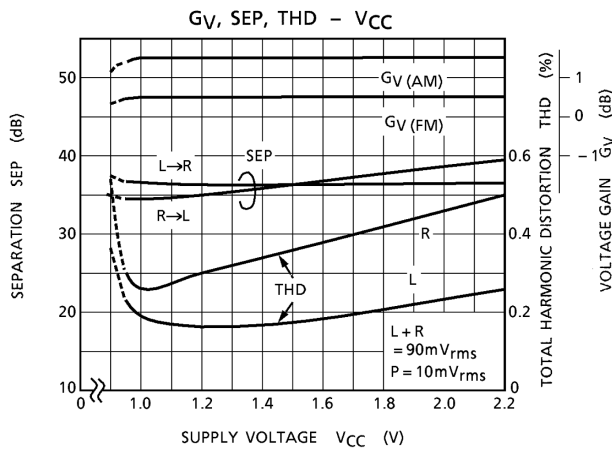
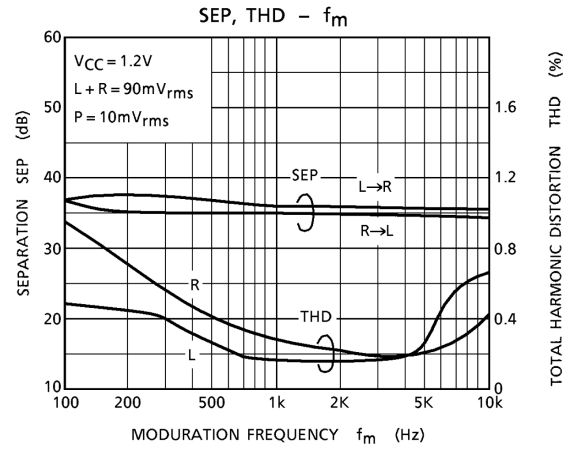
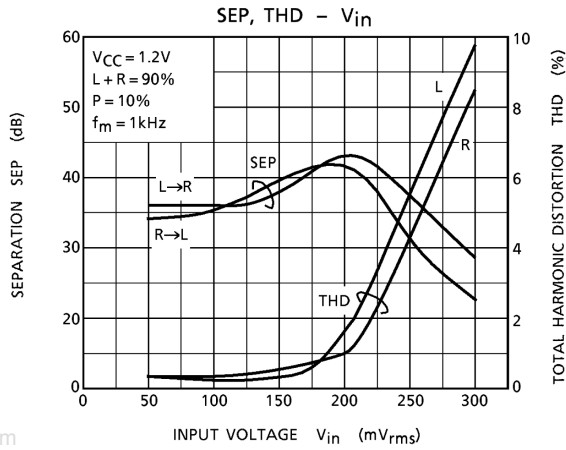

Package Dimensions

SSOP24-P-300-0.65A

Unit : mm

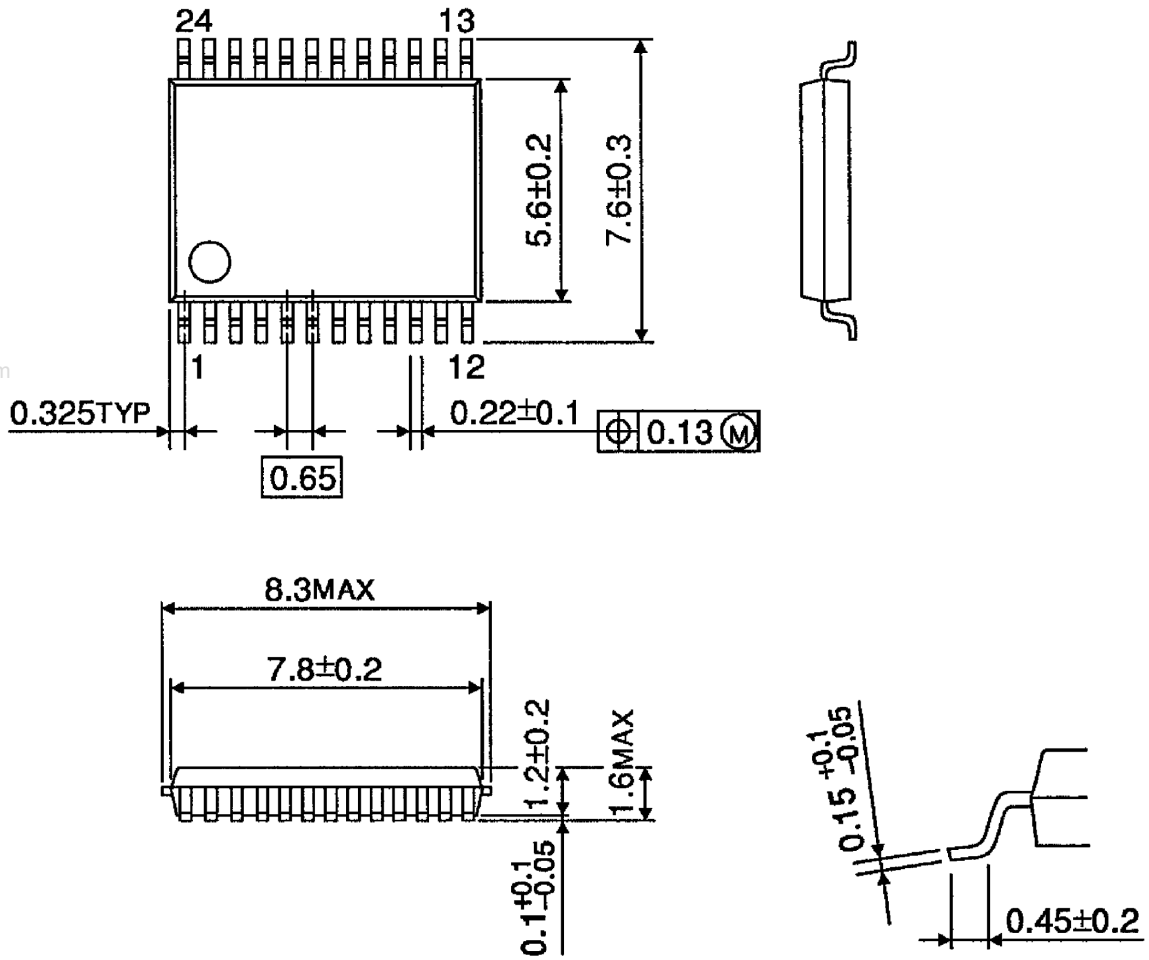

Weight: 0.14g (typ.)

RESTRICTIONS ON PRODUCT USE

060116EBA

- The information contained herein is subject to change without notice. 021023_D
- TOSHIBA is continually working to improve the quality and reliability of its products. Nevertheless, semiconductor devices in general can malfunction or fail due to their inherent electrical sensitivity and vulnerability to physical stress. It is the responsibility of the buyer, when utilizing TOSHIBA products, to comply with the standards of safety in making a safe design for the entire system, and to avoid situations in which a malfunction or failure of such TOSHIBA products could cause loss of human life, bodily injury or damage to property.
In developing your designs, please ensure that TOSHIBA products are used within specified operating ranges as set forth in the most recent TOSHIBA products specifications. Also, please keep in mind the precautions and conditions set forth in the "Handling Guide for Semiconductor Devices," or "TOSHIBA Semiconductor Reliability Handbook" etc. 021023_A
- The TOSHIBA products listed in this document are intended for usage in general electronics applications (computer, personal equipment, office equipment, measuring equipment, industrial robotics, domestic appliances, etc.). These TOSHIBA products are neither intended nor warranted for usage in equipment that requires extraordinarily high quality and/or reliability or a malfunction or failure of which may cause loss of human life or bodily injury ("Unintended Usage"). Unintended Usage include atomic energy control instruments, airplane or spaceship instruments, transportation instruments, traffic signal instruments, combustion control instruments, medical instruments, all types of safety devices, etc. Unintended Usage of TOSHIBA products listed in this document shall be made at the customer's own risk. 021023_B
- The products described in this document shall not be used or embedded to any downstream products of which manufacture, use and/or sale are prohibited under any applicable laws and regulations. 060106_Q
- The information contained herein is presented only as a guide for the applications of our products. No responsibility is assumed by TOSHIBA for any infringements of patents or other rights of the third parties which may result from its use. No license is granted by implication or otherwise under any patent or patent rights of TOSHIBA or others. 021023_C
- The products described in this document are subject to the foreign exchange and foreign trade laws. 021023_E

About solderability, following conditions were confirmed

- Solderability
 - (1) Use of Sn-37Pb solder Bath
 - solder bath temperature = 230°C
 - dipping time = 5 seconds
 - the number of times = once
 - use of R-type flux
 - (2) Use of Sn-3.0Ag-0.5Cu solder Bath
 - solder bath temperature = 245°C
 - dipping time = 5 seconds
 - the number of times = once
 - use of R-type flux