

TOSHIBA Bipolar Linear Integrated Circuit Silicon Monolithic

TA2154AFN

1.5 V 1 Chip Tuner IC (for Digital Tuning System)

TA2154AFN is developed for 1.5 V headphone stereos. It incorporates all the functions of an FM/TV front end, AM/FM IF, and FM multiplex.

The IC can be used for IF count digital tuning systems. Since the IC divides the buffer output frequency by 16 while suppressing the FM/TV local oscillation level, the IC can suppress unnecessary emission, facilitating conformance to the new FCC specifications (part 15).

Features

- FM/TV local oscillator level is low (Built-in auto level control circuit)
- Suitable for combination with digital tuning system, which is included IF counter.
- One terminal type AM/FM IF count output for IF counter of digital tuning system.
 - AM: 450 kHz
 - FM: 10.7 MHz
- One terminal type FM/TV local oscillator.
- Local oscillator buffer output terminal shared by AM, FM and TV
 - AM: 1/1
 - FM: 1/32
 - TV: 1/8
- For adopting ceramic discriminator, it is not necessary to adjust the FM quad detector circuit.
- Built-in FM MPX VCO circuit.
- Low supply current ($V_{CC} = 1.2 \text{ V}$, $T_a = 25^\circ\text{C}$)
 - $I_{ccq}(\text{AM}) = 5.0 \text{ mA (typ.)}$
 - $I_{ccq}(\text{FM}) = 13.0 \text{ mA (typ.)}$
 - $I_{ccq}(\text{TV}) = 13.5 \text{ mA (typ.)}$
- Operating supply voltage: $V_{CC} = 1.0\sim 2.2 \text{ V}$ ($T_a = 25^\circ\text{C}$)
- Monaural operating supply voltage: $V_{CC} = 0.95\sim 2.2 \text{ V}$ ($T_a = 25^\circ\text{C}$)

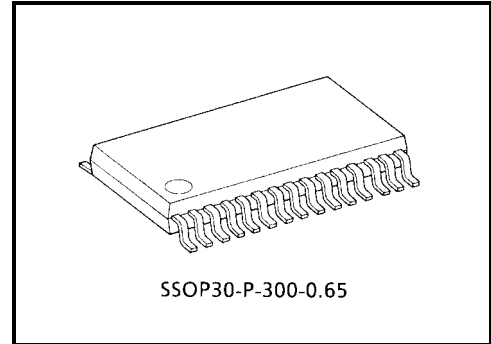

Weight: 0.17 g (typ.)

Block Diagram

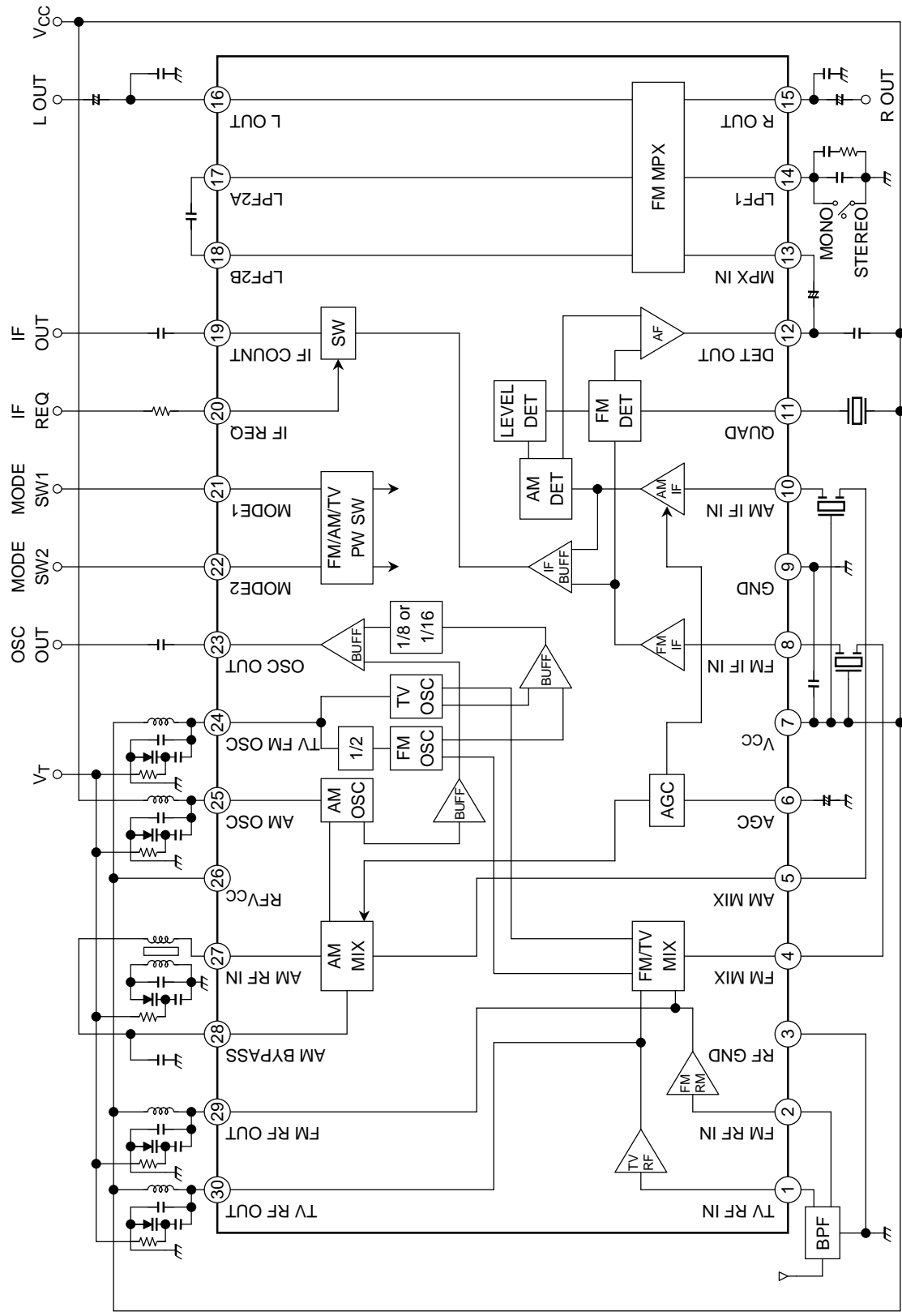

Explanation of Terminals

Terminal voltage: Typical terminal voltage at no signal with the test circuit ($V_{CC} = 1.2\text{ V}$, $T_a = 25^\circ\text{C}$)

Pin No.	Name	Function	Internal Circuit	Terminal Voltage		
				AM	FM	TV
1	TV RF IN	Input of TV RF signal		0	0	0.1
2	FM RF IN	Input of FM RF signal		0	0.1	0
3	RF-GND	GND (GND for TV/FM stage)	—	0	0	0
4	FM MIX	Output of TV/FM signal		—	0.5	0.5
5	AM MIX	Output of AM IF signal		0.6	—	—
6	AGC	AGC • AGC time constant is determined by external capacitor		0	0	0
7	V_{CC}	V_{CC} (V_{CC} for AM, FM IF, MPX stage)	—	1.2	1.2	1.2

Pin No.	Name	Function	Internal Circuit	Terminal Voltage		
				AM	FM	TV
8	FM IF IN	Input of FM IF signal Input impedance: 330 Ω (typ.)		—	0.7	0.7
9	GND	GND (GND for AM, FM IF, MPX stage)	—	0	0	0
10	AM IF IN	Input of AM IF signal Input impedance: 3 kΩ (typ.)		1.2	1.2	1.2
11	QUAD	FM QUAD detector		1.2	1.1	1.1
12	DET OUT	Detector output Output impedance AM: 4 kΩ (typ.) FM: 500 Ω (typ.)		0.6	0.8	0.8
13	MPX IN	Input of MPX		0.1	0.1	0.1

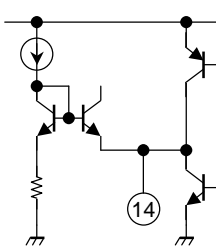
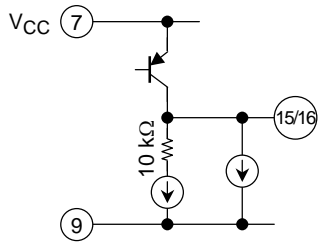
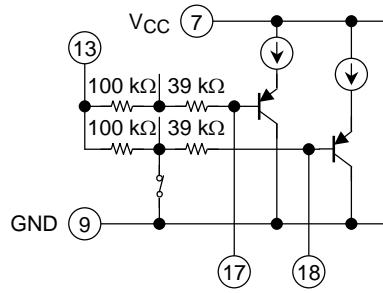
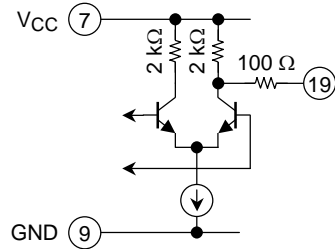
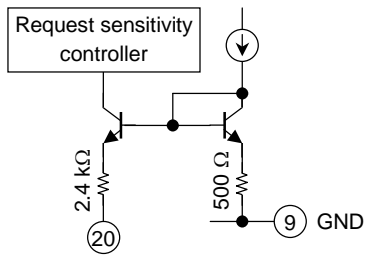
Pin No.	Name	Function	Internal Circuit	Terminal Voltage		
				AM	FM	TV
14	LPF1	LPF terminal for PLL phase detection. Connecting this terminal to GND sets the IC to forced Monaural mode.		—	—	—
15	R OUT	Output of Stereo signal		0.5	0.5	0.5
16	L OUT					
17	LPF2A	LPF terminals for synchronous detector		—	—	—
18	LPF2B					
19	IF COUNT	Output of IF count signal AM: 450 kHz FM: 10.7 MHz		1.2	1.2	1.2
20	IF REQ	IF request switch		—	—	—

Pin No.	Name	Function	Internal Circuit	Terminal Voltage		
				AM	FM	TV
21	MODE1	Mode switch		—	1.2	1.2
22	MODE2	Standby: AM: OPEN FM: V _{CC} TV: V _{CC} MODE1: OPEN MODE2: OPEN V _{CC} : V _{CC}		1.2	—	1.2
23	OSC OUT	Local oscillation buffer output		1.0	1.0	1.0
24	TV/FM OSC	TV/FM OSC		1.2	1.2	1.2
25	AM OSC	AM OSC		1.2	1.2	1.2
26	RFV _{CC}	V _{CC} for TV/FM F/E stage	—	—	—	
27	AM RF IN	Input of AM RF signal		0.9	—	—
28	AM BYPASS	Referential voltage bypass terminal for AM RF		0.9	—	—
29	FM RF OUT	FM RF turning circuit	Cf. pin 2	1.2	1.2	1.2
30	TV RF OUT	TV RF turning circuit	Cf. pin 1	1.2	1.2	1.2

Application Note

1. Mode switch

The IC controls the mode using pins 21 and 22. Switch conditions by modes are as listed below:

	MODE1 (pin 21)	MODE2 (pin 22)
Standby	OPEN	OPEN
AM	OPEN	V _{CC}
FM	V _{CC}	OPEN
TV	V _{CC}	V _{CC}

To change mode, a 10 μ A (typ.) current must flow from the IC to the pin connected to V_{CC}. When the pin is open, set the pin voltage to 0.2 V or less (typ.).

2. Forced monaural switch

Forced monaural switch over is done by pin 14.

In case of the electrical switch over by transistor, set up V_{CE} (saturation voltage between collector and emitter) 100 mV or less, otherwise there are some cases that it does not become forced monaural (VCO STOP) mode.

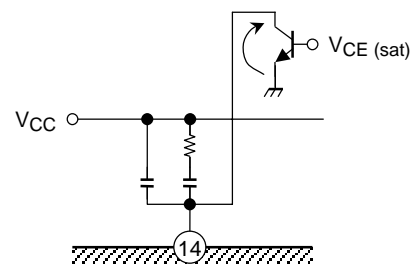

3. IF count output

To output the signal for IF count, connect IF REQ (pin 20) to GND via R_{SEN} and input the IF count sensitivity or larger.

	Switch Condition			Output Frequency	Output Voltage	Output Impedance
	MODE1	MODE2	IF REQ			
AM	OPEN	V _{CC}	Grounded via R _{SEN}	450 kHz	180 mVp-p	2 k Ω
FM	V _{CC}	OPEN		10.7 MHz	190 mVp-p	
TV	V _{CC}	V _{CC}		10.7 MHz	190 mVp-p	

4. Constant of LPF

Caputer range and Lock range is decided by constant of LPF, pin 14, 17, 18.

Care should be taken in changing constant of LPF. Otherwise there are some cases that stereo characteristics may worse or IC may not operate stereo mode.

5. TV/FM local oscillator

This IC uses the same oscillator for TV and FM. The circuit structure is shown below. In TV mode, the IC inputs the local oscillator frequency to the mixer as-is. In FM mode, the IC halves the local oscillator frequency then inputs it to the mixer. This is how the IC receives TV and FM band frequencies.

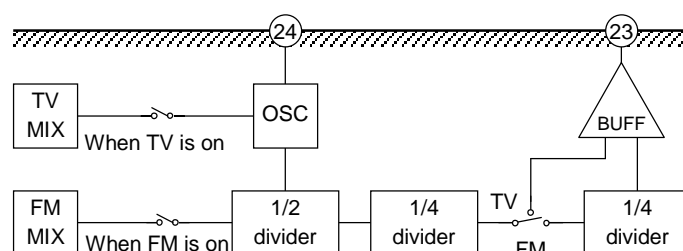

Maximum Ratings (Ta = 25°C)

Characteristics	Symbol	Rating	Unit
Supply voltage	V _{CC}	4.5	V
Power dissipation	P _D (Note 2)	550	mW
Operating temperature	T _{opr}	-10~60	°C
Storage temperature	T _{stg}	-55~150	°C

Note 2: Derated above Ta = 25°C in the proportion of 4.4 mW/°C.

Electrical Characteristics

Unless otherwise specified

: V_{CC} = 1.2 V, Ta = 25°C, FM F/E: f = 98 MHz, f_m = 1 kHz, Δf = ±75 kHz, V_{in} = 60dBμV EMF

FM IF: f = 10.7 MHz, f_m = 1 kHz, Δf = ±75 kHz, V_{in} = 80dBμV EMF

AM: f = 1000 kHz, f_m = 1 kHz, MOD = 30%, V_{in} = 60dBμV EMF

MPX: f_m = 1 kHz, f_p = 19 kHz

Characteristics		Symbol	Test Circuit	Test Condition	Min	Typ.	Max	Unit
Supply current		I _{CC1}	—	PW SW off			20	μA
		I _{CC2}	—	AM mode, V _{in} = 0		5.0	7	mA
		I _{CC3}	—	FM mode, V _{in} = 0		13.0	17	
		I _{CC4}	—	TV mode, V _{in} = 0		13.5	17	
FM F/E	Input limiting voltage	V _{in (lim)}	—	Point where detection output is -3dB with V _{in} = 60dBμV EMF as reference	—	12	—	dBμV EMF
	Local OSC buffer output voltage	V _{osc (Buff) FM}	—	f _{osc} = 6.79375 MHz (217.4 MHz divided by 32)	150	200	—	mVp-p
TV F/E	Input limiting voltage	V _{in (lim)}	—	Point where detection output is -3dB with V _{in} = 60dBμV EMF as reference		14		dBμV EMF
	Local oscillator buffer output	V _{osc (Buff) TV}	—	f _{osc} = 26.3375 MHz (210.7 MHz divided by 8)	150	200		mVp-p
FM IF	Input limiting voltage	V _{in (lim)}	—	Point where detection output is -3dB with V _{in} = 80dBμV EMF as reference	37	42	47	dBμV EMF
	Recovered output voltage	V _{OD (FM)}	—	—	115	140	180	mVrms
	Signal to noise ratio 1	S/N (FM)	—	—	—	73	—	dB
	Total harmonic distortion 1	THD (FM)	—	—	—	0.2	—	%
	AM rejection ration	AMR (FM)	—	MOD = 30%	—	62	—	dB
	IF count output voltage	V _{IF (FM)}	—	—	150	190	—	mVp-p
	IF count sensitivity	IF _{SENS (FM)}	—	R _{SEN} = 3.3 kΩ	48	53	58	dBμV EMF
AM	Gain	G _v	—	V _{in} = 32dBμV EMF	19	29	51	mVrms
	Recovered output voltage	V _{OD (AM)}	—	—	27	40	54	mVrms
	Signal to noise ratio 2	S/N (AM)	—	—	—	37	—	dB
	Total harmonic distortion 2	THD (AM)	—	—	—	13	—	%
	Local OSC buffer output voltage	V _{osc (Buff) AM}	—	f _{osc} = 14.5 MHz	130	180	—	mVp-p
	IF count output voltage	V _{IF (AM)}	—	—	140	180	—	mVp-p
		IF count sensitivity	IF _{SENS (AM)}	—	R _{SEN} = 3.3 kΩ	27	32	37

Characteristics		Symbol	Test Circuit	Test Condition	Min	Typ.	Max	Unit		
MPX	Input resistance	R_{IN}	—	—	—	26	—	k Ω		
	Output resistance	R_{OUT}	—	—	—	10	—			
	Voltage gain	G_V	—	$V_{in} = 150 \text{ mVrms (MONO)}$	-2.5	-0.5	+1.5	dB		
	Channel balance	C.B.	—		-2.0	0	+2.0			
	Max composite signal input level	$V_{in} \text{ (max)}$	—	L + R = 90%, P = 10%, THD = 3%		—	250	—	mVrms	
	Separation		SEP.	—	L + R = 135 mVrms, P = 15 mVrms	$f_m = 100 \text{ Hz}$	—	40	—	dB
						$f_m = 1 \text{ kHz}$	30	40	—	
						$f_m = 10 \text{ kHz}$	—	40	—	
	Total harmonic distortion	MONO	THD (MONO)	—	$V_{in} = 150 \text{ mVrms (MONO)}$		—	0.2	—	%
		ST	THD (ST)	—	L + R = 135 mVrms, P = 15 mVrms		—	0.4	—	
	ST indicator sensitivity	ON	ST (ON)	—	—		—	5.7	8.5	mVrms
		OFF	ST (OFF)	—			1.0	3.2	—	mVrms
	Stereo indicator hysteresis		V_H	—	To indicator turn OFF from turn ON		—	2.5	—	mVrms
Capture range		C.R.	—	P = 15 mVrms		—	14	—	%	
Signal to noise ratio		S/N3	—	$V_{in} = 150 \text{ mVrms (MONO)}$		—	70	—	dB	

Test Circuit

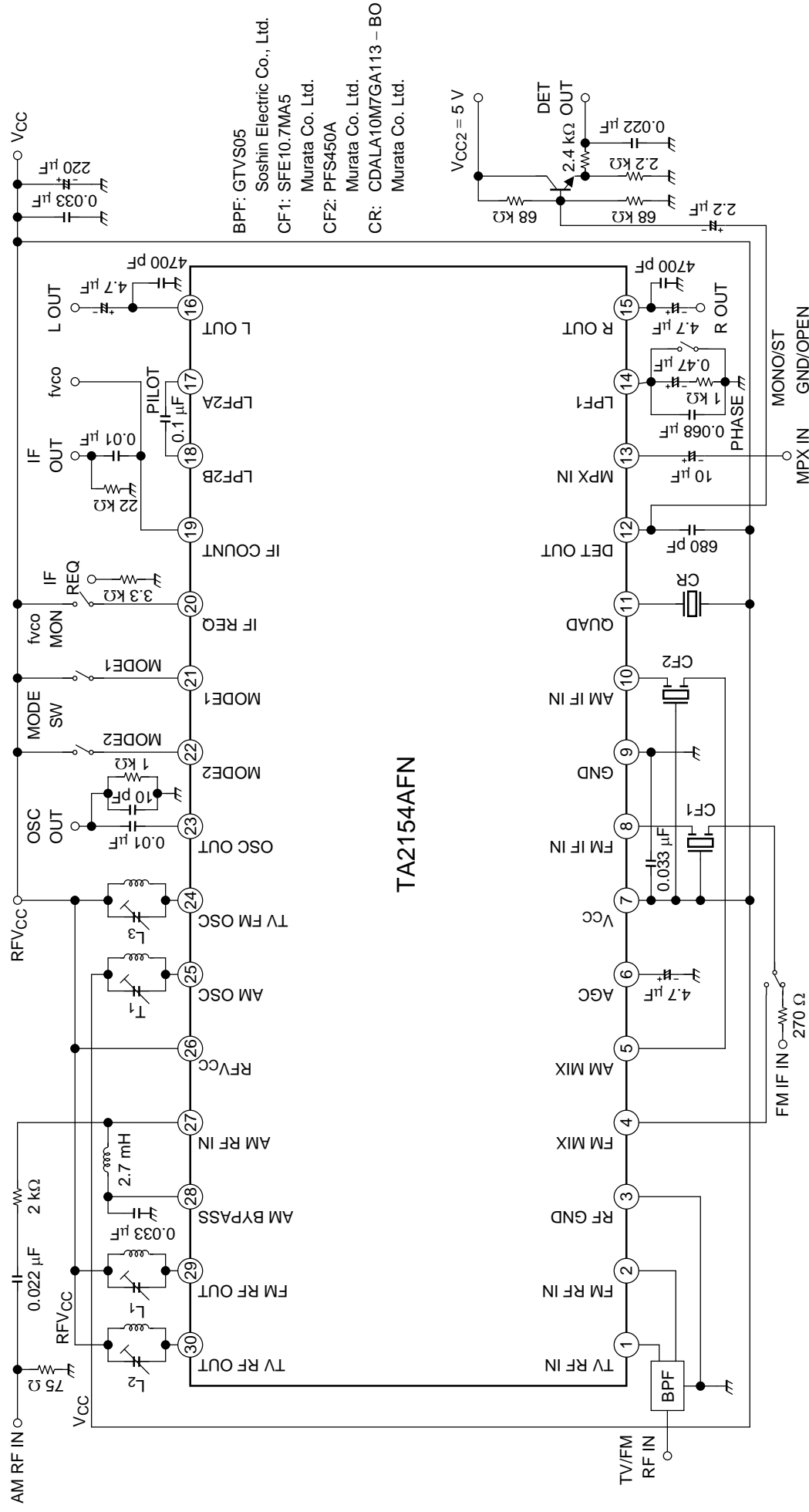

BPF: GTVS05
Soshin Electric Co., Ltd.
CF1: SFE10.7MA5
Murata Co. Ltd.
CF2: PFS450A
Murata Co. Ltd.
CR: CDALA10M7GA113 - BO
Murata Co. Ltd.

TA2154AFN

Coil Data

Coil	Test Frequency	L (μH)	Co (pF)	Q0	Turns				Wire (mmφ)	
					1-2	2-3	1-3	4-6		
L ₁ FM RF	100 MHz	—	—	79	—	—	2 $\frac{1}{2}$	—	0.16UEW	TOKO 666SNF-305NK
L ₂ TV RF	100 MHz	—	—	73	—	—	1 $\frac{1}{4}$	—	0.16UEW	TOKO 666SNF-381NK
L ₃ TV/FM OSC	100 MHz	—	—	73	—	—	1 $\frac{1}{4}$	—	0.16UEW	TOKO 666SNF-381NK
T ₁ AM OSC	796 kHz	268	—	65	19	95	—	—	0.05UEW	TOKO 5PNR-4957Y

L₁: FM RF

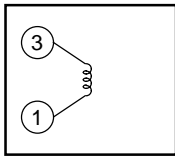

L₂: TV RF

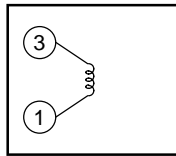

L₃: TV/FM OSC

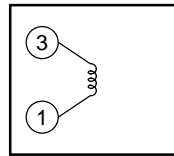

T₁: AM OSC

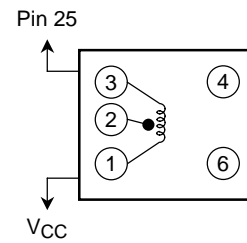

(BOTTOM VIEW)

Package Dimensions



Weight: 0.17 g (typ.)

RESTRICTIONS ON PRODUCT USE

000707EBA

- TOSHIBA is continually working to improve the quality and reliability of its products. Nevertheless, semiconductor devices in general can malfunction or fail due to their inherent electrical sensitivity and vulnerability to physical stress. It is the responsibility of the buyer, when utilizing TOSHIBA products, to comply with the standards of safety in making a safe design for the entire system, and to avoid situations in which a malfunction or failure of such TOSHIBA products could cause loss of human life, bodily injury or damage to property.
In developing your designs, please ensure that TOSHIBA products are used within specified operating ranges as set forth in the most recent TOSHIBA products specifications. Also, please keep in mind the precautions and conditions set forth in the "Handling Guide for Semiconductor Devices," or "TOSHIBA Semiconductor Reliability Handbook" etc..
- The TOSHIBA products listed in this document are intended for usage in general electronics applications (computer, personal equipment, office equipment, measuring equipment, industrial robotics, domestic appliances, etc.). These TOSHIBA products are neither intended nor warranted for usage in equipment that requires extraordinarily high quality and/or reliability or a malfunction or failure of which may cause loss of human life or bodily injury ("Unintended Usage"). Unintended Usage include atomic energy control instruments, airplane or spaceship instruments, transportation instruments, traffic signal instruments, combustion control instruments, medical instruments, all types of safety devices, etc.. Unintended Usage of TOSHIBA products listed in this document shall be made at the customer's own risk.
- The products described in this document are subject to the foreign exchange and foreign trade laws.
- The information contained herein is presented only as a guide for the applications of our products. No responsibility is assumed by TOSHIBA CORPORATION for any infringements of intellectual property or other rights of the third parties which may result from its use. No license is granted by implication or otherwise under any intellectual property or other rights of TOSHIBA CORPORATION or others.
- The information contained herein is subject to change without notice.