

TA31145FNG

FM IF DETECTOR IC FOR PAGER (Built-in 2nd MIX)

FEATURES

- Built-in RSSI function
To prevent input overload, RSSI output controls RF attenuator
- Built-in 2nd MIX for double conversion method
Mix operating frequency: 10~50MHz
- Built-in low pass filter and waveform shaping circuit enable the extraction of FSK signals from voice signal
- High transmit rate : 1200bps (Typ.)
- Built-in battery-saving function
It is possible to reduce load of the battery which is functioning as power supply
- Battery alarm function (ALM)
Alarm sensitivity : $V_{ALM} = 1.1V$ (Typ.)
- Constant voltage power supply can be fabricated through externally adding a transistor
Output voltage : $V_{REG} = 1.0V$ (Typ.)
- Extremely low current consumption : $I_{CC} = 1.2mA$ (Typ.)
- Power supply voltage : $V_{CC} = 1.1\sim 3.5V$
- Small package : SSOP20PIN (0.65mm pitch)

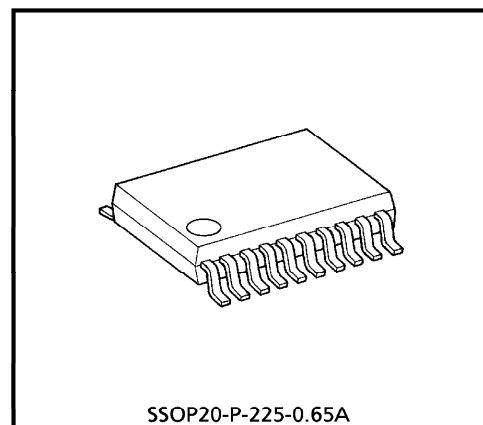

SSOP20-P-225-0.65A

Weight : 0.09g (Typ.)

BLOCK DIAGRAM

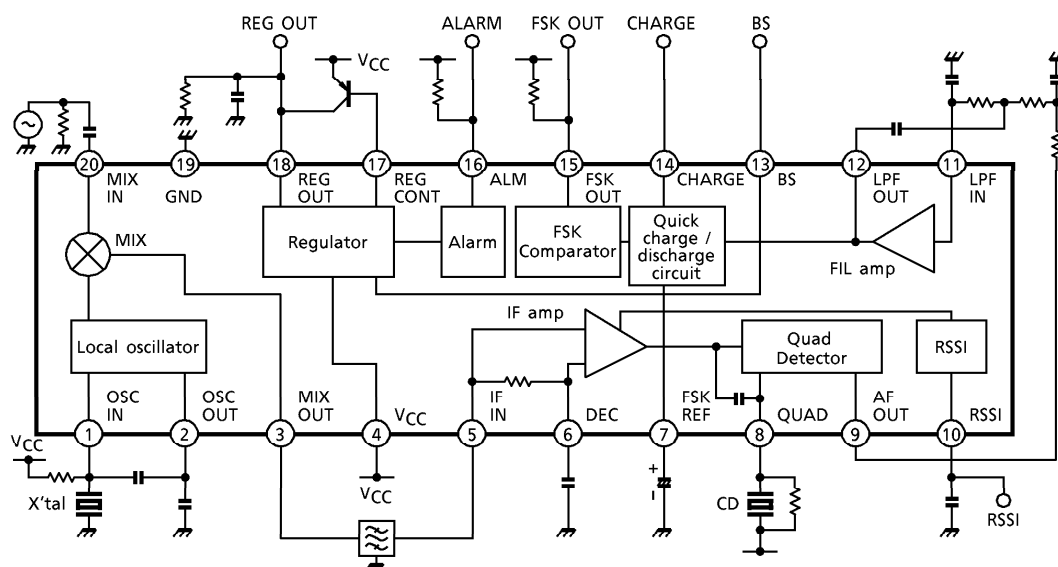

The TA31145FNG package is Pb-Free.

PIN FUNCTION

PIN No.	PIN NAME	FUNCTION	INTERNAL EQUIPMENT CIRCUIT (RESISTOR AND CAPACITOR) ARE TYP. VALUES.				
1	OSC IN	Local oscillator input terminal. In case of oscillating by X'tal, connect to this terminal.					
2	OSC OUT	Local oscillator output terminal. In case of input from external circuit, input to this terminal.					
3	MIX OUT	Mixer output terminal. Output impedance is $2k\Omega$ (Typ.).					
4	VCC	Power supply terminal.	—				
5	IF IN	IF amp input terminal (pin 5) and bias decoupling terminal (pin 6). Input impedance is $2k\Omega$ (Typ.).					
6	DEC						
8	QUAD	Phase-shift input terminal for FM demodulator. Connect to the discriminator.					
9	AF OUT	Output terminal for FM demodulator.					
10	RSSI	RSSI output terminal.					
13	BS	Battery-saving control terminal. <table border="1" style="margin-left: auto; margin-right: auto;"> <tr> <td>"H"</td> <td>Battery-saving OFF state</td> </tr> <tr> <td>"L"</td> <td>Battery-saving state</td> </tr> </table>	"H"	Battery-saving OFF state	"L"	Battery-saving state	
"H"	Battery-saving OFF state						
"L"	Battery-saving state						

PIN No.	PIN NAME	FUNCTION	INTERNAL EQUIPMENT CIRCUIT (RESISTOR AND CAPACITOR ARE TYP. VALUES.)				
11	LPF IN	LPF input terminal. Bias is supplied from pin 9 through external resistor.					
12	LPF OUT	LPF output terminal. This output is composed by operation amplifier.					
7	FSK REF	Reference input terminal of differential amplifier which is waveform shaping section. Connect a capacitor externally. By the quick charge / discharge circuit of push-pull output, potentials of pin 7 and pin 12 can be made equal.					
15	FSK OUT	Output terminal for waveform shaping. FSK signal, which is input from LPF OUT (pin 12) and of which waveform is shaped, is output as inverted signal. Connect a pull-up resistor, because it is open collector output.					
14	CHARGE	Control terminal for quick charge / discharge circuit. <table border="1" style="margin-left: auto; margin-right: auto;"> <tr> <td>"H"</td> <td>Quick charge / discharge ON</td> </tr> <tr> <td>"L"</td> <td>Quick charge / discharge OFF</td> </tr> </table>	"H"	Quick charge / discharge ON	"L"	Quick charge / discharge OFF	
"H"	Quick charge / discharge ON						
"L"	Quick charge / discharge OFF						
16	ALM	Output terminal for ALARM. At $V_{CC} \approx 1.1V$, this terminal output becomes "H" ($\approx V_{CC}$) and can indicate deterioration of battery. Connect pull-up resistor, because it is open-collector output.					
17	REG CONT	External transistor for terminal for regulator of external power supply. Connect the PNP transistor externally.					
18	REG OUT	Output voltage monitoring terminal for regulator of external power supply.					
19	GND	GND Terminal.	—				
20	MIX IN	Input terminal for MIX. section. Input impedance is $5k\Omega$ (Typ.).					

FUNCTIONS

1. Battery-saving function

Since the battery-saving function is built-in, this IC can minimize the consumption of battery by means of reducing the current consumption by the battery-saving function when the battery is used as the power supply of the set.

As the BS terminal (pin 13) is base of the NPN transistor, its input impedance is high and it can be driven with low power. Therefore, this function can be directly driven by CMOS output of microcomputer.

BS TERMINAL (PIN 13) STATE	BATTERY-SAVING FUNCTION	OTHER INTERNAL CIRCUIT OPERATION STATES	QUIESCENT CURRENT CONSUMPTION OF IC
L	Battery-saving ON	Operation stop	0 μ A (Typ.)
H	Battery-saving OFF	Normal operation	1.2mA (Typ.)

2. Waveform shaping circuit

The FM detected signal is converted into digital signal by the waveform shaping circuit (configured with comparator). Thus, accurate signal digitization can be achieved when this IC is in a weak electric field or there is noise in the FSK signal. Therefore reading errors of the microcomputer are reduced.

The waveform shaping circuit of this IC uses the time constant of the capacitor connected to the FSK REF terminal (pin 7) and the internal resistance to integrate the FM detected signal. The resulting voltage is used as the reference (threshold) voltage to shape the waveform and output the waveform-shaped signal from the FSK OUT terminal (pin 15)

3. Quick charge / discharge circuit

When operation state turn to the battery-saving OFF state (Normal operation state) from the battery-saving state, if the FSK signal is input, the time that the FSK REF terminal (pin 7) arrives at the reference voltage is delayed by the time constant determined by the capacitor connected to the FSK REF terminal (pin 7) and the internal resistance.

In this case, sometimes the erroneous waveform-shaping signal is output because of the error of the input voltage of the waveform shaping circuit (comparator).

In such a case, by means of charging or discharging quickly the capacitor connected to the FSK REF terminal (pin 7) by the quick charge / discharge circuit, the time that the FSK REF terminal (pin 7) becomes the same potential as that of the LPF OUT terminal (pin 12) is shortened, and the FSK output of the erroneous waveform shaping signal is prevented.

* When CHARGE terminal (pin 14) is at "H", the quick charge / discharge circuit becomes active state.

4. Alarm function

In case the battery is used as the power supply of the set, when the power supply voltage is reduced and the voltage of the V_{CC} terminal (pin 4) becomes approximately. 1.1V, the output of the ALM terminal (pin 16) rises up to approximately. 1.1V ($\approx V_{CC}$) and the consumption of the battery power can be detected.

5. Constant voltage regulator for power supply of external part

As shown in the following diagram, connecting the PNP transistor to the REG CONT terminal (pin 17) allows the REG OUT terminal (pin 18) to be used for high-output constant voltage : $V_{REG} = 1.0V$ (Typ.). During battery-saving, the constant voltage output is OFF.

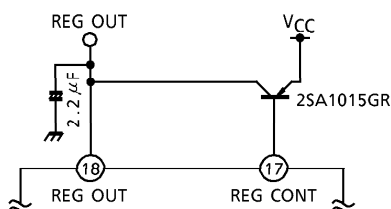

When connecting an external resistor "R" to the REG OUT terminal (pin 18) to raise the output voltage, oscillation may occur in the regulator output. To avoid this, connect a capacitor "C" as shown in the following diagram.

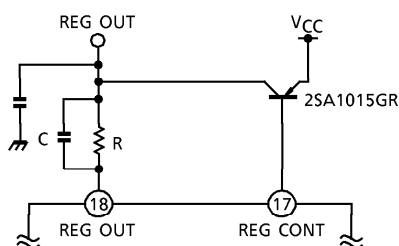

6. Local oscillation circuit

Local oscillation circuit is Colpitts type oscillator composed by internal emitter follower circuit and external X'tal. Connect as shown in the figure below.

Connect a base bias resistor between pin 1 and V_{CC} or REG OUT terminal (pin 18).

In case of need to increase the current of local oscillation circuit in order to compose the overtone oscillation and improve the stability of oscillation, connect a resistor between pin 2 and GND. In such a case we recommend connecting a base bias resistor between pin 1 and pin 18, or the external regulator (is under the control of the battery-saving). (If a base bias resistor is connected between pin 1 and V_{CC} , the current flows across a resistor connected between pin 2 and GND during battery saving.)

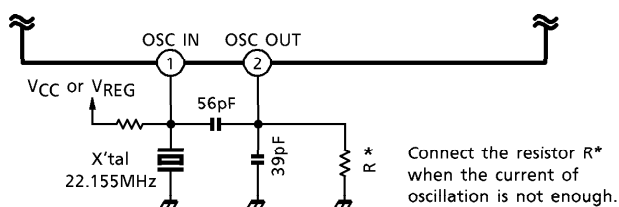

7. RSSI function

The RSSI terminal (pin10) outputs a DC potential corresponding to the IF IN terminal (pin5) input level. As the RSSI output is converted into voltage by an internal resistance ($82k\Omega$), its characteristics can be changed as shown in the following diagram. In this case, note that owing to displacement of temperature coefficient between external resistance and internal resistance, the temperature characteristics of the RSSI output may change. Because of the internal circuit structure, do not connect the RSSI terminal (pin10) directly to GND.

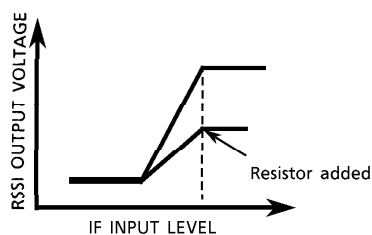
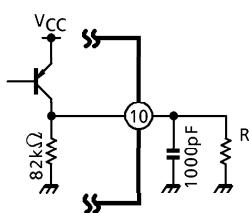

MAXIMUM RATINGS (Ta = 25°C)

CHARACTERISTIC	SYMBOL	RATING	UNIT
Power Supply Voltage	V _{CC}	4	V
Power Dissipation	P _D	710	mW
Operating Temperature	T _{opr}	-30~85	°C
Storage Temperature	T _{stg}	-55~150	°C

ELECTRICAL CHARACTERISTICS

(Ta = 25°C Unless otherwise specified, V_{CC} = 1.4V, f_{in} (MIX) = 21.7MHz, f_{in} (IF) = 455kHz,)
Dev = ±4kHz, f_m = 600Hz

CHARACTERISTIC	SYMBOL	TEST CIR-CUIT	TEST CONDITION	MIN.	TYP.	MAX.	UNIT
Operating Voltage Range	V _{CC}	—	—	1.1	1.4	3.5	V
Quiescent Current Consumption	I _{CCQ}	2	—	—	1.2	1.7	mA
Current Consumption at BS	I _{CCO}	3	—	—	0	5	μA
Mixer Conversion Gain	GM _V	1 (1)	Measured through ceramic filter	9	12.5	16	dB
Mixer Intercept Point	I _p	—	—	—	97	—	dB _{μV}
Mixer Input Resistance	R (MIX) IN	—	—	—	5	—	kΩ
Mixer Output Resistance	R (MIX) OUT	—	—	—	2	—	kΩ
IF AMP Input Resistance	R (IF) IN	—	—	—	2	—	kΩ
SN Ratio 1	S / N 1	1 (3)	MIX IN, V _{IN} (MIX) = 60dB _{μV} EMF	—	63	—	dB
SN Ratio 2	S / N 2	1 (2)	IF IN, V _{IN} (IF) = 60dB _{μV} EMF	—	63	—	dB
SN Ratio 3	S / N 3	1 (2)	IF IN, V _{IN} (IF) = 25dB _{μV} EMF	—	35	—	dB
Limiting Sensitivity 1	V _I (LIM) 1	1 (3)	MIX IN	—	14	—	dB _{μV} EMF
Limiting Sensitivity 2	V _I (LIM) 2	1 (2)	IF IN	—	23	27	dB _{μV} EMF
Demodulated Output Level	V _{OD}	1 (2)	V _{IN} (IF) = 60dB _{μV} EMF	30	45	65	mV _{rms}
AM Rejection Ratio	AMR	1 (2)	V _{IN} (IF) = 60dB _{μV} EMF, AM = 30%	—	50	—	dB
FSK Output Duty Ratio	DR	1 (4)	V _{IN} (IF) = 60dB _{μV} EMF	40	50	60	%
Alarm Detected Voltage	V _{ALM}	1 (5)	—	1.05	1.1	1.15	V
"L" Level Output Voltage (ALM)	V _{ALM L}	1 (6)	I = 100μA	—	—	0.4	V
"H" Level Leak Current (ALM)	I _{ALM}	1 (7)	—	—	—	2	μA
"L" Level Output Voltage (FSK)	V _{FSK L}	1 (8)	I = 100μA	—	—	0.4	V
"H" Level Leak Current (FSK)	I _{FSK}	1 (9)	—	—	—	2	μA
Constant Voltage Output	V _{REG}	1 (10)	R _L = 430Ω	0.95	1.0	1.05	V
RSSI Output Voltage	V _{RSSI}	1 (12)	V _{IN} (IF) = 65dB _{μV} EMF	0.45	0.6	0.80	V
RSSI Output Resistance	R _{RSSI}	—	—	—	82	—	kΩ
Quick Charge / Discharge Current	I _{CH}	4	V ₇ = 0V, V ₁₂ = 0.18V	35	70	110	μA
"L" Level Output Voltage (REG CONT)	REG L	1 (11)	I = 100μA	—	—	0.6	V

TEST CIRCUIT 1

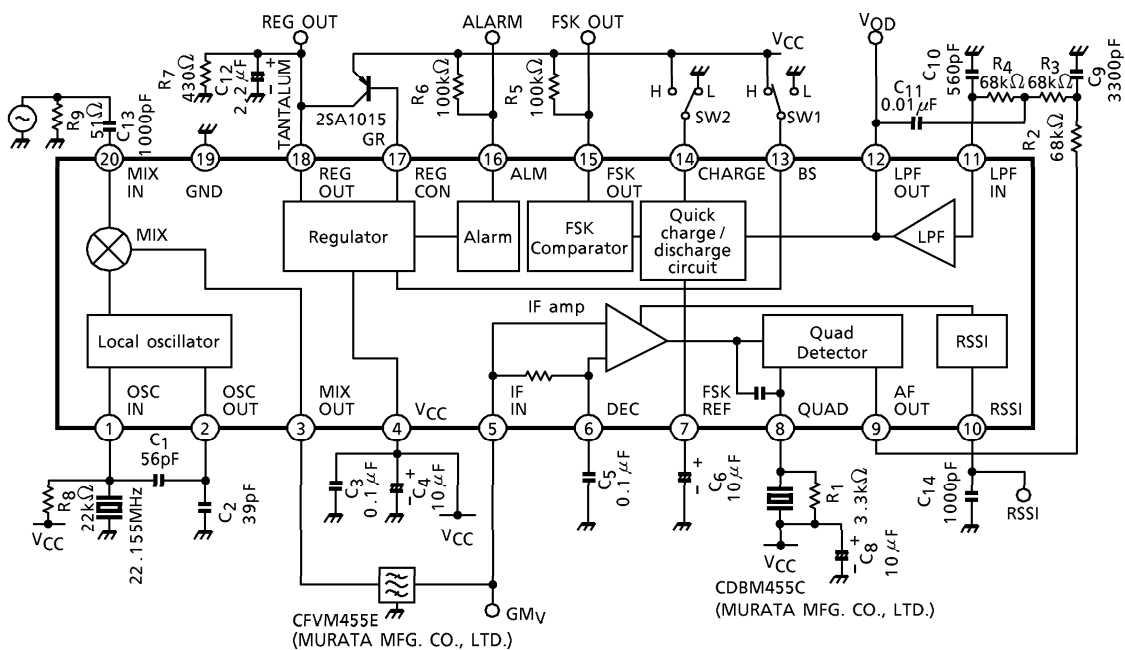

(1) GMV

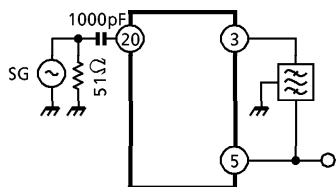

(2) SN2, SN3, V_I (LIM) 2, V_{OD}, AMR

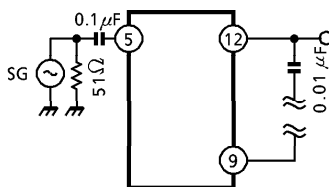

(3) SN1, V_I (LIM) 1

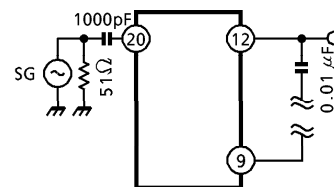

(4) DR

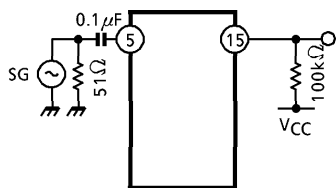

(5) V_{ALM}

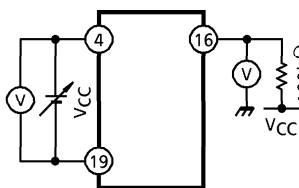

(6) V_{ALM} L

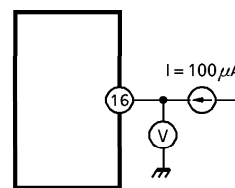

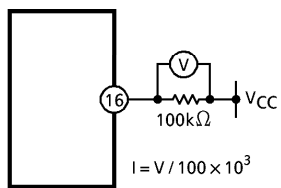
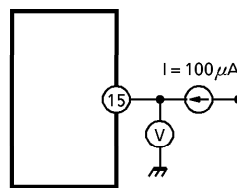
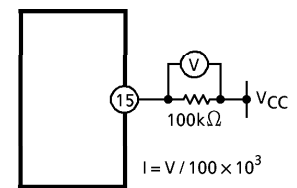
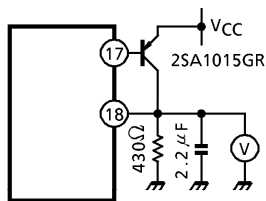
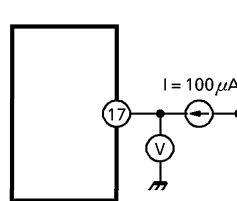
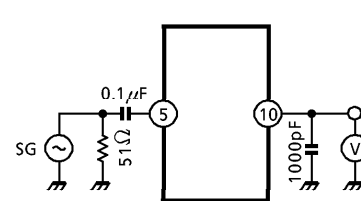
(7) I_{ALM} (8) $V_{FSK L}$ (9) I_{FSK} (10) V_{REG} (11) $V_{REG L}$ (12) V_{RSSI} 

Test condition TEST CIRCUIT 1.

TEST CIRCUIT 2

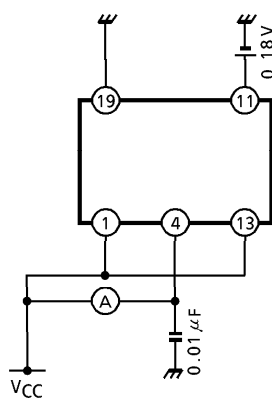
 I_{CCQ} 

TEST CIRCUIT 3

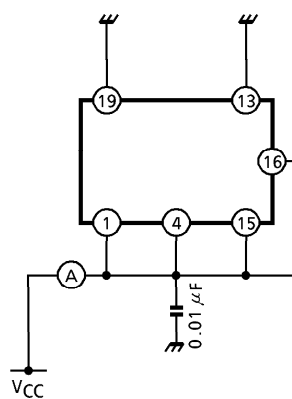
 I_{CCO} 

TEST CIRCUIT 4

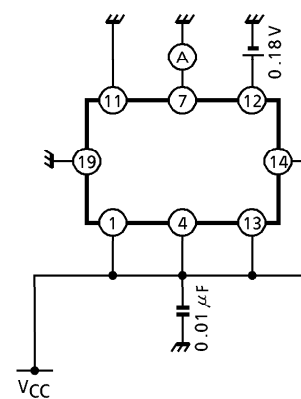
 I_{CH} 

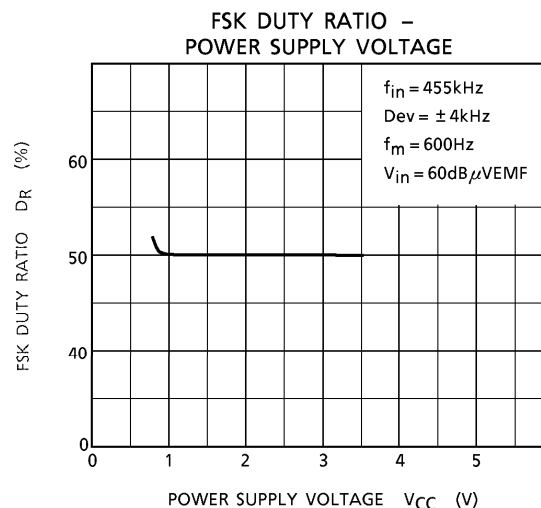
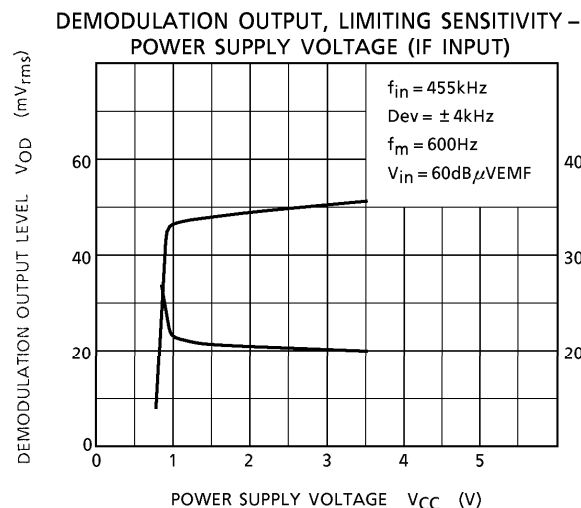
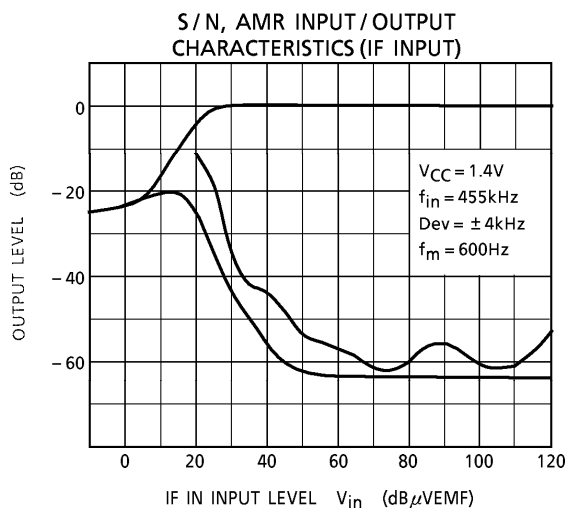
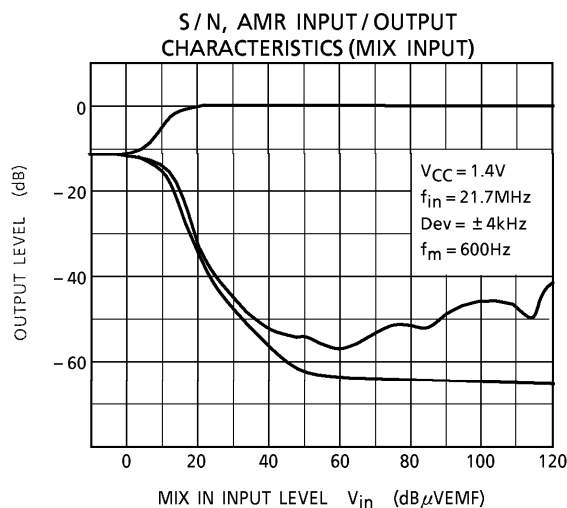
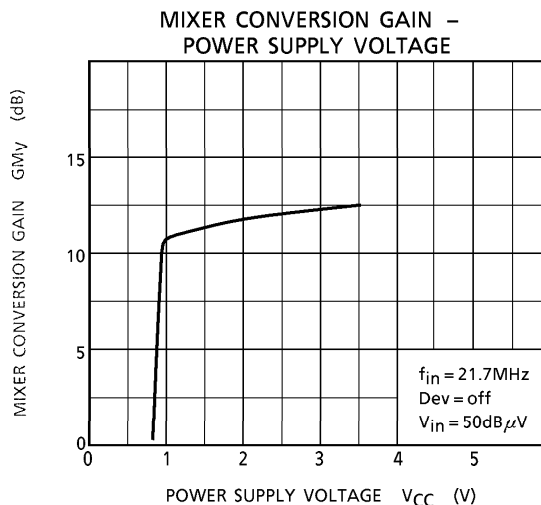
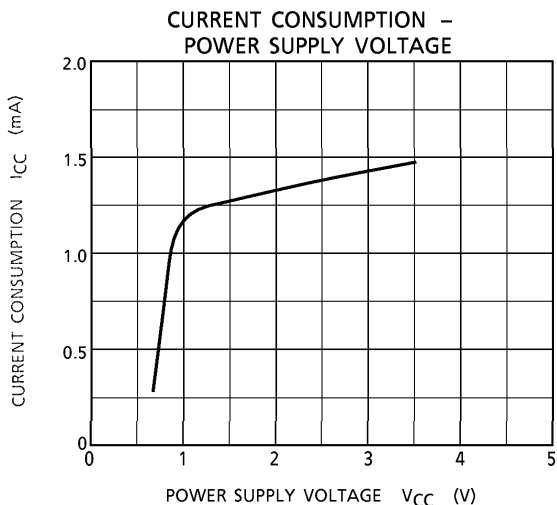

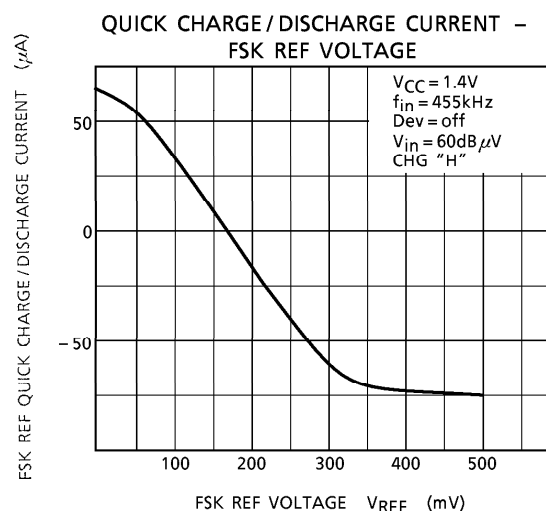
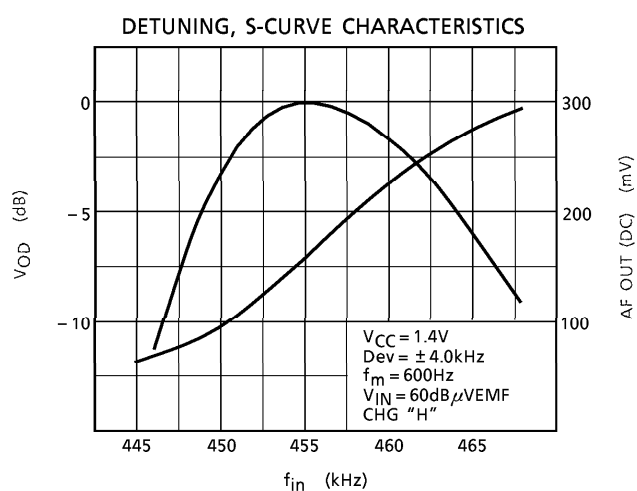
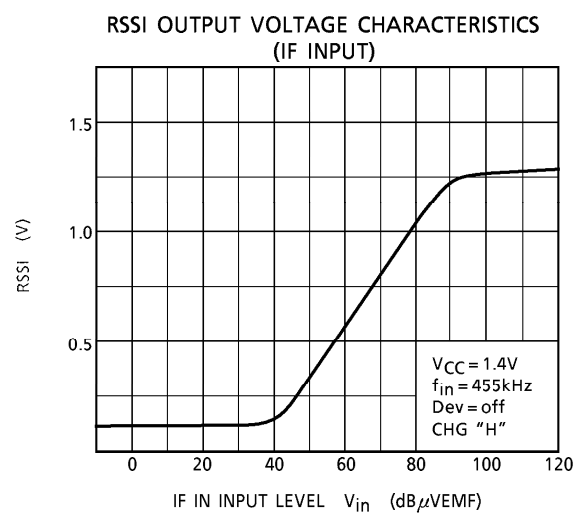
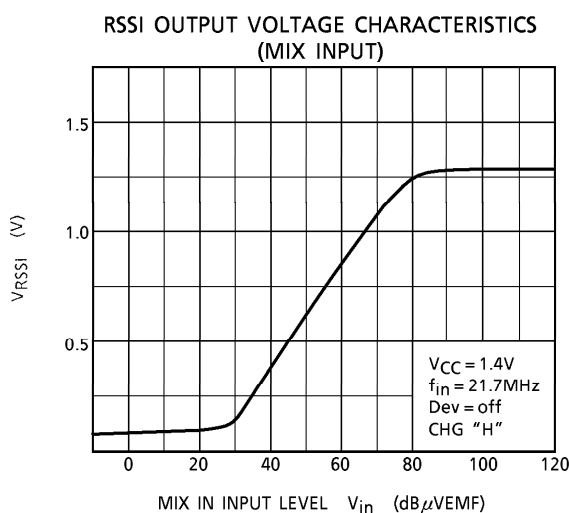
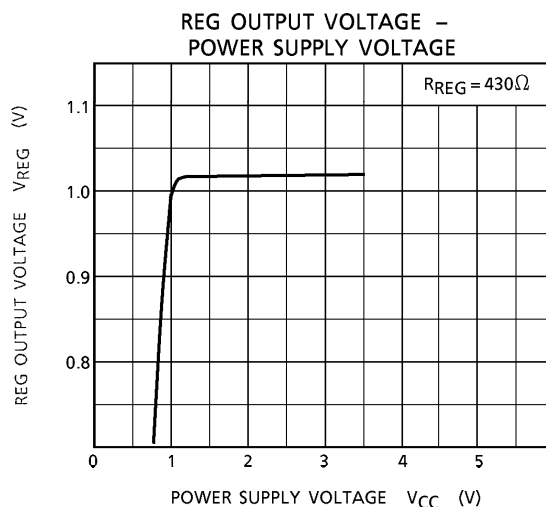
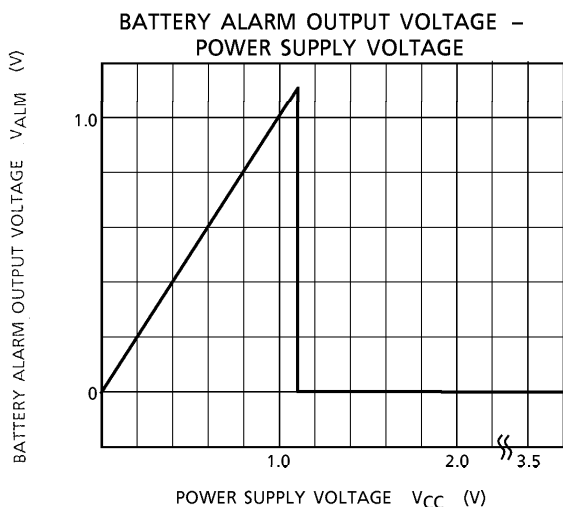

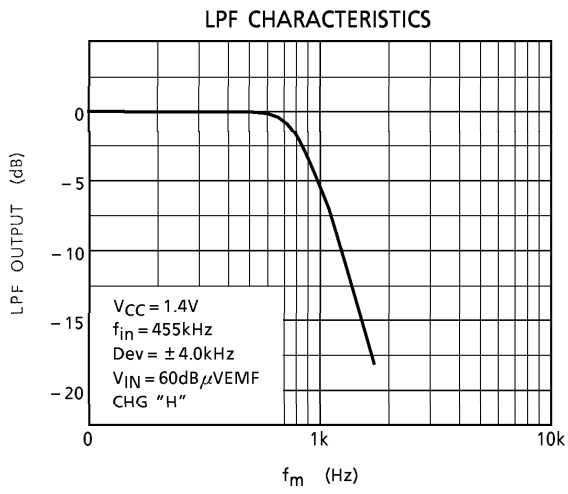

et4

Dc

PACKAGE DIMENSIONS
SSOP20-P-225-0.65A

Unit : mm

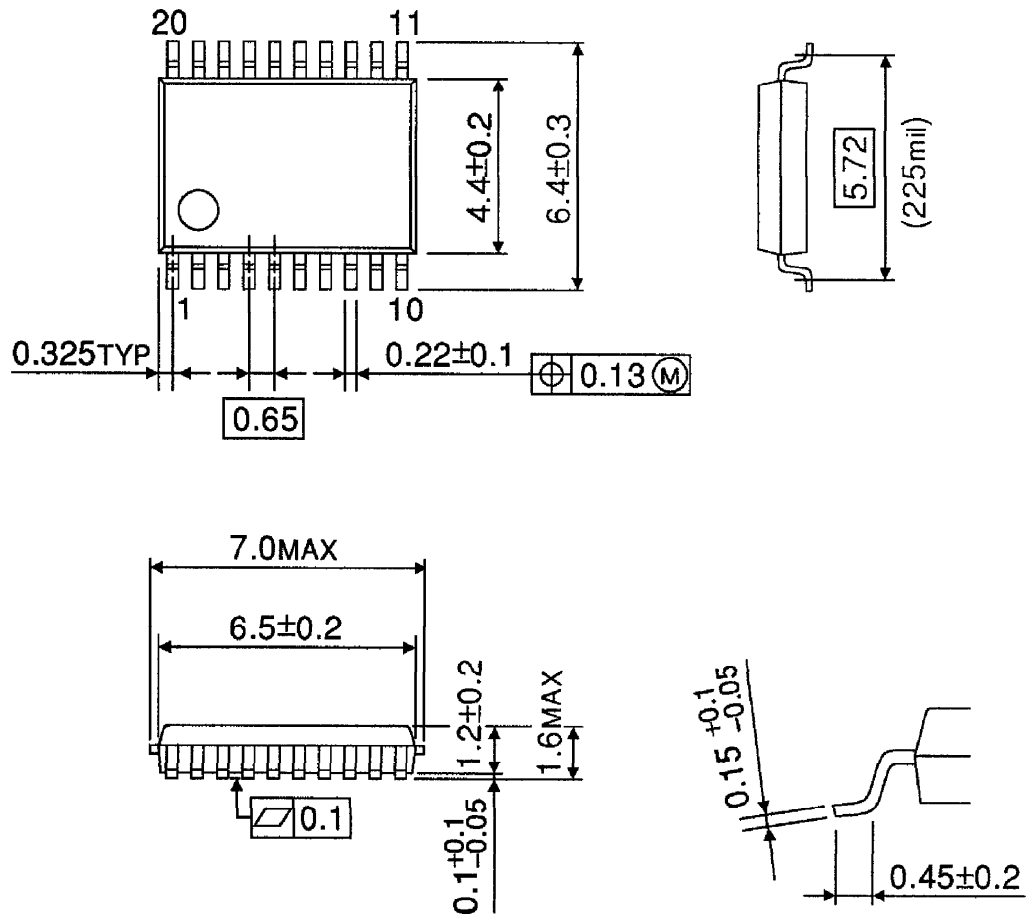

Weight : 0.09g (Typ.)

Notice for Pb free product

About solderability, following conditions were confirmed

Solderability

- (1) Use of Sn-36Pb solder bath
 - solder bath temperature = 230
 - dipping time = 5seconds
 - the number of times = once
 - use of R-type flux
- (2) Use of Sn-3.0Ag-0.5Cu solder bath
 - solder bath temperature = 245
 - dipping time = 5seconds
 - the number of times = once
 - use of R-type flux

RESTRICTIONS ON PRODUCT USE

000707EBA

- TOSHIBA is continually working to improve the quality and reliability of its products. Nevertheless, semiconductor devices in general can malfunction or fail due to their inherent electrical sensitivity and vulnerability to physical stress. It is the responsibility of the buyer, when utilizing TOSHIBA products, to comply with the standards of safety in making a safe design for the entire system, and to avoid situations in which a malfunction or failure of such TOSHIBA products could cause loss of human life, bodily injury or damage to property. In developing your designs, please ensure that TOSHIBA products are used within specified operating ranges as set forth in the most recent TOSHIBA products specifications. Also, please keep in mind the precautions and conditions set forth in the "Handling Guide for Semiconductor Devices," or "TOSHIBA Semiconductor Reliability Handbook" etc..
- The TOSHIBA products listed in this document are intended for usage in general electronics applications (computer, personal equipment, office equipment, measuring equipment, industrial robotics, domestic appliances, etc.). These TOSHIBA products are neither intended nor warranted for usage in equipment that requires extraordinarily high quality and/or reliability or a malfunction or failure of which may cause loss of human life or bodily injury ("Unintended Usage"). Unintended Usage include atomic energy control instruments, airplane or spaceship instruments, transportation instruments, traffic signal instruments, combustion control instruments, medical instruments, all types of safety devices, etc.. Unintended Usage of TOSHIBA products listed in this document shall be made at the customer's own risk.
- The products described in this document are subject to the foreign exchange and foreign trade laws.
- The information contained herein is presented only as a guide for the applications of our products. No responsibility is assumed by TOSHIBA CORPORATION for any infringements of intellectual property or other rights of the third parties which may result from its use. No license is granted by implication or otherwise under any intellectual property or other rights of TOSHIBA CORPORATION or others.
- The information contained herein is subject to change without notice.