

**▶ Product Introduction****A New Package Type - Surface Mount Ceramic Housed Quartz Crystal Resonator.****Features :**

- Seam welded ceramic package, 1.2mm max. low profile.
- Ideally suit for disc driver, PCMCIA, PC and hand-held products.
- Tight stability, High reliability, Wide frequency range, High frequency.
- Rugged AT-cut crystal construction, Ultra miniature for maximum spacing saving.
- Tape and Reel packing method, Tight specifications available, RoHS Compliant.

Token Electronics offers two series SMD Quartz Crystals in terms of TA\*C series and TA\*CA series. The TA\*C series incorporates a sub-miniature AT-cut strip quartz crystal resonator packed in a miniature 4.0×2.5×1.2mm ceramic package, while the TA\*CA series incorporates a sub-miniature AT-cut strip quartz crystal unit housed in a miniature 2-pad 4.0×2.5mm ceramic package.

Both compact crystals chip components of TA\*C series and TA\*CA series are ideal for surface mount, densely-populated PCB applications.

Contact us with your specific needs. For more information, please link to Token official website "[Crystal Resonator](http://www.token.com.tw)".



**Dimensions**

**Configurations & Dimensions (TA7C/6C/5C/4C)**

Part Number	Dimensions (unit: mm)								
	L1	L2	L3	L4	L5	L6	L7	L8	L9
TA4C TA4CA	4.0±0.3	2.5±0.3	1.2±0.2	1.2±0.2	0.9±0.2	4.2±0.2	2.7±0.2	1.4±0.2	1.1±0.2
TA5C TA5CA	5.0±0.3	3.2±0.3	1.2±0.2	1.4±0.2	1.0±0.2	5.2±0.2	3.4±0.2	1.6±0.2	1.2±0.2
TA6C TA6CA	6.0±0.3	3.5±0.3	1.2±0.2	1.5±0.2	1.2±0.2	6.2±0.2	3.7±0.2	1.8±0.2	1.4±0.2
TA7C TA7CA	7.0±0.3	5.0±0.3	1.2±0.2	1.5±0.2	1.2±0.2	8.0±0.2	3.9±0.2	2.2±0.2	1.4±0.2

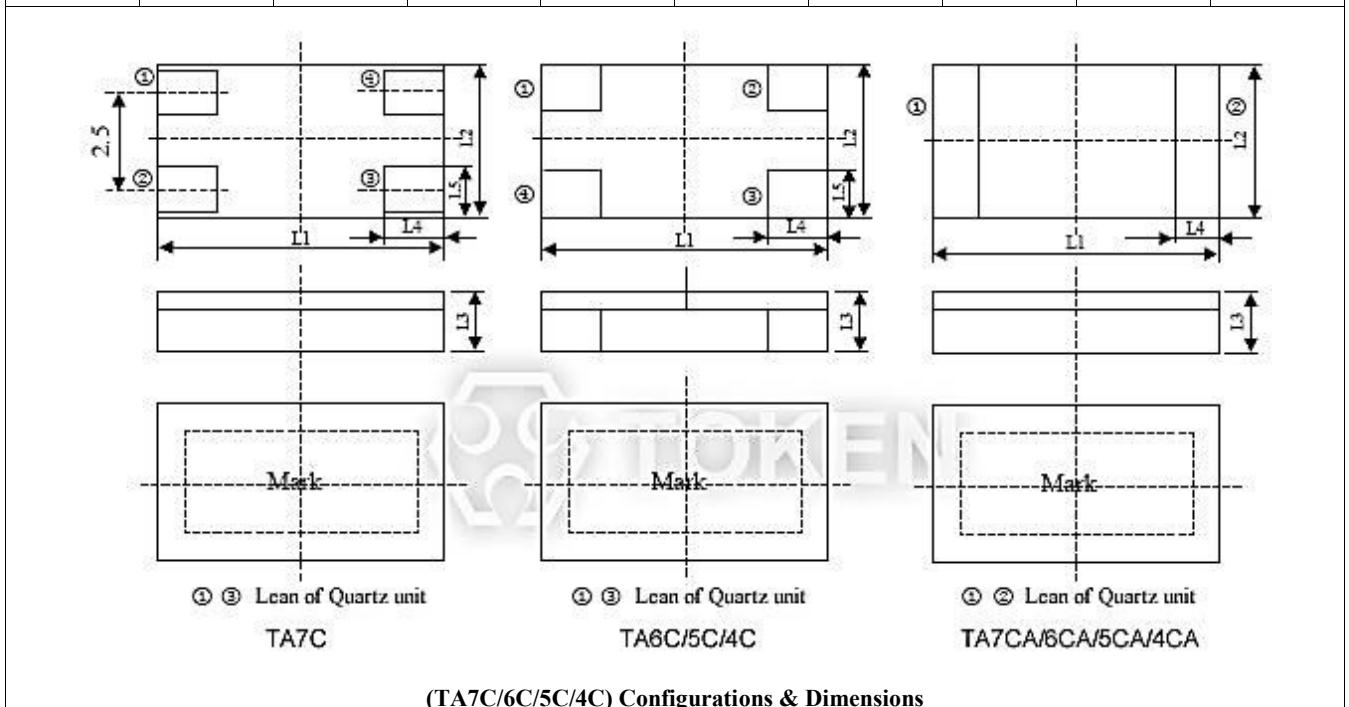

▶ **Electrical Spec.**

**Electrical Specifications (TA7C/6C/5C/4C)**

Part Number	Frequency Range (MHz)	Resonance Resistance ( $\Omega$ ) Max	Fundamental / Overtone	Adjustment Tolerance $\times 10^{-6}$	Temp.Range Tolerance Over $\times 10^{-6}$
TA4C TA4CA	12.000 ~ 19.999	80	Fundamental	30	50
	20.000 ~ 25.999	70			
	26.000 ~ 36.000	50			
TA5C TA5CA	10.000 ~ 11.999	120			
	12.000 ~ 14.399	80			
	14.400 ~ 36.000	50			
TA6C TA6CA	8.0000 ~ 11.999	80			
	12.000 ~ 16.000	60			
	16.001 ~ 40.000	40			
TA7C TA7CA	7.6000 ~ 11.999	80			
	12.000 ~ 16.000	60			
	16.001 ~ 35.000	40			

► Land Pattern

Recommended Land Pattern (TA7C/6C/5C/4C)

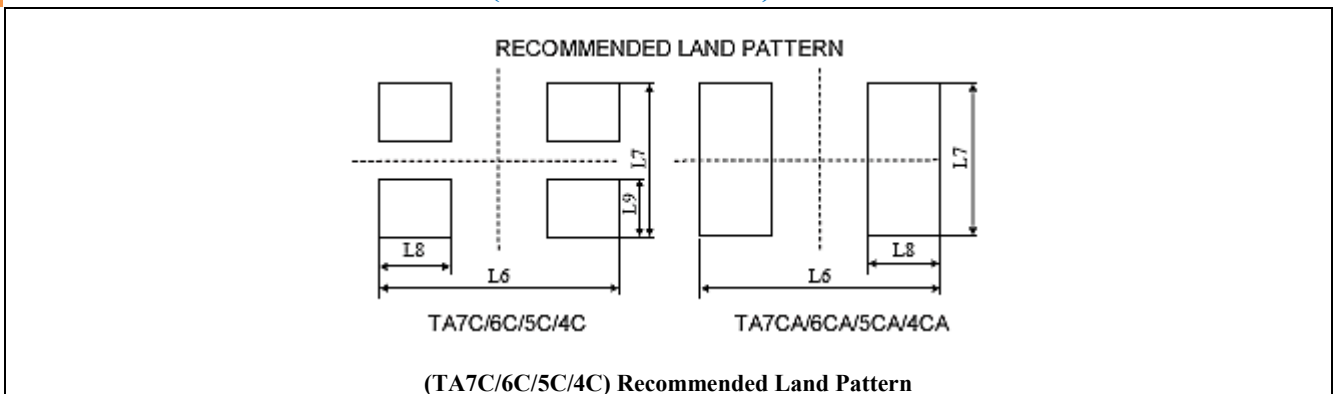

► Reflow Soldering

Recommended Reflow Soldering Standard Conditions (TA7C/6C/5C/4C)

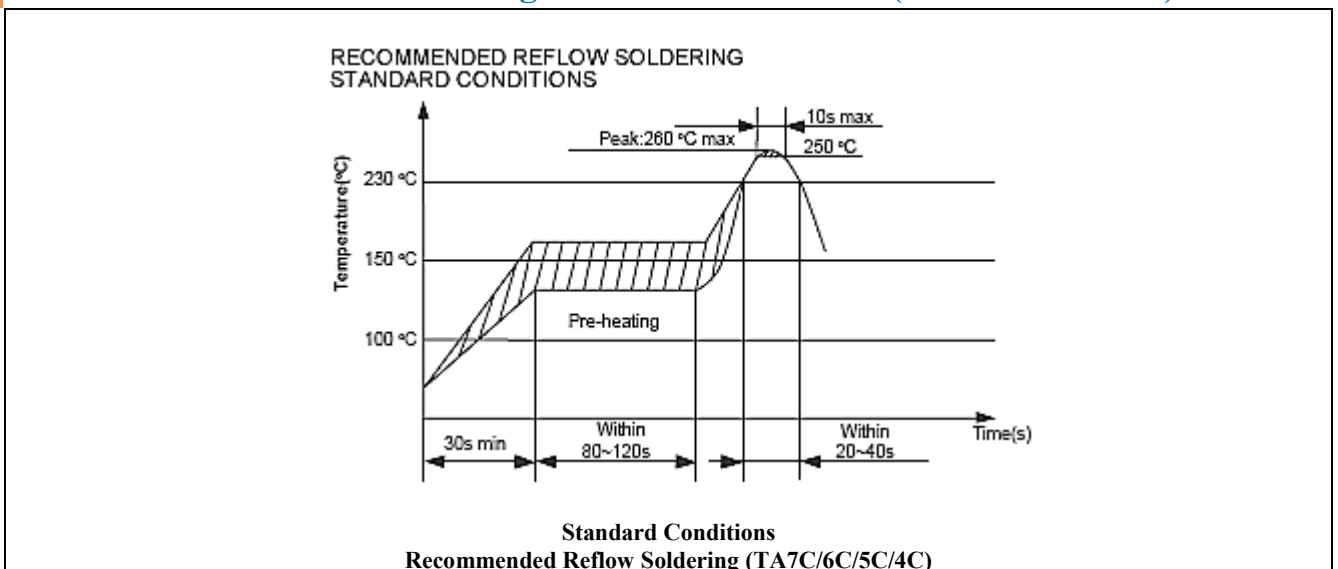

▶ Peeling Strength

Test Condition Of Peeling Strength (TA7C/6C/5C/4C)

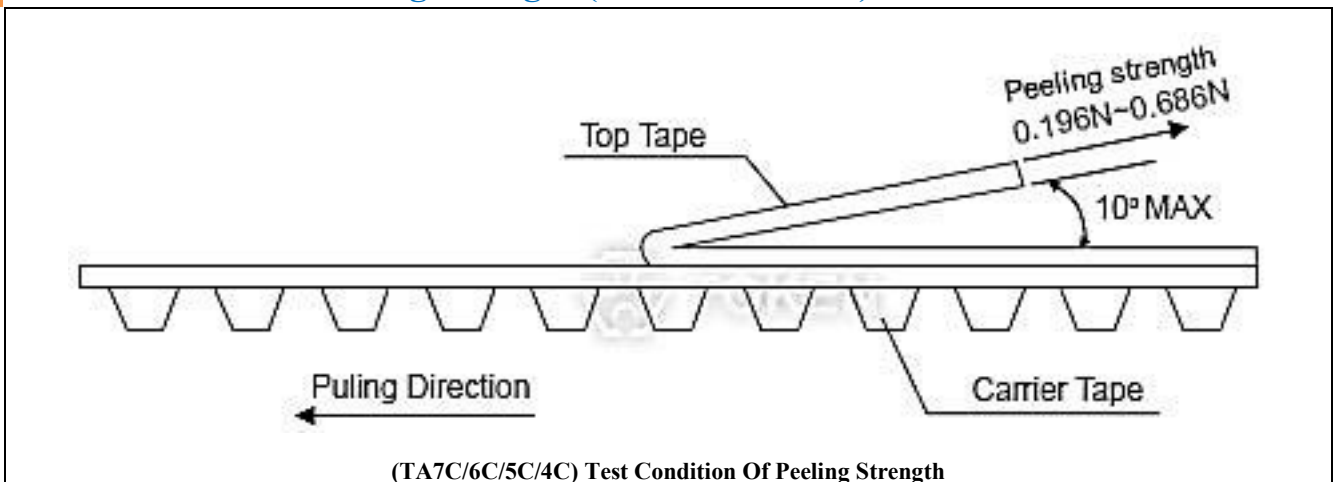

▶ Packing & Reel

Packing Method (TA7C/6C/5C/4C)

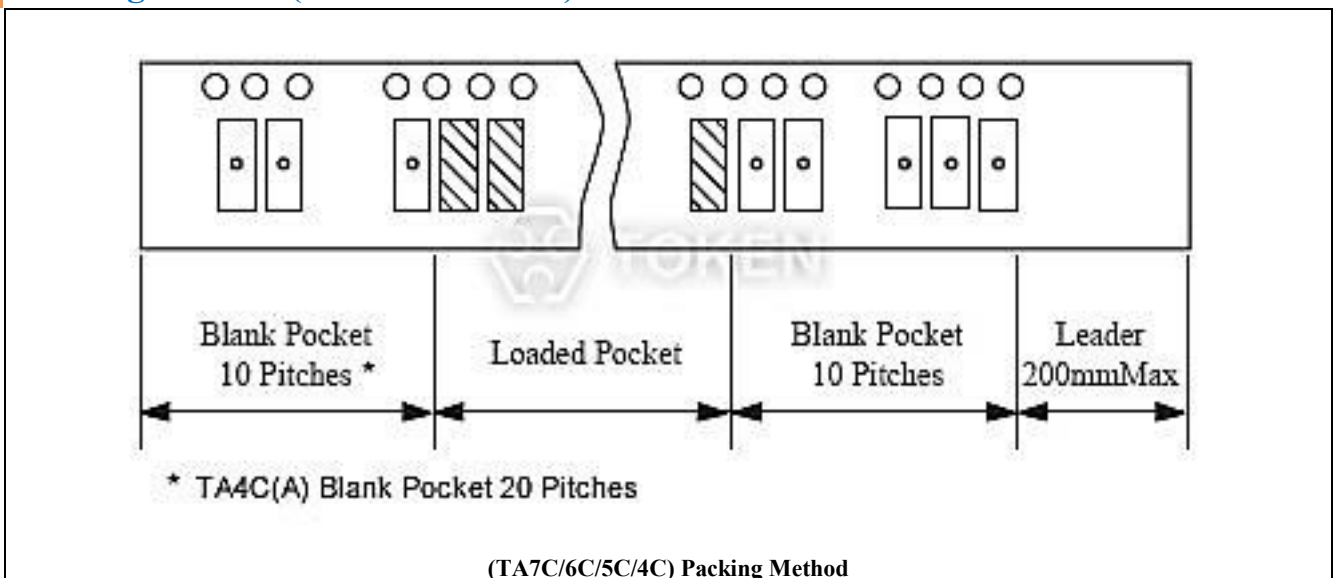

► Reel Dimensions

Reel Dimensions (Unit: mm) (TA7C/6C/5C/4C)

$\Phi A$	$\Phi B$	W	T	Pieces per reel	Carrier tape size
179 ± 2	60typ	12.4min	19.4max	3000typ	12
179 ± 2	60typ	16.4min	22.4max	1000typ	16
330 ± 3	80min	12.4min	19.4max	4000typ	12
330 ± 3	80min	16.4min	22.4max	4000typ	16
179 ± 2	60typ	8.4min	12.4max	3000typ	8

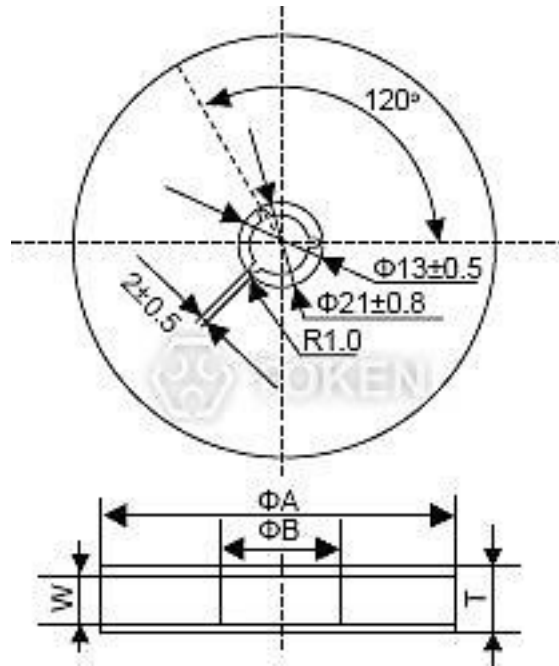

(TA7C/6C/5C/4C) Reel Dimensions

● \* typ : (Typical Value)

## Carrier Tape

### Carrier Tape Dimensions (TA7C/6C/5C/4C)

Part Number	Dimensions (unit: mm)													
	A	B	C	D	E	F	G	H	ΦJ	ΦN	Mmax	Rmax	K	T
TA4C TA4CA	2.9±0.2	4.4±0.2	12.0±0.2	5.5±0.1	1.75±0.1	4.0±0.1	4.0±0.1	2.0±0.1	1.5±0.1	1.6±0.1	10°	0.3	1.4±0.2	0.3±0.1
TA5C TA5CA	3.6±0.2	5.4±0.2	16.0±0.2	7.5±0.1	1.75±0.1	4.0±0.1	2.0±0.1	1.5±0.1	1.6±0.1	1.6±0.1	10°	0.3	1.4±0.2	0.3±0.1
TA6C TA6CA	3.9±0.2	6.4±0.2	16.0±0.2	7.5±0.1	1.75±0.1	4.0±0.1	2.0±0.1	1.5±0.1	1.6±0.1	1.6±0.1	10°	0.3	1.4±0.2	0.3±0.1
TA7C TA7CA	5.4±0.2	7.4±0.2	16.0±0.2	7.5±0.1	1.75±0.1	4.0±0.1	2.0±0.1	1.5±0.1	1.6±0.1	1.6±0.1	10°	0.3	1.4±0.2	0.3±0.1

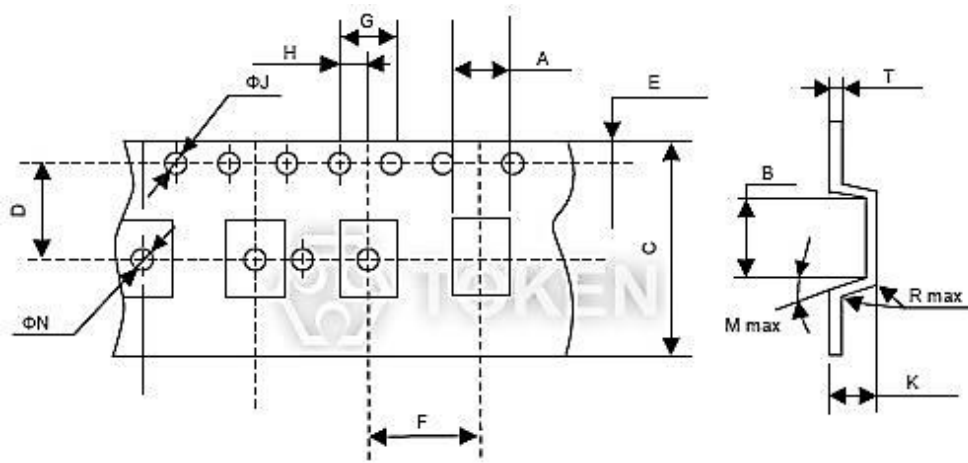

(TA7C/6C/5C/4C) Carrier Tape Dimensions

## Order Codes

### Order Codes (TA7C/6C/5C/4C)

TA6C	12.000M	TR
Part Number	Frequency (MHz)	Package
		P Bulk
		TR Taping Reel

## ▶ General Information

### Advantage of Token's New Ceramic Housed Crystal Units

The emergence of wireless communications and the increased need for wire line-based data transmissions have swelled demand for piezoelectric quartz crystals and oscillators. Emerging industrial and consumer applications are steering the industry.

Data transfer must be synchronized in high-bandwidth systems, a requirement that has boosted demand for timing products. Token crystal units and filters provide the precise timing signals needed to ensure reliable data transfer at high speeds in applications ranging from notebook computers to network switches.

Token use Piezoelectric processing techniques to craft resonators on quartz chips for time bases and provide very high initial accuracy and a moderately low temperature coefficient.

The markets for piezoelectric crystal products are characterized by price competition, and rapid technological change. Due to the increasing requirements for high-speed, high-frequency components as well as the demand of new consumer applications to the market, Token's ceramic housed crystal units resonators provide component engineers with a vast range of readily available solutions, necessary to meet the dynamic requirements of today's global market.