

DUAL COMPARATOR
VOLTAGE COMPARATOR

- Two Circuits/Package
- Possible to operate at +3V Single Supply
- Possible to gain Inverted Output
- Large Common Mode Voltage Range
- Absence of Latch-Up

Unit in mm

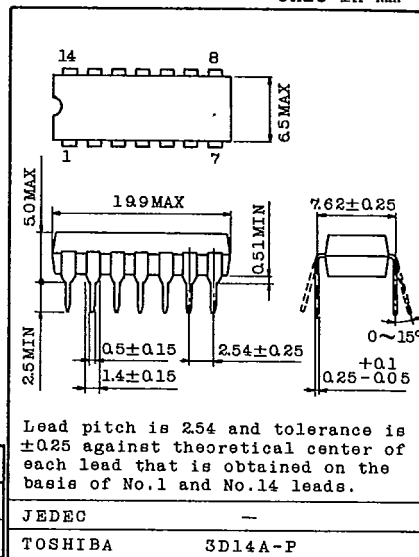

MAXIMUM RATINGS (Ta=25°C)

CHARACTERISTIC	SYMBOL	RATING	UNIT
Supply Voltage	V _{CC}	18	V
Power Dissipation	P _D	300	mW
Differential Input Voltage	DV _{IN}	±18	V
Common Mode Input Voltage	CMV _{IN}	+V _{CC} ~ -5	V
Sink Current	I _{sink}	20	mA
Operating Temperature	T _{opr}	-40 ~ 85	°C
Storage Temperature	T _{stg}	-55 ~ 125	°C

PIN CONNECTION (TOP VIEW)

COMP : FREQUENCY COMPENSATION TERMINAL

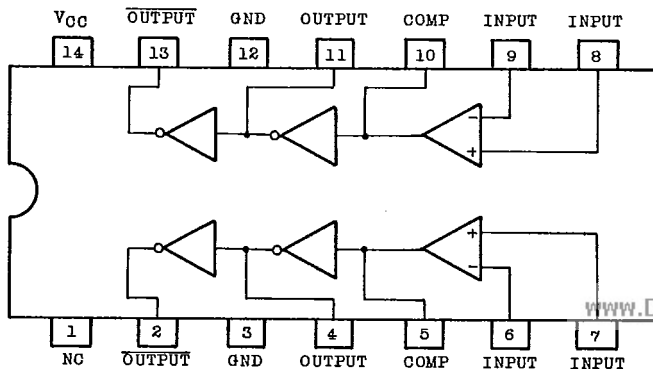

RECOMMENDED CONDITION

Supply Voltage	5 ~ 12	V
Common Mode Input Voltage	1 ~ (VCC-0.5)	V
Sink Current	10	mA

ELECTRICAL CHARACTERISTICS (VCC=6V, Ta=25°C)

CHARACTERISTIC		SYMBOL	TEST CIR-CUIT	TEST CONDITION	MIN.	TYP.	MAX.	UNIT
Input Offset Voltage		V_{IO}	-	$R_S \leq 100 \Omega$	-	1	5	mV
Input Offset Current		I_{IO}	-	-	-	15	50	nA
Input Bias Current		I_I	-	-	-	120	300	nA
Voltage Gain		$G_{\bar{V}}$	-	$R_L \geq 1k\Omega, f=100Hz$	75	85	-	dB
		$G_{\bar{V}}$	-	$R_L \geq 1k\Omega, f=100Hz$	80	95	-	dB
Output Voltage	"H" Level	V_{OH}	-	$I_{OH} = -2mA$	4.6	5.1	-	V
	"L" Level	V_{OL}	-	$I_{OL} = 10mA$	-	0.2	0.4	V
Common Mode Input Voltage	"H" Level	$CMV_{IN(H)}$	-	-	5.8	5.9	-	V
	"L" Level	$CMV_{IN(L)}$	-	-	-	0.8	0.9	V
Common Mode Input Signal Rejection Ratio		CMRR	-	$f=100Hz$	80	90	-	dB
Power Dissipation		P_D	-	-	-	15	25	mW

Note: $G_{\bar{V}}$: Inverted output voltage gain.

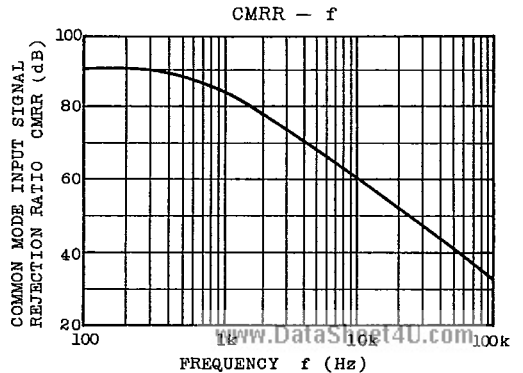
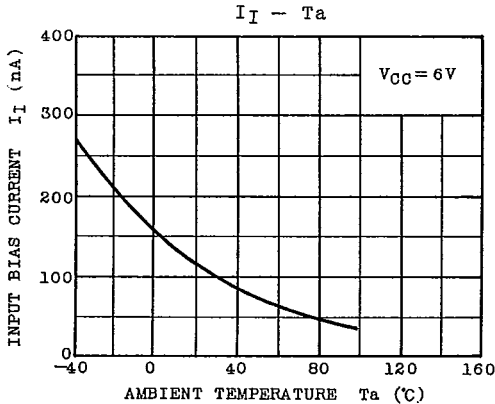
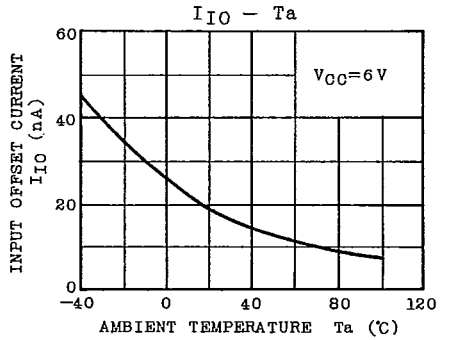
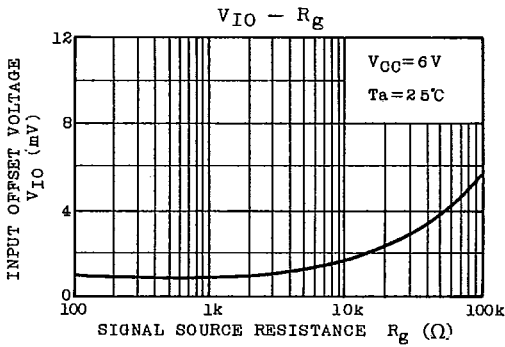
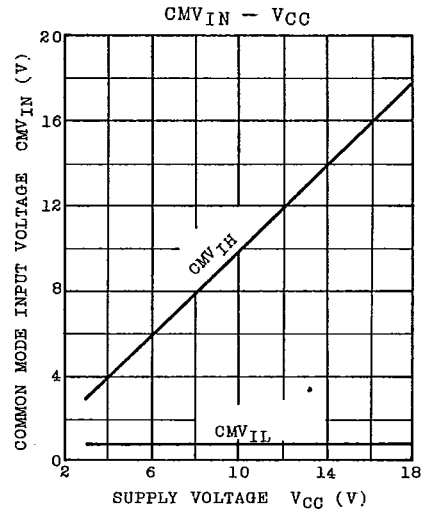
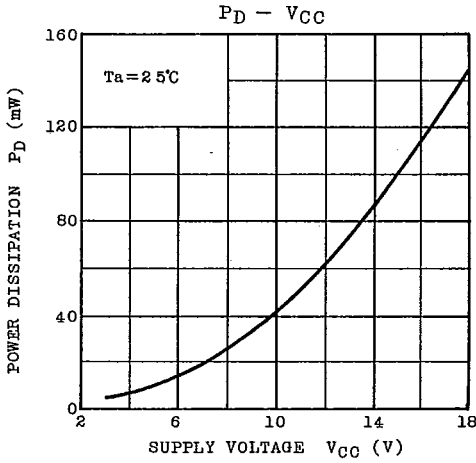

FREQUENCY CHARACTERISTICS OF OPEN LOOP GAIN

