

TA7641BP
TA7641BF

AM 1 CHIP RADIO

The TA7641BP is designed for the portable AM Radio applications and provides all of the functions from the converter to power amplifier. It is designed to make the quiescent current very small (1.6mA Typ. at $V_{CC}=3V$) by use of the idle current control circuit. So it is capable to design the portable radio set with merit that the battery life is very long.

- . Low Quiescent Current: $I_{CCQ}=1.6mA$ (Typ.) at $V_{CC}=3V$
- . Operating Supply Voltage Range: $V_{CC}=2 \sim 5V$
- . High Power Efficiency
- . Power Output: $P_O=100mW$ (Typ.) at THD=10%
- . The Item is Different Each Outlines.

TA7641BP; Dual in Line Package..Outline 3D16A-P

TA7641BF; Flat Package.....Outline F16GA1-P

Unit in mm

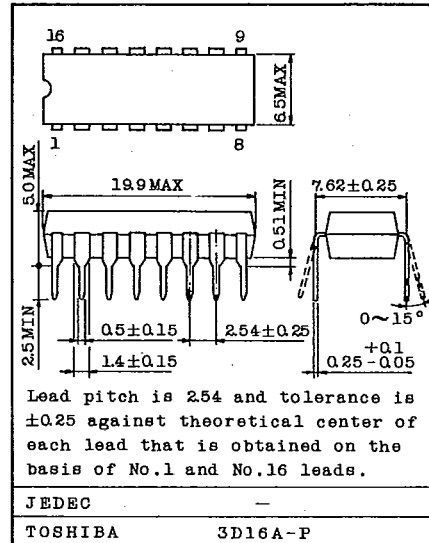

MAXIMUM RATINGS ($T_a=25^{\circ}C$)

CHARACTERISTIC	SYMBOL	RATING	UNIT
Supply Voltage	V_{CC}	6	V
Power Dissipation (Note)	TA7641BP	750	mW
	TA7641BF	350	
Output Current (Peak)	$I_O(\text{peak})$	0.2	A
Operating Temperature	T_{opr}	-10 ~ 60	$^{\circ}C$
Storage Temperature	T_{stg}	-55 ~ 150	$^{\circ}C$

Note: TA7641BP: Derated above $T_a=25^{\circ}C$ in the proportion of $6mW/^{\circ}C$.

TA7641BF: Derated above $T_a=25^{\circ}C$ in the proportion of $2.8mW/^{\circ}C$.

Unit in mm

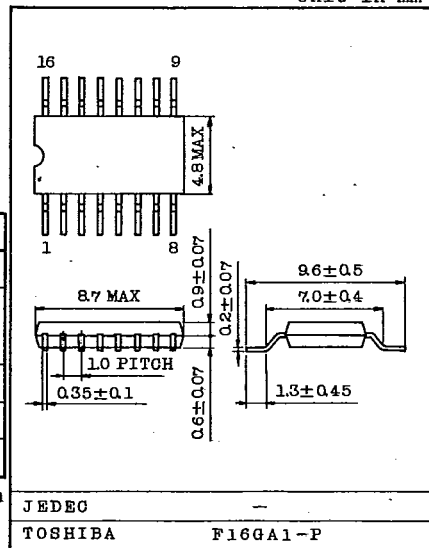

TA7641BP

TA7641BF

T-77-05-05

ELECTRICAL CHARACTERISTICS

(Unless otherwise specified,

 $V_{CC}=3V$, $f=1MHz$, $f_m=1kHz$, $Mod=30\%$, $R_g=50\Omega$, $R_L=8\Omega$, $T_a=25^\circ C$)

CHARACTERISTIC	SYMBOL	TEST CIRCUIT	TEST CONDITION	MIN.	TYP.	MAX.	UNIT
Quiescent Current	I_{CCQ}	1	$V_{IN}=0$	0.7	1.6	3.0	mA
Maximum Sensitivity	GSM	.1	$V_{IN}=20dB\mu V$, $V_R=Max.$	200	-	-	mV _{rms}
Output Power	P_o	1	$V_{IN}=42dB\mu V$, $V_R=Max.$ $R_L=8\Omega$	80	100	-	mW
Maximum Output Power	P_{OM}	1	Power Amp. Only	-	150	-	mW
Total Harmonic Distortion	THD	1	$V_{IN}=42dB\mu V$ $V_o=200mV_{rms}$ ($V_R=control$)	-	2	6	%
Signal to Noise Ratio	S/N	1	($V_R=control$)	-	44	-	dB
Output Noise Voltage	V_{NOISE}	1	$V_{IN}=0$, $V_R=Max.$	-	3.5	-	mV _{rms}
16 Pin Parallel Input Impedance	r_{ip} 16	2	$f=1MHz$	-	500	-	k Ω
	C_{ip} 16	2		-	2.5	-	pF
1 Pin Parallel Output Impedance	r_{op} 1	3	$f=1MHz$	-	500	-	k Ω
	C_{op} 1	3		-	3.9	-	pF
3 Pin Parallel Input Impedance	r_{ip} 3	4	$f=500kHz$	-	60	-	k Ω
	C_{ip} 3	4		-	2.2	-	pF
5 Pin Parallel Output Impedance	r_{op} 5	5	$f=500kHz$	-	100	-	k Ω
	C_{op} 5	5		-	3.0	-	pF

AUDIO LINEAR IC

TA7641BP
TA7641BF

T-77-05-05

COIL DATA

T₁ Antenna Coil

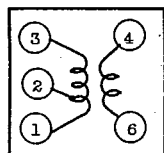

(Bottom View)

f (kHz)	L(μH)	Q ₀	Turns		
	1-3	1-3	1-2	2-3	4-6
300	600	115	2	130	8

TOKO
JA-1302 or Equivalent
Wire : 0.07mmφUEW

T₂ OSC Coil

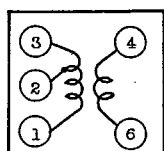

(Bottom View)

f (kHz)	L(μH)	Q ₀	Turns		
	1-3	1-3	1-2	2-3	4-6
796	360	125	92 $\frac{1}{2}$	8	10 $\frac{1}{2}$

SUMIDA
0187-145-092 or Equivalent
Wire : 0.08mmφUEW

T₃ AM IFT

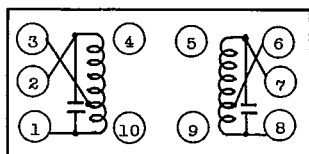

(Bottom View)

C ₀ (pF)	f (kHz)	Q ₀	Turns			
			1-2	1-3	2-3	6-7
150	455	65	80	148	196	32

SUMIDA
48-037-921 or Equivalent
Wire : 0.08mmφUEW

T₄ Detector Coil

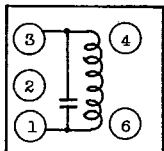

(Bottom View)

C ₀ (pF)	f (kHz)	Q ₀	Turns
		1-3	1-3
180	455	65	142

SUMIDA
0130-108-016 or Equivalent
Wire : 0.08mmφUEW

L₁ Bar Antenna

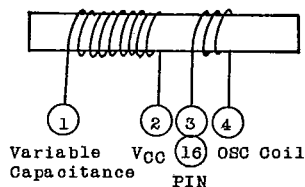

f (kHz)	L(μH)	Q ₀	Turns	
	1-2	1-2	1-2	3-4
796	625	200MIN	105	20

Core ; 12mmφ × 53mmφ
Wire ; USTC-0.1mmφ

TA7641BP
TA7641BF

T-77-05-05

TEST CIRCUIT

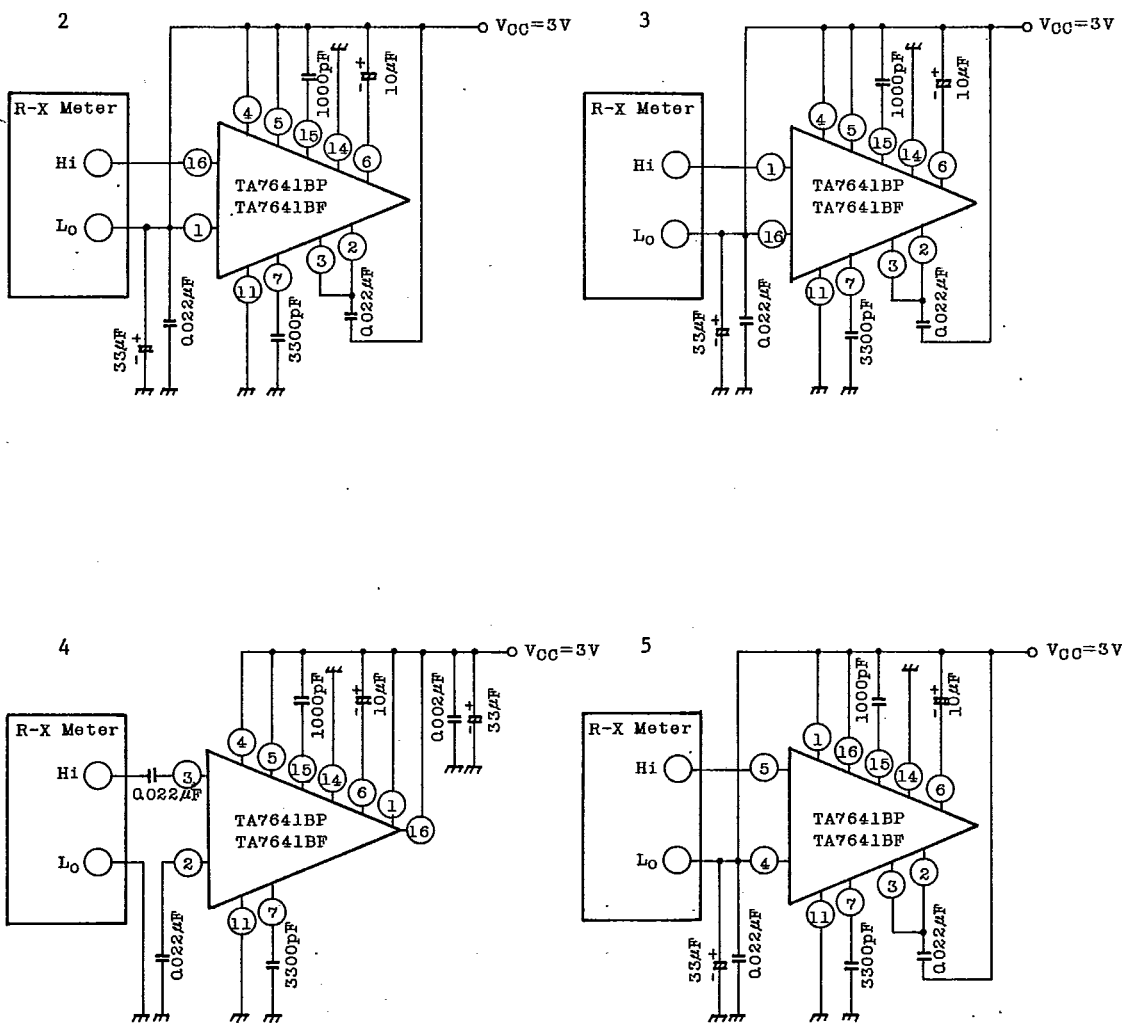

TOSHIBA

TA7641BP
TA7641BF

T-77-05-05

APPLICATION CIRCUIT

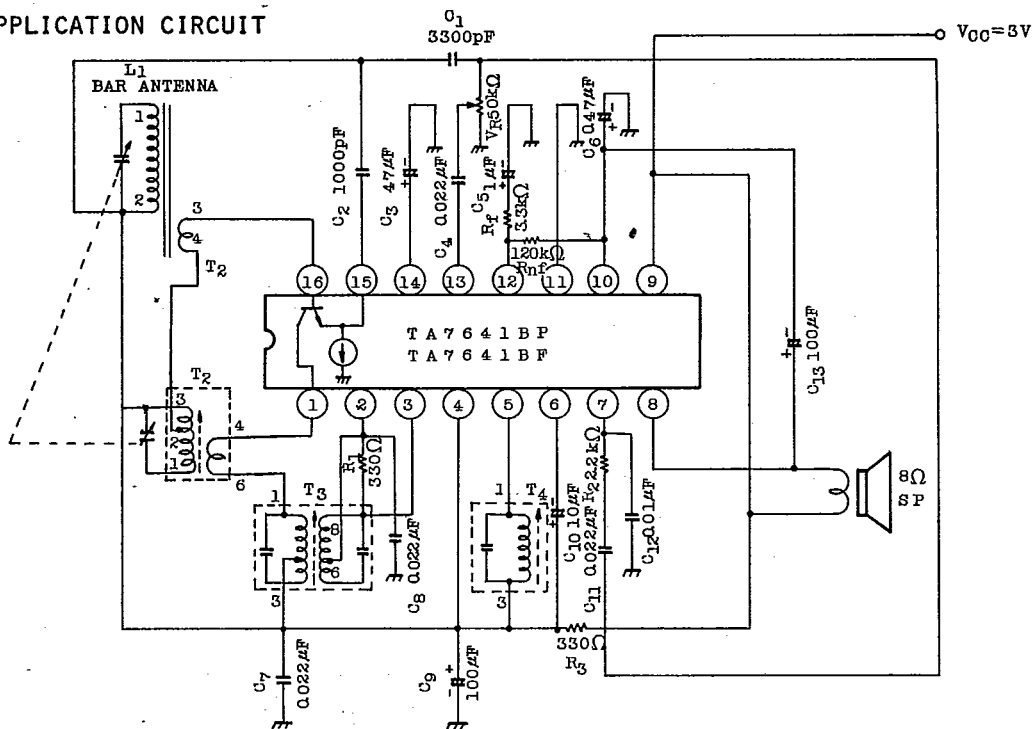

ELECTRICAL CHARACTERISTICS

(Unless otherwise specified $T_a=25^\circ\text{C}$, $V_{CC}=3\text{V}$, $f=1\text{MHz}$, $f_m=1\text{kHz}$, $\text{Mod.}=30\%$, $R_L=8\Omega$)

CHARACTERISTIC	SYMBOL	TEST CONDITION	TYP. VALUE	UNIT
Quiescent Current	I_{CCQ}	$E_{IN}=0\text{dB/m}$	1.6	mA
Maximum Sensitivity	MS	$P_O=5\text{mW}$	41	dB/m
Quieting Sensitivity	QS	$S/N=20\text{dB}$	49	dB/m
Signal to Noise Ratio	S/N	$E_{IN}=74\text{dB/m}$	44	dB
AGC Ratio (Note 1)	AGC (FOM)	-10dB Output Reduction (from 100dB/m)	50	dB
Recovered Output Voltage	VOD	$E_{IN}=74\text{dB/m}$, Measure Pin 7	131	mV_{RMS}
Power Amplifier Voltage Gain (Note 2)	G_V	$R_{nf}=120\text{k}\Omega$, $R_f=3.3\text{k}\Omega$	26	dB
Output Power	P_O	THD=10%	100	mW
Total Harmonic Distortion	THD	$E_{IN}=74\text{dB/m}$	2	%

Note 1. The AGC Ratio is defined as the input electric field intensity ratio between the output voltage at 100dB/m and -10dB output voltage.

2. The open loop voltage gain of the power amplifier is typical 33dB.

AUDIO LINEAR IC

TA7641BP
TA7641BF

T-77-05-05

$\eta - P_o$
CHARACTERISTIC COMPARISON

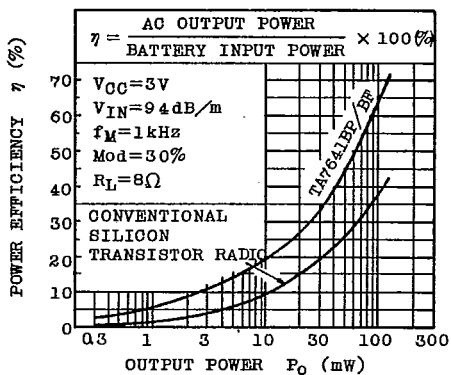

$P_D(\text{BATTERY}), I_{CC} - P_{OUT}$
CHARACTERISTIC COMPARISON

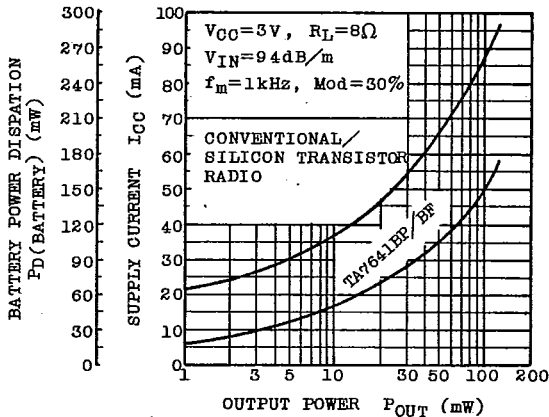

$V_{OUT}, S/N, THD - E_{FI}$

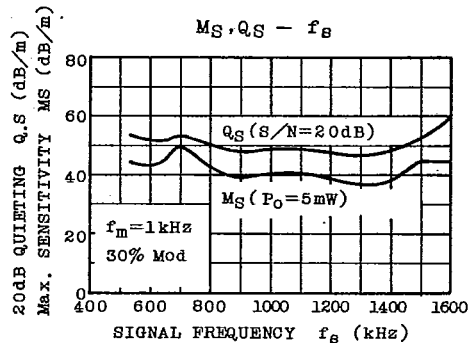
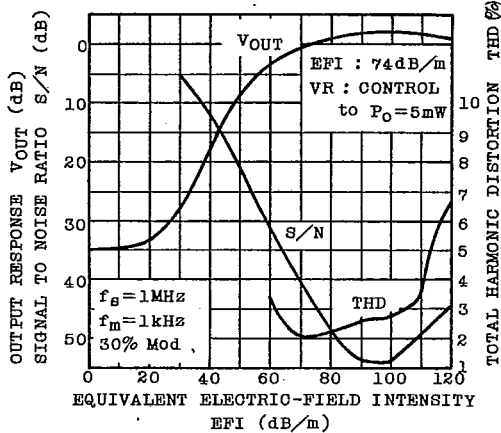

$V_{OD}, S/N, THD - E_{FI}$

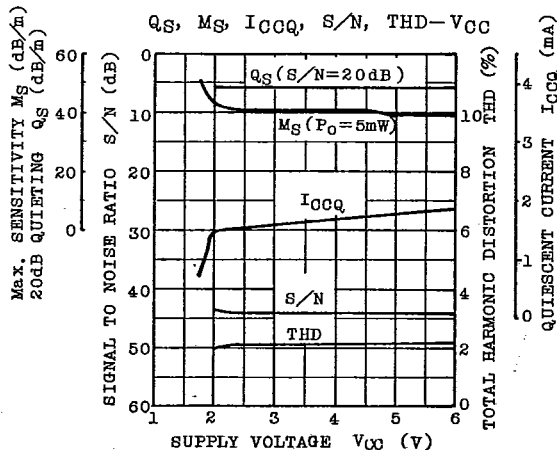
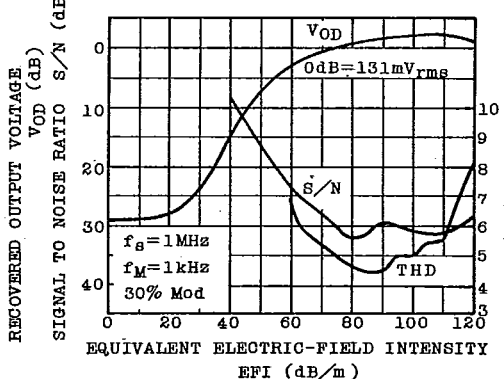

TOSHIBA

TA7641BP
TA7641BF
 T-77-05-05

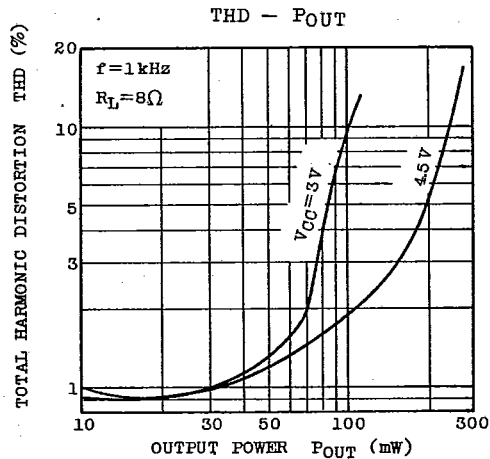
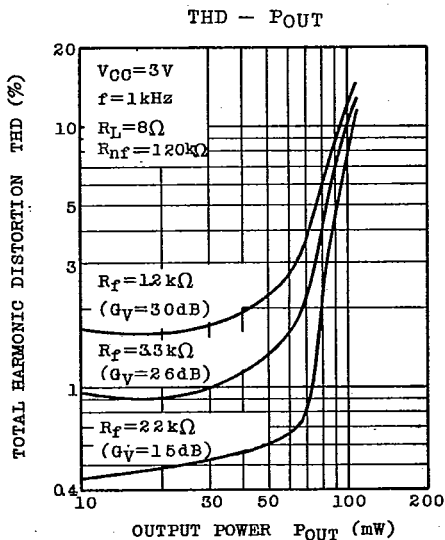
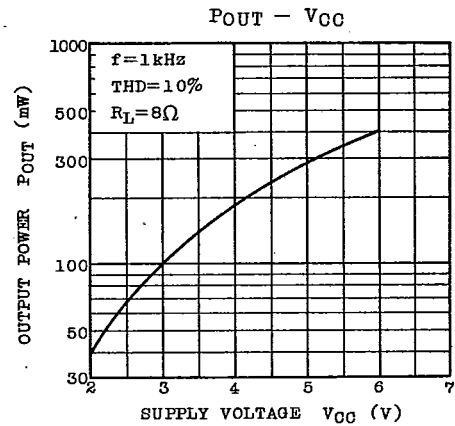
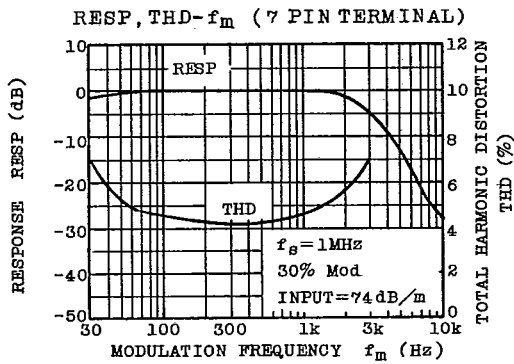
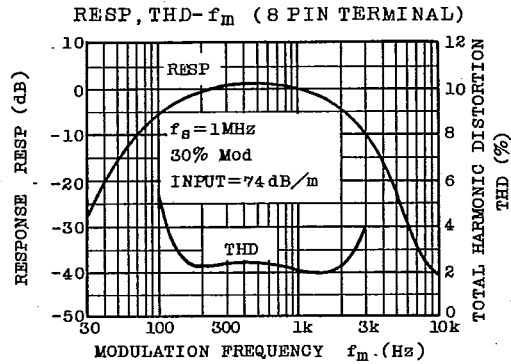
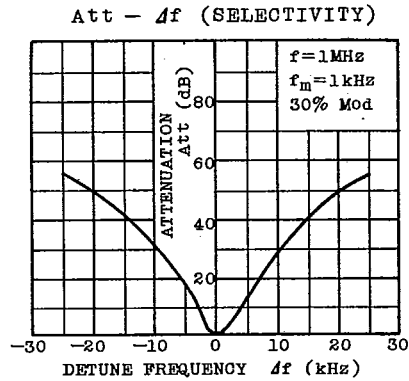

AUDIO LINEAR IC

1A/641BP
TA7641BF

T-77-05-05

