

TOSHIBA Bipolar Linear Integrated Circuit Silicon Monolithic

TA78DL05AS, TA78DL06AS, TA78DL08AS, TA78DL09AS, TA78DL10AS, TA78DL12AS, TA78DL15AS

5 V, 6 V, 8 V, 9 V, 10 V, 12 V, 15 V

Three-Terminal Low Dropout Voltage Regulator

The TA78DL××AS series consists of positive fixed output voltage regulator IC capable of sourcing current up to 250 mA. Due to the features of low dropout voltage and low standby current, these devices are useful for battery powered equipment. This series includes current limiting, thermal shutdown, overvoltage protection, input fault protection and excessive transient protection circuits internally.

Features

- Low standby current of 500 μ A typical.
- Maximum output current up to 250 mA.
- Low dropout voltage of less than 0.6 V (@ $I_{OUT} = 0.2$ A).
- Multi-protection:
Reverse connection of power supply, 60 V load dump, thermal shut down and current limiting.
- Metal fin (tab) is fully covered with mold resin. (TO-220 NIS package)

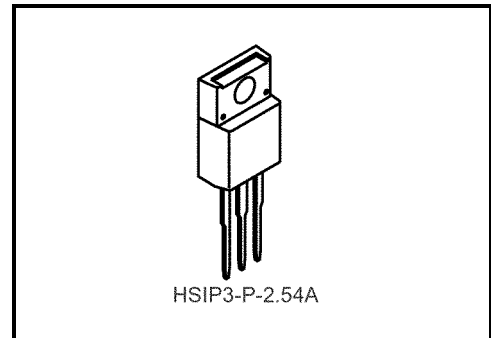

Weight: 1.7 g (typ.)

Pin Assignment

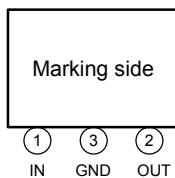

Block Diagram

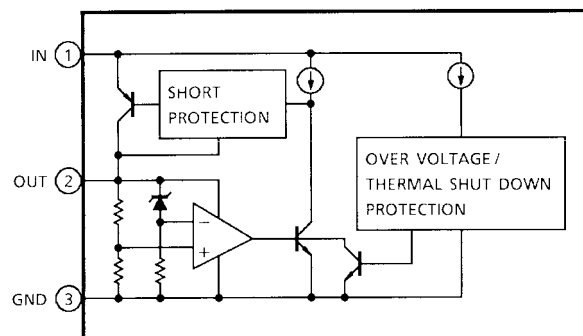

Maximum Ratings (Ta = 25°C)

Characteristics	Symbol	Rating	Unit
Operating input voltage	V _{IN}	29	V
Input voltage of surge	V _{IN}	60	V
Power dissipation	(Ta = 25°C)	2	W
	(Tc = 25°C)	20	
Operating temperature	T _{opr}	-40~85	°C
Storage temperature	T _{stg}	-55~150	°C
Junction temperature	T _j	150	°C
Thermal resistance	R _{th(j-c)}	6.25	°C/W
	R _{th(j-a)}	62.5	
Storage temperature-time	T _{sol}	260 (10s)	°C

TA78DL05AS

Electrical Characteristics (Unless otherwise specified, V_{IN} = 14 V, I_{OUT} = 10 mA, T_j = 25°C)

Characteristics	Symbol	Test Circuit	Test Condition	Min	Typ.	Max	Unit
Output voltage	V _{OUT}	—	5.35 V ≤ V _{IN} ≤ 26 V, -40°C ≤ Ta ≤ 85°C	4.75	5.0	5.25	V
Line regulation	Reg-line	—	9 V ≤ V _{IN} ≤ 16 V	—	2	10	mV
			6 V ≤ V _{IN} ≤ 26 V	—	4	30	
Load regulation	Reg-load	—	10 mA ≤ I _{OUT} ≤ 200 mA	—	14	50	mV
Quiescent current	I _B	—	I _{OUT} ≤ 10 mA, 6 V ≤ V _{IN} ≤ 26 V	—	0.5	1	mA
Dropout voltage	V _D	—	I _{OUT} = 50 mA	—	0.15	0.3	V
			I _{OUT} = 200 mA	—	0.4	0.6	
Max operating voltage	V _{IN}	—	—	29	33	—	V

TA78DL06AS

Electrical Characteristics (Unless otherwise specified, $V_{IN} = 14\text{ V}$, $I_{OUT} = 10\text{ mA}$, $T_j = 25^\circ\text{C}$)

Characteristics	Symbol	Test Circuit	Test Condition	Min	Typ.	Max	Unit
Output voltage	V_{OUT}	—	$6.35\text{ V} \leq V_{IN} \leq 26\text{ V}$, $-40^\circ\text{C} \leq T_a \leq 85^\circ\text{C}$	5.7	6.0	6.3	V
Line regulation	Reg.line	—	$10\text{ V} \leq V_{IN} \leq 17\text{ V}$	—	2	12	mV
			$7\text{ V} \leq V_{IN} \leq 26\text{ V}$	—	5	36	
Load regulation	Reg.load	—	$10\text{ mA} \leq I_{OUT} \leq 200\text{ mA}$	—	17	60	mV
Quiescent current	I_B	—	$I_{OUT} \leq 10\text{ mA}$, $7\text{ V} \leq V_{IN} \leq 26\text{ V}$	—	0.55	—	mA
Dropout voltage	V_D	—	$I_{OUT} = 50\text{ mA}$	—	0.15	0.3	V
			$I_{OUT} = 200\text{ mA}$	—	0.4	0.6	
Max operating voltage	V_{IN}	—	—	29	33	—	V

TA78DL08AS

Electrical Characteristics (Unless otherwise specified, $V_{IN} = 16\text{ V}$, $I_{OUT} = 10\text{ mA}$, $T_j = 25^\circ\text{C}$)

Characteristics	Symbol	Test Circuit	Test Condition	Min	Typ.	Max	Unit
Output voltage	V_{OUT}	—	$8.35\text{ V} \leq V_{IN} \leq 26\text{ V}$, $-40^\circ\text{C} \leq T_a \leq 85^\circ\text{C}$	7.6	8	8.4	V
Line regulation	Reg.line	—	$12\text{ V} \leq V_{IN} \leq 19\text{ V}$	—	3	16	mV
			$9\text{ V} \leq V_{IN} \leq 26\text{ V}$	—	6	45	
Load regulation	Reg.load	—	$10\text{ mA} \leq I_{OUT} \leq 200\text{ mA}$	—	22	80	mV
Quiescent current	I_B	—	$I_{OUT} \leq 10\text{ mA}$, $9\text{ V} \leq V_{IN} \leq 26\text{ V}$	—	0.6	—	mA
Dropout voltage	V_D	—	$I_{OUT} = 50\text{ mA}$	—	0.15	0.3	V
			$I_{OUT} = 200\text{ mA}$	—	0.4	0.6	
Max operating voltage	V_{IN}	—	—	29	33	—	V

TA78DL09AS

Electrical Characteristics (Unless otherwise specified, $V_{IN} = 16\text{ V}$, $I_{OUT} = 10\text{ mA}$, $T_j = 25^\circ\text{C}$)

Characteristics	Symbol	Test Circuit	Test Condition	Min	Typ.	Max	Unit
Output voltage	V_{OUT}	—	$9.35\text{ V} \leq V_{IN} \leq 26\text{ V}$, $-40^\circ\text{C} \leq T_a \leq 85^\circ\text{C}$	8.55	9	9.45	V
Line regulation	Reg.line	—	$13\text{ V} \leq V_{IN} \leq 20\text{ V}$	—	3	18	mV
			$10\text{ V} \leq V_{IN} \leq 26\text{ V}$	—	7	50	
Load regulation	Reg.load	—	$10\text{ mA} \leq I_{OUT} \leq 200\text{ mA}$	—	25	90	mV
Quiescent current	I_B	—	$I_{OUT} \leq 10\text{ mA}$, $10\text{ V} \leq V_{IN} \leq 26\text{ V}$	—	0.65	—	mA
Dropout voltage	V_D	—	$I_{OUT} = 50\text{ mA}$	—	0.15	0.3	V
			$I_{OUT} = 200\text{ mA}$	—	0.4	0.6	
Max operating voltage	V_{IN}	—	—	29	33	—	V

TA78DL10AS

Electrical Characteristics (Unless otherwise specified, $V_{IN} = 16\text{ V}$, $I_{OUT} = 10\text{ mA}$, $T_j = 25^\circ\text{C}$)

Characteristics	Symbol	Test Circuit	Test Condition	Min	Typ.	Max	Unit
Output voltage	V_{OUT}	—	$10.35\text{ V} \leq V_{IN} \leq 26\text{ V}$, $-40^\circ\text{C} \leq T_a \leq 85^\circ\text{C}$	9.5	10	10.5	V
Line regulation	Reg·line	—	$14\text{ V} \leq V_{IN} \leq 21\text{ V}$	—	4	20	mV
			$11\text{ V} \leq V_{IN} \leq 26\text{ V}$	—	8	60	
Load regulation	Reg·load	—	$10\text{ mA} \leq I_{OUT} \leq 200\text{ mA}$	—	28	100	mV
Quiescent current	I_B	—	$I_{OUT} \leq 10\text{ mA}$, $11\text{ V} \leq V_{IN} \leq 26\text{ V}$	—	0.7	—	mA
Dropout voltage	V_D	—	$I_{OUT} = 50\text{ mA}$	—	0.15	0.3	V
			$I_{OUT} = 200\text{ mA}$	—	0.4	0.6	
Max operating voltage	V_{IN}	—	—	29	33	—	V

TA78DL12AS

Electrical Characteristics (Unless otherwise specified, $V_{IN} = 18\text{ V}$, $I_{OUT} = 10\text{ mA}$, $T_j = 25^\circ\text{C}$)

Characteristics	Symbol	Test Circuit	Test Condition	Min	Typ.	Max	Unit
Output voltage	V_{OUT}	—	$12.35\text{ V} \leq V_{IN} \leq 26\text{ V}$, $-40^\circ\text{C} \leq T_a \leq 85^\circ\text{C}$	11.4	12	12.6	V
Line regulation	Reg·line	—	$16\text{ V} \leq V_{IN} \leq 23\text{ V}$	—	5	24	mV
			$13\text{ V} \leq V_{IN} \leq 26\text{ V}$	—	10	70	
Load regulation	Reg·load	—	$10\text{ mA} \leq I_{OUT} \leq 200\text{ mA}$	—	33	120	mV
Quiescent current	I_B	—	$I_{OUT} \leq 10\text{ mA}$, $13\text{ V} \leq V_{IN} \leq 26\text{ V}$	—	0.8	—	mA
Dropout voltage	V_D	—	$I_{OUT} = 50\text{ mA}$	—	0.15	0.3	V
			$I_{OUT} = 200\text{ mA}$	—	0.4	0.6	
Max operating voltage	V_{IN}	—	—	29	33	—	V

TA78DL15AS

Electrical Characteristics (Unless otherwise specified, $V_{IN} = 20\text{ V}$, $I_{OUT} = 10\text{ mA}$, $T_j = 25^\circ\text{C}$)

Characteristics	Symbol	Test Circuit	Test Condition	Min	Typ.	Max	Unit
Output voltage	V_{OUT}	—	$15.35\text{ V} \leq V_{IN} \leq 26\text{ V}$, $-40^\circ\text{C} \leq T_a \leq 85^\circ\text{C}$	14.25	15	15.75	V
Line regulation	Reg·line	—	$19\text{ V} \leq V_{IN} \leq 26\text{ V}$	—	6	30	mV
			$16\text{ V} \leq V_{IN} \leq 26\text{ V}$	—	12	80	
Load regulation	Reg·load	—	$10\text{ mA} \leq I_{OUT} \leq 200\text{ mA}$	—	40	150	mV
Quiescent current	I_B	—	$I_{OUT} \leq 10\text{ mA}$, $16\text{ V} \leq V_{IN} \leq 26\text{ V}$	—	0.9	—	mA
Dropout voltage	V_D	—	$I_{OUT} = 50\text{ mA}$	—	0.15	0.3	V
			$I_{OUT} = 200\text{ mA}$	—	0.4	0.6	
Max operating voltage	V_{IN}	—	—	29	33	—	V

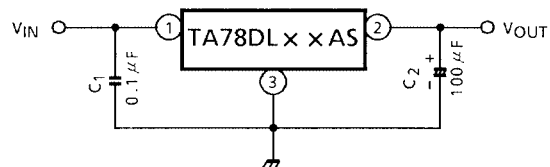
Application Circuit

Capacitor C_{IN}/C_{OUT} must be guaranteed to operate of the temperature range that the regulator should be operated correctly.

The equivalent series resistance (ESR) of C_{OUT} must be less than 1 Ω in operating temperature range.

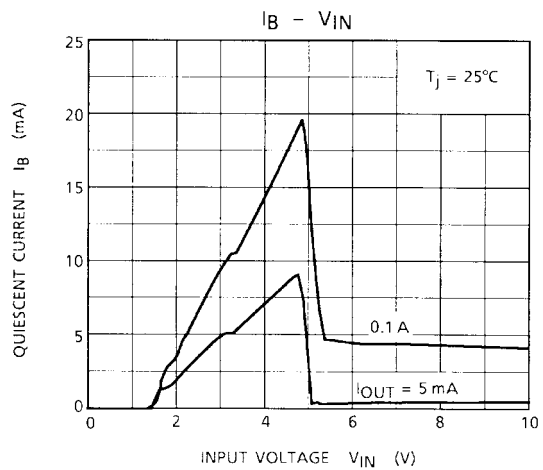
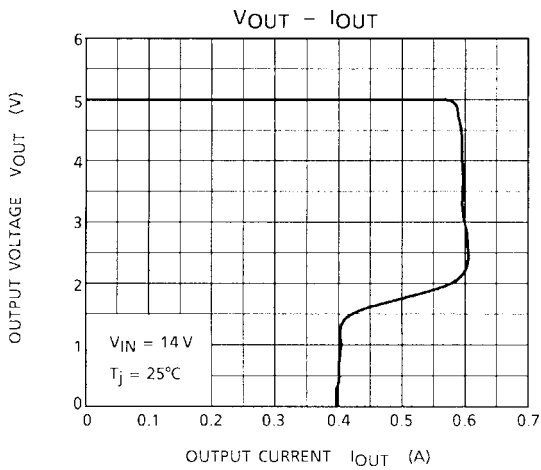
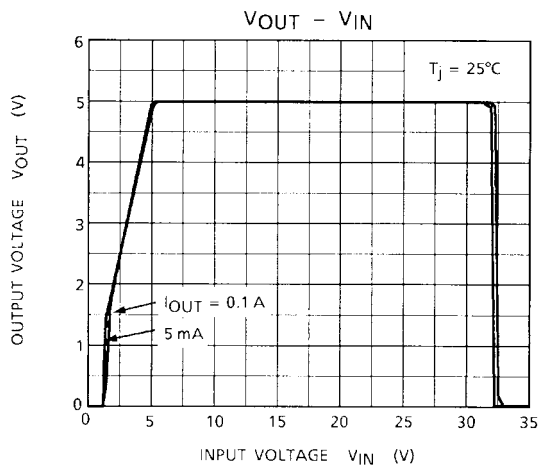
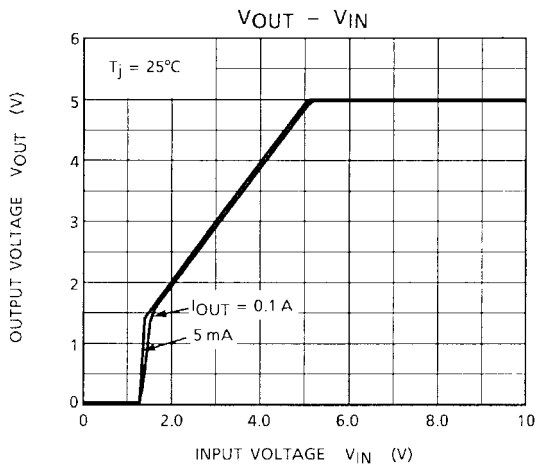
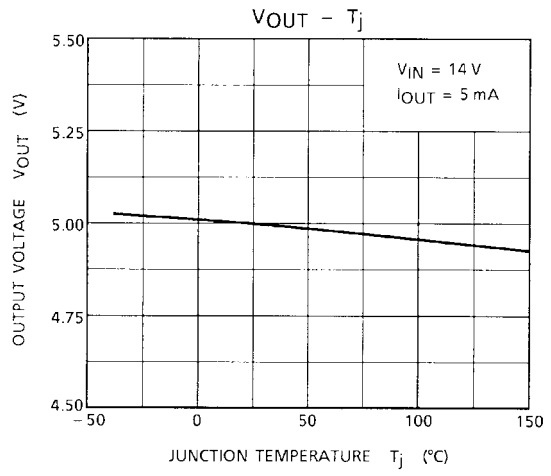
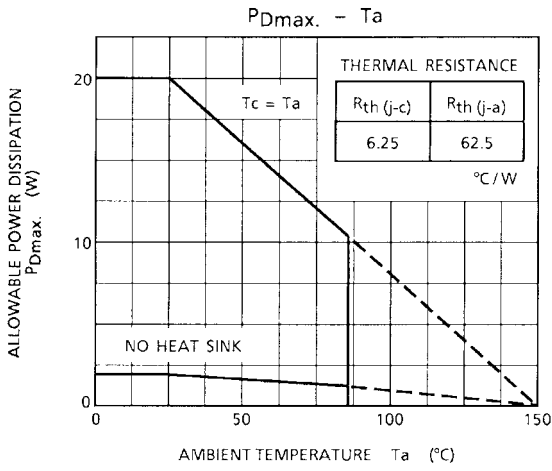

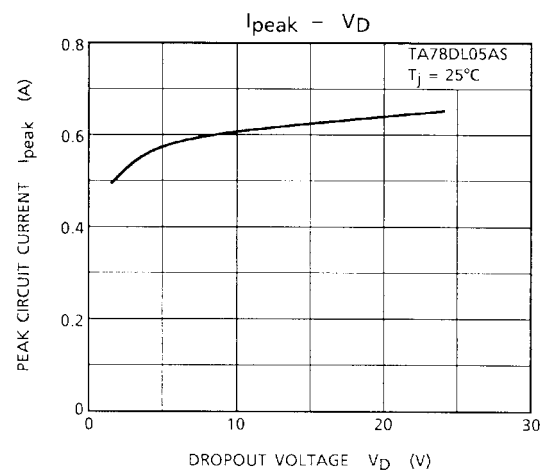
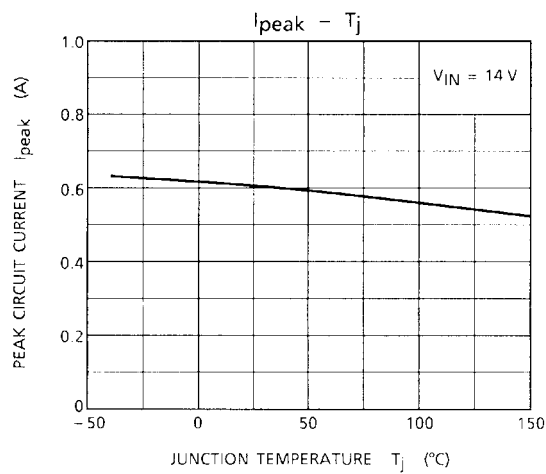
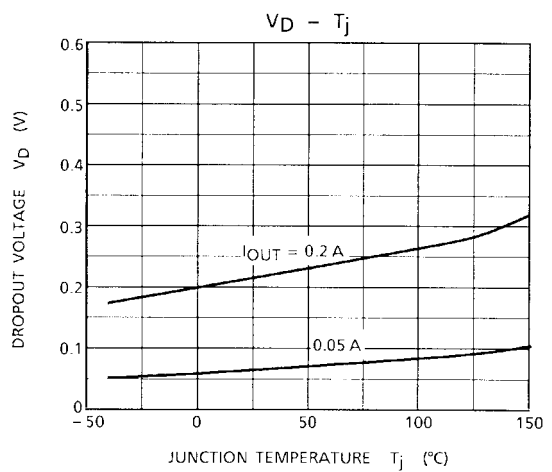
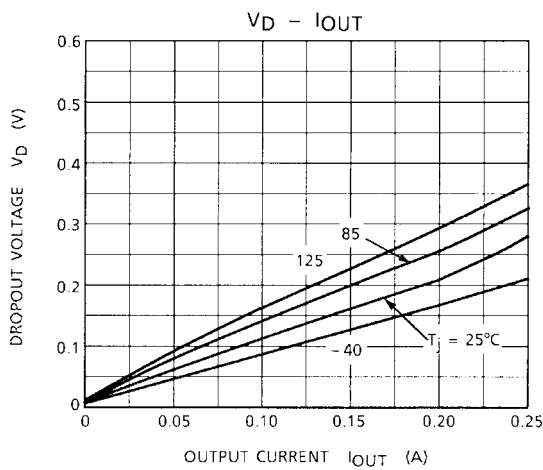
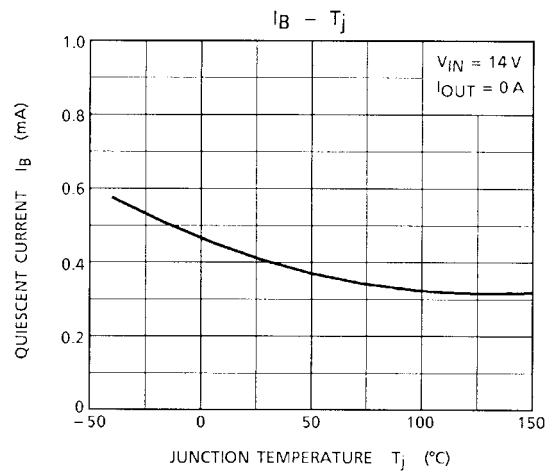
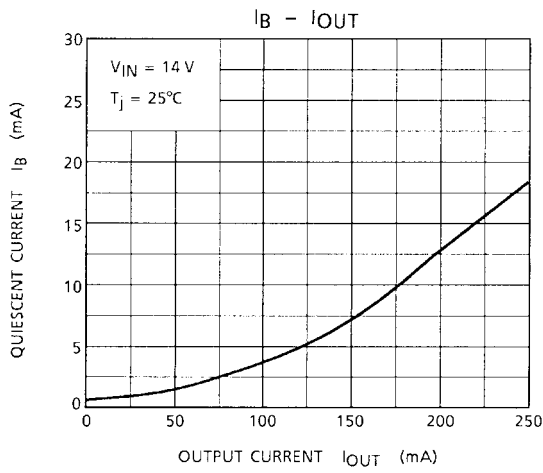

Package Dimensions

HSIP3-P-2.54A

Unit: mm

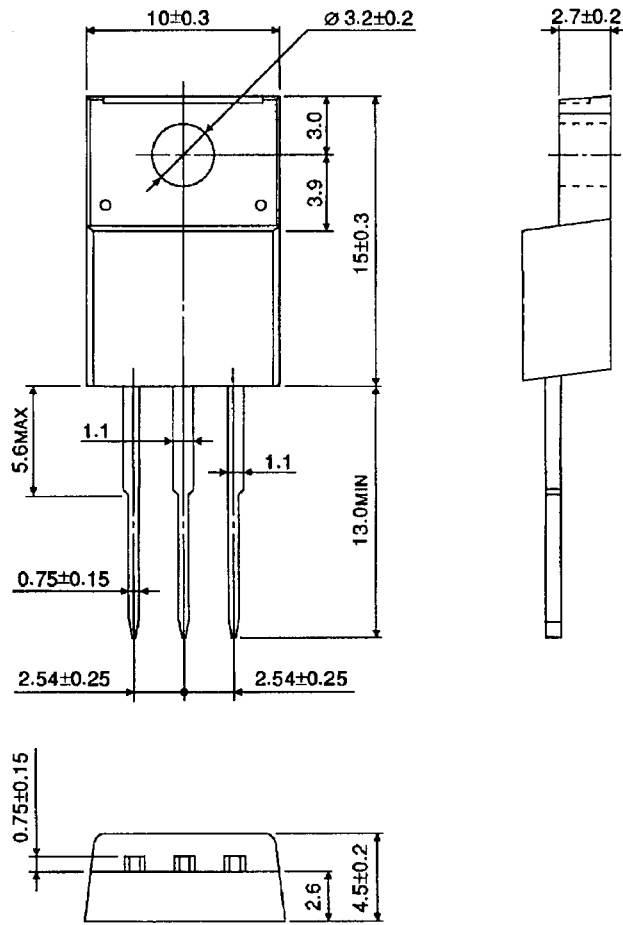

Weight: 1.7 g (typ.)

RESTRICTIONS ON PRODUCT USE

000707EBA

- TOSHIBA is continually working to improve the quality and reliability of its products. Nevertheless, semiconductor devices in general can malfunction or fail due to their inherent electrical sensitivity and vulnerability to physical stress. It is the responsibility of the buyer, when utilizing TOSHIBA products, to comply with the standards of safety in making a safe design for the entire system, and to avoid situations in which a malfunction or failure of such TOSHIBA products could cause loss of human life, bodily injury or damage to property.
In developing your designs, please ensure that TOSHIBA products are used within specified operating ranges as set forth in the most recent TOSHIBA products specifications. Also, please keep in mind the precautions and conditions set forth in the "Handling Guide for Semiconductor Devices," or "TOSHIBA Semiconductor Reliability Handbook" etc..
- The TOSHIBA products listed in this document are intended for usage in general electronics applications (computer, personal equipment, office equipment, measuring equipment, industrial robotics, domestic appliances, etc.). These TOSHIBA products are neither intended nor warranted for usage in equipment that requires extraordinarily high quality and/or reliability or a malfunction or failure of which may cause loss of human life or bodily injury ("Unintended Usage"). Unintended Usage include atomic energy control instruments, airplane or spaceship instruments, transportation instruments, traffic signal instruments, combustion control instruments, medical instruments, all types of safety devices, etc.. Unintended Usage of TOSHIBA products listed in this document shall be made at the customer's own risk.
- The products described in this document are subject to the foreign exchange and foreign trade laws.
- The information contained herein is presented only as a guide for the applications of our products. No responsibility is assumed by TOSHIBA CORPORATION for any infringements of intellectual property or other rights of the third parties which may result from its use. No license is granted by implication or otherwise under any intellectual property or other rights of TOSHIBA CORPORATION or others.
- The information contained herein is subject to change without notice.