

TA8006ASN

5V VOLTAGE REGULATOR WITH WATCHDOG TIMER

The TA8006ASN is an IC specially designed for microcomputer systems. It incorporates a highly accurate constant-voltage power supply ($5\pm 0.1V$) and various system reset functions. For system reset, it monitors two voltages-88% and 96% of V_{REG} -and has a watchdog timer which can self-diagnose the microcomputer system so that program runaway can be prevented. It also has an over-voltage protection function and a current limiter. Since its standby current is as small as 0.7mA (Max.), it can be connected directly to an automotive battery.

FEATURES

- Accurate output : $5\pm 0.1V$ ($T_a = 25^\circ C$)
- Low standby current : 0.7mA (max.)
- Watchdog timer and power-on reset timer incorporated : \overline{RESET} , \overline{RESET} , \overline{WI}
- Current limiter and over-voltage protection circuit incorporated.
- Wide operating voltage range : 40V (max.)
- Wide operating temperature : $-40\sim 105^\circ C$
- Small shrink SIP-12pin.

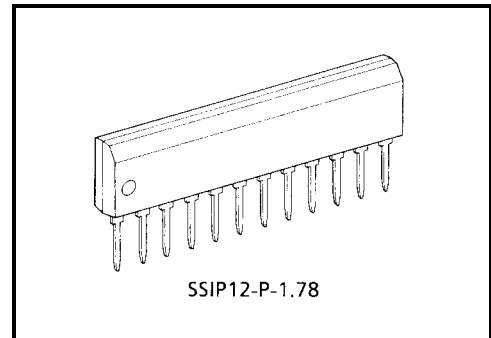

Weight: 0.71 g (typ.)

BLOCK DIAGRAM AND PIN LAYOUT

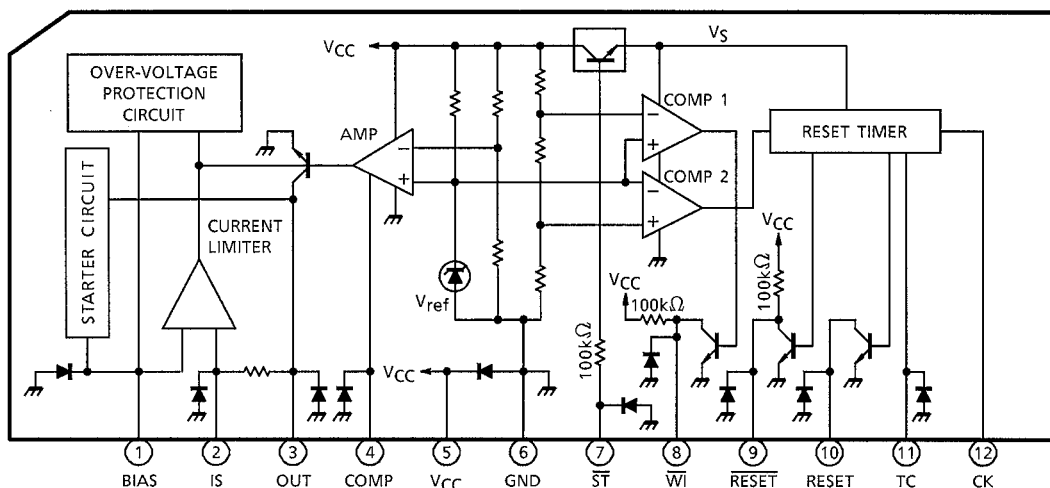

PIN DESCRIPTION

PIN No.	SYMBOL	DESCRIPTION
1	BIAS	Power supply pin for the current limiter, the over-voltage detector, the startup circuit which turns on 5V power.
2	IS	Detection pin for the current limiter. The voltage drop across external detection resistor R_S between pins 1 and 2 is monitored. A voltage exceeding 0.3V activates the current limiter. Example : If the load current 300mA, the value of R_S is $0.3V / 300mA = 1\Omega$
3	OUT	Connected to the base of an external PNP transistor so that the output voltage is stabilized. Power supply design suitable for particular load capacities is thus possible. Since the recommended maximum I_{OUT} is 5mA, an output current of 300mA is assured if the external transistor has an h_{FE} of 60 or more.
4	COMP	Phase compensation pin for output stabilization.
5	V_{CC}	Power supply pin for the power supply and the reset timer. The output voltage V_{REG} is also detected.
6	GND	Grounded.
7	\overline{ST}	Standby mode setup pin. When the signal is low, the system is in standby mode in which the reset timer is off and the power current is limited to 0.7mA or less. When the signal is high, the system is in active mode in which the power supply and reset timer are active.
8	\overline{WI}	Reset detect voltage V_{TH1} output pin. The reset detect voltage has a hysteresis of 0.2V. It is the output from the collector of an NPN transistor with a pull-up resistor.
9	\overline{RESET}	Watchdog timer reset pin. - Generates a reset signal which is determined by the CR combination of the TC pin. - Intermittently generates reset pulses if no clock is supplied to the CK pin. The \overline{RESET} signal is the output from the collector of an NPN transistor with a pull-up resistor.
10	RESET	Output pin of the inversion of pin 9 ($\overline{\overline{RESET}}$). It is the open-collector output of an NPN transistor.
11	TC	Pin for setting a time for the reset timer and watchdog timer. It connects to a resistor R_T which leads to V_{CC} and a capacitor C_T which is grounded.
12	CK	Clock input pin for the watchdog timer. If it is used for a power-on reset timer only, it is pulled up to V_{CC} .

Functional Description

The TA8006ASN incorporates a constant-voltage 5V power supply function to feed stable power to the CPU and a system reset function to ensure stable operation of the CPU, etc. These functions are explained below.

(1) Constant-voltage 5V power supply function

This constant-voltage function has the reference voltage V_{ref} in the IC that is insusceptible to temperature changes and input voltage fluctuations. The power supply circuit is designed in such a way that this voltage is stepped up to 5V by using an OP amp and a voltage-dividing resistor. These OP amp and dividing resistor and an output transistor connected to the OP amp output together configure a closed loop.

An overcurrent protection function is incorporated as a protective measure in case a fault such as shorting to GND occurs in the 5V output. A current detecting resistor is inserted between the BIAS and the IS pins, and a voltage drop across this resistor is detected by a comparator, thereby suppressing the operation of the OP amp to ensure that the voltage drop will not exceed 0.3V. In this way, a current limiter function is actuated to prevent no more current from flowing.

If you are using only the reset timer and not the constant-voltage 5V power supply function, connect the BIAS, IS, OUT, and COMP pins to GND.

(2) System reset function (See Timing Chart)

- Voltage monitoring function (1)

When powered on, the power-on reset timer starts counting the moment the voltage V_{CC} applied to the CPU exceeds 4.4V. When powered off, this voltage monitoring function outputs a reset signal immediately when V_{CC} drops below 4.4V. A reset signal also is output immediately when V_{CC} drops for some reason during normal operation. Then, when V_{CC} is restored to the normal voltage and exceeds 4.4V, the power-on reset timer starts counting.

The reset signal is output from the $\overline{\text{RESET}}$ pin and from its inverted output pin, RESET.

- Voltage monitoring function (2)

The $\overline{\text{WI}}$ pin outputs a high when the V_{CC} voltage increases above 4.8V and outputs a low when the V_{CC} voltage drops below 4.6V. This function only monitors the voltage, operating independently of the voltage monitoring function (1) and the reset timer function. At power-up, the $\overline{\text{WI}}$ output is inverted after the application system is released from reset; at power-down, the $\overline{\text{WI}}$ output is inverted before a reset is output. Therefore, this function can be used for memory write inhibit or similar other purposes.

- Power-on reset timer function

To allow the 5V constant voltage to stabilize at power-on, as well as provide a sufficient time for the clock oscillation in the CPU to stabilize, the device remains reset for a predetermined time before being released from the reset state. The duration of this time can be set as desired by choosing appropriate values for the external resistor and capacitor connected to the TC pin.

The system starts charging the capacitor when the V_{CC} voltage exceeds 4.4V. When this charge voltage exceeds 4V, the capacitor is discharged by the IC's internal transistor. When the capacitor is discharged down to 2V, the reset signal is inverted to deactivate the reset.

- Watchdog timer function

Program your system to output a clock each time one program routine is finished in the CPU system software, and input this clock to the CK pin of the IC. The IC's TC pin is repeatedly charged and discharged between 2V and 4V. However, when a clock is input, it switches over and starts discharging in the middle of charging and then starts charging from 2V again. Since the clock is generated at predetermined intervals when the CPU system is operating normally, the TC pin switches over and starts discharging before the charge voltage reaches 4V. However, if no clock is input while being charged from 2V to 4V, the clock is assumed to have stopped, i.e., the CPU system has gone wild, so that a reset signal is output to reset the CPU system.

The IC's CK pin is connected to the CPU system with a differential circuit. This is to ensure that when an erratic condition occurs in the CPU system, a low signal is always input to the CK pin regardless of whether the clock output from the CPU has stopped in the high or low state. When the CK pin is fixed high, no reset signal is output, in which case only the power-on reset timer is useful.

(3) Standby function

When the application system is in a standby (sleep) state, its operating current can be minimized by keeping only the IC's constant-voltage 5V output active and turning the entire reset function off. The low-current mode (standby) is entered by pulling the \overline{ST} pin low. In this mode, the voltage monitor functions (1) and (2) and the reset timer all are turned off while \overline{RESET} , RESET, and \overline{WI} all are fixed high.

TIMING CHART

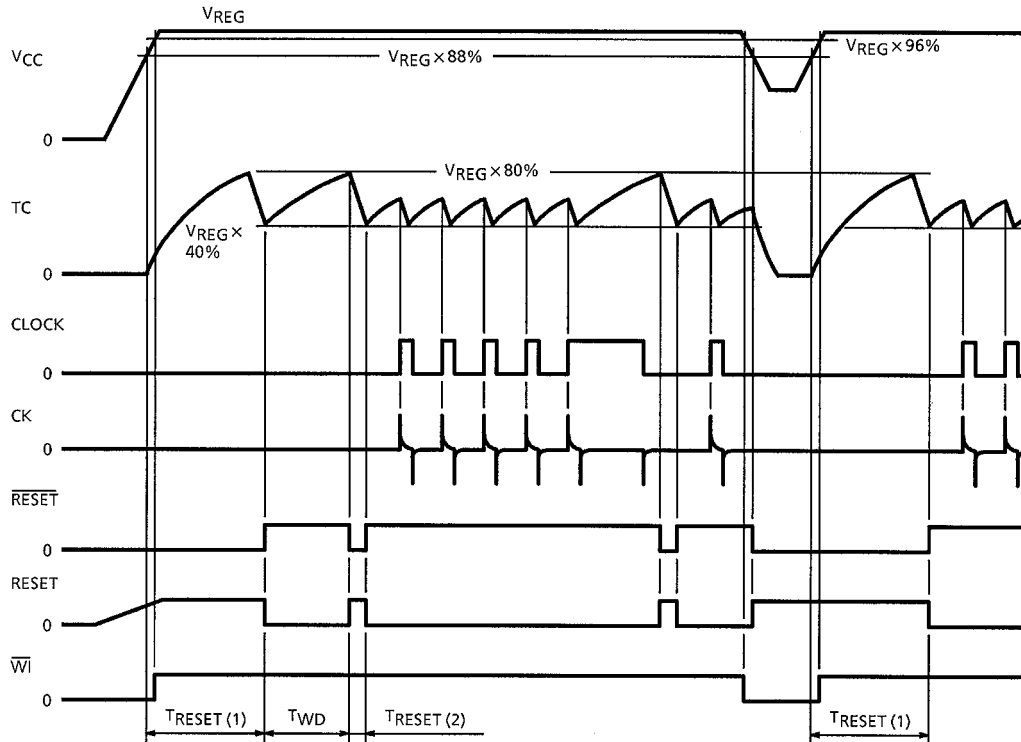

Note: TRESET(1), TRESET(2), TWD : See Electrical Characteristics.

MAXIMUM RATINGS (Ta = 25°C)

CHARACTERISTIC	SYMBOL	PIN	RATING	UNIT
Input Voltage	V _{IN1}	BIAS, IS	60 (1s)	V
	V _{IN2}	CK	-5~V _{CC}	
	V _{IN3}	\overline{ST}	-0.5~V _{IN}	
Output Current	I _{OUT1}	OUT	10	mA
	I _{OUT2}	RESET, \overline{RESET} , \overline{WI}	2	
Output Voltage	V _{OUT1}	OUT	60 (1s)	V
	V _{OUT2}	RESET	16	
Power Dissipation	P _D	—	500	mW
Operating Temperature	T _{opr}	—	-40~105	°C
Storage Temperature	T _{stg}	—	-55~150	°C
Lead Temperature time	T _{sol}	—	260 (10s)	°C

ELECTRICAL CHARACTERISTICS ($V_{IN} = 6\sim 18V$, $I_{LOAD} = 10mA$, $T_a = -40\sim 105^{\circ}C$)

CHARACTERISTIC	SYMBOL	PIN	TEST CIRCUIT	TEST CONDITION	MIN	TYP.	MAX	UNIT
Output Voltage	V_{REG}	V_{CC}	—	$T_a = 25^{\circ}C$	4.90	5.0	5.10	V
				$T_a = -40\sim 105^{\circ}C$	4.85	5.0	5.15	
Line Regulation		V_{CC}	—	$V_{IN} = 5.5\sim 40V$	—	0.1	0.5	%
Load Regulation		V_{CC}	—	$I_{LOAD} = 1\sim 50mA$	—	0.1	0.5	%
Temperature Coefficient		V_{CC}	—		—	0.01	—	% / $^{\circ}C$
Input Current	I_{IN}	\overline{ST}	—	$V_{IN} = 5V$	—	40	80	μA
Input Voltage	V_{IH}	\overline{ST}	—		2	—	—	V
	V_{IL}				—	—	0.3	
Output Voltage	V_{OL}	$\overline{RESET}, \overline{RESET}, \overline{WI}$	—	$I_{OL} = 1mA$	—	—	0.5	V
Output Leakage Current	I_{LEAK}	RESET	—	$V_{OUT} = 10V$	—	—	5	μA
Input Current	I_{IN}	TC	—	$V_{IN} = 0\sim 3.5V$	-3	—	3	μA
Threshold Voltage	V_{IH}	TC	—		—	$V_{REG} \times 80\%$	—	V
	V_{IL}				—	$V_{REG} \times 40\%$	—	
Input Current	I_{IN}	CK	—	$V_{IN} = 5V$	—	0.17	0.35	mA
Input Voltage	V_{IH}	CK	—		2	—	—	V
	V_{IL}				—	—	0.5	
Reset Detect Voltage	V_{TH1}	V_{CC}	—		$V_{REG} \times 94\%$	$V_{REG} \times 96\%$	$V_{REG} \times 98\%$	V
	V_{TH2}				$V_{REG} \times 85\%$	$V_{REG} \times 88\%$	$V_{REG} \times 91\%$	
Standby Current	I_{ST}	V_{CC}	—	$V_{IN} = 14V$ $\overline{ST} = "L"$	—	0.3	0.7	mA
Power Supply Current	I_{CC}	V_{CC}	—	$V_{IN} = 14V$ $\overline{ST} = V_{CC}$	—	0.9	1.8	mA
Current Limiter Detection	V_{LMT}	IS	—		—	0.3	—	V
Over-voltage Detection	V_{SD}	BIAS	—		—	43	—	V
Watchdog Timer	T_{WD}	RESET / RESET	—		$0.9 \times C_T R_T$	$1.1 \times C_T R_T$	$1.3 \times C_T R_T$	ms
Reset Timer (1)	$T_{RESET(1)}$				$1.3 \times C_T R_T$	$1.6 \times C_T R_T$	$1.9 \times C_T R_T$	
Reset Timer (2)	$T_{RESET(2)}$				$0.3 \times C_T$	$0.7 \times C_T$	$1.5 \times C_T$	
Clock Pulse Width	T_W	CK	—		3	—	—	μs

Note : The unit for C_T is μF , the unit for R_T is $k\Omega$.

TYPICAL CHARACTERISTICS

INPUT-OUTPUT CHARACTERISTICS

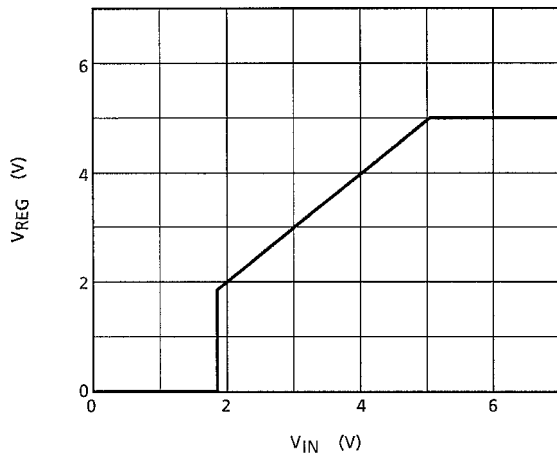

RESET OUTPUT CHARACTERISTICS (\overline{WI})

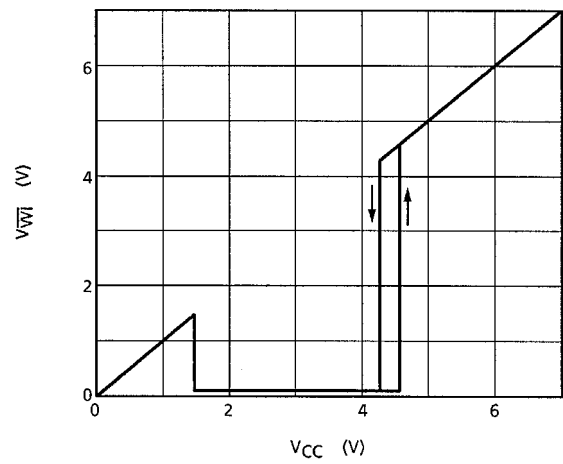

RESET OUTPUT CHARACTERISTICS (\overline{RESET})

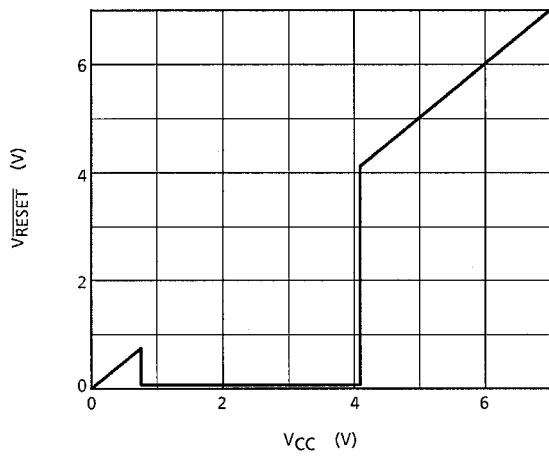

RESET OUTPUT CHARACTERISTICS (\overline{RESET})

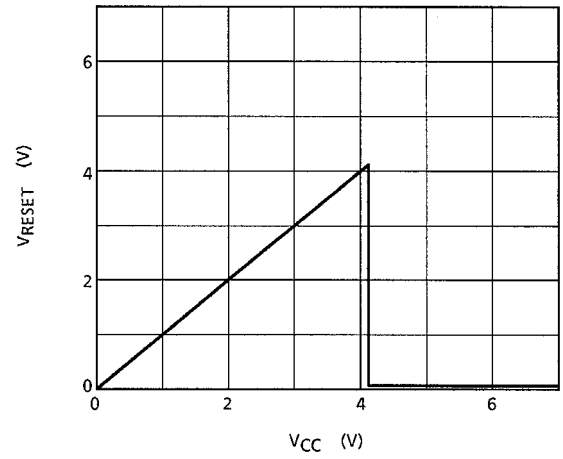

EXAMPLE OF APPLICATION CIRCUIT

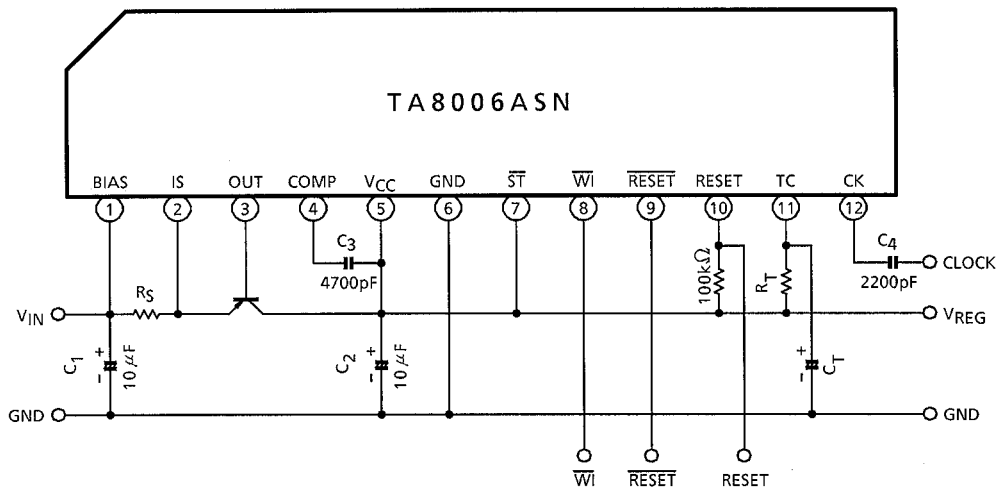

***: Cautions for Wiring**

1. C_1 and C_2 are for absorbing disturbance, noise, etc. Connect them as close to the IC as possible.
2. C_3 is for phase compensation. Also, connect C_3 close to the IC.

Recommended Conditions

PART NAME	MIN	MAX	UNIT
C_T	0.01	100	μ F
R_T	5	100	k Ω

CK INPUT APPLICATION CIRCUIT

Capacitor Coupling

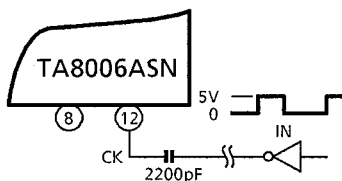

Timing Chart

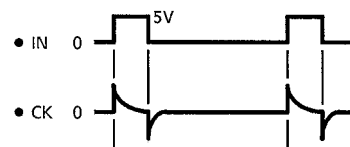

The capacitor coupling allows reset pulses to be supplied intermittently from the \overline{RESET} pin whether the input level (IN) is high or low.

PACKAGE DIMENSIONS

SSIP12-P-1.78

Unit : mm

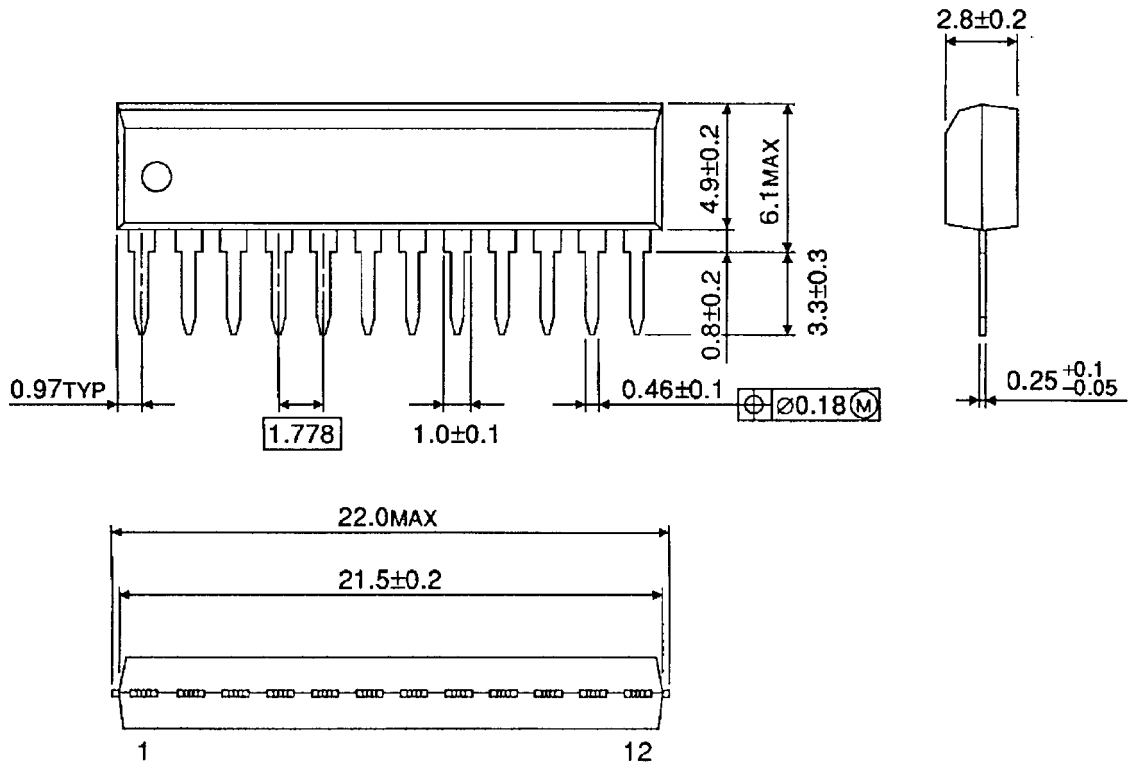

Weight: 0.71g (Typ.)

RESTRICTIONS ON PRODUCT USE

000707EAA_S

- TOSHIBA is continually working to improve the quality and reliability of its products. Nevertheless, semiconductor devices in general can malfunction or fail due to their inherent electrical sensitivity and vulnerability to physical stress. It is the responsibility of the buyer, when utilizing TOSHIBA products, to comply with the standards of safety in making a safe design for the entire system, and to avoid situations in which a malfunction or failure of such TOSHIBA products could cause loss of human life, bodily injury or damage to property.
In developing your designs, please ensure that TOSHIBA products are used within specified operating ranges as set forth in the most recent TOSHIBA products specifications. Also, please keep in mind the precautions and conditions set forth in the "Handling Guide for Semiconductor Devices," or "TOSHIBA Semiconductor Reliability Handbook" etc..
- The information contained herein is presented only as a guide for the applications of our products. No responsibility is assumed by TOSHIBA CORPORATION for any infringements of intellectual property or other rights of the third parties which may result from its use. No license is granted by implication or otherwise under any intellectual property or other rights of TOSHIBA CORPORATION or others.
- The information contained herein is subject to change without notice.