

# TA8100N/F

## 3V AM/FM IF IC WITH POWER AMPLIFIER

TA8100N/F is AM/FM IF IC with power amplifier and suitable for low voltage portable radio. This IC is able to drive LED for Turning Indication.

- . It can drive 4Ω load directly  
:  $P_o=220\text{mW}$  (Typ.), THD=10% (3V/4Ω)
- . Incorporates, AM RF Amp, AM Local Oscillator, AM Mixer, AM/FM IF Amp, AM/FM Detector, AM AGC Circuit and B Class-Audio Power Amplifier.
- . Low Overload Distortion at AM.
- . Wide Power Supply Voltage Range  
:  $V_{opr}=1.8\sim 5\text{V}$  ( $T_a=25^\circ\text{C}$ )

### MAXIMUM RATINGS ( $T_a=25^\circ\text{C}$ )

CHARACTERISTIC	SYMBOL	RATING	UNIT
Supply Voltage	VCC	6	V
Output Current (Peak)	$I_{O(\text{peak})}$	550	mA
LED Current	$I_{LED}$	15	mA
Power Dissipation (Note)	TA8100F	800	mW
	TA8100N	1200	
Operating Temperature	$T_{opr}$	-25~75	°C
Storage Temperature	$T_{stg}$	-55~150	°C

Note : Derated above  $T_a=25^\circ\text{C}$  in the proportion of 6.4mW/°C for TA8100F and of 9.6mW/°C for TA8100N.

Unit in mm

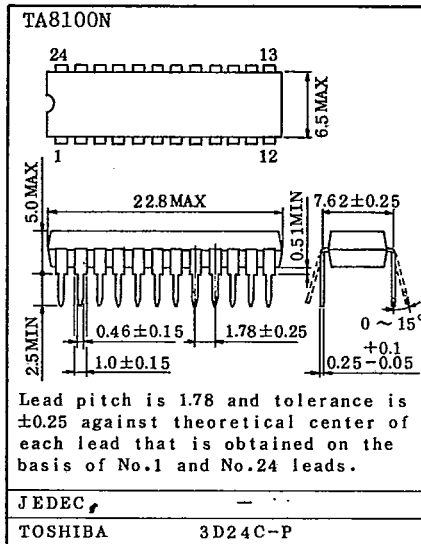

Weight : 1.2g

Unit in mm

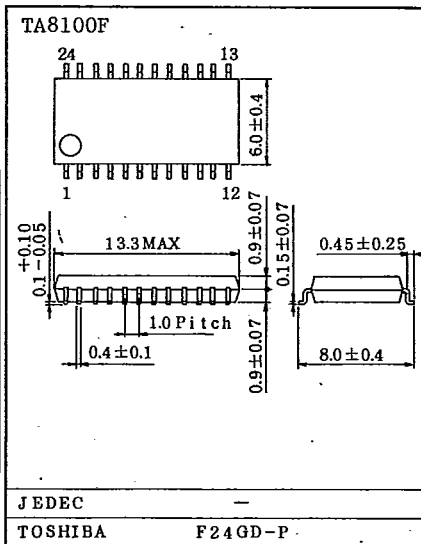

Weight : 0.31g

# TA8100N/F

T-77-05-07

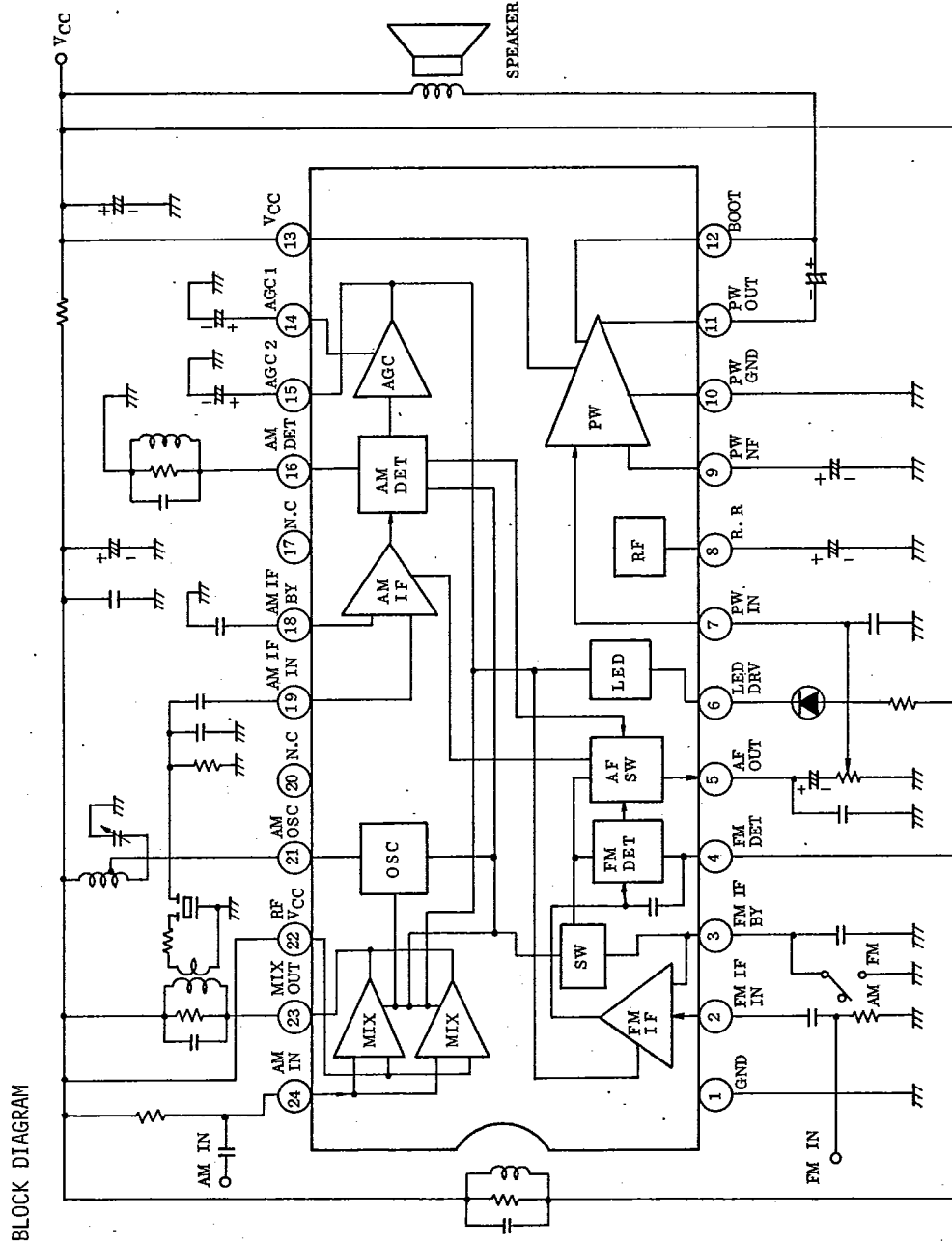

(Note) 17, 20 pin: Non Connection

**AUDIO LINEAR IC**

# TA8100N/F

T-77-05-07

## TERMINAL EXPLANATION

TERMINAL VOLTAGE: Typical Terminal Voltage at No Signal with Test Circuit  
(V<sub>CC</sub>=3.0V, T<sub>a</sub>=25°C)

No.	TERMINAL NAME	CONTENTS	EQUIVALENT CIRCUIT	VOLTAGE	
				AM(V)	FM(V)
1	GND	IF GND	-	0	0
2	FM IF IN	FM IF (10.7MHz) Input Terminal		2.4	2.0
3	FM IF BY	FM IF BYPASS		0	2.0
4	FM DET	FM Quad Rature Detection Circuit		3.0	3.0
5	AF OUT	Audio Signal Output Terminal	<p>( )..... ON at FM only</p>	0.3	0.8
6	LED DRIVER	LED Terminal		-	-

# TA8100N/F

T-77-05-07

## TERMINAL EXPLANATION

No.	TERMINAL NAME	CONTENTS	EQUIVALENT CIRCUIT	VOLTAGE	
				AM(V)	FM(V)
7	PW IN	Audio Signal Input Terminal		0.01	0.01
8	RIPPLE	Ripple Filter Terminal		1.4	1.4
9	PW NF	NF Terminal		0.6	0.6
10	PW GND	GND	-	0	0
11	PW OUT	Audio Signal Output Terminal		1.5	1.5
12	BOOT	Bootstrap		2.8	2.8
13	VCC	Power Supply	-	3.0	3.0
14	AGC 1	AM AGC 1		0.6	0
15	AGC 2	AM AGC 2		0.6	0
16	AM DET	AM Detector		0	0

**AUDIO LINEAR IC**

**TA8100N/F**

T-77-05-07

TERMINAL EXPLANATION

No.	TERMINAL NAME	CONTENTS	EQUIVALENT CIRCUIT	VOLTAGE	
				AM(V)	FM(V)
17	N.C	Non Connection	-	-	-
18	AM IF BY	AM IF Amplifier Bypass		1.3	0
19	AM IF IN	AM IF (455kHz) Input Terminal		1.3	0
20	N.C	Non Connection	-	-	-
21	AM OSC	AM Oscillation Terminal		3.0	3.0
22	VCC	Power Supply	-	3.0	3.0
23	AM MIX OUT	AM MIXER Output Terminal		3.0	3.0
24	AM IN	AM RF Signal Input Terminal		3.0	3.0

TA8100N/F

T-77-05-07

## ELECTRICAL CHARACTERISTICS

Unless otherwise specified,  $V_{CC}=3V$ ,  $T_a=25^{\circ}C$ FM :  $f=10.7MHz$ ,  $\Delta f=\pm 22.5kHz$  dev.,  $f_m=1kHz$ AM :  $f=1MHz$ , Mod=30%,  $f_m=1kHz$ PW :  $f=1kHz$ ,  $R_L=4\Omega$ ,  $R_g=600\Omega$ 

CHARACTERISTIC	SYMBOL	TEST CIRCUIT	TEST CONDITION	MIN.	TYP.	MAX.	UNIT	
Power Supply Current (Including PW Amplifier)	I <sub>CC</sub> (FM)	-	V <sub>IN</sub> =0	-	12	20	mA	
			V <sub>IN</sub> =0, V <sub>CC</sub> =4.5V	-	14	23		
	I <sub>CC</sub> (AM)	-	V <sub>IN</sub> =0	-	11	19		
			V <sub>IN</sub> =0, V <sub>CC</sub> =4.5V	-	13	22		
FM	Input Limiting Voltage	V <sub>IN</sub> (lim)	-3dB Limiting Point	-	36	42	dB $\mu$	
	Recovered Output Voltage	V <sub>OD</sub>	V <sub>IN</sub> =80dB $\mu$	22	31	44	mV <sub>rms</sub>	
	Signal to Noise Ratio	S/N	V <sub>IN</sub> =80dB $\mu$	-	70	-	dB	
	Total Harmonic Distortion	THD	V <sub>IN</sub> =80dB $\mu$	-	0.3	-	%	
	AM Rejection Ratio	AMR	V <sub>IN</sub> =80dB $\mu$ , Mod=30%	-	33	-	dB	
	LED Sensitivity	V <sub>L</sub>	I <sub>L</sub> =1mA	44	50	56	dB $\mu$	
AM	Gain	G <sub>v</sub>	V <sub>IN</sub> =30dB $\mu$	5	11	17	mV <sub>rms</sub>	
	Recovered Output Voltage	V <sub>OD</sub>	V <sub>IN</sub> =66dB $\mu$	22	31	44	mV <sub>rms</sub>	
	Signal to Noise Ratio	S/N	V <sub>IN</sub> =66dB $\mu$	-	46	-	dB	
	Total Harmonic Distortion	THD 1	-	V <sub>IN</sub> =66dB $\mu$	-	1.5	-	%
		THD 2	-	V <sub>IN</sub> =106dB $\mu$	-	4.0	-	
	Local OSC Stop Voltage	V <sub>stop</sub>	-	V <sub>OSC</sub> : -6dB down point	-	-	1.5	V
LED Sensitivity	V <sub>L</sub>	-	I <sub>L</sub> =1mA	24	30	36	dB $\mu$	
PW	Voltage Gain	G <sub>v</sub>	V <sub>IN</sub> =-40dBm (7.7mV)	37	40	43	dB	
	Output Power	P <sub>o1</sub>	THD=10%	180	220	-	mW	
		P <sub>o2</sub>	V <sub>CC</sub> =4.5V, THD=10%	-	500	-		
	Total Harmonic Distortion	THD	-	P <sub>O</sub> =50mW	-	0.5	2	%
Output Noise	V <sub>NO</sub>	-	R <sub>g</sub> =10k $\Omega$ BW=30Hz~20kHz	-	0.18	-	mV <sub>rms</sub>	

V<sub>IN</sub> : Open Measurement

AUDIO LINEAR IC

# TA8100N/F

T-77-05-07

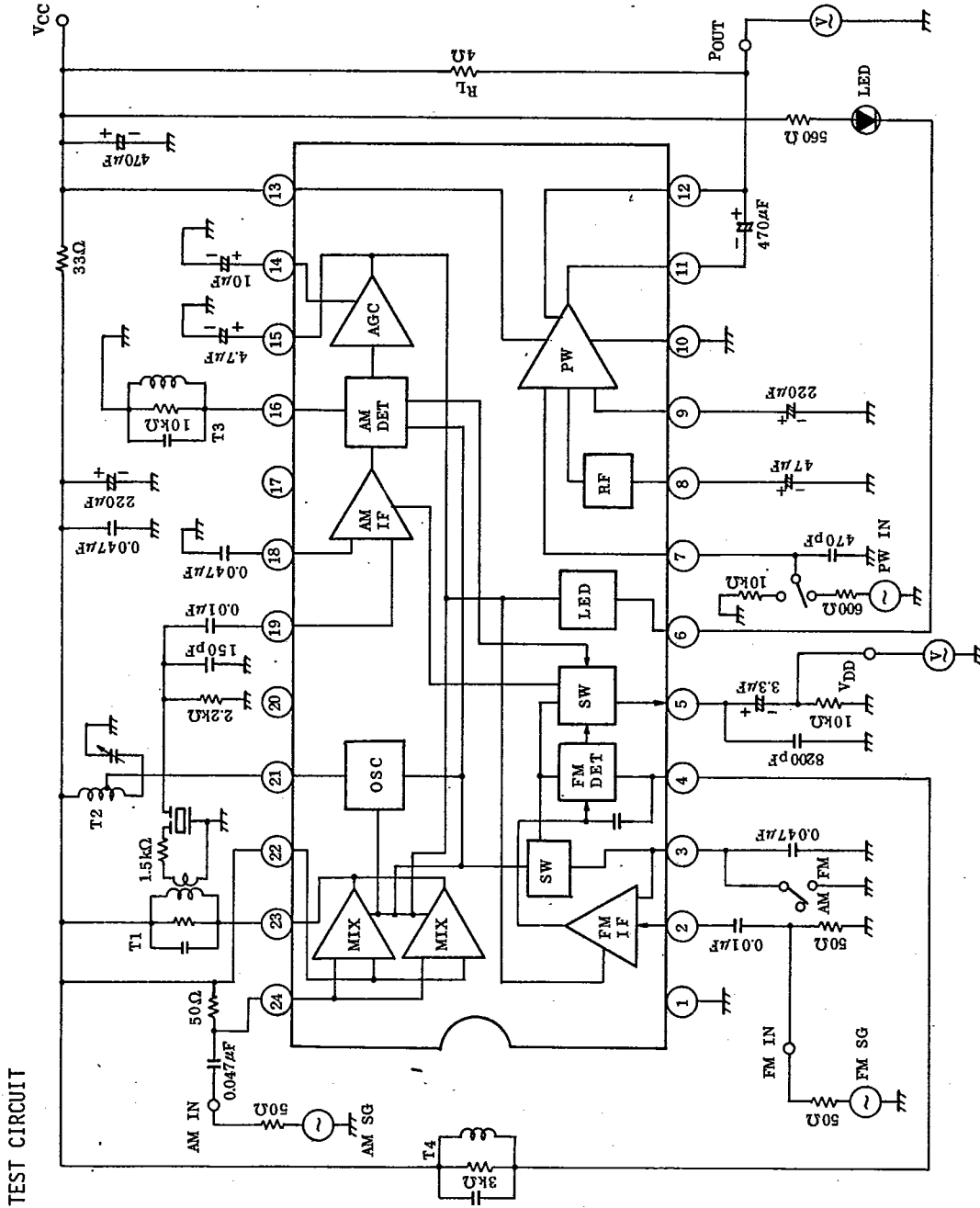

TEST CIRCUIT

**TOSHIBA**

9097247 TOSHIBA. ELECTRONIC

02E 17690 D

**TA8100N/F**

T-77-05-07

## COIL DATA

## T1 AM MIX

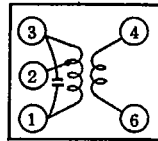

(BOTTOM VIEW)

Co (pF)	f (MHz)	Q <sub>o</sub>	TURNS		
			1-2	2-3	4-6
1-3	455	1-3	12	51	17
1500		60			

SUMIDA ELECTRIC Co.,Ltd

2150-2105-261

WIRE : 0.1mm $\phi$  UEW

## T2 AM OSC

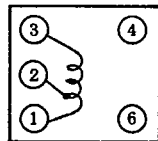

(BOTTOM VIEW)

f (kHz)	L ( $\mu$ H)	Q <sub>o</sub>	TURNS	
			1-2	2-3
796	268	125	15	89

SUMIDA ELECTRIC Co.,Ltd

2157-2239-213A

WIRE : 0.06mm $\phi$  UEW

## T3 AM DET

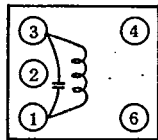

(BOTTOM VIEW)

Co (pF)	f (kHz)	Q <sub>o</sub>	TURNS
			1-3
1-3	455	105	127
330			

SUMIDA ELECTRIC Co.,Ltd

2150-2083-061

WIRE : 0.06mm $\phi$  UEW

## T4 FM DET

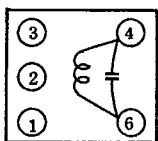

(BOTTOM VIEW)

Co (pF)	f (MHz)	Q <sub>o</sub>	TURNS
			4-6
4-6	10.7	95	10
150			

SUMIDA ELECTRIC Co.,Ltd

2153-4095-331

WIRE : 0.14mm $\phi$  UEW

AUDIO LINEAR IC



## TA8100N/F

T-77-05-07

## APPLICATION NOTE

## 1. AM IF INPUT

AM IF signal (455kHz) is fed to pin (19).  
To keep stability at weak signal,  
connect the external resistor and  
capacitor as shown in Fig.1.

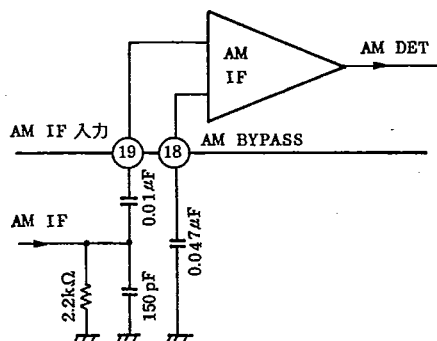

Fig.1 AM IF

## 2. BOOTSTRAP

When the load resistor,  $R_L$  is  $16\Omega$ ,  
oscillation may occur just before  
clipping of the output wave.  
(Except for  $R_L=8\Omega$ ,  $4\Omega$ ) So, connect  
the small resistor as shown in Fig.2.

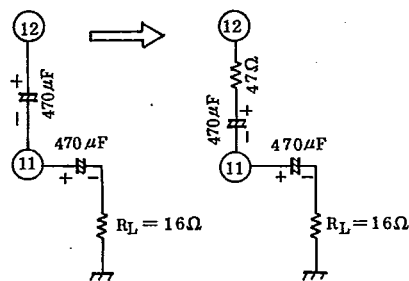

Fig.2 BOOTSTRAP

## 3. FM IF INPUT

It is not needed to use a transistor  
between F/E and AM/FM IF to get a high  
gain because this IC has a enough gain  
( $V_{IN(lim)}=36dB\mu$ ).

When the signal source impedance is high,  
be careful of the value of  $R_1$  and pattern  
layout to keep stability at weak signal  
(Fig.3).

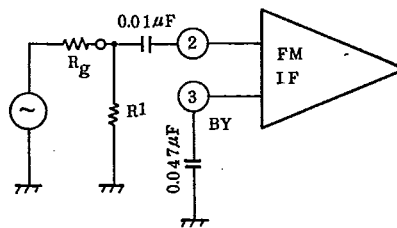
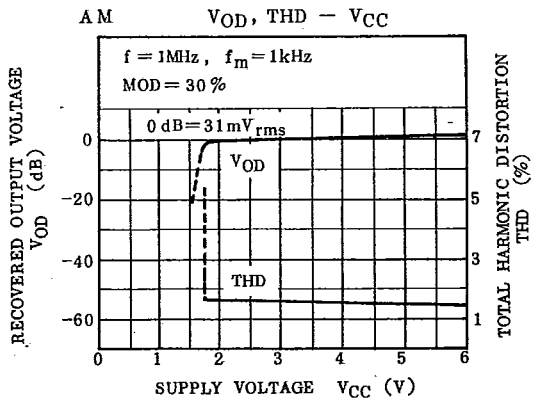
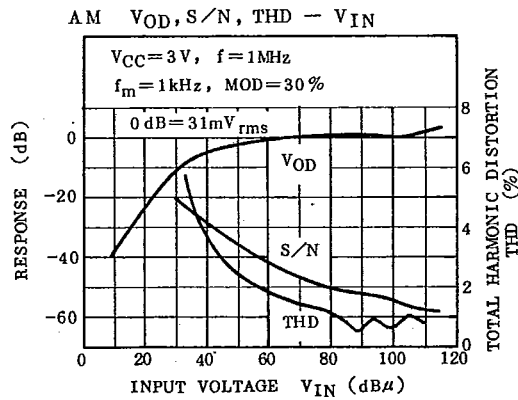
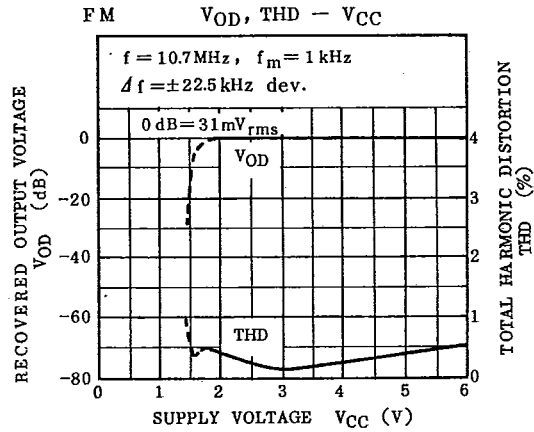
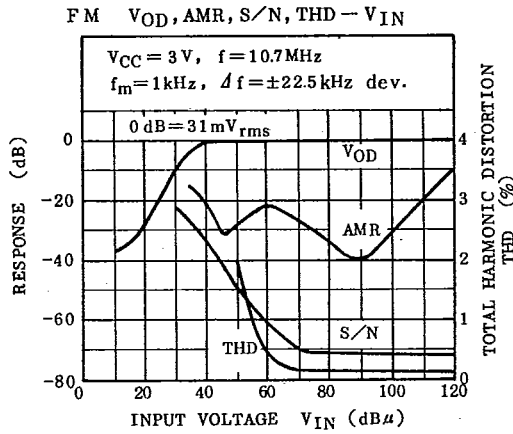
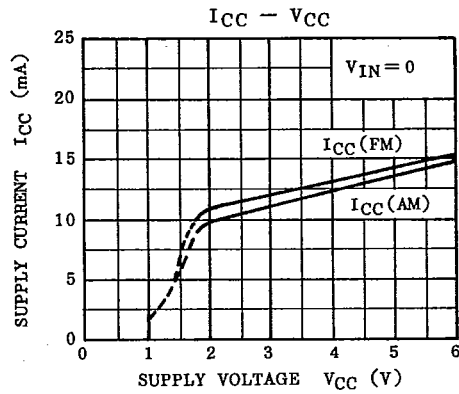

Fig.3 FM IF

# TA8100N/F

T-77-05-07



AUDIO LINEAR IC

**TA8100N/F**

T-77-05-07

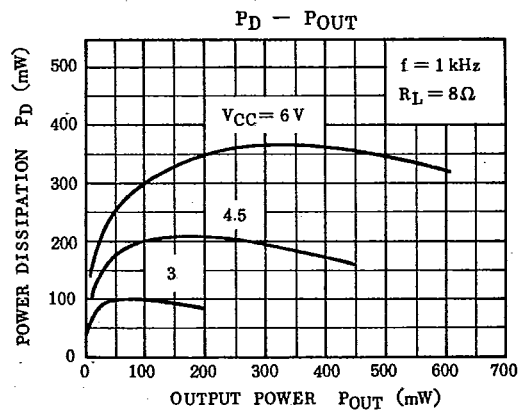
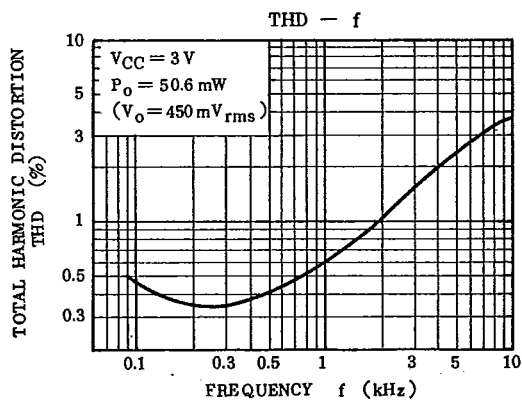
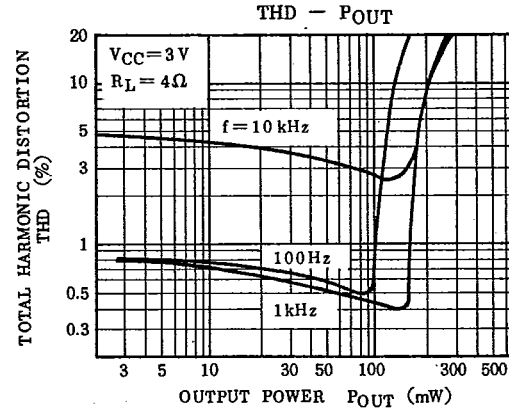
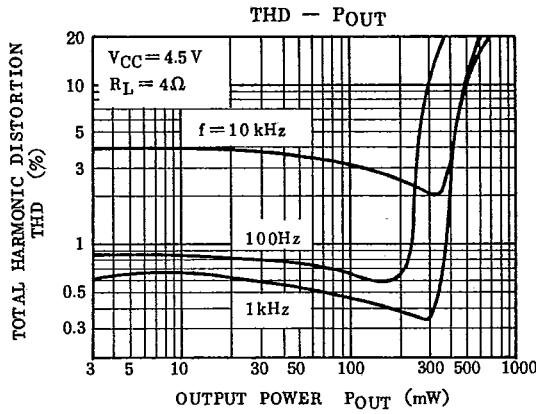
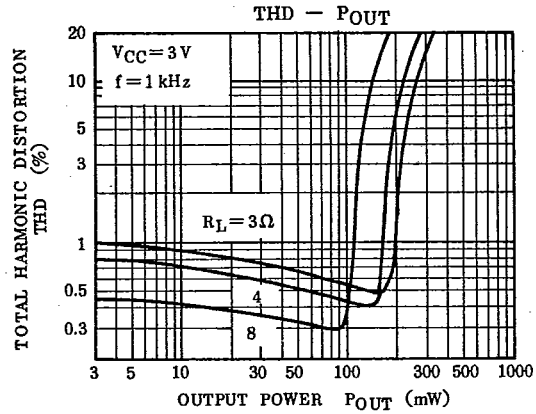
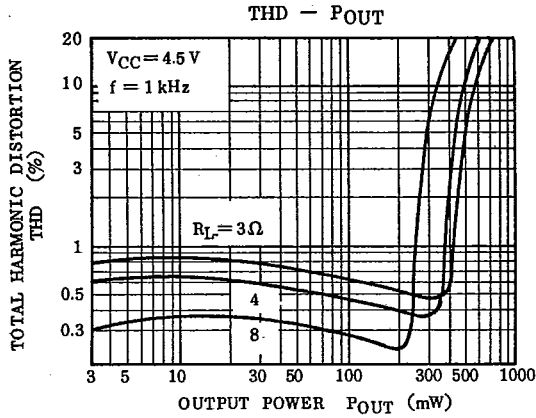

# TA8100N/F

T-77-05-07

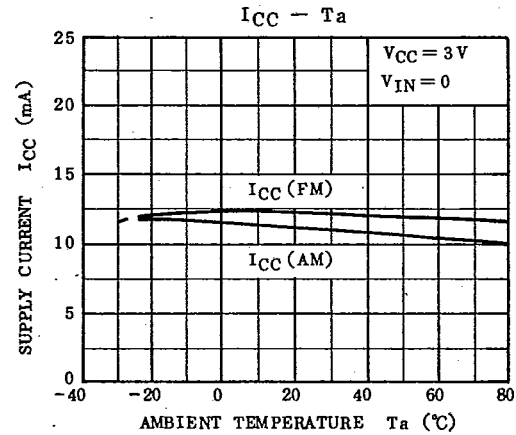
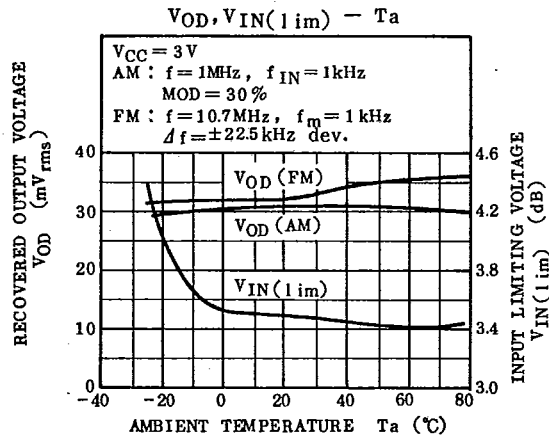
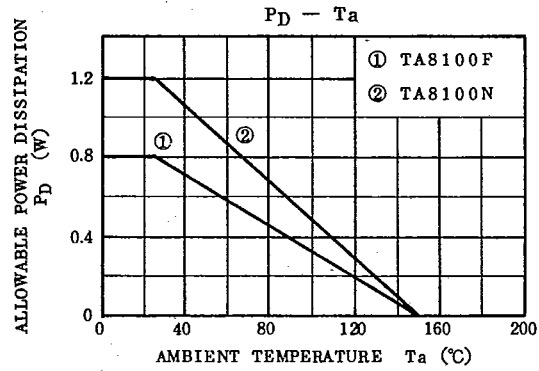
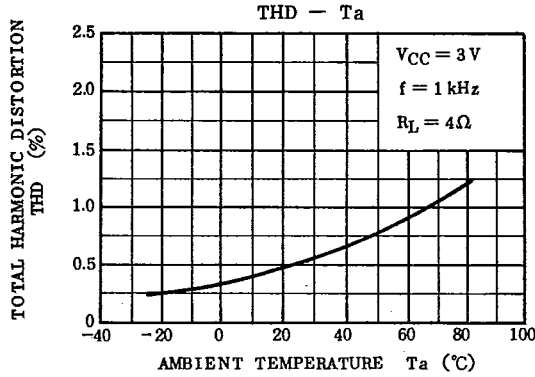
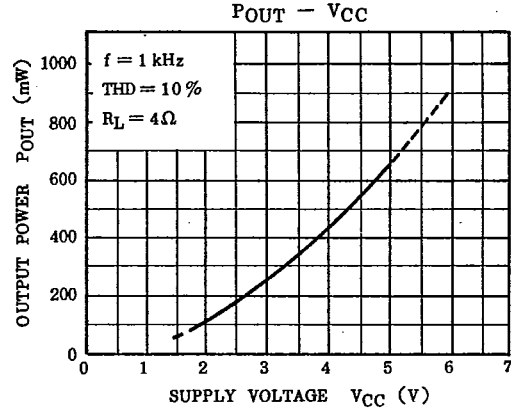
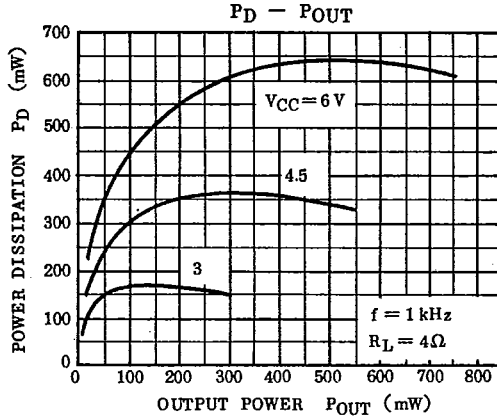

AUDIO LINEAR IC

# TA8100N/F

T-77-05-07

## APPLICATION CIRCUIT

3V AM/FM RADIO CIRCUIT (for example)

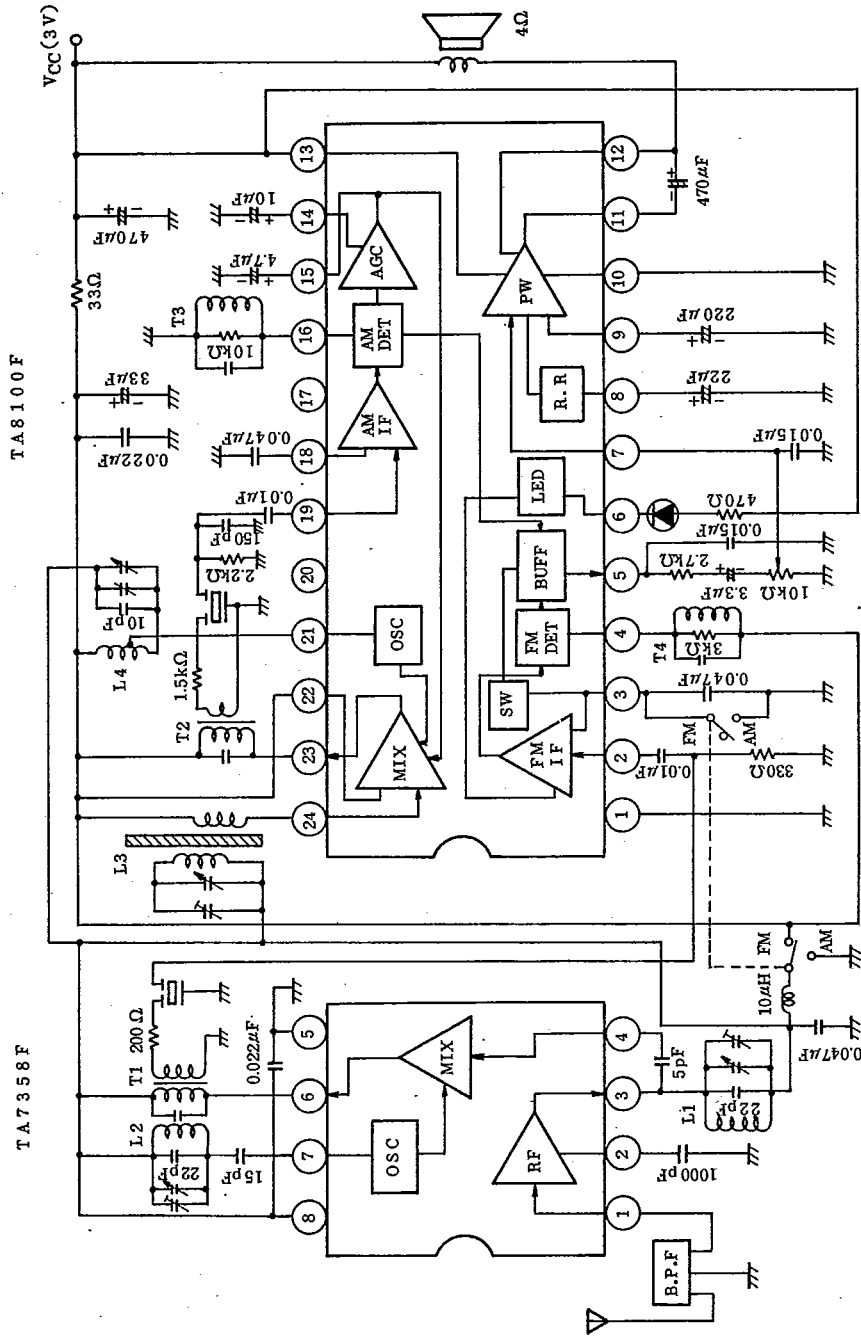

TA8100F

TA7358F

# TA8100N/F

T-77-05-07

## COIL DATA (APPLICATION CIRCUIT)

L1 : FM RF COIL

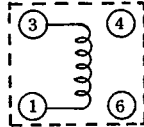

f (MHz)	L(μH)	Q <sub>o</sub>	TURNS	WIRE (mm)
100	0.06	100	1-3 1/4	0.5 UEW

L2 : FM OSC COIL

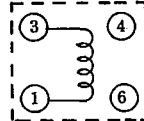

f (MHz)	L(μH)	Q <sub>o</sub>	TURNS	WIRE (mm)
100	0.045	100	3-1 3/4	0.5 UEW

L3 : AM ANT COIL

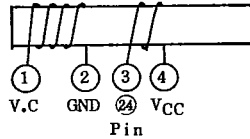

f (kHz)	L(μH)	Q <sub>o</sub>	TURNS	WIRE (mm)
796	600	200	1-2 95 3-4 17	7/0.07 USTC

CORE : 10mmφ × 80mm

L4 : AM OSC COIL

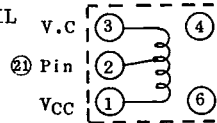

f (kHz)	L(μH)	Q <sub>o</sub>	TURNS	WIRE (mm)
796	268	90	1-2 13 2-3 75	0.08 UEW

MITSUMI YT20582, SUMIDA 2157-2239-213A

T1 : FM IFT

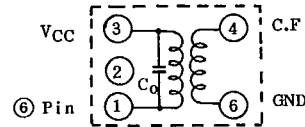

f (MHz)	C <sub>o</sub> (pF)	Q <sub>o</sub>	TURNS	WIRE (mm)
10.7	82	90	6-4 2 3-1 11	0.12 UEW

MITSUMI YT20580, SUMIDA 2153-414-041(5821)

T2 : AM IFT

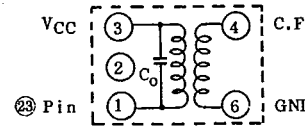

f (kHz)	C <sub>o</sub> (pF)	Q <sub>o</sub>	TURNS	WIRE (mm)
455	330	110	4-6 6 1-3 114	0.07 UEW

MITSUMI YT20583

T3 : AM DET

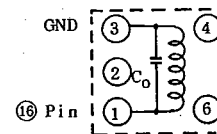

f (kHz)	C <sub>o</sub> (pF)	Q <sub>o</sub>	TURNS	WIRE (mm)
455	330	105	3-1 127	0.06 UEW

SUMIDA 2150-2083-061(4838)

T4 : FM DET

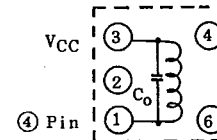

f (MHz)	C <sub>o</sub> (pF)	Q <sub>o</sub>	TURNS	WIRE (mm)
10.7	150	100	1-3 10	0.12 UEW

SUMIDA 2153-4095-331

AUDIO LINEAR IC