

# TA8119P

## Stereo Headphone Amplifier (3V USE)

The TA8119P is developed for play-back stereo headphone player (3V use), which is built-in preamplifiers, power amplifiers (for headphone) and DC volume controls.

### Features

- Built-in DC volume controls
- Coupling condenser-less for input of preamplifier
- The loop gain of power amplifier is 30dB (typ.), in case that DC volume is at maximum
- Available of external input signal from DC volume stage
- Low quiescent current ( $V_{CC} = 3V, T_a = 25^\circ C$ )  
 $ICCQ = 9mA$  (typ.)
- Operating supply voltage range ( $T_a = 25^\circ C$ )  
 $V_{CC} (opr) = 1.8\sim 6V$

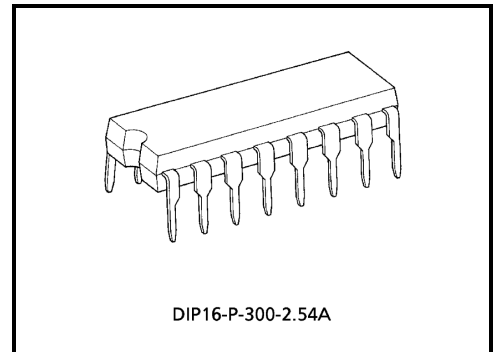

Weight: 1.00g (typ.)

### Block Diagram

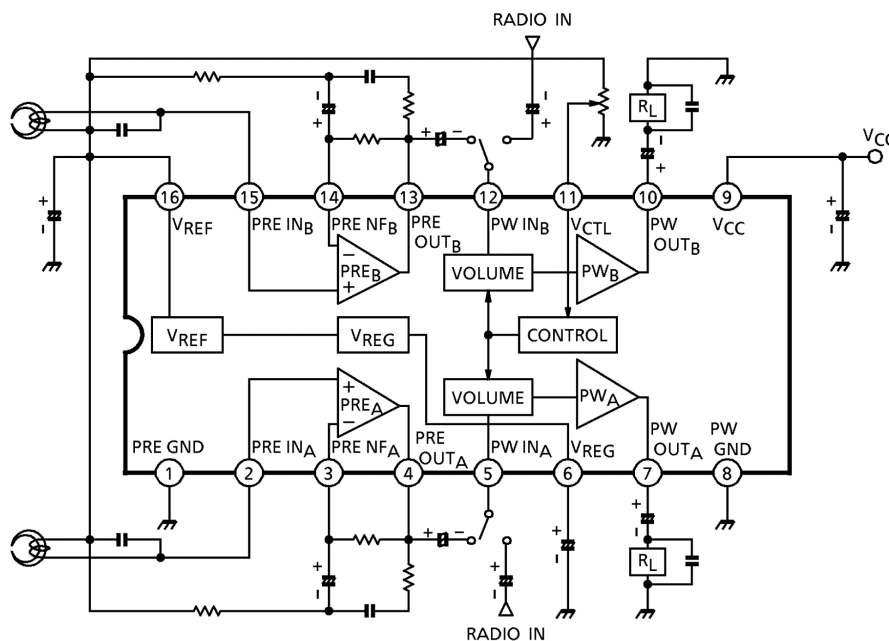

## Pin Function

Terminal Voltage: Typical Terminal Voltage at no Signal with Test Circuit  
 ( $V_{CC} = 3V$ ,  $T_a = 25^\circ C$ )

Pin No.	Pin Name	Contents	Equivalent	Terminal Voltage (V)
1	PRE GND	—	—	0
2	PRE IN <sub>A</sub>	Input of preamplifier		1.3
15	PRE IN <sub>B</sub>			1.3
3	PRE NF <sub>A</sub>	NF of preamplifier		1.3
14	PRE NF <sub>B</sub>			1.3
4	PRE OUT <sub>A</sub>	Output of preamplifier		1.3
13	PRE OUT <sub>B</sub>			1.3
5	PW IN <sub>A</sub>	Input of power amplifier for headphone (through DC volume stage)		1.3
12	PW IN <sub>B</sub>			1.3
6	V <sub>REG</sub>	Ripple filter of power supply		2.6
16	V <sub>REF</sub>	Reference voltage		1.3
7	PW OUT <sub>A</sub>	Output of power amplifier		1.3
10	PW OUT <sub>B</sub>			1.3
8	PW GND	—	—	0
9	V <sub>CC</sub>	—	—	3
11	V <sub>CTL</sub>	Input of control voltage for volume control		—

## Application Note

- (1) A volume which has the characteristic “curve A” is available for the DC volume control.
- (2) The capacitor C is used for absorbing volume sliding noise.
- (3) The DC volume control circuit is applicable to “function of mute”, connecting as Fig.1.  
In case of tuning mute-on, the load of “reference voltage circuit” is R, at maximum volume.
- (4) Small temperature coefficient and excellent frequency characteristic is needed by capacitors below.

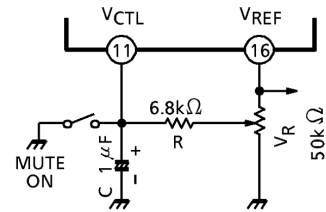

Fig.1 Function of mute

- Oscillation preventing capacitors for power amplifier output.
- Capacitor between VREF and GND.
- Capacitor between VCC and GND.
- Capacitor between VREG and GND.

## Maximum Ratings (Ta = 25°C)

Characteristic	Symbol	Rating	Unit
Supply voltage	V <sub>CC</sub>	7	V
Output current	I <sub>O</sub> (peak)	120	mA
Power dissipation	P <sub>D</sub> (Note)	750	mW
Operating temperature	T <sub>opr</sub>	-25~75	°C
Storage temperature	T <sub>stg</sub>	-55~150	°C

(Note) Derated above Ta = 25°C in the proportion of 6mW / °C.

## Electrical Characteristics

Unless Otherwise Specified,  $V_{CC} = 3V$ ,  $T_a = 25^\circ C$ ,  $f = 1kHz$

Preamplifier:  $R_L = 10k\Omega$ , Vol = Min

Power Amplifier:  $R_L = 32\Omega$ , Vol = Max

Characteristic		Symbol	Test Circuit	Test Condition	Min.	Typ.	Max.	Unit
Quiescent supply current		$I_{CCQ1}$	—	$V_{in} = 0$ , Vol = min	—	9.0	13.0	mA
		$I_{CCQ2}$	—	$V_{in} = 0$ , Vol = max	—	11.0	—	
Preamplifier section	Open loop voltage gain	$G_{VO}$	—	$V_o = -12dBV$	55	62	—	dB
	Closed loop voltage gain	$G_{VC}$	—	NAB = 1kHz, $V_o = -12dBV$	—	33	—	dB
	Maximum output voltage	$V_{om}$	—	THD = 1%	600	720	—	mV <sub>rms</sub>
	Total harmonic distortion	THD1	—	$V_o = -12dBV$	—	0.04	0.1	%
	Equivalent input noise voltage	$V_{ni}$	—	$R_g = 2.2k\Omega$ BPF = 30Hz~20kHz NAB ( $G_V = 33dB$ , $f = 1kHz$ )	—	1.2	2.0	$\mu V_{rms}$
	Ripple rejection ratio	RR1	—	$R_g = 2.2k\Omega$ $V_r = -22dBV$ , $f_r = 100Hz$	—	46	—	dB
Power amplifier section	Output power	(1)	$P_{o1}$	—	THD = 10%	20	27	mW
		(2)	$P_{o2}$	—	$R_L = 16\Omega$ , THD = 10%	—	39	
	Voltage gain (1)	$G_{V1}$	—	$V_o = -12dBV$	28	30	32	dB
	Channel balance	CB	—		—	0	1.5	dB
	Voltage gain (2)	$G_{V2}$	—	$V_o = -12dBV$ , Vol = mid	—	15	—	dB
	Total harmonic distortion	THD2	—	$P_o = 10mW$	—	0.5	1.2	%
		THD3	—	$P_o = 10mW$ , Vol = mid	—	0.3	—	
	Output noise voltage	$V_{no}$	—	$R_g = 600\Omega$ BPF = 30Hz~20kHz	—	250	320	$\mu V_{rms}$
	Maximum attenuation	ATT	—	$V_o = -12dBV$ Vol = max→min	66	72	—	dB
Ripple rejection ratio	RR2	—	$R_g = 600\Omega$ $V_r = -22dBV$ , $f_r = 100Hz$	—	46	—	dB	
Total	Cross talk (ch-A / ch-B)	CT	—	$R_g = 2.2k\Omega$ $V_o = -12dBV$ , Vol = max	34	40	—	dB

## Test Circuit

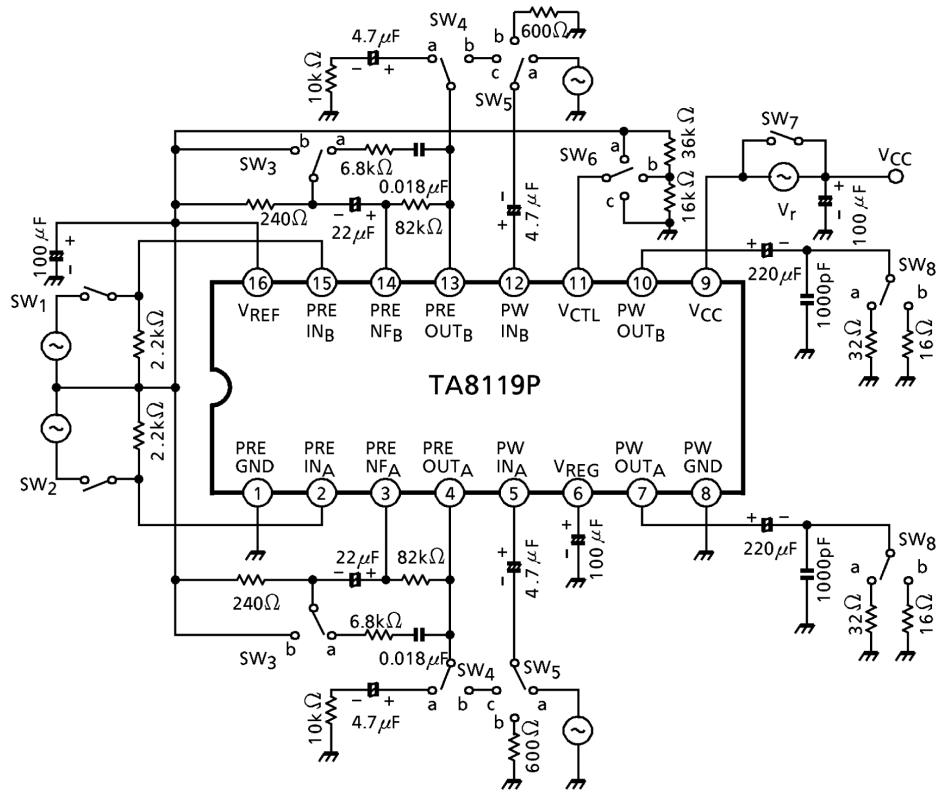

## Switch State For Electrical Characteristics

Characteristic	SW <sub>1</sub>	SW <sub>2</sub>	SW <sub>3</sub>	SW <sub>4</sub>	SW <sub>5</sub>	SW <sub>6</sub>	SW <sub>7</sub>	SW <sub>8</sub>
I <sub>CCQ1</sub>	×	×	a	a	b	c	○	a
I <sub>CCQ2</sub>	×	×	a	a	b	a	○	a
G <sub>VO</sub>	○	○	b	a	b	c	○	a
G <sub>VC</sub>	○	○	a	a	b	c	○	a
V <sub>om</sub>	○	○	a	a	b	c	○	a
THD1	○	○	a	a	b	c	○	a
V <sub>ni</sub>	×	×	a	a	b	c	○	a
RR1	×	×	a	a	b	c	×	a
P <sub>o1</sub>	×	×	a	a	a	a	○	a
P <sub>o2</sub>	×	×	a	a	a	a	○	b
G <sub>V1</sub>	×	×	a	a	a	a	○	a
CB	×	×	a	a	a	a	○	a
G <sub>V2</sub>	×	×	a	a	a	b	○	a
THD2	×	×	a	a	a	a	○	a
THD3	×	×	a	a	a	b	○	a
V <sub>no</sub>	×	×	a	a	b	a	○	a
ATT	×	×	a	a	a	a→c	○	a
RR2	×	×	a	a	b	c	×	a
CT	○ / ×	× / ○	a	b	c	a	○	a

○: Short    ×: Open

## Characteristic Curves

Unless Otherwise Specified:  $V_{CC} = 3V$ ,  $f = 1kHz$ ,  $T_a = 25^\circ C$

Preamplifier:  $R_L = 10k\Omega$ ,  $Vol = Min$

Power Amplifier:  $R_L = 32\Omega$ ,  $Vol = Max$

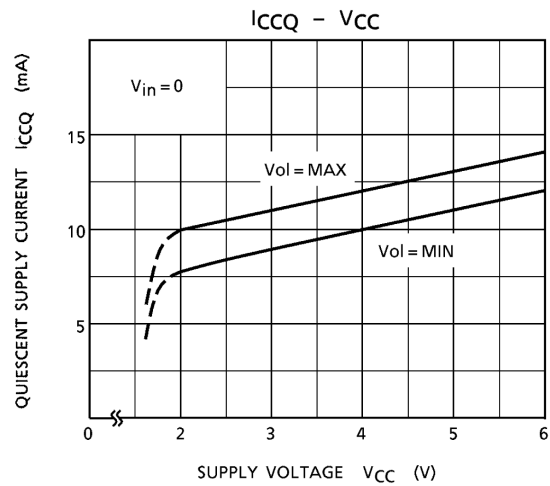
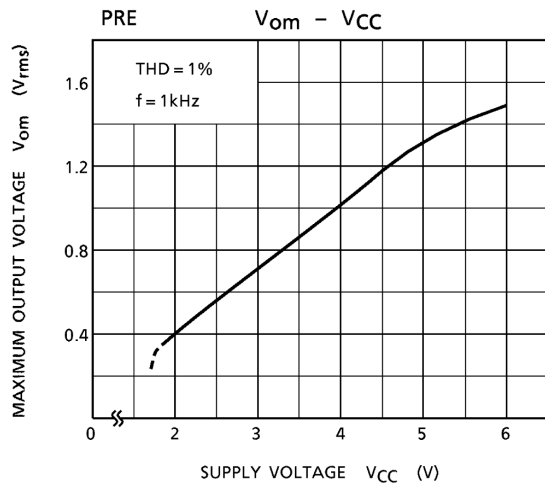
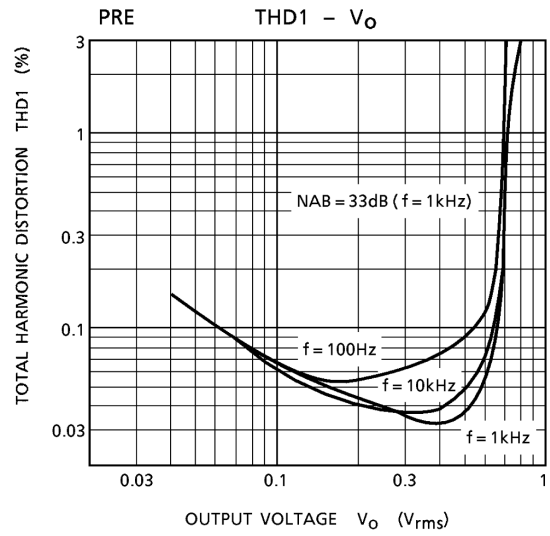
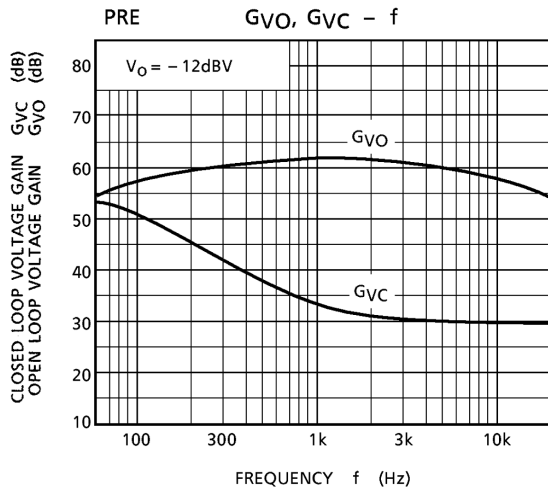

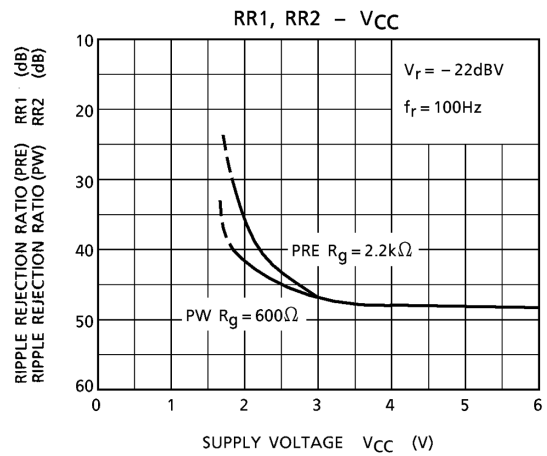
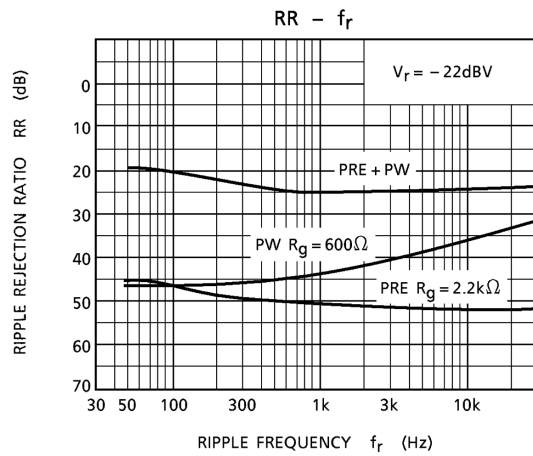
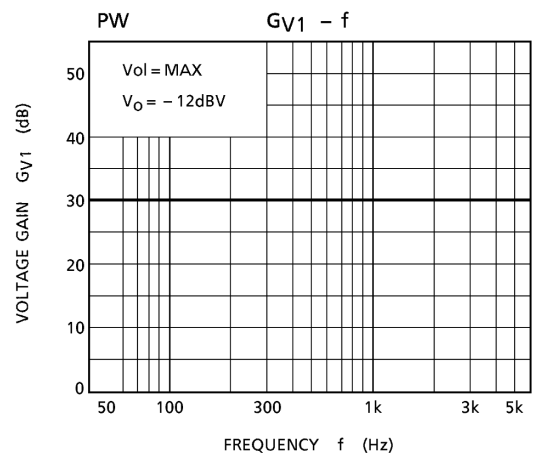
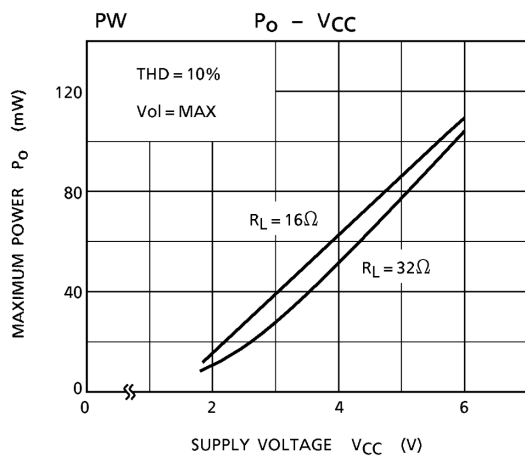
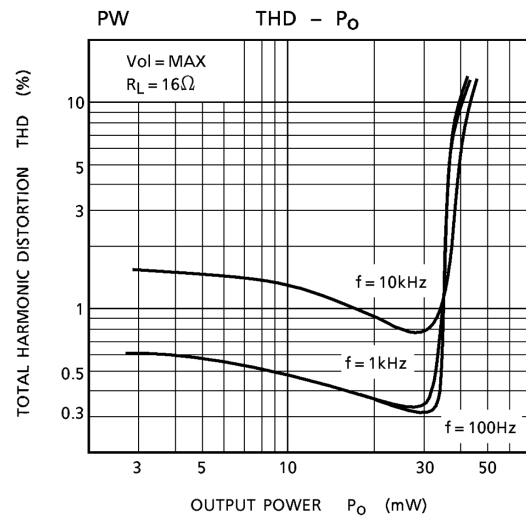
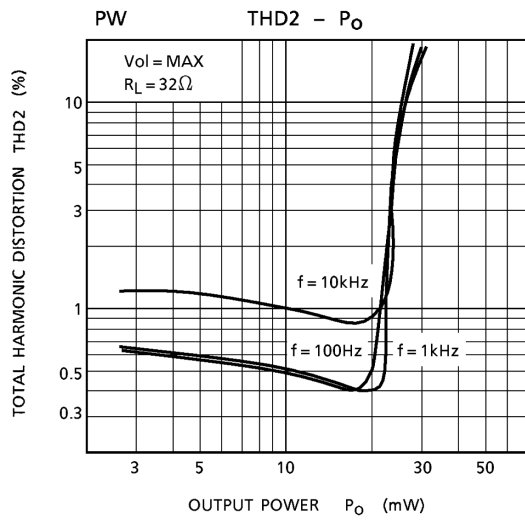



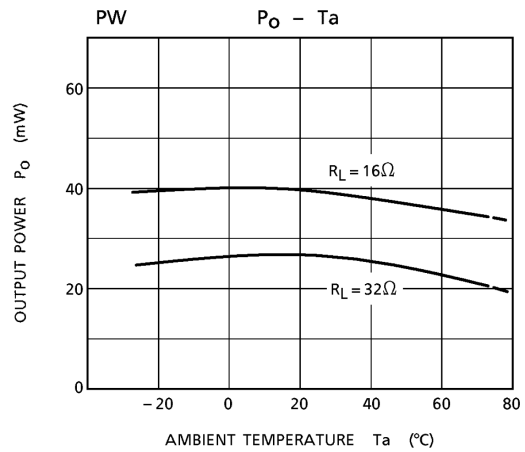
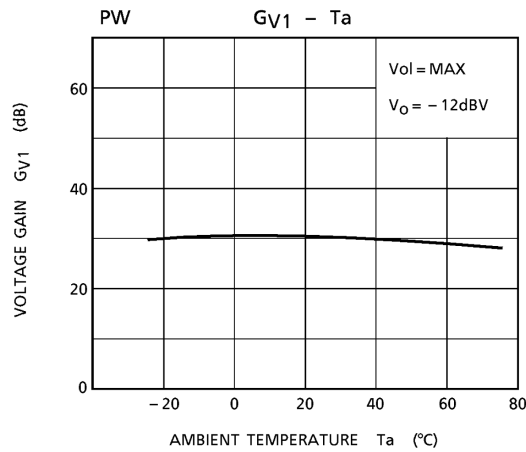
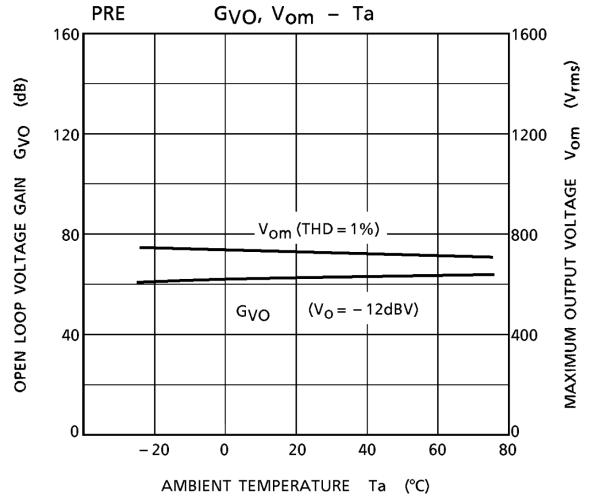
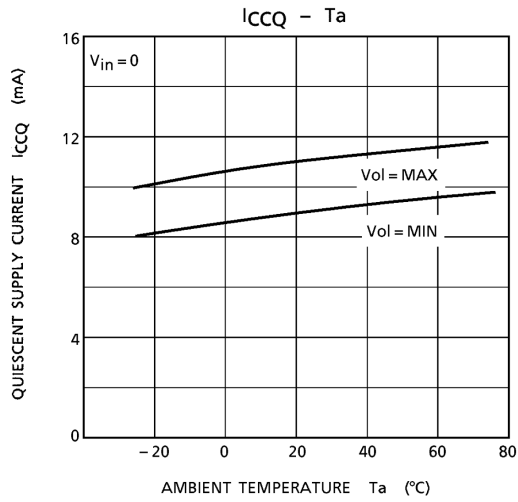
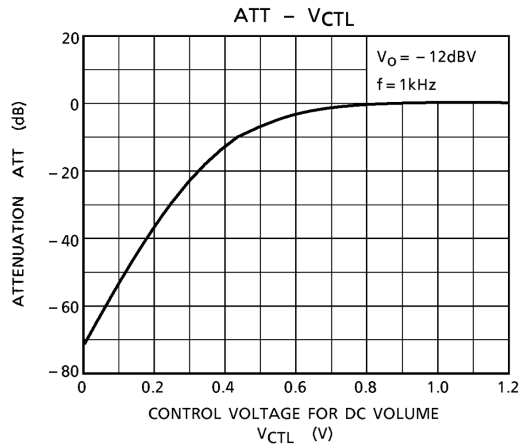
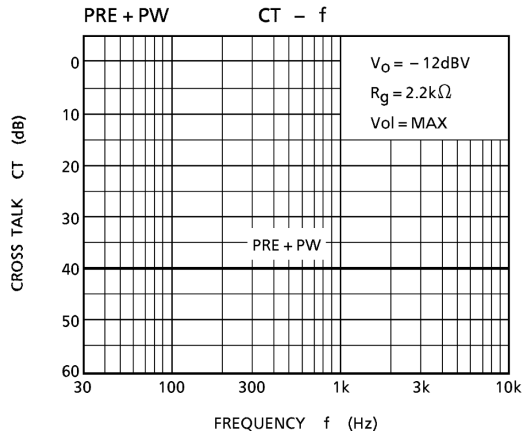

## Package Dimensions

DIP16-P-300-2.54A

Unit : mm

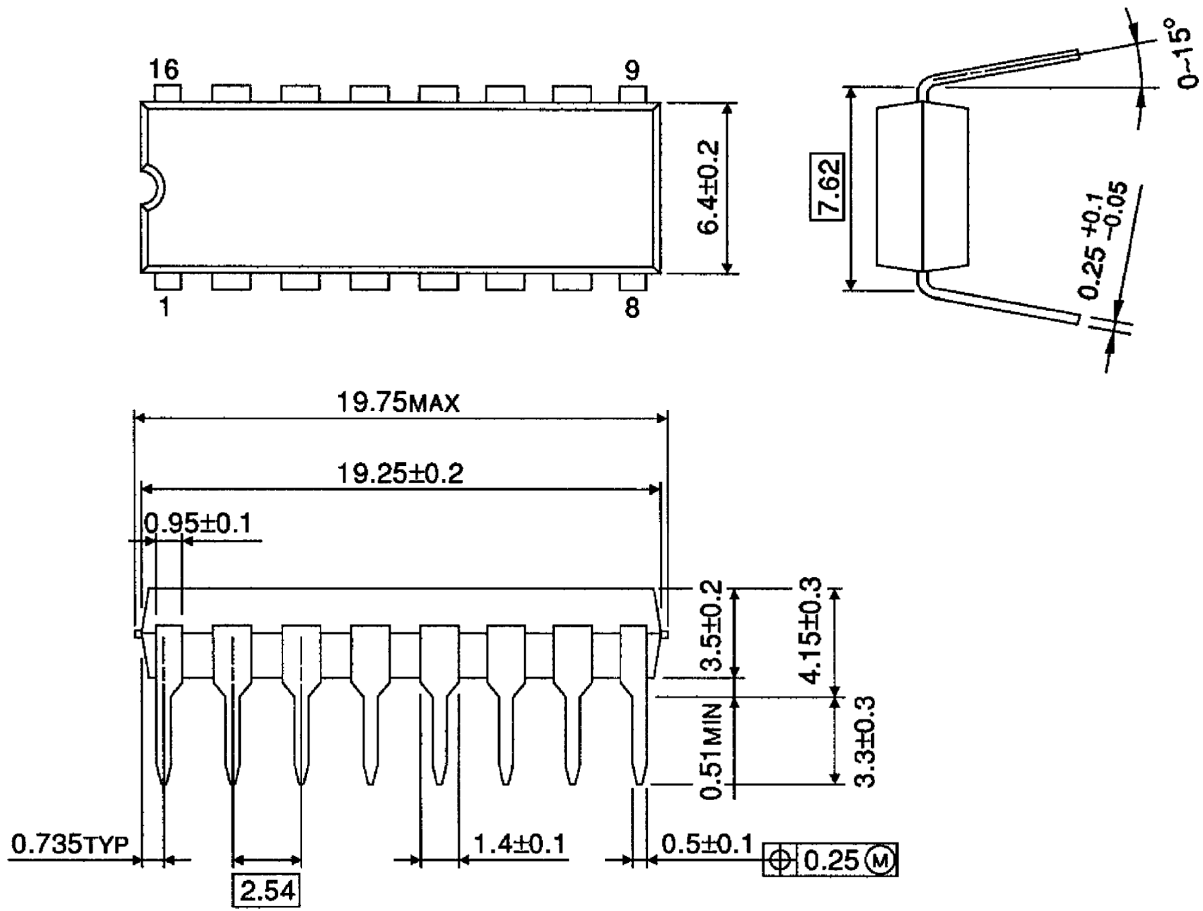

Weight: 1.00g (typ.)

**RESTRICTIONS ON PRODUCT USE**

000707EBA

- TOSHIBA is continually working to improve the quality and reliability of its products. Nevertheless, semiconductor devices in general can malfunction or fail due to their inherent electrical sensitivity and vulnerability to physical stress. It is the responsibility of the buyer, when utilizing TOSHIBA products, to comply with the standards of safety in making a safe design for the entire system, and to avoid situations in which a malfunction or failure of such TOSHIBA products could cause loss of human life, bodily injury or damage to property.  
In developing your designs, please ensure that TOSHIBA products are used within specified operating ranges as set forth in the most recent TOSHIBA products specifications. Also, please keep in mind the precautions and conditions set forth in the "Handling Guide for Semiconductor Devices," or "TOSHIBA Semiconductor Reliability Handbook" etc..
- The TOSHIBA products listed in this document are intended for usage in general electronics applications (computer, personal equipment, office equipment, measuring equipment, industrial robotics, domestic appliances, etc.). These TOSHIBA products are neither intended nor warranted for usage in equipment that requires extraordinarily high quality and/or reliability or a malfunction or failure of which may cause loss of human life or bodily injury ("Unintended Usage"). Unintended Usage include atomic energy control instruments, airplane or spaceship instruments, transportation instruments, traffic signal instruments, combustion control instruments, medical instruments, all types of safety devices, etc.. Unintended Usage of TOSHIBA products listed in this document shall be made at the customer's own risk.
- The products described in this document are subject to the foreign exchange and foreign trade laws.
- The information contained herein is presented only as a guide for the applications of our products. No responsibility is assumed by TOSHIBA CORPORATION for any infringements of intellectual property or other rights of the third parties which may result from its use. No license is granted by implication or otherwise under any intellectual property or other rights of TOSHIBA CORPORATION or others.
- The information contained herein is subject to change without notice.