

FOUR-CHANNEL AUTOMOTIVE DIGITAL AMPLIFIERS

Check for Samples: [TAS5414A](#), [TAS5424A](#)

FEATURES

- TAS5414A – Single-Ended Input
- TAS5424A – Differential Input
- Four-Channel Digital Power Amplifier
- Four Analog Inputs, Four BTL Power Outputs
- Typical Output Power per Channel at 10% THD+N
 - 28 W/Ch Into 4 Ω at 14.4 Vdc
 - 45 W/Ch Into 2 Ω at 14.4 Vdc
 - 58 W/Ch Into 4 Ω at 21 Vdc
 - 116 W/Ch Into 2 Ω at 21 Vdc PBTL
- Channels Can Be Paralleled (PBTL) for 1- Ω Applications
- THD+N < 0.02%, 1 kHz, 1 W Into 4 Ω
- Patented Pop- and Click-Reduction Technology
 - Soft Muting With Gain Ramp Control
 - Common-Mode Ramping
- Patented AM Interference Avoidance
- Patented Cycle-by-Cycle Current Limit
- 75-dB PSRR
- Four-Address I²C Serial Interface for Device Configuration and Control
- Channel Gains: 12-dB, 20-dB, 26-dB, 32-dB
- Load Diagnostic Functions:
 - Output Open and Shorted Load
 - Output-to-Power and -to-Ground Shorts
 - Patented Tweeter Detection
- Protection and Monitoring Functions:
 - Short-Circuit Protection
 - Load-Dump Protection to 50 V
 - Fortuitous Open Ground and Power Tolerant
 - Patented Output DC Level Detection While Music Playing
 - Overtemperature Protection
 - Over- and Undervoltage Conditions
 - Clip Detection
- 36-Pin PSOP3 (DKD) Power SOP Package With

Heat Slug Up for the TAS5414A

- 44-Pin PSOP3 (DKD) Power SOP Package With Heat Slug Up for the TAS5424A
- 64-Pin QFP (PHD) Power Package With Heat Slug Up for TAS5414A
- Designed for Automotive EMC Requirements
- Qualified According to AEC-Q100
- ISO9000:2002 TS16949 Certified
- –40°C to 105°C Ambient Temperature Range

APPLICATIONS

- High-Power OEM/Retail Head Units and Amplifier Modules Where Feature Densities and System Configurations Require Reduction in Heat From the Audio Power Amplifier

DESCRIPTION

The TAS5414A and TAS5424A are four-channel digital audio amplifiers designed for use in automotive head units and external amplifier modules. The TAS5414A and TAS5424A provide four channels at 23 W continuously into 4 Ω at less than 1% THD+N from a 14.4-V supply. Each channel can also deliver 38 W into 2 Ω at 1% THD+N. The TAS5414A uses single-ended analog inputs, while the TAS5424A employs differential inputs for increased immunity to common-mode system noise. The digital PWM topology of the TAS5414A and TAS5424A provides dramatic improvements in efficiency over traditional linear amplifier solutions. This reduces the power dissipated by the amplifier by a factor of ten under typical music playback conditions. The TAS5414A and TAS5424A incorporate all the functionality needed to perform in the demanding OEM applications area. They have built-in load diagnostic functions for detecting and diagnosing misconnected outputs to help to reduce test time during the manufacturing process.



Please be aware that an important notice concerning availability, standard warranty, and use in critical applications of Texas Instruments semiconductor products and disclaimers thereto appears at the end of this data sheet.

TAS5414A, TAS5424A

SLOS535C –MAY 2009–REVISED APRIL 2011

www.ti.com



These devices have limited built-in ESD protection. The leads should be shorted together or the device placed in conductive foam during storage or handling to prevent electrostatic damage to the MOS gates.

TAS5414A FUNCTIONAL BLOCK DIAGRAM

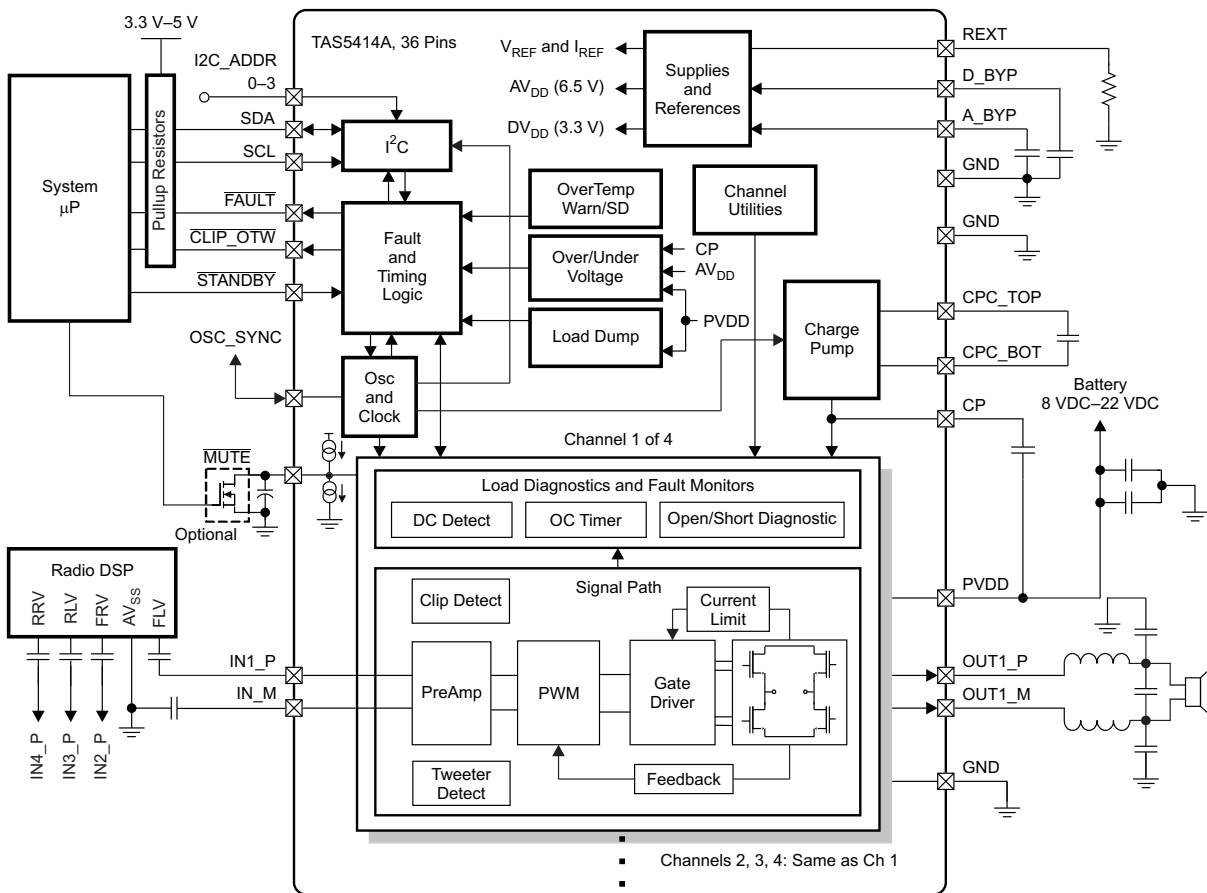

B0198-03

TAS5424A FUNCTIONAL BLOCK DIAGRAM

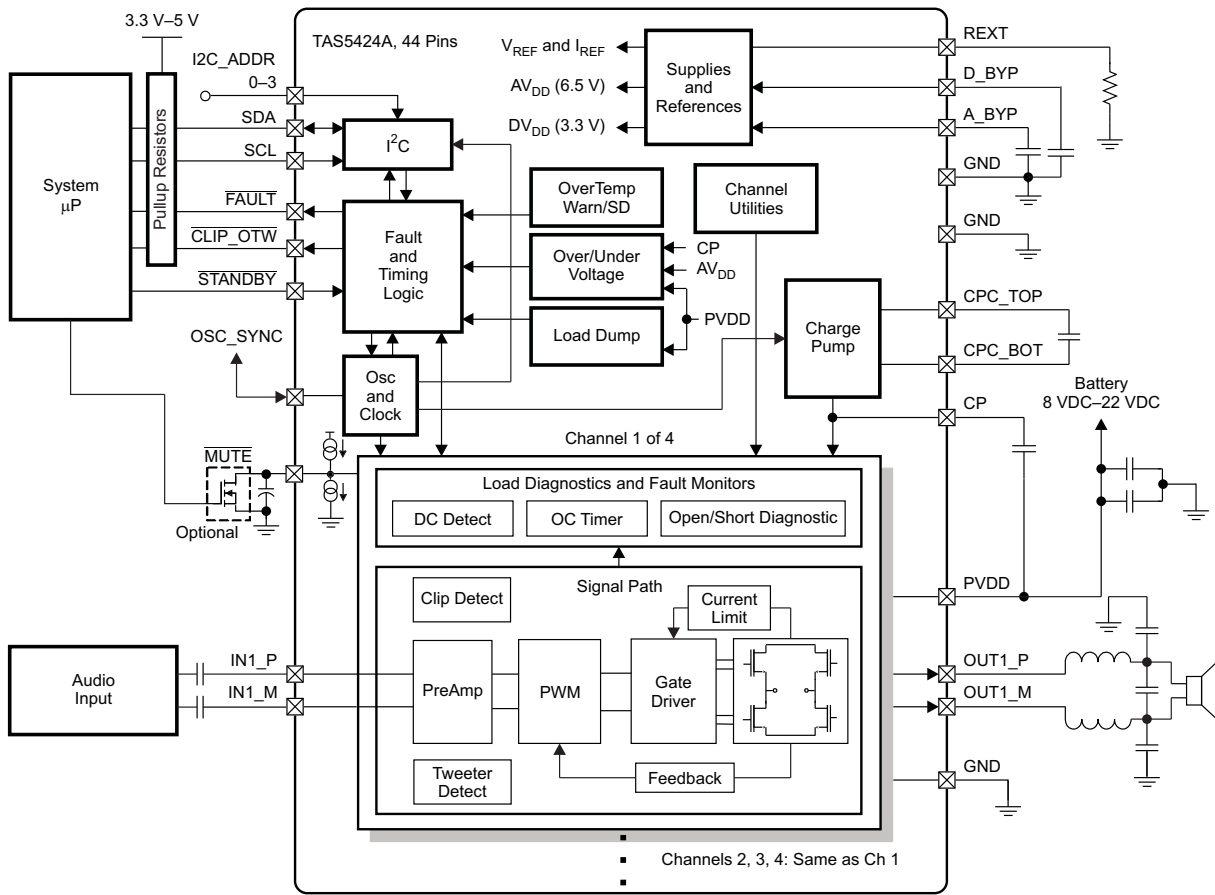

B0198-04

TAS5414A, TAS5424A

SLOS535C –MAY 2009–REVISED APRIL 2011

www.ti.com

PIN ASSIGNMENTS AND FUNCTIONS

The pin assignments for the TAS5414A and TAS5424A are shown as follows.

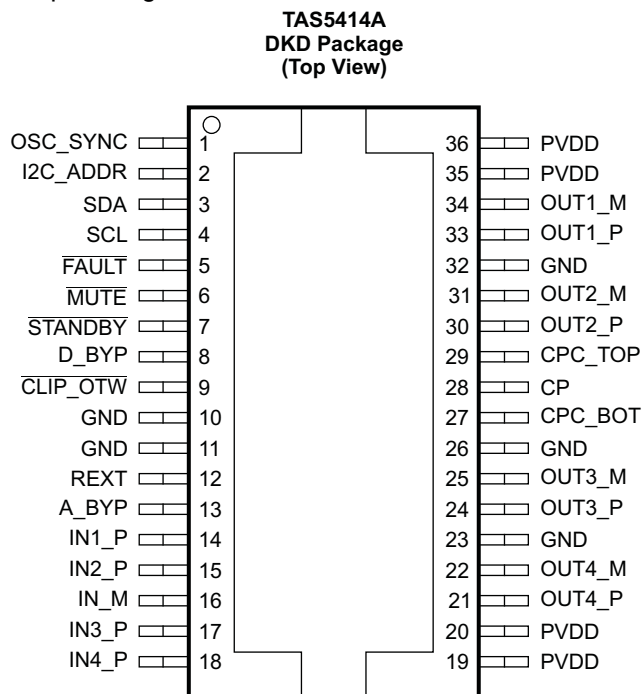

P0018-04

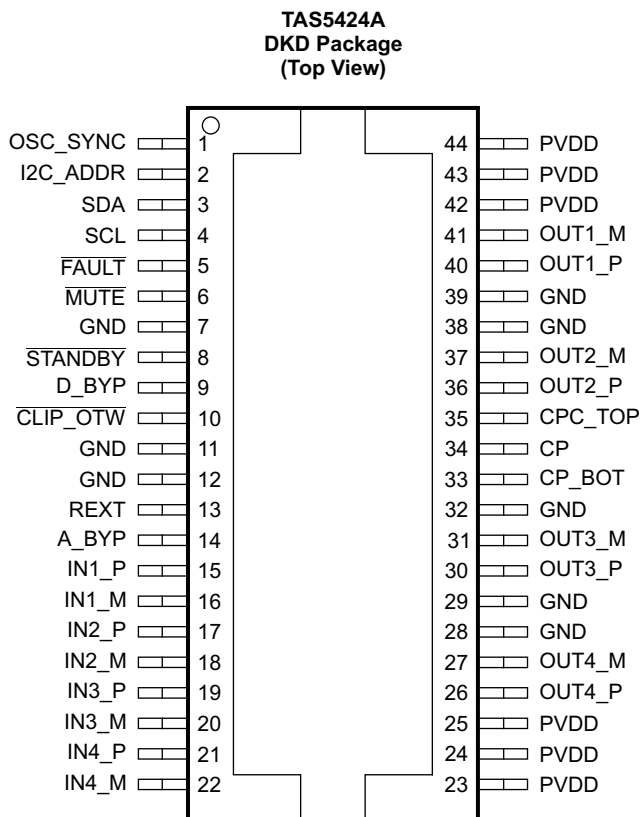

P0055-02

TAS5414A
PHD Package
(Top View)

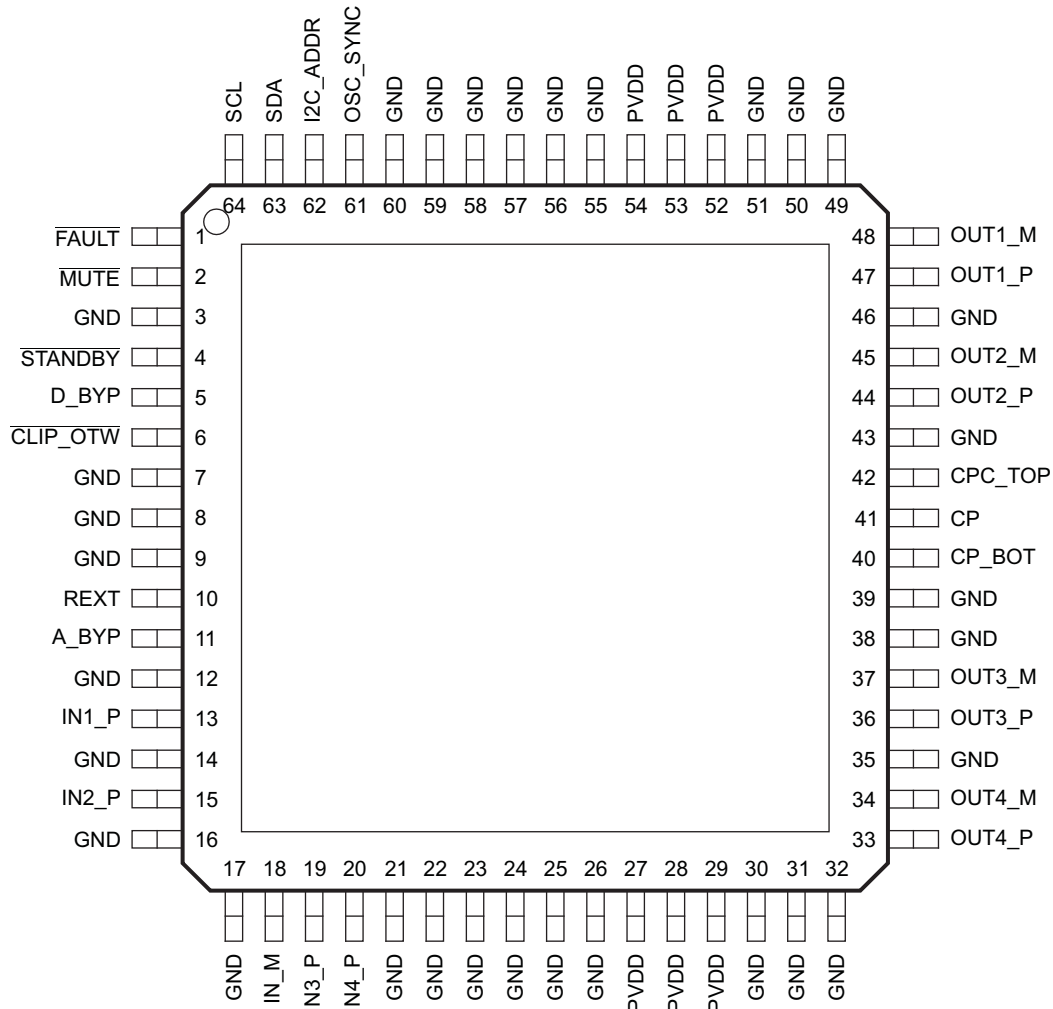

P0070-01

Table 1. TERMINAL FUNCTIONS

NAME	TERMINAL			TYPE ⁽¹⁾	DESCRIPTION
	DKD Package		PHD Package		
	TAS5414A NO.	TAS5424A NO.	TAS5414A NO.		
A_BYP	13	14	11	PBY	Bypass pin for the AVDD analog regulator
CLIP_OTW	9	10	6	DO	Open-drain CLIP, OTW, or logical OR of the CLIP and OTW outputs. It also reports tweeter detection during tweeter mode.
CP	28	34	41	CP	Top of main storage capacitor for charge pump (bottom goes to PVDD)
CPC_BOT	27	33	40	CP	Bottom of flying capacitor for charge pump
CPC_TOP	29	35	42	CP	Top of flying capacitor for charge pump
D_BYP	8	9	5	PBY	Bypass pin for DVDD regulator output
FAULT	5	5	1	DO	Global fault output (open drain): UV, OV, OTSD, OCSD, DC
GND	10, 11, 23, 26, 32	7, 11, 12, 28, 29, 32, 38, 39	3, 7, 8, 9, 12, 14, 16, 17, 21, 22, 23, 24, 25, 26, 30, 31, 32, 35, 38, 39, 43, 46, 49, 50, 51, 55, 56, 57, 58, 59, 60	AG / DG / PGND	Ground
I2C_ADDR	2	2	62	AI	I ² C address bit
IN1_M	N/A	16	N/A	AI	Inverting analog input for channel 1 (TAS5424A only)
IN1_P	14	15	13	AI	Non-inverting analog input for channel 1
IN2_M	N/A	18	N/A	AI	Inverting analog input for channel 2 (TAS5424A only)
IN2_P	15	17	15	AI	Non-inverting analog input for channel 2
IN3_M	N/A	20	N/A	AI	Inverting analog input for channel 3 (TAS5424A only)
IN3_P	17	19	19	AI	Non-inverting analog input for channel 3
IN4_M	N/A	22	N/A	AI	Inverting analog input for channel 4 (TAS5424A only)
IN4_P	18	21	20	AI	Non-inverting analog input for channel 4
IN_M	16	N/A	18	ARTN	Signal return for the 4 analog channel inputs (TAS5414A only)
MUTE	6	6	2	AI	Gain ramp control: mute (low), play (high)
OSC_SYNC	1	1	61	DI/DO	Oscillator sync input from master or output to slave amplifiers (20 MHz divided by 5, 6, or 7)
OUT1_M	34	41	48	PO	– polarity output for bridge 1
OUT1_P	33	40	47	PO	+ polarity output for bridge 1
OUT2_M	31	37	45	PO	– polarity output for bridge 2
OUT2_P	30	36	44	PO	+ polarity output for bridge 2
OUT3_M	25	31	37	PO	– polarity output for bridge 3
OUT3_P	24	30	36	PO	+ polarity output for bridge 3
OUT4_M	22	27	34	PO	– polarity output for bridge 4
OUT4_P	21	26	33	PO	+ polarity output for bridge 4
PVDD	19, 20, 35, 36	23, 24, 25, 42, 43, 44	27, 28, 29, 52, 53, 54	PWR	PVDD supply
REXT	12	13	10	AI	Precision resistor pin to set analog reference
SCL	4	4	64	DI	I ² C clock input from system I ² C master
SDA	3	3	63	DI/DO	I ² C data I/O for communication with system I ² C master
STANDBY	7	8	4	DI	Active-low STANDBY pin. Standby (low), power up (high)

(1) DI = digital input, DO = digital output, AI = analog input, ARTN = analog signal return, PWR = power supply, PGND = power ground, PBY = power bypass, PO = power output, AG = analog ground, DG = digital ground, CP = charge pump.

ABSOLUTE MAXIMUM RATINGS

over operating free-air temperature range (unless otherwise noted)

			VALUE	UNIT
PVDD	DC supply voltage range	Relative to GND	–0.3 to 30	V
PVDD _{MAX}	Pulsed supply voltage range	t ≤ 100 ms exposure	–1 to 50	V
PVDD _{RAMP}	Supply voltage ramp rate		15	V/ms
I _{PVDD}	Externally imposed dc supply current per PVDD or GND pin		±12	A
I _{PVDD_MAX}	Pulsed supply current per PVDD pin (one shot)	t < 100 ms	17	A
I _O	Maximum allowed dc current per output pin		±13.5	A
I _{O_MAX} ⁽¹⁾	Pulsed output current per output pin (single pulse)	t < 100 ms	±17	A
I _{IN_MAX}	Maximum current, all digital and analog input pins ⁽²⁾	DC or pulsed	±1	mA
I _{MUTE_MAX}	Maximum current on $\overline{\text{MUTE}}$ pin	DC or pulsed	±20	mA
I _{IN_ODMAX}	Maximum sinking current for open-drain pins		7	mA
V _{LOGIC}	Input voltage range for logic pin relative to GND (SCL and SDA pins)	Supply voltage range: 6.5 V < PVDD < 24 V	–0.3 to 7	V
V _{I2C_ADDR}	Input voltage range for I2C_ADDR pin relative to GND	Supply voltage range: 6.5 V < PVDD < 24 V	–0.3 to 7	V
V _{STANDBY}	Input voltage range for $\overline{\text{STANDBY}}$ pin	Supply voltage range: 6.5 V < PVDD < 24 V	–0.3 to 5.5	V
V _{OSC_SYNC}	Input voltage range for OSC_SYNC pin relative to GND	Supply voltage range: 6.5 V < PVDD < 24 V	–0.3 to 3.6	V
V _{AIN_MAX}	Maximum instantaneous input voltage (per pin), analog input pins	Supply voltage range: 6.5 V < PVDD < 24 V	6.5	V
V _{AIN_AC_MAX_5414}	Maximum ac-coupled input voltage for TAS5414A ⁽²⁾ , analog input pins	Supply voltage range: 6.5 V < PVDD < 24 V	0 to 6.5	V
V _{AIN_AC_MAX_5424}	Maximum ac-coupled differential input voltage for TAS5424A ⁽²⁾ , analog input pins	Supply voltage range: 6.5 V < PVDD < 24 V	0 to 6.5	V
V _{AIN_DC}	Input voltage range for analog pin relative to GND (INx pins)	Supply voltage range: 6.5 V < PVDD < 24 V	–0.3 to 6.5	V
V _{GND}	Maximum voltage between GND pins		±0.3	V
T _J	Maximum operating junction temperature range		–55 to 150	°C
T _{stg}	Storage temperature range		–55 to 150	°C
Power dissipation	Continuous power dissipation	T _{case} = 70°C	80	W

(1) Pulsed current ratings are maximum survivable currents externally applied to the TAS5414A and TAS5424A. High currents may be encountered during reverse battery, fortuitous open ground, and fortuitous open supply fault conditions.

(2) See [Application Information](#) section for information on analog input voltage and ac coupling.

THERMAL CHARACTERISTICS

PARAMETER		VALUE (Typical)	UNIT
R _{θJC}	Junction-to-case (heat slug) thermal resistance, DKD package	1	°C/W
R _{θJC}	Junction-to-case (heat slug) thermal resistance, PHD package	1.2	°C/W
R _{θJA}	Junction-to-ambient thermal resistance	This device is not intended to be used without a heatsink. Therefore, R _{θJA} is not specified. See the Thermal Information section.	°C/W
	Exposed pad dimensions, DKD package	13.8 × 5.8	mm
	Exposed pad dimensions, PHD package	8 × 8	mm

RECOMMENDED OPERATING CONDITIONS⁽¹⁾

		MIN	TYP	MAX	UNIT
PVDD _{OP}	DC supply voltage range relative to GND	8	14.4	22	V
PVDD _{I2C}	DC supply voltage range for I ² C reporting	6	14.4	26.5	V

(1) The *Recommended Operating Conditions* table specifies only that the device is functional in the given range. See the *Electrical Characteristics* table for specified performance limits.

TAS5414A, TAS5424A

SLOS535C –MAY 2009–REVISED APRIL 2011

www.ti.com

RECOMMENDED OPERATING CONDITIONS⁽¹⁾ (continued)

			MIN	TYP	MAX	UNIT
V_{AIN_5414} ⁽²⁾	Analog audio input signal level (TAS5414A)	AC-coupled input voltage	0		0.25–1 ⁽³⁾	Vrms
V_{AIN_5424} ⁽²⁾	Analog audio input signal level (TAS5424A)	AC-coupled input voltage	0		0.5–2 ⁽³⁾	Vrms
f_{AUDIO_TW}	Audio frequency for tweeter detect		10	20	25	kHz
T_A	Ambient temperature		–40		105	°C
T_J	Junction temperature	An adequate heat sink is required to keep T_J within specified range.	–40		115	°C
R_L	Nominal speaker load impedance		2	4		Ω
V_{PU}	Pullup voltage supply (for open-drain logic outputs)		3	3.3 or 5	5.5	V
R_{PU_EXT}	External pullup resistor on open-drain logic outputs	Resistor connected between open-drain logic output and V_{PU} supply	10	47	100	k Ω
R_{PU_I2C}	I ² C pullup resistance on SDA and SCL pins		1	4.7	10	k Ω
R_{I2C_ADD}	Total resistance of voltage divider for I ² C address slave 1 or slave 2, connected between D_BYP and GND pins		10		100	k Ω
R_{REXT}	External resistance on REXT pin	1% tolerance required	19.8	20	20.2	k Ω
C_{D_BYP}	External capacitance on D_BYP pin		10		120	nF
C_{A_BYP}	External capacitance on A_BYP pin		10		120	nF
C_{IN}	External capacitance to analog input pin in series with input signal			1		μ F
C_{FLY}	Flying capacitor on charge pump		0.47	1	1.5	μ F
C_P	Charge pump capacitor		0.47	1	1.5	μ F
C_{MUTE}	Capacitance on MUTE pin		100	330		nF
$C_{OSCSYNC_MAX}$	Allowed loading capacitance on OSC_SYNC pin			5		pF

(2) Signal input for full unclipped output with gains of 32 dB, 26 dB, 20 dB, and 12 dB

(3) Maximum recommended input voltage is determined by the gain setting.

ELECTRICAL CHARACTERISTICS

Test conditions (unless otherwise noted): $T_{Case} = 25^{\circ}C$, $PVDD = 14.4 V$, $R_L = 4 \Omega$, $f_S = 417 kHz$, $P_{out} = 1 W/ch$, $R_{ext} = 20 k\Omega$, AES17 Filter, master mode operation (see application diagram)

PARAMETER		TEST CONDITIONS	MIN	TYP	MAX	UNIT
OPERATING CURRENT						
I_{PVDD_IDLE}	PVDD idle current	All four channels running in MUTE mode		240	300	mA
I_{PVDD_HI-Z}		All four channels in Hi-Z mode		80		
I_{PVDD_STBY}	PVDD standby current	STANDBY mode, $T_J \leq 85^{\circ}C$		2	20	μA
OUTPUT POWER						
P_{OUT}	Output power per channel	4 Ω , PVDD = 14.4 V, THD+N $\leq 1\%$, 1 kHz, $T_c = 75^{\circ}C$		23		W
		4 Ω , PVDD = 14.4 V, THD+N = 10%, 1 kHz, $T_c = 75^{\circ}C$	25	28		
		4 Ω , PVDD = 14.4 V, square wave, 1 kHz, $T_c = 75^{\circ}C$		43		
		4 Ω , PVDD = 21 V, THD+N = 1%, 1 kHz, $T_c = 75^{\circ}C$		47		
		4 Ω , PVDD = 21 V, THD+N = 10%, 1 kHz, $T_c = 75^{\circ}C$	50	58		
		2 Ω , PVDD = 14.4 V, THD+N = 1%, 1 kHz, $T_c = 75^{\circ}C$		38		
		2 Ω , PVDD = 14.4 V, THD+N = 10%, 1 kHz, $T_c = 75^{\circ}C$	40	45		
		2 Ω , PVDD = 14.4 V, square wave 1 kHz, $T_c = 75^{\circ}C$		70		
		PBTL 2- Ω operation, PVDD = 21 V, THD+N = 10%, 1 kHz, $T_c = 75^{\circ}C$		116		
		PBTL 1- Ω operation, PVDD = 14.4 V, THD+N = 10%, 1 kHz, $T_c = 75^{\circ}C$		90		
EFF_P	Power efficiency	4 channels operating, 23-W output power/ch, $L = 10 \mu H$, $T_J \leq 85^{\circ}C$		90%		
AUDIO PERFORMANCE						
V_{NOISE}	Noise voltage at output	$G = 26 dB$, zero input, and A-weighting		60	100	μV
Crosstalk	Channel crosstalk	1 W, $G = 26 dB$, 1 kHz	60	75		dB
$CMRR_{5424}$	Common-mode rejection ratio (TAS5424A)	1 kHz, 1 V _{rms} referenced to GND, $G = 26 dB$	60	75		dB
PSRR	Power supply rejection ratio	$G = 26 dB$, PVDD = 14.4 Vdc + 1 V _{rms} , $f = 1 kHz$	60	75		dB
THD+N	Total harmonic distortion + noise	$P = 1 W$, $G = 26 dB$, $f = 1 kHz$, $0^{\circ}C \leq T_J \leq 75^{\circ}C$		0.02%	0.1%	
f_S	Switching frequency	Switching frequency selectable for AM interference avoidance	336	357	378	kHz
			392	417	442	
			470	500	530	
R_{AIN}	Analog input resistance	Internal shunt resistance on each input pin	60	80	100	k Ω
V_{CM_INT}	Internal common-mode input bias voltage	Internal bias applied to IN_M pin		3.25		V
G	Voltage gain (V_O/V_{IN})	Source impedance = 0 Ω , gain measurement taken at 1 W of power per channel	11	12	13	dB
			19	20	21	
			25	26	27	
			31	32	33	
G_{CH}	Channel-to-channel variation	Any gain commanded	-1	0	1	dB
t_{CM}	Output-voltage common-mode ramping time	External $C_{MUTE} = 330 nF$		35		ms
t_{GAIN}	Gain ramping time	External $C_{MUTE} = 330 nF$		30		ms
PWM OUTPUT STAGE						
$R_{DS(on)}$	FET drain-to-source resistance	Not including bond wire resistance, $T_J = 25^{\circ}C$		75	95	m Ω
V_{O_OFFSET}	Output offset voltage	Zero input signal, dc offset reduction enabled, and $G = 26 dB$		± 10	± 25	mV
PVDD OVERVOLTAGE (OV) PROTECTION						
V_{OV}	PVDD overvoltage shutdown		22.1	23.7	26.3	V
LOAD DUMP (LD) PROTECTION						
$V_{LD_SD_SET}$	Load-dump shutdown voltage		26.6	29	32	V
$V_{LD_SD_CLEAR}$	Recovery voltage for load-dump shutdown		23.5	26.4	28.4	V
PVDD UNDERVOLTAGE (UV) PROTECTION						
V_{UV_SET}	PVDD undervoltage shutdown		6.5	7	7.5	V
V_{UV_CLEAR}	Recovery voltage for PVDD UV		7	7.5	8	V
AVDD						
V_{A_BYP}	A_BYP pin voltage			6.5		V

TAS5414A, TAS5424A

SLOS535C –MAY 2009–REVISED APRIL 2011

www.ti.com

ELECTRICAL CHARACTERISTICS (continued)

Test conditions (unless otherwise noted): $T_{Case} = 25^{\circ}C$, $PVDD = 14.4 V$, $R_L = 4 \Omega$, $f_S = 417 kHz$, $P_{out} = 1 W/ch$, $R_{ext} = 20 k\Omega$, AES17 Filter, master mode operation (see application diagram)

PARAMETER		TEST CONDITIONS	MIN	TYP	MAX	UNIT
$V_{A_BYP_UV_SET}$	A_BYP UV voltage			4.8		V
$V_{A_BYP_UV_CLEAR}$	Recovery voltage A_BYP UV			5.3		V
DVDD						
V_{D_BYP}	D_BYP pin voltage			3.3		V
POWER-ON RESET (POR)						
V_{POR}	Maximum PVDD voltage for POR; I ² C active above this voltage				6	V
V_{POR_HY}	PVDD recovery hysteresis voltage for POR			0.1		V
REXT						
V_{REXT}	Rext pin voltage			1.24		V
CHARGE PUMP (CP)						
V_{CPUV_SET}	CP undervoltage			4.8		V
V_{CPUV_CLEAR}	Recovery voltage for CP UV			5.2		V
OVERTEMPERATURE (OT) PROTECTION						
T_{OTW1_CLEAR}	Junction temperature for overtemperature warning		102	115	128	°C
$T_{OTW1_SET} / T_{OTW2_CLEAR}$			112	125	138	
$T_{OTW2_SET} / T_{OTW3_CLEAR}$			122	135	148	
$T_{OTW3_SET} / T_{OTSD_CLEAR}$			132	145	158	
T_{OTSD}	Junction temperature for overtemperature shutdown		142	155	168	
CURRENT LIMITING PROTECTION						
I_{LIM1}	Current limit 1 (load current)	Load < 4 Ω	5.5	7.3	9	A
I_{LIM2}	Current limit 2 (load current), through I ² C setting	Load < 2 Ω	8.5	11	13.5	A
OVERCURRENT (OC) SHUTDOWN PROTECTION						
I_{MAX1}	Maximum current 1 (peak output current)	Any short to supply, ground, or other channels	9.5	11.3	13	A
I_{MAX2}	Maximum current 2 (peak output current)		11.5	14.3	17	A
TWEETER DETECT						
I_{TH_TW}	Load current threshold for tweeter detect		325	540	750	mA
I_{LIM_TW}	Load current limit for tweeter detect			2		A
STANDBY MODE						
V_{IH_STBY}	$\overline{STANDBY}$ input voltage for logic-level high		2		5.5	V
V_{IL_STBY}	$\overline{STANDBY}$ input voltage for logic-level low		0		0.7	V
I_{STBY_PIN}	$\overline{STANDBY}$ pin current			0.1	0.2	μA
MUTE MODE						
G_{MUTE}	Output attenuation	\overline{MUTE} pin $\leq 0.9 V_{dc}$, $V_{IN} = 1 V_{rms}$ on all inputs		85		dB
DC DETECT						
$V_{TH_DCD_POS}$	DC detect positive threshold default value	PVDD = 14.4 Vdc, register 0x0E = 8EH		6.5		V
$V_{TH_DCD_NEG}$	DC detect negative threshold default value	PVDD = 14.4 Vdc, register 0x0F = 3DH		-6.5		V
t_{DCD}	DC detect step response time for four channels				4.3	s
CLIP_OTW REPORT						
$V_{OH_CLIPOTW}$	$\overline{CLIP_OTW}$ pin output voltage for logic level high (open-drain logic output)	External 47-k Ω pullup resistor to 3 V–5.5 V	2.4			V
$V_{OL_CLIPOTW}$	$\overline{CLIP_OTW}$ pin output voltage for logic level low (open-drain logic output)				0.5	
$t_{DELAY_CLIPDET}$	$\overline{CLIP_OTW}$ signal delay when output clipping detected			20		μs
FAULT REPORT						

ELECTRICAL CHARACTERISTICS (continued)

Test conditions (unless otherwise noted): $T_{Case} = 25^{\circ}C$, $PVDD = 14.4 V$, $R_L = 4 \Omega$, $f_S = 417 kHz$, $P_{out} = 1 W/ch$, $R_{ext} = 20 k\Omega$, AES17 Filter, master mode operation (see application diagram)

PARAMETER		TEST CONDITIONS	MIN	TYP	MAX	UNIT
V_{OH_FAULT}	\overline{FAULT} pin output voltage for logic-level high (open-drain logic output)	External 47-k Ω pullup resistor to 3 V–5.5 V	2.4			V
V_{OL_FAULT}	\overline{FAULT} pin output voltage for logic-level low (open-drain logic output)				0.5	
OPEN/SHORT DIAGNOSTICS						
R_{S2P} , R_{S2G}	Maximum resistance to detect a short from OUT pin(s) to PVDD or ground				200	Ω
R_{OPEN_LOAD}	Minimum load resistance to detect open circuit	Including speaker wires	300	800	1300	Ω
$R_{SHORTED_LOAD}$	Maximum load resistance to detect short circuit	Including speaker wires	0.5	1	1.5	Ω
I²C ADDRESS DECODER						
$t_{LATCH_I2CADDR}$	Time delay to latch I ² C address after POR			300		μs
V_{I2C_ADDR}	Voltage on I2C_ADDR pin for address 0	Connect to GND	0%	0%	15%	V_{D_BYP}
	Voltage on I2C_ADDR pin for address 1	External resistors in series between D_BYP and GND as a voltage divider	25%	35%	45%	
	Voltage on I2C_ADDR pin for address 2		55%	65%	75%	
	Voltage on I2C_ADDR pin for address 3	Connect to D_BYP	85%	100%	100%	
I²C						
t_{HOLD_I2C}	Power-on hold time before I ² C communication	$\overline{STANDBY}$ high		1		ms
f_{SCL}	SCL clock frequency				100	kHz
V_{IH_SCL}	SCL pin input voltage for logic-level high	$R_{PU_I2C} = 5\text{-k}\Omega$ pullup, supply voltage = 3.3 V or 5 V	2.1		5.5	V
V_{IL_SCL}	SCL pin input voltage for logic-level low		–0.5		1.1	V
V_{OH_SDA}	SDA pin output voltage for logic-level high	I ² C read, $R_{I2C} = 5\text{-k}\Omega$ pullup, supply voltage = 3.3 V or 5 V	2.4			V
V_{OL_SDA}	SDA pin output voltage for logic-level low	I ² C read, 3-mA sink current	0		0.4	V
V_{IH_SDA}	SDA pin input voltage for logic-level high	I ² C write, $R_{I2C} = 5\text{-k}\Omega$ pullup, supply voltage = 3.3 V or 5 V	2.1		5.5	V
V_{IL_SDA}	SDA pin input voltage for logic-level low	I ² C write, $R_{I2C} = 5\text{-k}\Omega$ pullup, supply voltage = 3.3 V or 5 V	–0.5		1.1	V
C_I	Capacitance for SCL and SDA pins				10	pF
OSCILLATOR						
$V_{OH_OSCSYNC}$	OSC_SYNC pin output voltage for logic-level high	I2C_ADDR pin set to MASTER mode	2.4		3.6	V
$V_{OL_OSCSYNC}$	OSC_SYNC pin output voltage for logic-level low				0.5	
$V_{IH_OSCSYNC}$	OSC_SYNC pin input voltage for logic-level high	I2C_ADDR pin set to SLAVE mode	2		3.6	V
$V_{IL_OSCSYNC}$	OSC_SYNC pin input voltage for logic-level low				0.8	
f_{OSC_SYNC}	OSC_SYNC pin clock frequency	I2C_ADDR pin set to MASTER mode, $f_S = 500 kHz$	3.76	4.0	4.24	MHz
		I2C_ADDR pin set to MASTER mode, $f_S = 417 kHz$	3.13	3.33	3.63	
		I2C_ADDR pin set to MASTER mode, $f_S = 357 kHz$	2.68	2.85	3.0	

TIMING REQUIREMENTS FOR I²C INTERFACE SIGNALS

over recommended operating conditions (unless otherwise noted)

PARAMETER		MIN	TYP	MAX	UNIT
t_r	Rise time for both SDA and SCL signals			1000	ns
t_f	Fall time for both SDA and SCL signals			300	ns
$t_{w(H)}$	SCL pulse duration, high	4			μ s
$t_{w(L)}$	SCL pulse duration, low	4.7			μ s
t_{su2}	Setup time for START condition	4.7			μ s
t_{h2}	START condition hold time after which first clock pulse is generated	4			μ s
t_{su1}	Data setup time	250			ns
t_{h1}	Data hold time	0 ⁽¹⁾			ns
t_{su3}	Setup time for STOP condition	4			μ s
C_B	Load capacitance for each bus line			400	pF

(1) A device must internally provide a hold time of at least 300 ns for the SDA signal to bridge the undefined region of the falling edge of SCL.

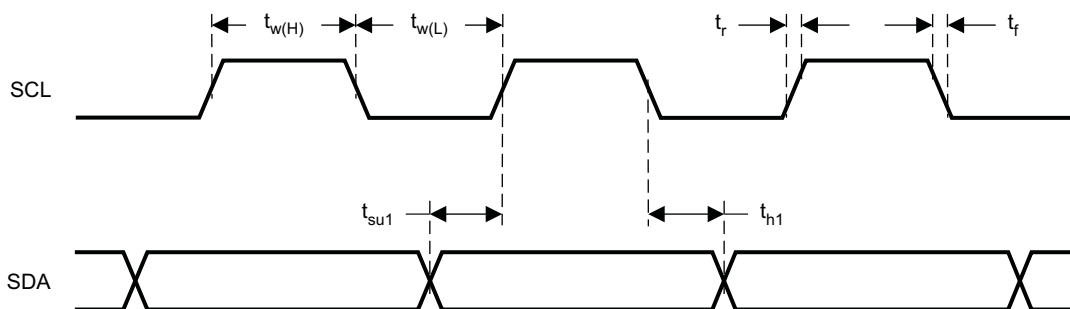

T0027-01

Figure 1. SCL and SDA Timing

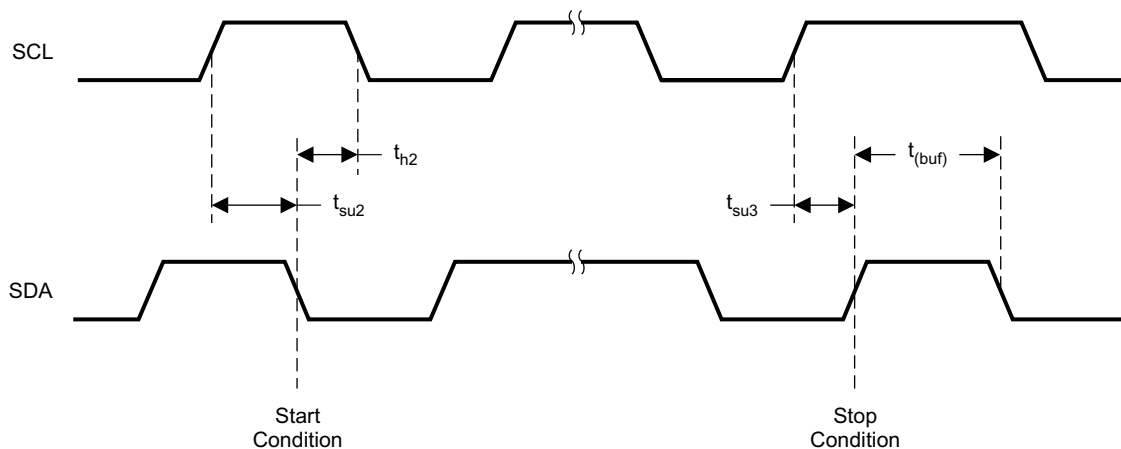

T0028-01

Figure 2. Timing for Start and Stop Conditions

TYPICAL CHARACTERISTICS

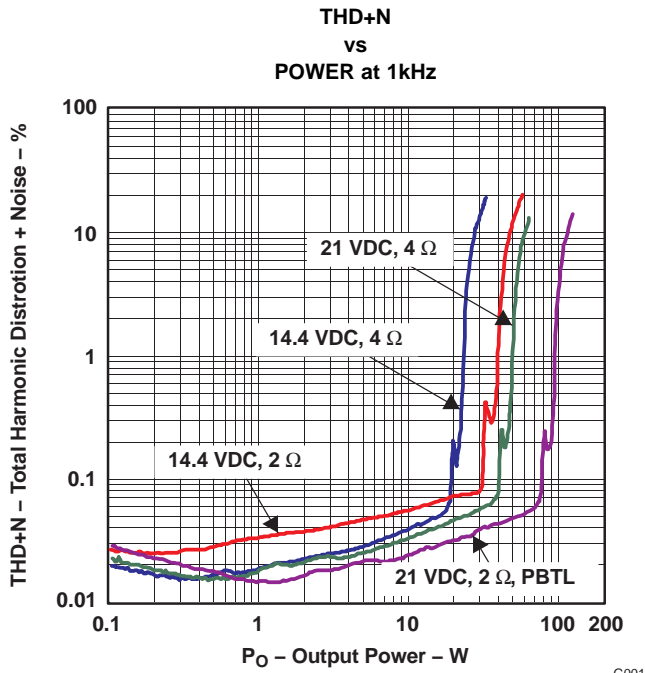

Figure 3.

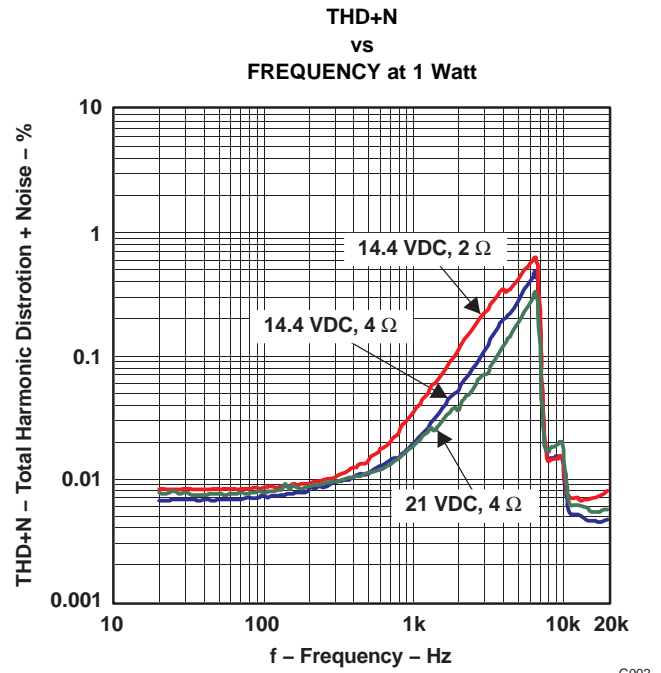

Figure 4.

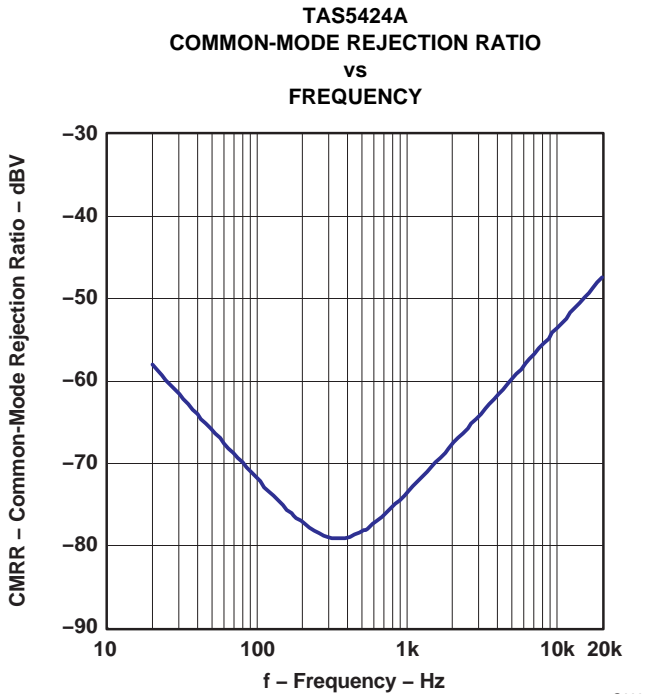

Figure 5.

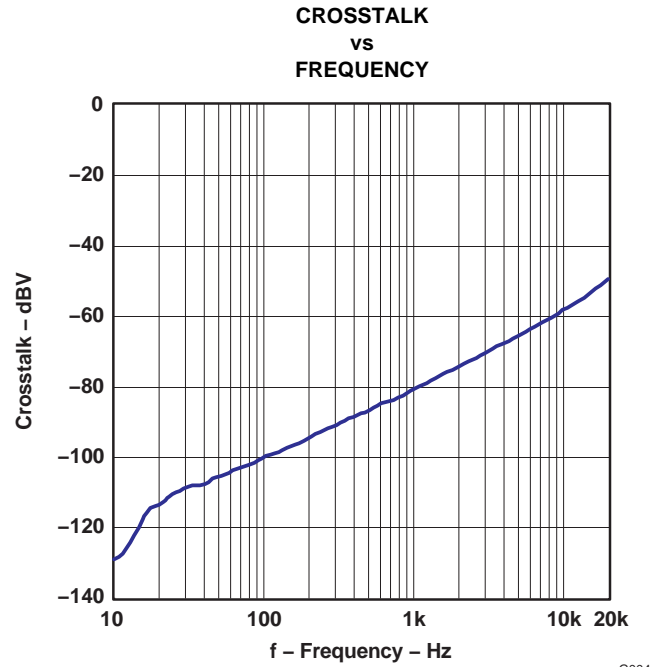

Figure 6.

TYPICAL CHARACTERISTICS (continued)

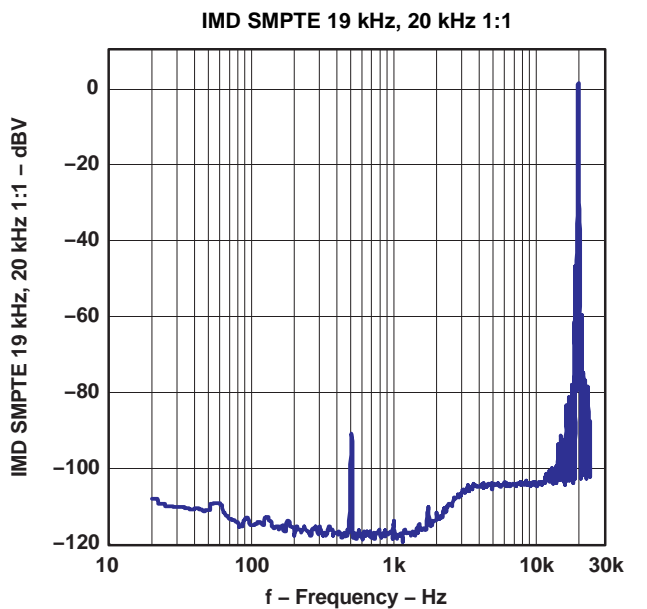

Figure 7.

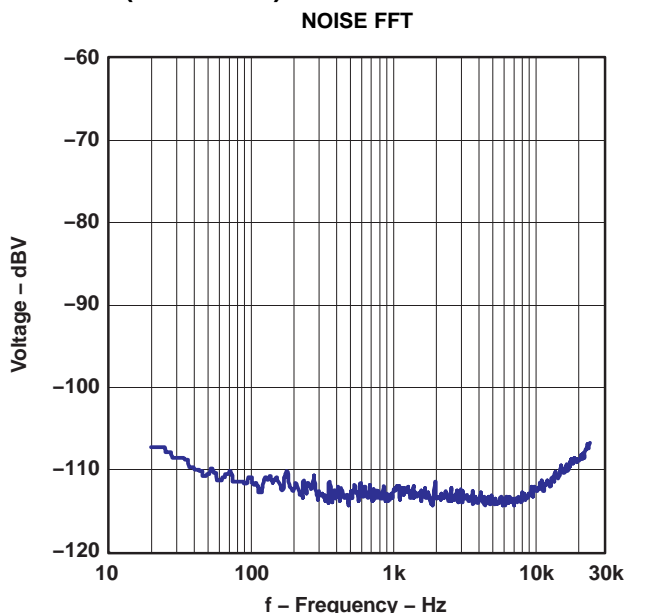

Figure 8.

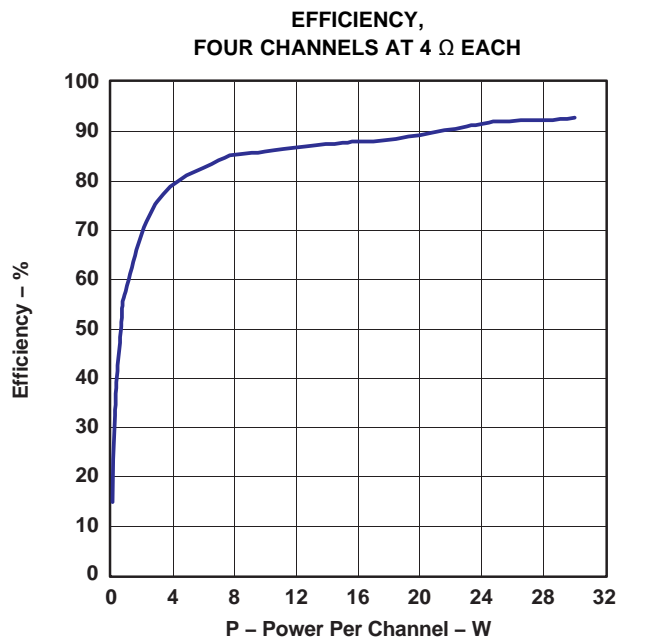

Figure 9.

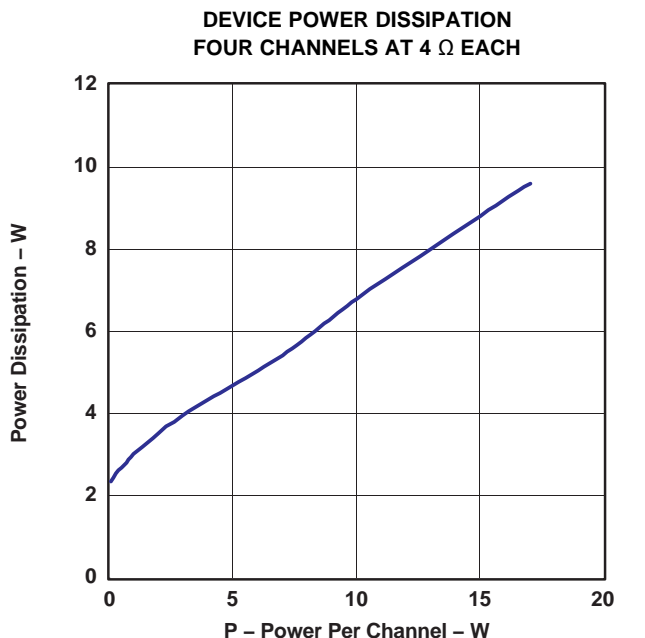

Figure 10.

TYPICAL CHARACTERISTICS (continued)

DC DETECT VOLTAGE
vs
REGISTER 0E VALUES

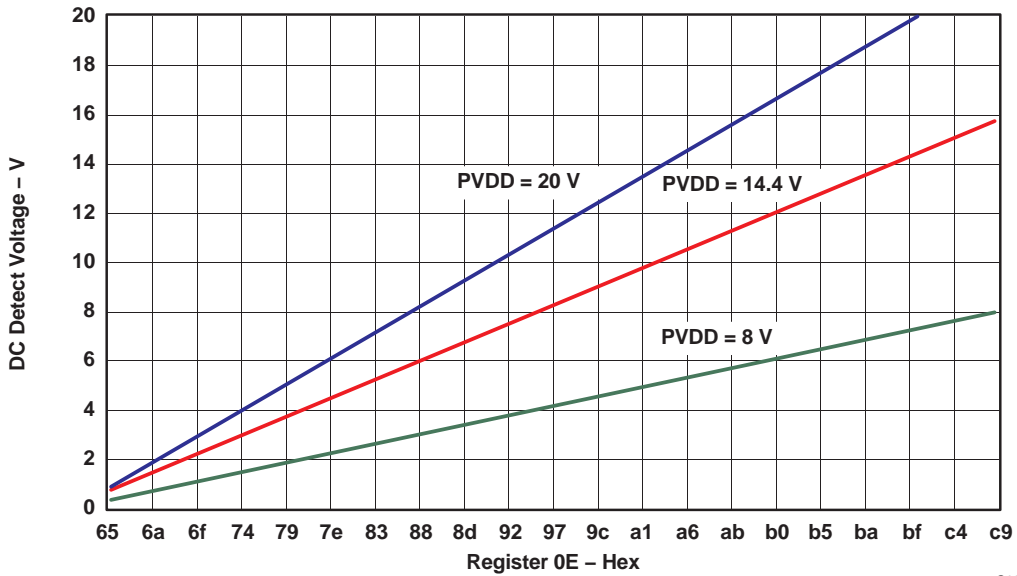

Figure 11.

G009

DC DETECT VOLTAGE
vs
REGISTER 0F VALUES

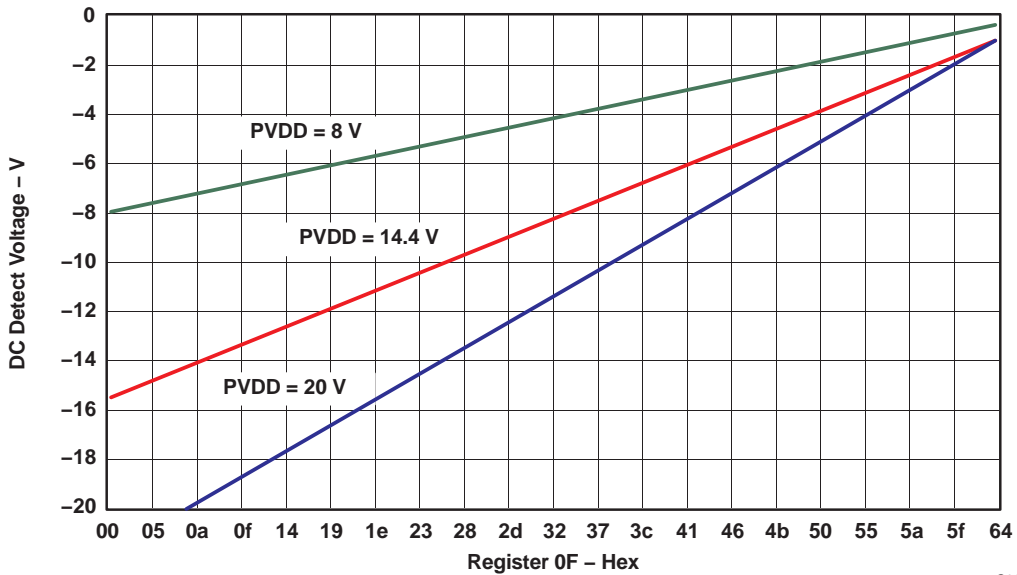

Figure 12.

G010

DESCRIPTION OF OPERATION

OVERVIEW

The TAS5414A and TAS5424A are single-chip, four-channel, analog-input audio amplifiers for use in the automotive environment. The design uses an ultra-efficient class-D technology developed by Texas Instruments, but with changes needed by the automotive industry. This technology allows for reduced power consumption, reduced heat, and reduced peak currents in the electrical system. The TAS5414A and TAS5424A realize an audio sound system design with smaller size and lower weight than traditional class-AB solutions.

The TAS5414A and TAS5424A are composed of eight elements:

- Preamplifier
- PWM
- Gate drive
- Power FETs
- Diagnostics
- Protection
- Power supply
- I²C serial communication bus

Preamplifier

The preamplifier of the TAS5414A and TAS5424A is a high-input-impedance, low-noise, low-offset-voltage input stage with adjustable gain. The high input impedance of the TAS5414A and TAS5424A allows the use of low-cost 1- μ F input capacitors while still achieving extended low-frequency response. The preamplifier is powered by a dedicated, internally regulated supply, which gives it excellent noise immunity and channel separation. Also included in the preamp are:

1. **Mute Pop-and-Click Control**—An audio input signal is reshaped and amplified as a step when a mute is applied at the crest or trough of the signal. Such a step is perceived as a loud click. This is avoided in the TAS5414A and TAS5424A by ramping the gain gradually when a mute or play command is received. Another form of click and pop can be caused by the start or stopping of switching in a class-D amplifier. The TAS5414A and TAS5424A incorporate a patented method to reduce the pop energy during the switching startup and shutdown sequence. Fault conditions require rapid protection response by the TAS5414A and the TAS5424A, which do not have time to ramp the gain down in a pop-free manner. The device transitions into Hi-Z mode when an OV, UV, OC, OT, or DC fault is encountered. Also, activation of the STANDBY pin may not be pop-free.
2. **Gain Control**—The four gain settings are set in the preamplifier via I²C control registers. The gain is set outside of the global feedback resistors of the TAS5414A and the TAS5424A, thus allowing for stability in the system all gain settings with properly loaded conditions.
3. **DC Offset Reduction Circuitry**—Circuitry has been incorporated to reduce the dc offset. DC offset in high-gain amplifiers can produce audible clicks and pops when the amplifier is started or stopped. The offset reduction circuitry can be disabled or enabled via I²C.

Pulse-Width Modulator (PWM)

The PWM converts the analog signal from the preamplifier into a switched signal of varying duty cycle. This is the critical stage that defines the class-D architecture. In the TAS5414A and TAS5424A, the modulator is an advanced design with high bandwidth, low noise, low distortion, excellent stability, and full 0–100% modulation capability. The patented PWM uses clipping recovery circuitry to eliminate the deep saturation characteristic of PWMs when the input signal exceeds the modulator waveform.

Gate Drive

The gate driver accepts the low-voltage PWM signal and level shifts it to drive a high-current, full-bridge, power FET stage. The TAS5414A and TAS5424A use patent-pending techniques to avoid shoot-through and are optimized for EMI and audio performance.

Power FETs

The BTL output for each channel comprises four rugged N-channel 30-V FETs, each of which has an $R_{DS(on)}$ of 75 m Ω for high efficiency and maximum power transfer to the load. These FETs are designed to handle large voltage transients during load dump.

Load Diagnostics

The TAS5414A and TAS5424A incorporate load diagnostic circuitry designed to help pinpoint the nature of output misconnections during installation. The TAS5414A and the TAS5424A include functions for detecting and determining the status of output connections. The following diagnostics are supported:

- Short to GND
- Short to PVDD
- Short across load ($R < 1 \Omega$, typical)
- Open load ($R > 800 \Omega$, typical)
- Tweeter detection

The presence of any of the short or open conditions is reported to the system via I²C register read. The tweeter detect status can be read from the CLIP_OTW pin when properly configured.

1. **Output Short and Open Diagnostics**—The TAS5414A and TAS5424A contain circuitry designed to detect shorts and open conditions on the outputs. The load diagnostic function can only be invoked when the output is in the Hi-Z mode. There are four phases of test during load diagnostics and two levels of test. In the full level, all channels must be in the Hi-Z state. All four phases are tested on each channel, all four channels at the same time. When fewer than four channels are in Hi-Z, the reduced level of test is the only available option. In the reduced level, only short to PVDD and short to GND can be tested. Load diagnostics can occur at power up before the amplifier is moved out of Hi-Z mode. If the amplifier is already in play mode, it must *Mute* and then *Hi-Z* before the load diagnostic can be performed. By performing the mute function, the normal pop- and click-free transitions occur before the diagnostics begin. The diagnostics are performed as shown in Figure 13. Figure 14 shows the impedance ranges for the open-load and shorted-load diagnostics. The results of the diagnostic are read from the diagnostic register for each channel via I²C. **Note:** Do not send a command via I²C to register 0x0C during the load diagnostic test.

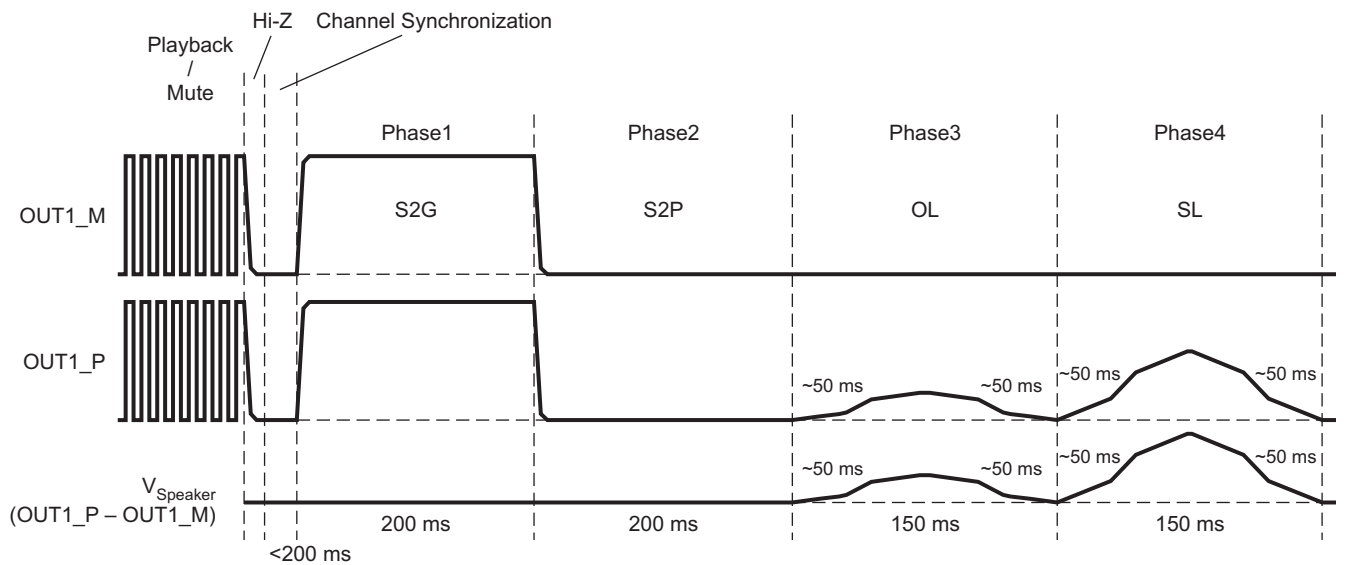

T0188-01

Figure 13. Load Diagnostics Sequence of Events

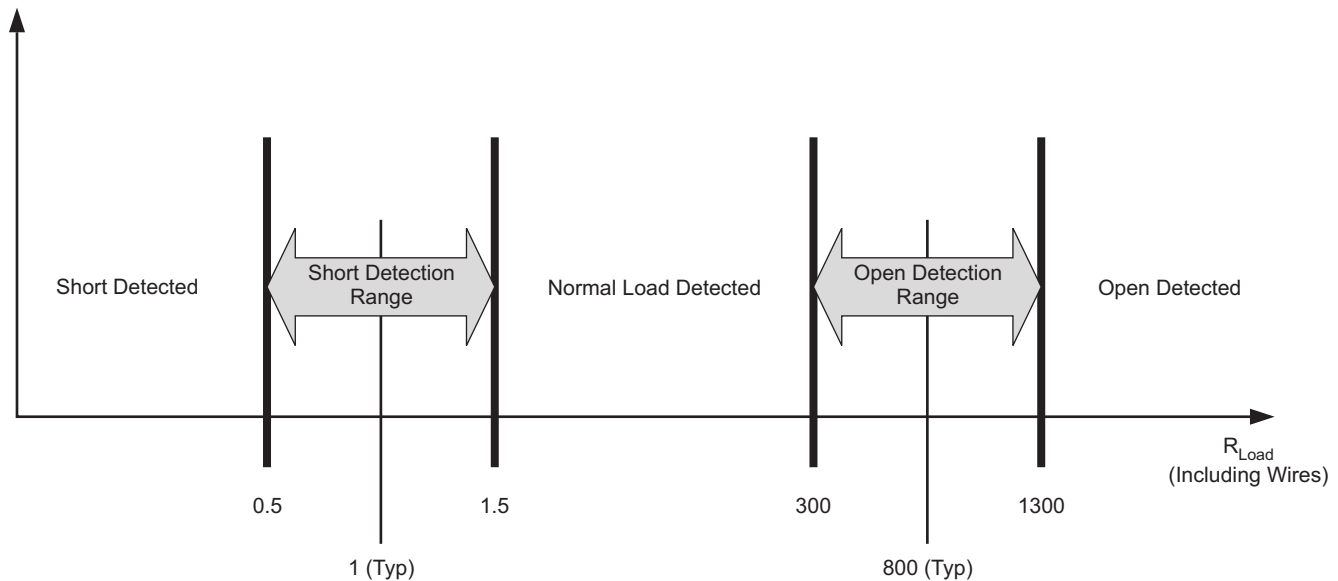

M0067-01

Figure 14. Open and Shorted Load Detection

- 2. Tweeter Detection**— Tweeter detection is an alternate operating mode that is used to determine the proper connection of a frequency dependent load (such as a speaker with a crossover). Tweeter detection is invoked via I²C, and all four channels should be tested individually. Tweeter detection uses the average cycle-by-cycle current limit circuit (see [CBC](#) section) to measure the current delivered to the load. The proper implementation of this diagnostic function is dependent on the amplitude of a user-supplied test signal and on the impedance versus frequency curve of the acoustic load. The system (external to the TAS5414A and TAS5424A) must generate a signal to which the load will respond. The frequency and amplitude of this signal must be calibrated by the user to result in a current draw that is greater than the tweeter detection threshold when the load under test is present, and less than the detection threshold if the load is not properly connected. The current level for the tweeter detection threshold, as well as the maximum current that can safely be delivered to a load when in tweeter detection mode, can be found in the Electrical Characteristics section of the datasheet. The tweeter detection results are reported on the CLIP_OTW pin during the application of the test signal. When tweeter detection is activated (indicating that the tested load is present), pulses on the CLIP_OTW pin begin to toggle. The pulses on the CLIP_OTW pins will report low whenever the current detection threshold is exceeded, and the pin will remain low until the threshold is no longer exceeded. The minimum low-pulse period that can be expected is equal to one period of the switching frequency. Having an input signal that increases the amount of time that the detector is activated (e. g. increasing the amplitude of the input signal) will increase the amount of time for which the pin reports low. **NOTE:** Because tweeter detection is an alternate *operating mode*, the channels to be tested must be placed in Play mode (via register 0x0C) after tweeter detection has been activated in order to commence the detection process. Additionally, the CLIP_OTW pin must be set up via register 0x0A to report the results of tweeter detection.

Protection and Monitoring

- 1. Cycle-By-Cycle Current Limit (CBC)**—The CBC current-limiting circuit terminates each PWM pulse to limit the output current flow when the average current limit (I_{LIM}) threshold is exceeded. The overall effect on the audio in the case of a current overload is quite similar to a voltage-clipping event, where power is temporarily limited at the peaks of the musical signal and normal operation continues without disruption when the overload is removed. The TAS5414A and TAS5424A do not prematurely shut down in this condition. All four channels continue in play mode and pass signal.
- 2. Overcurrent Shutdown (OCS)**—Under severe short-circuit events, such as a short to PVDD or ground, a peak-current detector is used, and the affected channel shuts down in 200 μ s to 390 μ s if the conditions are severe enough. The shutdown speed depends on a number of factors, such as the impedance of the short circuit, supply voltage, and switching frequency. Only the shorted channels are shut down in such a scenario.

The user may restart the affected channel via I²C. An OCS event activates the fault pin, and the affected channel(s) are recorded in the I²C fault register. If the supply or ground short is strong enough to exceed the peak current threshold but not severe enough to trigger the OCS, the peak current limiter prevents excess current from damaging the output FETs, and operation returns to normal after the short is removed.

3. **DC Detect**—This circuit detects a dc offset continuously during normal operation at the output of the amplifier. If the dc offset reaches the level defined in the I²C registers for the specified time period, the circuit triggers. By default a dc detection event does not shut the output down. The shutdown function can be enabled or disabled via I²C. If enabled, the triggered channel shuts down, but the others remain playing and the $\overline{\text{FAULT}}$ pin is asserted. The positive dc level and negative dc level are defined in I²C registers and can have separate thresholds.
4. **Clip Detect**—The clip detect circuit alerts the user to the presence of a 100% duty-cycle PWM due to a clipped waveform. When this occurs, a signal is passed to the $\overline{\text{CLIP_OTW}}$ pin and it is asserted until the 100% duty-cycle PWM signal is no longer present. All four channels are connected to the same $\overline{\text{CLIP_OTW}}$ pin. Through I²C, the $\overline{\text{CLIP_OTW}}$ signal can be changed to clip-only, OTW-only, or both. A fourth mode, used only during diagnostics, is the option to report tweeter detection events on this pin (see the [Tweeter Detection](#) section). The microcontroller in the system can monitor the signal at the $\overline{\text{CLIP_OTW}}$ pin and may be configured to reduce the volume to all four channels in an active clipping-prevention circuit.
5. **Overtemperature Warning (OTW) and Overtemperature Shutdown (OTSD)**—By default, the $\overline{\text{CLIP_OTW}}$ pin is set to indicate an OTW. This can be changed via I²C commands. If selected to indicate a temperature warning, the $\overline{\text{CLIP_OTW}}$ pin is asserted when the die temperature reaches 125°C. The OTW has three temperature thresholds with a 10°C hysteresis. Each threshold is indicated in I²C register 0x04 bits 5, 6, and 7. The TAS5414A and TAS5424A still function until the temperature reaches the OTSD threshold, 155°C, at which time the outputs are placed into Hi-Z mode and the $\overline{\text{FAULT}}$ pin is asserted. I²C is still active in the event of an OTSD and the registers can be read for faults, but all audio ceases abruptly. The OTSD resets at 145°C, to allow the TAS5414A/5424A to be turned back on through I²C. The OTW is still indicated until the temperature drops below 115°C. All temperatures are nominal values.

CAUTION

CAUTIONARY NOTE: The PHD package version of the TAS5414A has a thermal weakness when any channel is outputting high current. The TAS5414A PHD may experience permanent thermal-related damage when high output current causes heating in the output stages of the device. Typical dangerous scenarios include shorted output loads and when delivering high power to low-impedance loads. The DKD versions of the TAS5414A and TAS5424A do not have this thermal weakness and are not at risk for damage due to these conditions. Please contact Texas Instruments directly for further application details.

6. **Undervoltage (UV) and Power-on-Reset (POR)**—The undervoltage (UV) protection detects low voltages on PVDD, AVDD, and CP. In the event of an undervoltage, the $\overline{\text{FAULT}}$ pin is asserted and the I²C register is updated, depending on which voltage caused the event. Power-on-reset (POR) occurs when PVDD drops low enough. A POR event causes the I²C to go into a high-impedance state. After the device recovers from the POR event, the device must be re-initialized via I²C.
7. **Overvoltage (OV) and Load Dump**—The OV protection detects high voltages on PVDD. If PVDD reaches the overvoltage threshold, the $\overline{\text{FAULT}}$ pin is asserted and the I²C register is updated. If the voltage increases beyond the load dump threshold of 29 Vdc, the device shuts down and must be restarted once the voltage returns to a safe value. After the device recovers from the \neq load dump event, the device must be re-initialized via I²C. The TAS5414A and TAS5424A can withstand 50-V load-dump voltage spikes (see [Figure 15](#)). Also depicted in this graph are the voltage thresholds for normal operation region, overvoltage operation region, and load-dump protection region. [Figure 13](#) shows the regions of operating voltage and the profile of the load dump event. Battery charger voltages from 25 V to 35 V can be withstood for up to 1 hour.

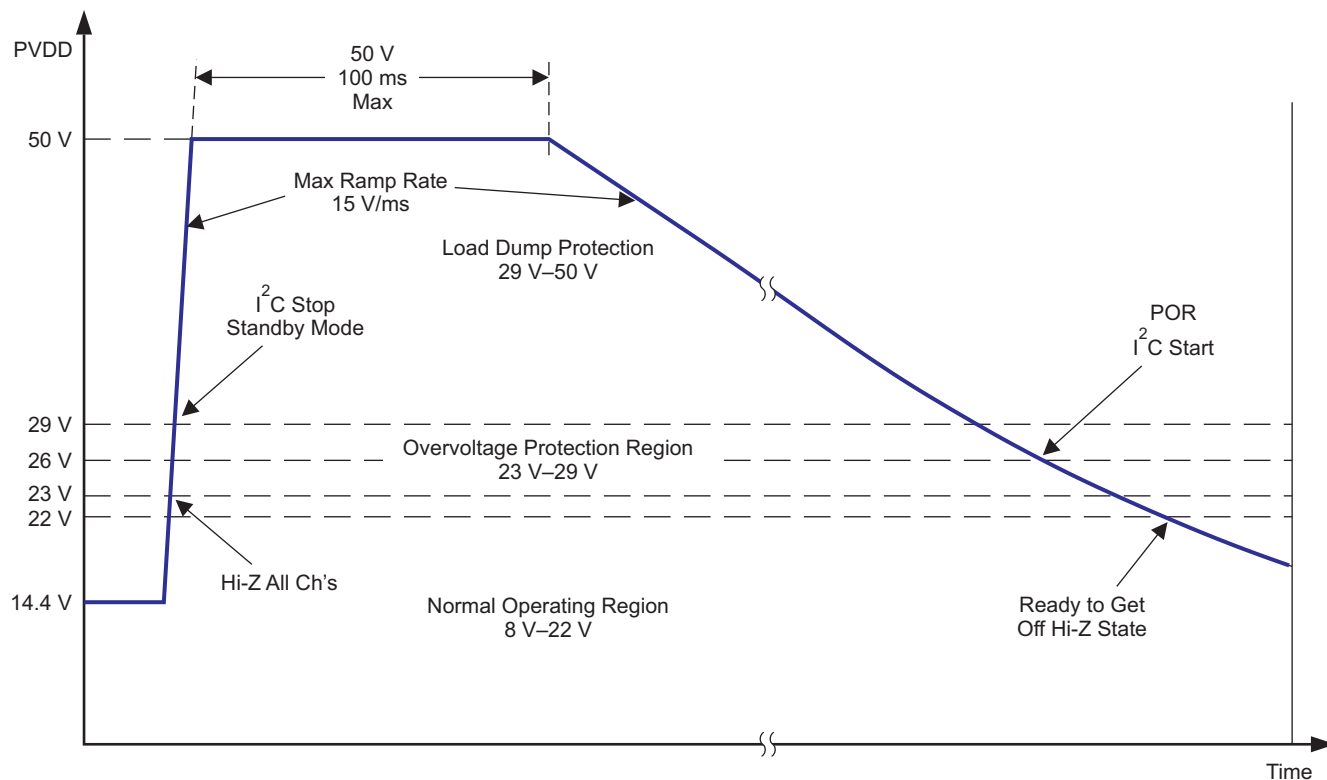

T0189-01

Figure 15. Voltage Operating Regions With Load Dump Transition Defined

Power Supply

The power for the device is most commonly provided by a car battery that can have a large voltage swing, 8 Vdc to 18 Vdc. PVDD is a filtered battery voltage, and it is the supply for the output FETs and the low-side FET gate driver. The high-side FET gate driver is supplied by a charge pump (CP) supply. The charge pump supplies the gate drive voltage for all four channels. The analog circuitry is powered by AVDD, which is provided by an internal linear regulator. A 0.1 μ F/10V external bypass capacitor is needed at the A_BYP pin for this supply. It is recommended that no external components except the bypass capacitor be attached to this pin. The digital circuitry is powered by DVDD, which is provided by an internal linear regulator. A 0.1 μ F/10V external bypass capacitor is needed at the D_BYP pin. It is recommended that no external components except the bypass capacitor be attached to this pin.

The TAS5414A and TAS5424A can withstand fortuitous open ground and power conditions. Fortuitous open ground usually occurs when a speaker wire is shorted to ground, allowing for a second ground path through the body diode in the output FETs. The uniqueness of the diagnostic capabilities allows the speakers and speaker wires to be debugged, eliminating the need to remove the amplifier to diagnose the problem.

I²C Serial Communication Bus

The TAS5414A and TAS5424A communicate with the system processor via the I²C serial communication bus. The TAS5414A and TAS5424A are I²C slave-only devices. The processor can poll the TAS5414A and the TAS5424A via I²C to determine the operating status of the device. All fault conditions and detections are reported via I²C. There are also numerous features and operating conditions that can be set via I²C.

The I²C bus allows control of the following configurations:

- Independent gain control of each channel. The gain can be set to 12 dB, 20 dB, 26 dB, and 32 dB.
- Select current limit (for 2- Ω and for 4- Ω loads). This allows optimal design of the filter inductor, and the use of smaller gauge speaker wires for 4- Ω applications.
- Select AM non-interference switching frequency

- Select the function of OTW_CLIP pin
- Enable or disable dc detect function with selectable threshold
- Place channel in Hi-Z (switching stopped) mode (mute)
- Select tweeter detect, set detect threshold and initiate function
- Initiate open/short load diagnostic
- Reset faults and return to normal switching operation from Hi-Z mode (unmute)

In addition to the standard SDA and SCL pins for the I²C bus, the TAS5414A and the TAS5424A include a single pin that allows up to four devices to work together in a system with no additional hardware required for communication or synchronization. The I2C_ADDR pin sets the device in master or slave mode and selects the I²C address for that device. Tie I2C_ADDR to GND for master, to 1.2 Vdc for slave 1, to 2.4 Vdc for slave 2, and to D_BYN for slave 3. The OSC_SYNC pin is used to synchronize the internal clock oscillators and thereby avoid beat frequencies. An external oscillator can also be applied to this pin for external control of the switching frequency.

Table 2. Table 7. I2C_ADDR Pin Connection

DESCRIPTION	I2C_ADDR PIN CONNECTION	I ² C ADDRESS
TAS5414A/5424 0 (OSC MASTER)	To GND pin	0xD8/D9
TAS5414A/5424 1 (OSC SLAVE1)	35% DVDD (resistive voltage divider between D_BYN pin and GND pin) ⁽¹⁾	0xDA/DB
TAS5414A/5424 2 (OSC SLAVE2)	65% DVDD (resistive voltage divider between D_BYN pin and GND pin) ⁽¹⁾	0xDC/DD
TAS5414A/5424 3 (OSC SLAVE3)	To D_BYN pin	0xDE/DF

(1) R_{I2C_ADDR} with 5% or better tolerance is recommended.

I²C Bus Protocol

The TAS5414A and TAS5424A have a bidirectional serial control interface that is compatible with the Inter IC (I²C) bus protocol and supports 100-kbps data transfer rates for random and sequential write and read operations. This is a slave-only device that does not support a multimaster bus environment or wait state insertion. The control interface is used to program the registers of the device and to read device status.

The I²C bus employs two signals, SDA (data) and SCL (clock), to communicate between integrated circuits in a system. Data is transferred on the bus serially, one bit at a time. The address and data are transferred in byte (8-bit) format with the most-significant bit (MSB) transferred first. In addition, each byte transferred on the bus is acknowledged by the receiving device with an acknowledge bit. Each transfer operation begins with the master device driving a start condition on the bus and ends with the master device driving a stop condition on the bus. The bus uses transitions on the data terminal (SDA) while the clock is HIGH to indicate a start and stop conditions. A HIGH-to-LOW transition on SDA indicates a start, and a LOW-to-HIGH transition indicates a stop. Normal data bit transitions must occur within the low time of the clock period. These conditions are shown in [Figure 16](#). The master generates the 7-bit slave address and the read/write (R/W) bit to open communication with another device and then wait for an acknowledge condition. The TAS5414A and TAS5424A hold SDA LOW during the acknowledge-clock period to indicate an acknowledgment. When this occurs, the master transmits the next byte of the sequence. Each device is addressed by a unique 7-bit slave address plus R/W bit (1 byte). All compatible devices share the same signals via a bidirectional bus using a wired-AND connection. An external pullup resistor must be used for the SDA and SCL signals to set the HIGH level for the bus. There is no limit on the number of bytes that can be transmitted between start and stop conditions. When the last word transfers, the master generates a stop condition to release the bus.

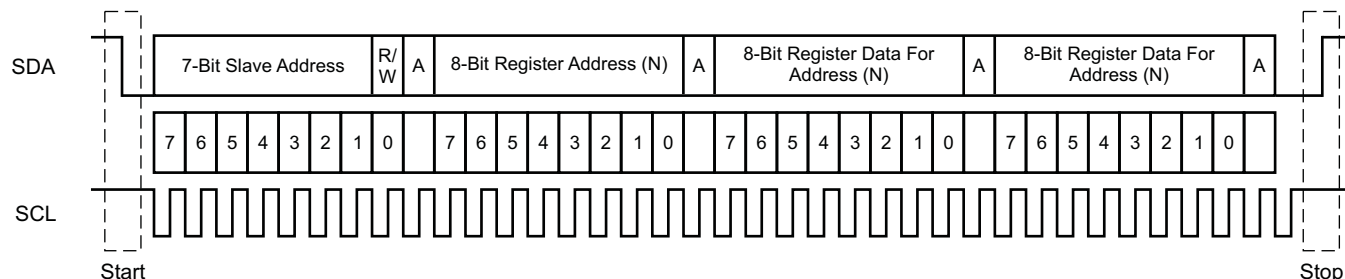

T0035-01

Figure 16. Typical I²C Sequence

Use the I2C_ADDR pin (pin 2) to program the device for one of four addresses. These four addresses are licensed I²C addresses and do not conflict with other licensed I²C audio devices. To communicate with the TAS5414A and the TAS5424A, the I²C master uses addresses shown in Figure 16. Read and write data can be transmitted using single-byte or multiple-byte data transfers.

Random Write

As shown in Figure 17, a single-byte data-write transfer begins with the master device transmitting a start condition followed by the I²C device address and the read/write bit. The read/write bit determines the direction of the data transfer. For a write data transfer, the read/write bit is a 0. After receiving the correct I²C device address and the read/write bit, the TAS5414A or TAS5424A device responds with an acknowledge bit. Next, the master transmits the address byte or bytes corresponding to the internal memory address being accessed. After receiving the address byte, the TAS5414A or TAS5424A again responds with an acknowledge bit. Next, the master device transmits the data byte to be written to the memory address being accessed. After receiving the data byte, the TAS5414A or TAS5424A again responds with an acknowledge bit. Finally, the master device transmits a stop condition to complete the single-byte data-write transfer.

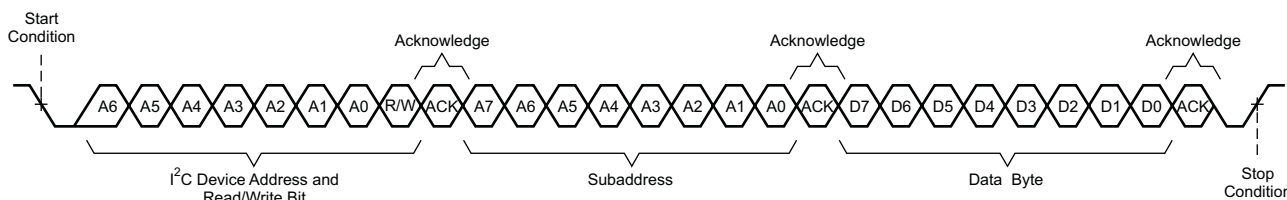

T0036-01

Figure 17. Random Write Transfer

Sequential Write

A sequential data-write transfer is identical to a single-byte data-write transfer except that multiple data bytes are transmitted by the master device to TAS5414A or TAS5424A as shown in Figure 17. After receiving each data byte, the TAS5414A or TAS5424A responds with an acknowledge bit and the I²C subaddress is automatically incremented by one.

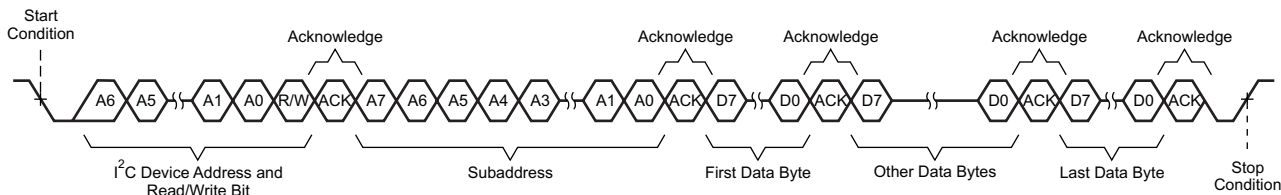

T0036-02

Figure 18. Sequential Write Transfer

Random Read

As shown in Figure 19, a single-byte data-read transfer begins with the master device transmitting a start condition followed by the I²C device address and the read/write bit. For the data-read transfer, both a write followed by a read are actually done. Initially, a write is done to transfer the address byte or bytes of the internal memory address to be read. As a result, the read/write bit is a 0. After receiving the address and the read/write bit, the TAS5414A or TAS5424A responds with an acknowledge bit. In addition, after sending the internal memory address byte or bytes, the master device transmits another start condition followed by the TAS5414A or TAS5424A address and the read/write bit again. This time the read/write bit is a 1, indicating a read transfer. After receiving the address and the read/write bit, the TAS5414A or TAS5424A again responds with an acknowledge bit. Next, the TAS5414A or TAS5424A transmits the data byte from the memory address being read. After receiving the data byte, the master device transmits a not-acknowledge followed by a stop condition to complete the single-byte data-read transfer.

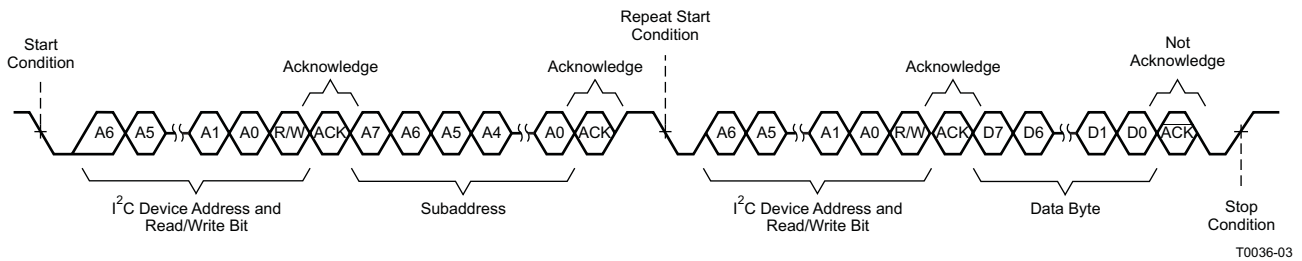

Figure 19. Random Read Transfer

Sequential Read

A sequential data-read transfer is identical to a single-byte data-read transfer except that multiple data bytes are transmitted by the TAS5414A or TAS5424A to the master device as shown in Figure 20. Except for the last data byte, the master device responds with an acknowledge bit after receiving each data byte and automatically increments the I²C subaddress by one. **Note:** The fault registers do not have sequential read capabilities.

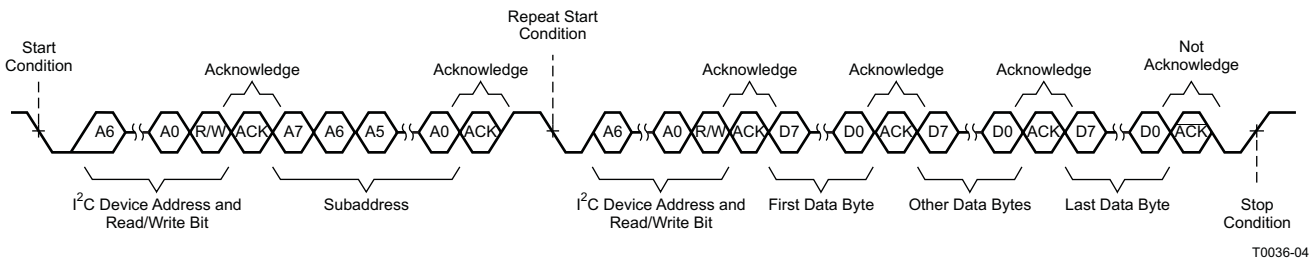

Figure 20. Sequential Read Transfer

Table 3. TAS5414A/5424 I²C Addresses

DESCRIPTION		FIXED ADDRESS					SELECTABLE WITH ADDRESS PIN		READ/WRITE BIT	I ² C ADDRESS
		MSB	6	5	4	3	2	1	LSB	
TAS5414A/5424 0 (OSC MASTER)	I ² C WRITE	1	1	0	1	1	0	0	0	0xD8
	I ² C READ	1	1	0	1	1	0	0	1	0xD9
TAS5414A/5424 1 (OSC SLAVE1)	I ² C WRITE	1	1	0	1	1	0	1	0	0xDA
	I ² C READ	1	1	0	1	1	0	1	1	0xDB
TAS5414A/5424 2 (OSC SLAVE2)	I ² C WRITE	1	1	0	1	1	1	0	0	0xDC
	I ² C READ	1	1	0	1	1	1	0	1	0xDD
TAS5414A/5424 3 (OSC SLAVE3)	I ² C WRITE	1	1	0	1	1	1	1	0	0xDE
	I ² C READ	1	1	0	1	1	1	1	1	0xDF

Table 4. I²C Address Register Definitions

ADDRESS	R/W	REGISTER DESCRIPTION
0x00	R	Latched fault register 1, global and channel fault
0x01	R	Latched fault register 2, dc offset and overcurrent detect
0x02	R	Latched diagnostic register 1, load diagnostics
0x03	R	Latched diagnostic register 2, load diagnostics
0x04	R	External status register 1, temperature and voltage detect
0x05	R	External status register 2, Hi-Z and low-low state
0x06	R	External status register 3, mute and play modes
0x07	R	External status register 4, load diagnostics
0x08	R/W	External control register 1, channel gain select
0x09	R/W	External control register 2, dc offset reduction and current-limit select
0x0A	R/W	External control register 3, switching frequency and clip pin select
0x0B	R/W	External control register 4, load diagnostic, master mode select
0x0C	R/W	External control register 5, output state control
0x0D	R/W	External control register 6, output state control
0x0E	R/W	External control register 7, dc detect level select
0x0F	R/W	External control register 8, dc detect level select

Table 5. Fault Register 1 (0x00) Protection

D7	D6	D5	D4	D3	D2	D1	D0	FUNCTION
0	0	0	0	0	0	0	0	No protection-created faults, default value
–	–	–	–	–	–	–	1	Overtemperature warning has occurred
–	–	–	–	–	–	1	–	DC offset has occurred in any channel
–	–	–	–	–	1	–	–	Overcurrent shutdown has occurred in any channel
–	–	–	–	1	–	–	–	Overtemperature shutdown has occurred
–	–	–	1	–	–	–	–	Charge pump undervoltage has occurred
–	–	1	–	–	–	–	–	AVDD, analog voltage, undervoltage has occurred
–	1	–	–	–	–	–	–	PVDD undervoltage has occurred
1	–	–	–	–	–	–	–	PVDD overvoltage has occurred

Table 6. Fault Register 2 (0x01) Protection

D7	D6	D5	D4	D3	D2	D1	D0	FUNCTION
0	0	0	0	0	0	0	0	No protection-created faults, default value
–	–	–	–	–	–	–	1	Overcurrent shutdown channel 1 has occurred
–	–	–	–	–	–	1	–	Overcurrent shutdown channel 2 has occurred

Table 6. Fault Register 2 (0x01) Protection (continued)

D7	D6	D5	D4	D3	D2	D1	D0	FUNCTION
–	–	–	–	–	1	–	–	Overcurrent shutdown channel 3 has occurred
–	–	–	–	1	–	–	–	Overcurrent shutdown channel 4 has occurred
–	–	–	1	–	–	–	–	DC offset channel 1 has occurred
–	–	1	–	–	–	–	–	DC offset channel 2 has occurred
–	1	–	–	–	–	–	–	DC offset channel 3 has occurred
1	–	–	–	–	–	–	–	DC offset channel 4 has occurred

Table 7. Diagnostic Register 1 (0x02) Load Diagnostics

D7	D6	D5	D4	D3	D2	D1	D0	FUNCTION
0	0	0	0	0	0	0	0	No load-diagnostic-created faults, default value
–	–	–	–	–	–	–	1	Output short to ground channel 1 has occurred
–	–	–	–	–	–	1	–	Output short to PVDD channel 1 has occurred
–	–	–	–	–	1	–	–	Shorted load channel 1 has occurred
–	–	–	–	1	–	–	–	Open load channel 1 has occurred
–	–	–	1	–	–	–	–	Output short to ground channel 2 has occurred
–	–	1	–	–	–	–	–	Output short to PVDD channel 2 has occurred
–	1	–	–	–	–	–	–	Shorted load channel 2 has occurred
1	–	–	–	–	–	–	–	Open load channel 2 has occurred

Table 8. Diagnostic Register 2 (0x03) Load Diagnostics

D7	D6	D5	D4	D3	D2	D1	D0	FUNCTION
0	0	0	0	0	0	0	0	No load-diagnostic-created faults, default value
–	–	–	–	–	–	–	1	Output short to ground channel 3 has occurred
–	–	–	–	–	–	1	–	Output short to PVDD channel 3 has occurred
–	–	–	–	–	1	–	–	Shorted load channel 3 has occurred
–	–	–	–	1	–	–	–	Open load channel 3 has occurred
–	–	–	1	–	–	–	–	Output short to ground channel 4 has occurred
–	–	1	–	–	–	–	–	Output short to PVDD channel 4 has occurred
–	1	–	–	–	–	–	–	Shorted load channel 4 has occurred
1	–	–	–	–	–	–	–	Open load channel 4 has occurred

Table 9. External Status Register 1 (0x04) Fault Detection

D7	D6	D5	D4	D3	D2	D1	D0	FUNCTION
0	0	0	0	0	0	0	0	No protection-created faults are present, default value
–	–	–	–	–	–	–	1	PVDD overvoltage fault is present
–	–	–	–	–	–	1	–	PVDD undervoltage fault is present
–	–	–	–	–	1	–	–	AVDD, analog voltage fault is present
–	–	–	–	1	–	–	–	Charge-pump voltage fault is present
–	–	–	1	–	–	–	–	Overtemperature shutdown is present
–	–	1	–	–	–	–	–	Overtemperature warning
–	1	1	–	–	–	–	–	Overtemperature warning level 1
1	0	1	–	–	–	–	–	Overtemperature warning level 2
1	1	1	–	–	–	–	–	Overtemperature warning level 3

Table 10. External Status Register 2 (0x05) Output State of Individual Channels

D7	D6	D5	D4	D3	D2	D1	D0	FUNCTION
0	0	0	0	1	1	1	1	Output is in Hi-Z mode, not in low-low mode ⁽¹⁾ , default value
–	–	–	–	–	–	–	0	Channel 1 Hi-Z mode (0 = not Hi-Z, 1 = Hi-Z)
–	–	–	–	–	–	0	–	Channel 2 Hi-Z mode (0 = not Hi-Z, 1 = Hi-Z)
–	–	–	–	–	0	–	–	Channel 3 Hi-Z mode (0 = not Hi-Z, 1 = Hi-Z)
–	–	–	–	0	–	–	–	Channel 4 Hi-Z mode (0 = not Hi-Z, 1 = Hi-Z)
–	–	–	1	–	–	–	–	Channel 1 low-low mode (0 = not low-low, 1 = low-low) ⁽¹⁾
–	–	1	–	–	–	–	–	Channel 2 low-low mode (0 = not low-low, 1 = low-low) ⁽¹⁾
–	1	–	–	–	–	–	–	Channel 3 low-low mode (0 = not low-low, 1 = low-low) ⁽¹⁾
1	–	–	–	–	–	–	–	Channel 4 low-low mode (0 = not low-low, 1 = low-low) ⁽¹⁾

(1) Low-low is defined as both outputs actively pulled to ground.

Table 11. External Status Register 3 (0x06) Play and Mute Modes

D7	D6	D5	D4	D3	D2	D1	D0	FUNCTION
0	0	0	0	0	0	0	0	Mute mode is disabled, play mode disabled, default value, (Hi-Z mode)
–	–	–	–	–	–	–	1	Channel 1 play mode is enabled
–	–	–	–	–	–	1	–	Channel 2 play mode is enabled
–	–	–	–	–	1	–	–	Channel 3 play mode is enabled
–	–	–	–	1	–	–	–	Channel 4 play mode is enabled
–	–	–	1	–	–	–	–	Channel 1 mute mode is enabled
–	–	1	–	–	–	–	–	Channel 2 mute mode is enabled
–	1	–	–	–	–	–	–	Channel 3 mute mode is enabled
1	–	–	–	–	–	–	–	Channel 4 mute mode is enabled

Table 12. External Status Register 4 (0x07) Load Diagnostics

D7	D6	D5	D4	D3	D2	D1	D0	FUNCTION
0	0	0	0	0	0	0	0	No channels are set in load diagnostics mode, default value
–	–	–	–	–	–	–	1	Channel 1 is in load diagnostics mode
–	–	–	–	–	–	1	–	Channel 2 is in load diagnostics mode
–	–	–	–	–	1	–	–	Channel 3 is in load diagnostics mode
–	–	–	–	1	–	–	–	Channel 4 is in load diagnostics mode
X	X	X	X	–	–	–	–	Reserved

Table 13. External Control Register 1 (0x08) Gain Select

D7	D6	D5	D4	D3	D2	D1	D0	FUNCTION
1	0	1	0	1	0	1	0	Set gain for all channels to 26 dB, default value
–	–	–	–	–	–	0	0	Set channel 1 gain to 12 dB
–	–	–	–	–	–	0	1	Set channel 1 gain to 20 dB
–	–	–	–	–	–	1	1	Set channel 1 gain to 32 dB
–	–	–	–	0	0	–	–	Set channel 2 gain to 12 dB
–	–	–	–	0	1	–	–	Set channel 2 gain to 20 dB
–	–	–	–	1	1	–	–	Set channel 2 gain to 32 dB
–	–	0	0	–	–	–	–	Set channel 3 gain to 12 dB
–	–	0	1	–	–	–	–	Set channel 3 gain to 20 dB
–	–	1	1	–	–	–	–	Set channel 3 gain to 32 dB
0	0	–	–	–	–	–	–	Set channel 4 gain to 12 dB
0	1	–	–	–	–	–	–	Set channel 4 gain to 20 dB
1	1	–	–	–	–	–	–	Set channel 4 gain to 32 dB

Table 14. External Control Register 2 (0x09) DC Offset Reduction and Current Limit

D7	D6	D5	D4	D3	D2	D1	D0	FUNCTION
0	0	0	0	0	0	0	0	Enable dc offset reduction, set current limit to level 1
–	–	–	–	–	–	–	1	Disable channel 1 dc offset reduction
–	–	–	–	–	–	1	–	Disable channel 2 dc offset reduction
–	–	–	–	–	1	–	–	Disable channel 3 dc offset reduction
–	–	–	–	1	–	–	–	Disable channel 4 dc offset reduction
–	–	–	1	–	–	–	–	Set channel 1 current limit (0 = level 1, 1 = level 2)
–	–	1	–	–	–	–	–	Set channel 2 current limit (0 = level 1, 1 = level 2)
–	1	–	–	–	–	–	–	Set channel 3 current limit (0 = level 1, 1 = level 2)
1	–	–	–	–	–	–	–	Set channel 4 current limit (0 = level 1, 1 = level 2)

Table 15. External Control Register 3 (0x0A) Switching Frequency Select and Clip_OTW Configuration

D7	D6	D5	D4	D3	D2	D1	D0	FUNCTION
0	0	0	0	1	1	0	1	Set $f_S = 417$ kHz, configure clip and OTW, 45° phase, disable hard stop
–	–	–	–	–	–	0	0	Set $f_S = 500$ kHz
–	–	–	–	–	–	1	0	Set $f_S = 357$ kHz
–	–	–	–	–	–	1	1	Invalid frequency selection (do not set)
–	–	–	–	0	0	–	–	Configure $\overline{\text{CLIP_OTW}}$ pin for tweeter detect only
–	–	–	–	0	1	–	–	Configure $\overline{\text{CLIP_OTW}}$ pin for clip detect only
–	–	–	–	1	0	–	–	Configure $\overline{\text{CLIP_OTW}}$ pin for overtemperature warning only
–	–	–	1	–	–	–	–	Enable hard-stop mode
–	–	1	–	–	–	–	–	Set f_S to a 180° phase difference between adjacent channels
X	X	–	–	–	–	–	–	Reserved

Table 16. External Control Register 4 (0x0B) Load Diagnostics and Master/Slave Control

D7	D6	D5	D4	D3	D2	D1	D0	FUNCTION
0	1	0	0	0	0	0	0	Disable load diagnostics and dc detect SD, master mode
–	–	–	–	–	–	–	1	Enable channel 1, load diagnostics
–	–	–	–	–	–	1	–	Enable channel 2, load diagnostics
–	–	–	–	–	1	–	–	Enable channel 3, load diagnostics
–	–	–	–	1	–	–	–	Enable channel 4, load diagnostics
–	–	–	1	–	–	–	–	Enable dc detect shutdown on all channels
–	–	1	–	–	–	–	–	Enable tweeter-detect mode
–	0	–	–	–	–	–	–	Enable slave mode (external oscillator must be provided)
X	–	–	–	–	–	–	–	Reserved

Table 17. External Control Register 5 (0x0C) Output Control

D7	D6	D5	D4	D3	D2	D1	D0	FUNCTION
0	0	0	1	1	1	1	1	All channels, Hi-Z, mute, reset disabled
–	–	–	–	–	–	–	0	Set channel 1 to mute mode, non-Hi-Z
–	–	–	–	–	–	0	–	Set channel 2 to mute mode, non-Hi-Z
–	–	–	–	–	0	–	–	Set channel 3 to mute mode, non-Hi-Z
–	–	–	–	0	–	–	–	Set channel 4 to mute mode, non-Hi-Z
–	–	–	0	–	–	–	–	Set non-Hi-Z channels to play mode, (unmute)
–	1	1	–	–	–	–	–	Reserved
1	–	–	–	–	–	–	–	Reset device (I^2C does not respond with an ACK)

Table 18. External Control Register 6 (0x0D) Output Control

D7	D6	D5	D4	D3	D2	D1	D0	FUNCTION
0	0	0	0	0	0	0	0	Low-low state disabled all channels
–	–	–	–	–	–	–	1	Set channel 1 to low-low state
–	–	–	–	–	–	1	–	Set channel 2 to low-low state
–	–	–	–	–	1	–	–	Set channel 3 to low-low state
–	–	–	–	1	–	–	–	Set channel 4 to low-low state
X	X	X	X	–	–	–	–	Reserved

Table 19. External Control Register 7 (0x0E) Positive DC Detect Threshold Selection

D7	D6	D5	D4	D3	D2	D1	D0	FUNCTION
1	0	0	0	1	1	1	0	Default positive dc detect value
0	1	1	0	0	1	0	1	Minimum positive dc detect value
X	X	X	X	X	X	X	X	See Figure 11 to set positive dc detect value
1	1	0	0	1	0	1	1	Maximum positive dc detect value

Table 20. External Control Register 8 (0x0F) Negative DC Detect Threshold Selection

D7	D6	D5	D4	D3	D2	D1	D0	FUNCTION
0	0	1	1	1	1	0	1	Default negative dc detect value
0	1	1	0	0	1	0	1	Minimum negative dc detect value
X	X	X	X	X	X	X	X	See Figure 12 to set negative dc detect value
0	0	0	0	0	0	0	0	Maximum negative dc detect value

Hardware Control Pins

The TAS5414A and TAS5424A incorporate four discrete hardware pins for real-time control and indication of device status.

FAULT pin: This active-low, open-drain output pin indicates the presence of a fault condition that requires the TAS5414A and TAS5424A to go automatically into the Hi-Z mode or standby mode. When this pin is asserted high, the device has acted to protect itself and the system from potential damage. The exact nature of the fault can be read via I²C with the exception of faults that are the result of PVDD voltage excursions above 25 Vdc or below 6 Vdc. In these instances, the device goes into standby mode and the I²C bus is no longer operational. However, the fault is still indicated due to the fact that the FAULT pin is open-drain and active-high.

CLIP_OTW pin: The function of this active-low pin is configured by the user to indicate one of the following conditions: overtemperature warning, the detection of clipping, or the logical OR of both of these conditions. The configuration is selected via I²C. During tweeter detect diagnostics, this pin also is asserted when a tweeter is present.

MUTE pin: This active-low pin is used for hardware control of the mute/unmute function for all four channels. Capacitor C_{MUTE} is used to control the time constant for the gain ramp needed to produce a pop- and click-free mute function. For pop- and click-free operation, the mute function should be implemented through I²C commands. The use of a hard mute with an external transistor does not ensure pop- and click-free operation, and is not recommended unless an *emergency hard mute* function is required in case of a loss of I²C control. For proper pop- and click-free operation the minimum recommended value of C_{MUTE} is 330 nF.

STANDBY pin: When this active-low pin is asserted, the device goes into a complete shutdown, and current draw is limited to 2 μ A, typical. This is pin typically asserted when the car ignition is in the off position. It can also be used to shut down the device rapidly when certain operating conditions are violated. All I²C register content is lost when this pin is asserted. The I²C bus goes into the high-impedance state when the STANDBY pin is asserted.

EMI Considerations

Automotive level EMI performance depends on both careful integrated circuit design and good system level design. Controlling sources of electromagnetic interference (EMI) was a major consideration in all aspects of the TAS5414A and TAS5424A design.

The TAS5414A and TAS5424A have minimal parasitic inductances due to the short leads on the PSOP3 package. This dramatically reduces the EMI that results from current passing from the die to the system PCB. Each channel of the TAS5414A and TAS5424A also operates at a different phase. The phase between channels is I²C selectable to either 45° or 180°, to reduce EMI caused by high-current switching. The TAS5414A and TAS5424A incorporate patent-pending circuitry that optimizes output transitions that cause EMI.

AM Radio EMI Reduction

To reduce interference in the AM radio band, the TAS5414A and TAS5424A have the ability to change the switching frequency via I²C commands. The recommended frequencies are listed in Table 21. The fundamental frequency and its second harmonic straddle the AM radio band listed. This eliminates the tones that can be present due to the switching frequency being demodulated by the AM radio. To function properly, AM avoidance requires the use of a 20-kΩ, 1% tolerance Rext resistor.

Table 21. Recommended Switching Frequencies for AM Mode Operation

US		EUROPEAN	
AM FREQUENCY (kHz)	SWITCHING FREQUENCY (kHz)	AM FREQUENCY (kHz)	SWITCHING FREQUENCY (kHz)
		522-540	417
540-917	500	540-914	500
917-1125	417	914-1122	417
1125-1375	500	1122-1373	500
1375-1547	417	1373-1548	417
1547-1700	357	1548-1701	357

Operating States

The operating regions, or states, of the TAS5414A and TAS5424A are depicted in the following tables.

Table 22. Operating States and Supplies

STATE NAME	OUTPUT FETS	CHARGE PUMP	OSCILLATOR	I ² C	AVDD and DVDD
STANDBY	Hi-Z, floating	Stopped	Stopped	Stopped	OFF
Hi-Z	Hi-Z, weak pulldown	Active	Active	Active	ON
Mute	Switching at 50%	Active	Active	Active	ON
Normal operation	Switching with audio	Active	Active	Active	ON

Table 23. Global Faults and Actions

FAULT/ EVENT	FAULT/EVENT CATEGORY	MONITORING MODES	REPORTING METHOD	ACTION TYPE	ACTION RESULT	LATCHED/ SELF-CLEARING
POR	Voltage fault	All	$\overline{\text{FAULT}}$ pin	Hard mute (no ramp)	Standby	Self-clearing
UV		Hi-Z, mute, normal	I ² C + $\overline{\text{FAULT}}$ pin		Hi-Z	Latched
CP UV					Hi-Z	
OV		Hi-Z				
Load dump		All	$\overline{\text{FAULT}}$ pin		Standby	Self-clearing
OTW	Thermal warning	Hi-Z, mute, normal	I ² C + $\overline{\text{CLIP_OTW}}$ pin	None	None	Self-clearing
OTSD	Thermal fault	Hi-Z, mute, normal	I ² C + $\overline{\text{FAULT}}$ pin	Hard mute	Standby	Latched

Table 24. Channel Faults and Actions

FAULT/ EVENT	FAULT/EVENT CATEGORY	MONITORING MODES	REPORTING METHOD	ACTION TYPE	ACTION RESULT	LATCHED/ SELF-CLEARING
Open/short diagnostic	Diagnostic	Hi-Z (I ² C activated)	I ² C	None	None	Latched
Clipping online	Warning	Normal	$\overline{\text{CLIP_OTW}}$ pin	None	None	Self-clearing
CBC load current limit	Online protection	Mute, normal	$\overline{\text{CLIP_OTW}}$ pin	Current limit	Start OC timer	Self-clearing
OC fault	Output channel fault	Mute, normal	I ² C + $\overline{\text{FAULT}}$ pin	Hard mute	Hi-Z	Latched
DC detect		Normal	I ² C + $\overline{\text{FAULT}}$ pin	Hard mute	Hi-Z	Latched

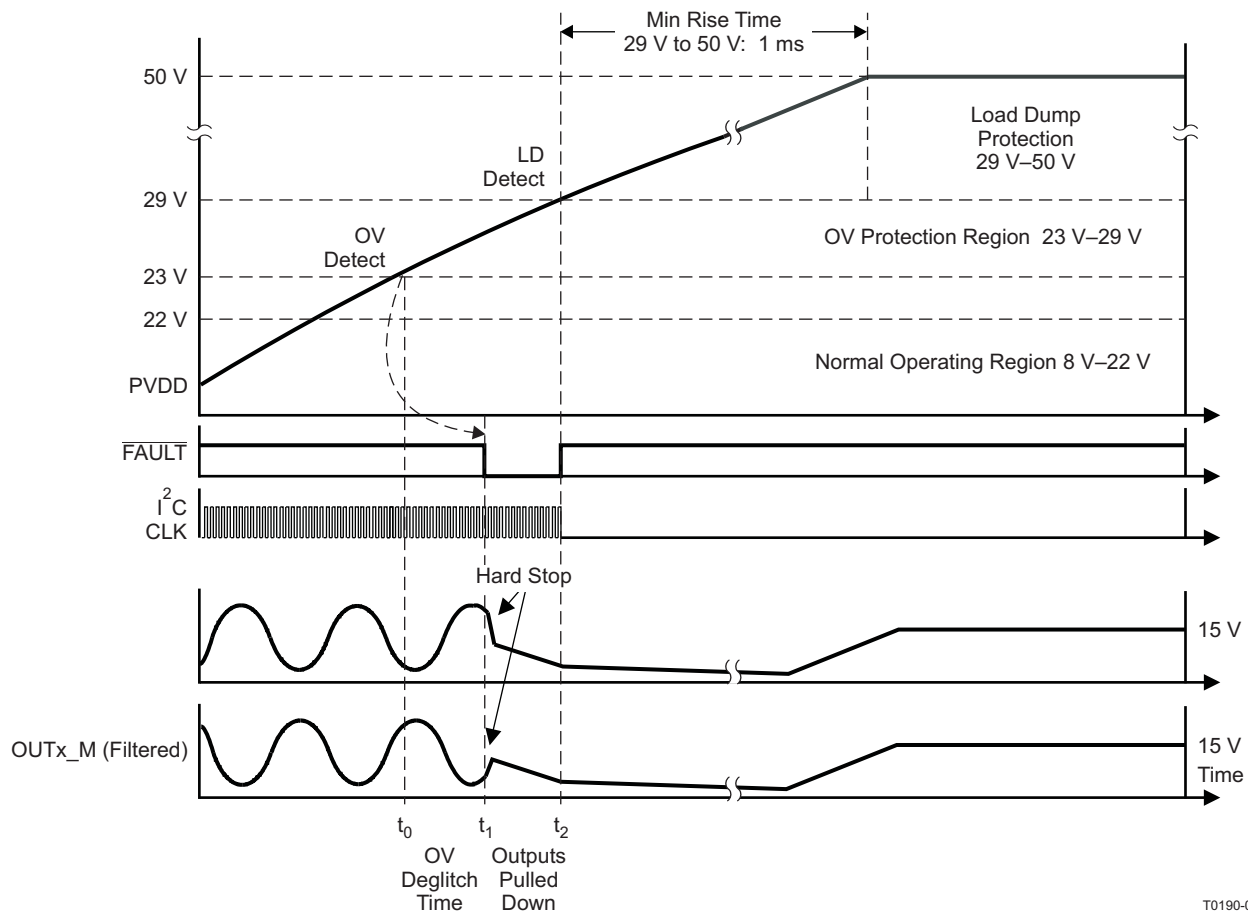

Figure 21. Sequence of Events for Supply Transition Out of Normal Operating Region

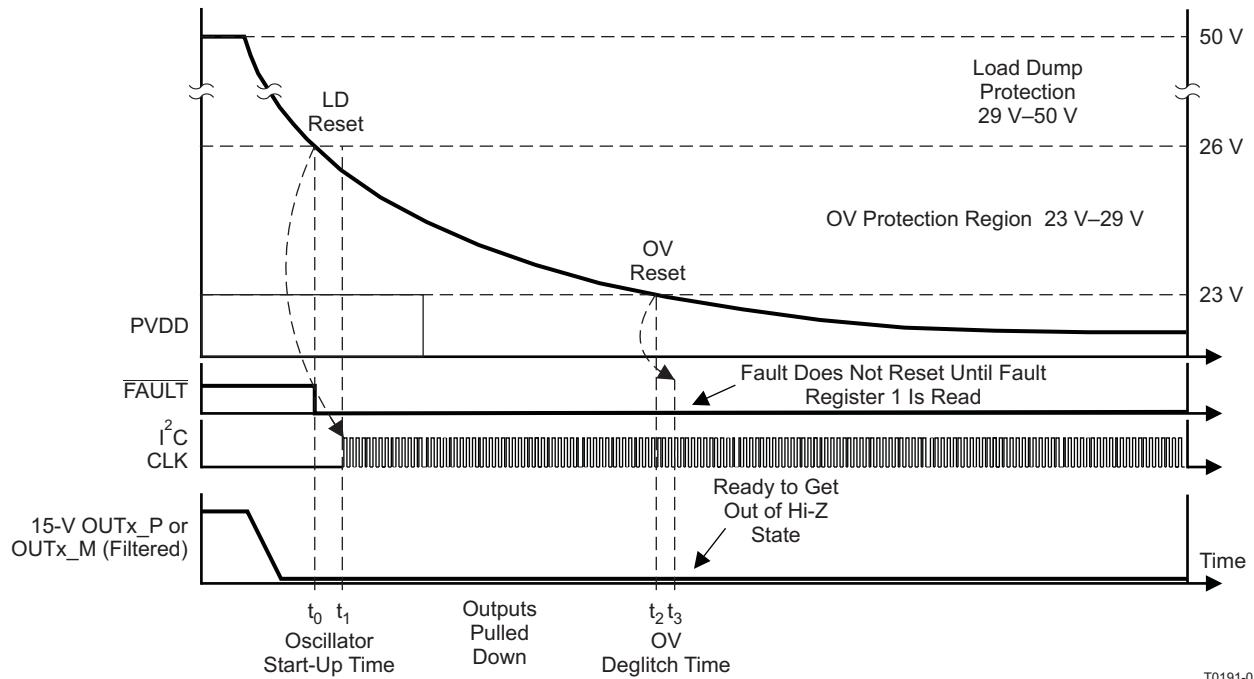
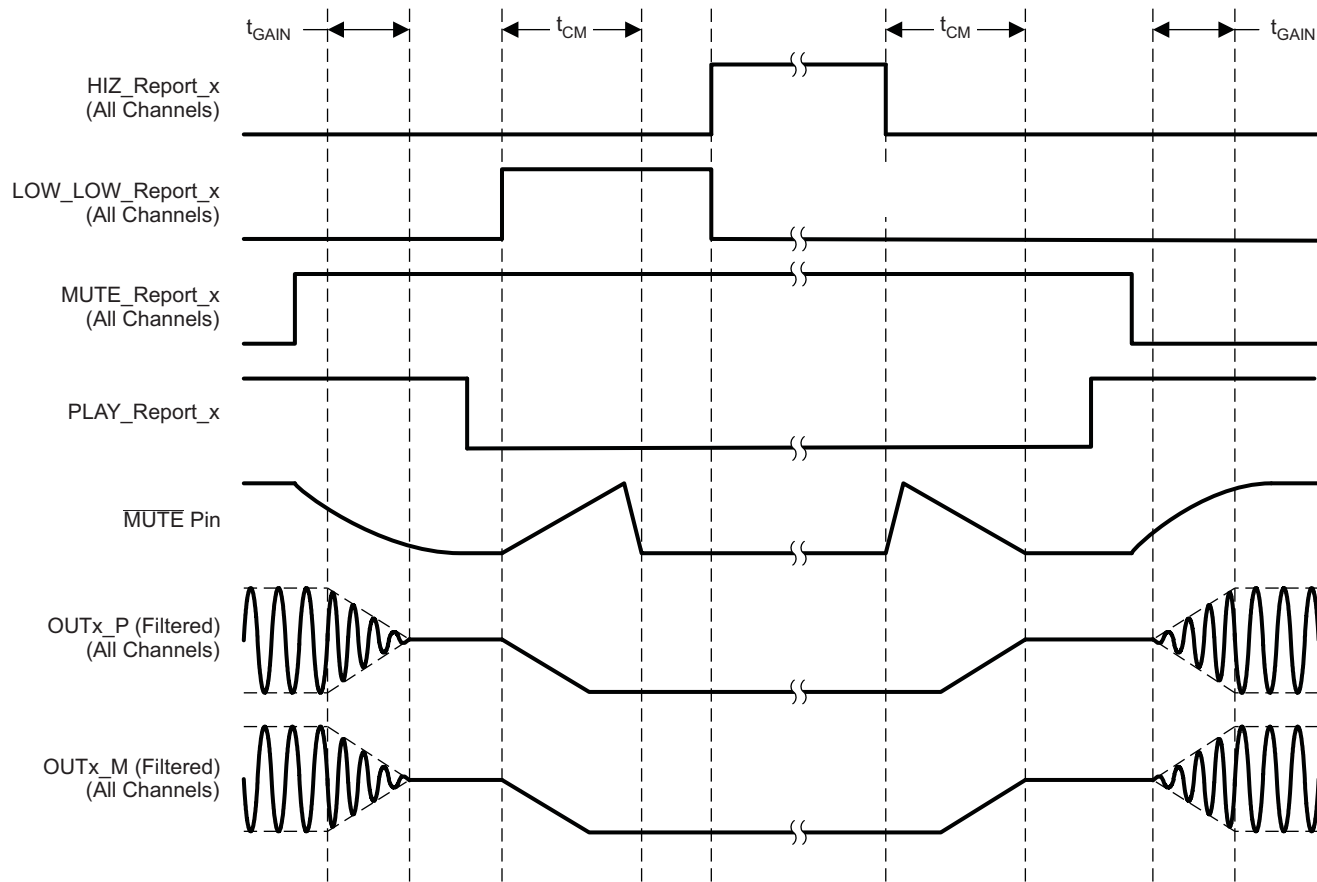

Figure 22. Sequence of Events for Supply Transition Back Into Normal Operating Region

Power Shutdown and Restart Sequence Control

The gain ramp of the filtered output signal and the updating of the I²C registers correspond to the MUTE pin voltage during the ramping process. For the decreasing gain ramp (when transitioning from Play to Mute mode), the actual decrease in output gain begins when the MUTE pin voltage is approximately 2/3 of the A_BYP voltage, and the ramp itself completes when the MUTE pin voltage is approximately 1/3 of A_BYP. However, the I²C register indicating that Mute mode has been entered does not update externally until the MUTE pin voltage is approximately 1/10 of the A_BYP voltage. Conversely, for the increasing ramp process (when transitioning from Mute to Play), the actual increase in output gain begins when the MUTE pin voltage is approximately 1/3 of the A_BYP voltage and the gain increase completes when the MUTE pin voltage is approximately 2/3 of A_BYP. The I²C register indicating Play mode has been entered updates when the MUTE pin voltage is approximately 9/10 of the A_BYP voltage. For both gain ramps, the change in MUTE pin voltage begins when the I²C command to change operating modes is received by the device. The length of time that the MUTE pin takes to complete its ramp is dictated by the value of the external capacitor on the MUTE pin.



T0192-02

Figure 23. Click- and Pop-Free Shutdown and Restart Sequence Timing Diagram With Four Channels Sharing the Mute Pin

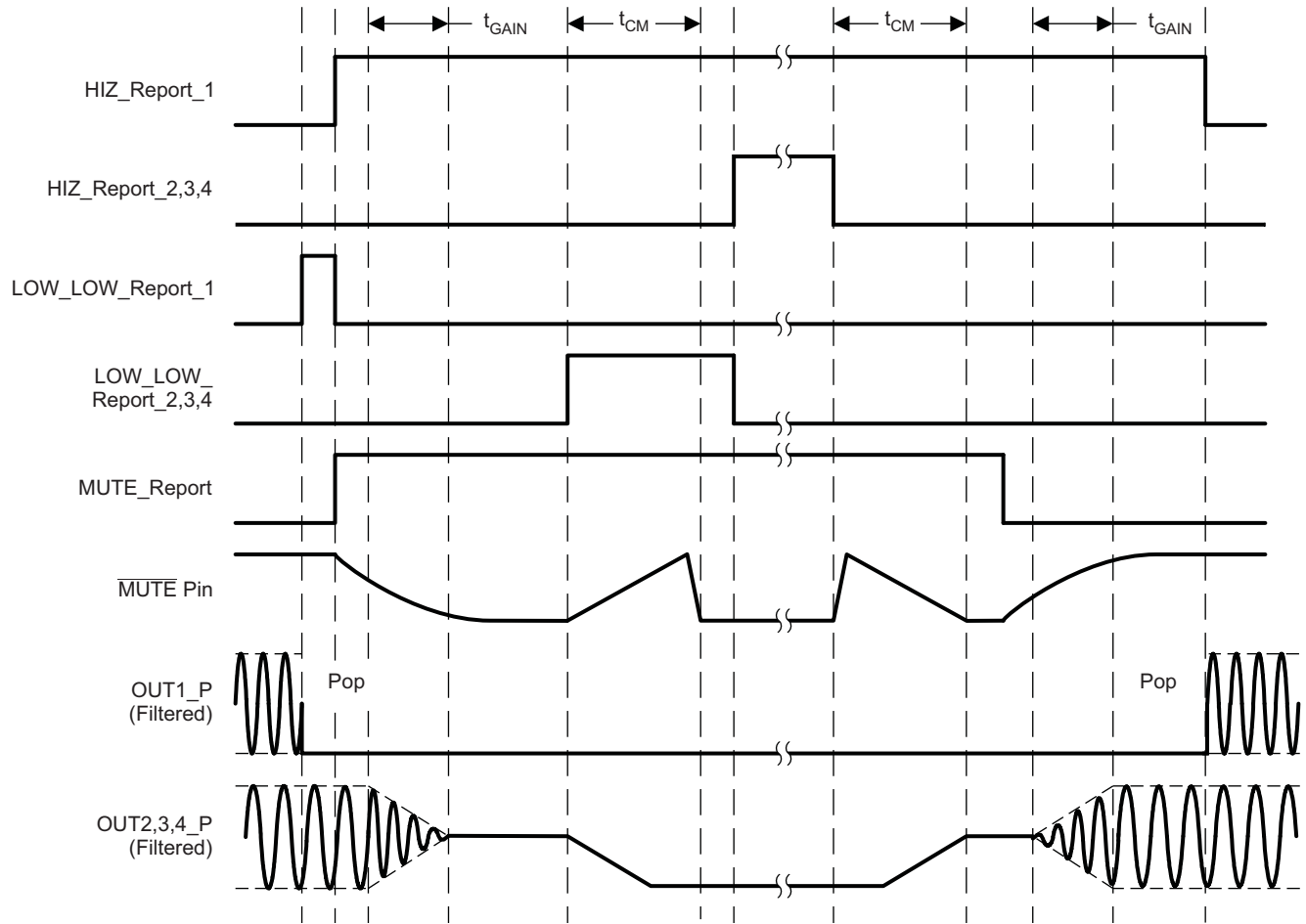

T0193-02

Figure 24. Individual Channel Shutdown and Restart Sequence Timing Diagram

Latched Fault Shutdown and Restart Sequence Control

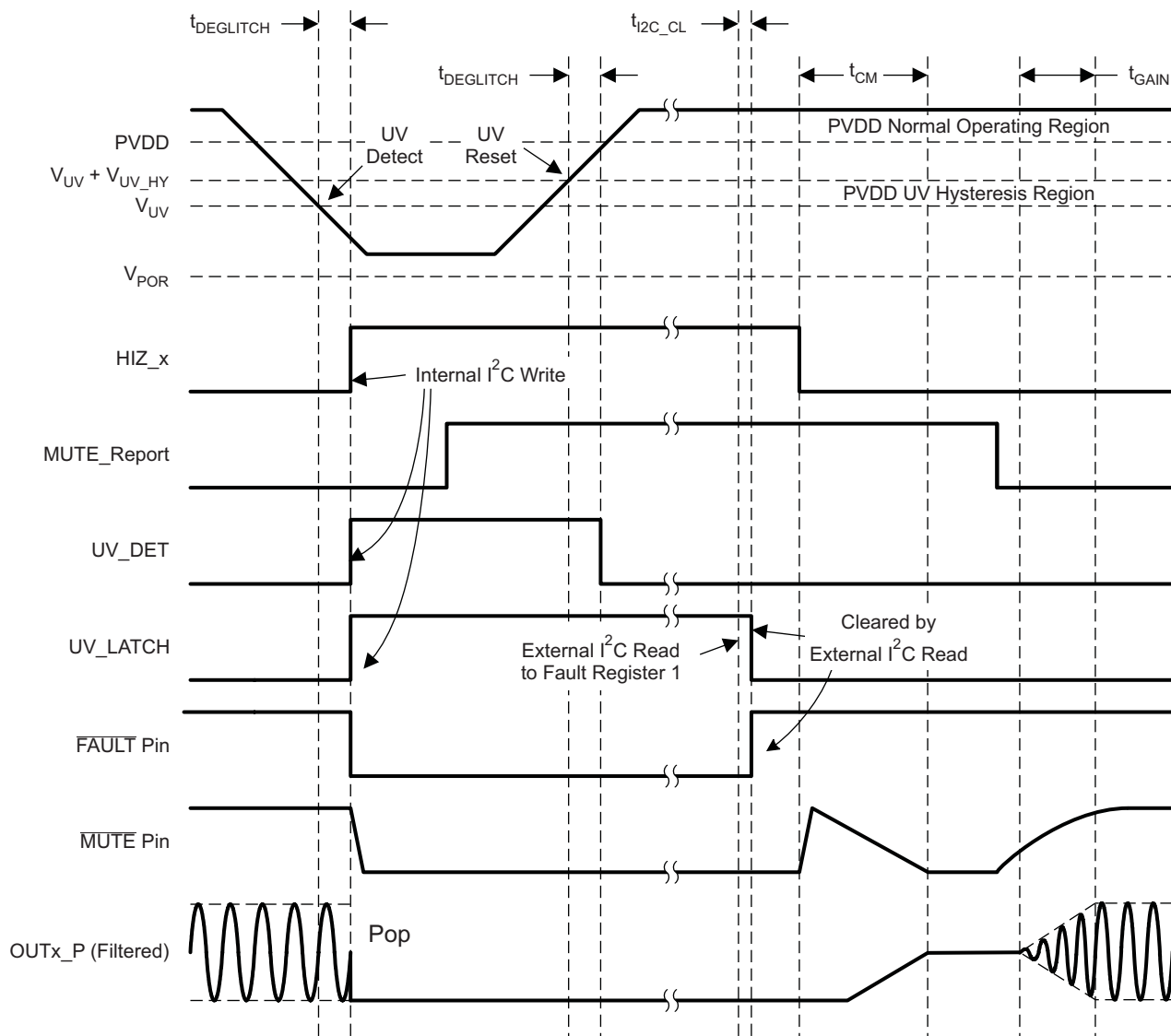

T0194-02

Figure 25. Latched Global Fault Shutdown and Restart Timing Diagram (UV Shutdown and Recovery)

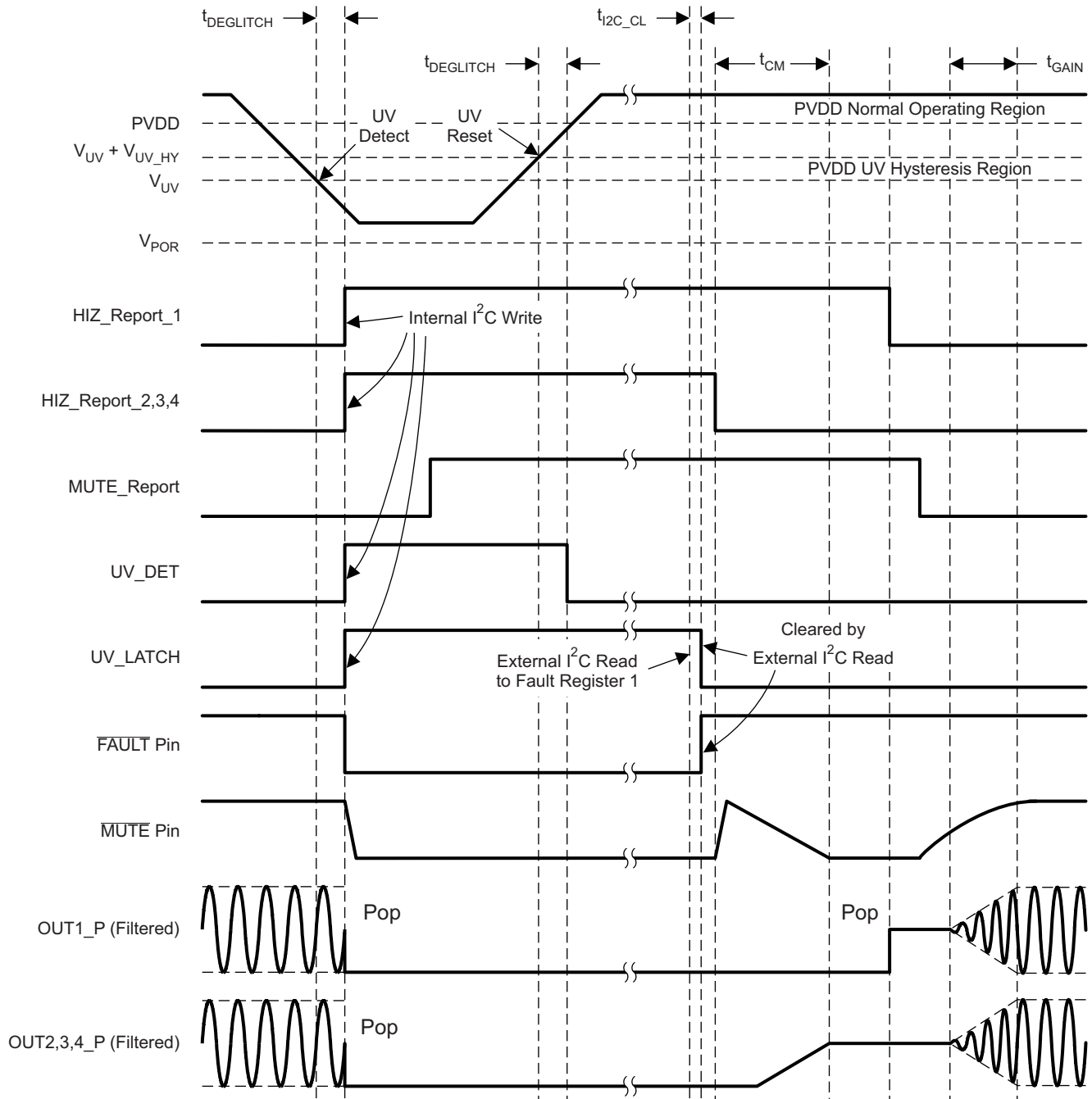
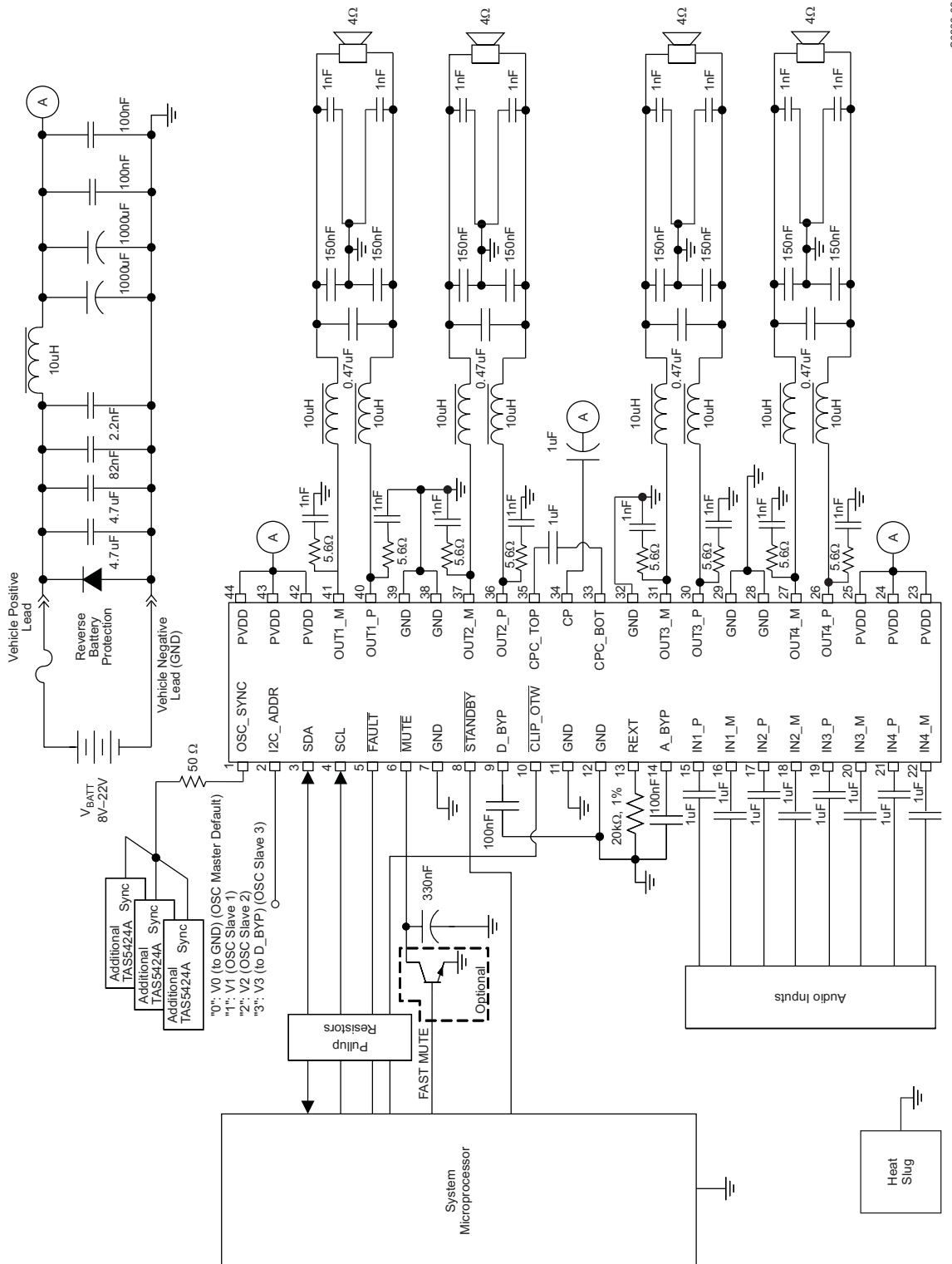

Figure 26. Latched Global Fault Shutdown and Individual Channel Restart Timing Diagram (UV Shutdown and Recovery)



S0236-02

Figure 28. TAS5424A Typical Application Schematic

Parallel Operation (PBTL)

The TAS5414A and TAS5424A can be used to drive four 4-Ω loads, two 2-Ω loads, or even one 1-Ω load by paralleling BTL channels on the load side of the LC output filter. For parallel operation, identical I²C settings are required for any two paralleled channels (especially gain and current-limit settings) in order to have reliable system performance and evenly dissipated power on multiple channels. Having identical gain and current-limit settings can also prevent energy feeding back from one channel to the other. For smooth power up, power down, and mute operation, the same control commands (such as mute, play, Hi-Z, etc.) should be sent to the paralleled channels at the same time. Load diagnostic is also supported for parallel connection. Paralleling on the TAS5414A and TAS5424A side of the LC output filter is not supported, and can result in device failure.

Input Filter Design

For the TAS5424A device, the input filter for a single channel's P and M inputs should be identical. For the TAS5414A the IN_M pin should have an impedance to GND that is equivalent to the parallel combination of the input impedances of all IN_P channels combined, including any source impedance from the previous stage in the system design. For example, if each of the 4 IN_P channels have a 1μF DC blocking capacitor, 1kΩ of series resistance due to an input RC filter, and 1kΩ of source resistance from the DAC supplying the audio signal, the IN_M channel should have a 4μF capacitor in series with a 500Ω resistor to GND (4 x 1μF in parallel = 4μF; 4 x 2kΩ in parallel = 500Ω).

Demodulation Filter Design

The TAS5414A and TAS5424A amplifier outputs are driven by high-current LDMOS transistors in an H-bridge configuration. These transistors are either off or fully on. The result is a square-wave output signal with a duty cycle that is proportional to the amplitude of the audio signal. It is recommended that a second-order LC filter be used to recover the audio signal. The main purpose of the demodulation filter is to attenuate the high-frequency components of the output signals that are out of the audio band. Design of the demodulation filter significantly affects the audio performance of the power amplifier. Therefore, to meet the device THD+N specification, the selection of the inductors used in the output filter should be carefully considered. The rule is that the inductance should remain stable within the range of peak current seen at maximum output power and deliver approximately 5 μH of inductance at 16 A. If this rule is observed, the TAS5414A and TAS5424A should not have distortion issues due to the output inductors. Another parameter to be considered is the idle-current loss in the inductor. This can be measured or specified as inductor dissipation (D). The target specification for dissipation is less than 0.05. If the dissipation factor is above this value, idle current increases. In general, 10-μH inductors suffice for most applications. The frequency response of the amplifier is slightly altered by the change in output load resistance; however, unless tight control of frequency response is necessary (better than 0.5 dB), it is not necessary to deviate from 10 μH.

Line Driver Applications

In many automotive audio applications the end user would like to use the same head unit to drive either a speaker (with several Ohms of impedance) or an external amplifier (with several kΩ of impedance). The TAS5414A and the TAS5424A are capable of supporting both applications. However, the output filter must be sized appropriately to handle the expected output load in either case (i.e. different output filter values need to be populated to handle the two different cases). If the user would like to use the same output filter for both applications additional hardware measures such as a Zobel filter are needed to ensure output stability for both loading conditions. Please refer to the TAS54x4A hardware application note for additional details.

Thermal Information

The thermally augmented package provided with the TAS5414A and TAS5424A is designed to interface directly to heat sinks using a thermal interface compound (for example, Arctic Silver, Ceramique thermal compound.) The heat sink then absorbs heat from the ICs and couples it to the local air. If louvers or fans are supplied, this process can reach equilibrium and heat can be continually removed from the ICs. Because of the efficiency of the TAS5414A and TAS5424A, heat sinks can be smaller than those required for linear amplifiers of equivalent performance.

R_{θJA} is a system thermal resistance from junction to ambient air. As such, it is a system parameter with the following components:

- R_{θJC} (the thermal resistance from junction to case, or in this case the heat slug)

- Thermal grease thermal resistance
- Heat sink thermal resistance

The thermal grease thermal resistance can be calculated from the exposed heat slug area and the thermal grease manufacturer's area thermal resistance (expressed in °C-in²/W or °C-mm²/W). The area thermal resistance of the example thermal grease with a 0.001-inch (0.0254-mm) thick layer is about 0.007°C-in²/W (4.52°C-mm²/W). The approximate exposed heat slug size is as follows:

TAS5424A, 44-pin PSOP3	0.124 in ² (80 mm ²)
TAS5414A, 36-pin PSOP3	0.124 in ² (80 mm ²)
TAS5414A, TAS5424A, 64-pin QFP.....	0.099 in ² (64 mm ²)

Dividing the example thermal grease area resistance by the area of the heat slug gives the actual resistance through the thermal grease for both parts:

TAS5424A, 44-pin PSOP3	0.06°C/W
TAS5414A, 36-pin PSOP3	0.06°C/W
TAS5414A, TAS5424A, 64-pin QFP.....	0.07°C/W

The thermal resistance of thermal pads is generally considerably higher than a thin thermal grease layer. Thermal tape has an even higher thermal resistance and should not be used at all. Heat sink thermal resistance generally is predicted by the heat sink vendor, modeled using a continuous flow dynamics (CFD) model, or measured.

Thus, for a single monaural channel in the IC, the system $R_{\theta JA} = R_{\theta JC} + \text{thermal grease resistance} + \text{heat sink resistance}$.

The following table indicates modeled parameters for one TAS5414A or TAS5424A IC on a heat sink. The junction temperature is set at 115°C in both cases while delivering 20 W_{rms} per channel into 4-Ω loads with no clipping. It is assumed that the thermal grease is about 0.001 inches (0.0254 mm) thick.

Device	TAS5414A, 36-Pin PSOP3
Ambient temperature	25°C
Power to load	20 W × 4
Power dissipation	1.90 W × 4
ΔT inside package	7.6°C
ΔT through thermal grease	0.46°C
Required heatsink thermal resistance	10.78°C/W
Junction temperature	115°C
System $R_{\theta JA}$	11.85°C/W
$R_{\theta JA} \times \text{power dissipation}$	90°C

Electrical Connection of Heat Slug and Heat Sink

Any heat sink that is connected to the heat slug of the TAS5414A or TAS5424A should be connected to GND or left floating. The heat slug should never be connected to any electrical node other than GND.

REVISION HISTORY

Changes from Revision A (February 2008) to Revision B	Page
• Changed all instances of SGND and PGND to GND on all pinout diagrams	4
• Deleted TAS5424A from PHD package in the Terminal Functions table	6
• Changed all PGND and SGND pins to GND	6
• Changed upper end of V_{STANDBY} voltage range to 5.5 V in absolute Maximum Ratings	7
• Changed value for $V_{\text{AIN_AC_MAX_5414}}$ and $V_{\text{AIN_AC_MAX_5424}}$ in Absolute Maximum Ratings	7
• Deleted V_{PGND} , V_{SGND} , and T_{SOLDER} rows from Absolute Maximum Ratings. Changed all occurrences in document of PGND and SGND to GND	7
• Deleted $V_{\text{IN_CM}}$ row from Electrical Characteristics table	9
• Added power level to Test Condition of gain measurement in Electrical Characteristics	9
• Changed text of Tweeter Detection paragraph and added a note	18
• Added caution regarding PHD package thermal weakness	19
• Changed maximum ramp rate to 15 V/ms in Figure 15	20
• Unified ground names and symbols, and added 50- Ω series resistor for OSC_SYNC line, on TAS5414A application schematic	36
• Unified ground names and symbols, and added 50- Ω resistor series resistor on OSC_SYNC line, on TAS5424A application schematic	37
• Added subsection on input filter design. New recommendation for IN_M impedance on TAS5414A	38
• Added Line Driver application subsection	38
• Added a new section for electrical connection of the heat slug	39
<hr/>	
Changes from Revision B (January 2010) to Revision C	Page
• Changed AGND to GND for the $V_{\text{AIN_DC}}$ description in the Abs Max Table	7
• Added V_{GND} to the Abs Max Table	7
• Changed DGND to GND in I ² C Serial Communication Bus Section	21
• Changed SGND to GND in Figure 27	36
• Changed SGND to GND in Figure 28	37

PACKAGING INFORMATION

Orderable Device	Status (1)	Package Type	Package Drawing	Pins	Package Qty	Eco Plan (2)	Lead finish/ Ball material (6)	MSL Peak Temp (3)	Op Temp (°C)	Device Marking (4/5)	Samples
HPA00838ATPHDRQ1	NRND	HTQFP	PHD	64	1000	RoHS & Green	NIPDAU	Level-3-260C-168 HR	-40 to 105	TAS5414ATMQ1	
HPA01140ATPHDRMQ1	NRND	HTQFP	PHD	64		RoHS (In work) & Non-Green	Call TI	Call TI	-40 to 105		
TAS5414ATDKDMQ1	NRND	HSSOP	DKD	36	29	RoHS & Green	NIPDAU	Level-3-245C-168 HR	-40 to 105	TAS5414ATMQ1	
TAS5414ATDKDQ1	NRND	HSSOP	DKD	36	29	RoHS & Green	NIPDAU	Level-3-245C-168 HR	-40 to 105	TAS5414ATQ1	
TAS5414ATDKDQ1G4	NRND	HSSOP	DKD	36	29	RoHS & Green	NIPDAU	Level-3-245C-168 HR	-40 to 105	TAS5414ATQ1	
TAS5414ATDKDRMQ1	NRND	HSSOP	DKD	36	500	RoHS & Green	NIPDAU	Level-3-245C-168 HR	-40 to 105	TAS5414ATMQ1	
TAS5414ATDKDRQ1	NRND	HSSOP	DKD	36	500	RoHS & Green	NIPDAU	Level-3-245C-168 HR	-40 to 105	TAS5414ATQ1	
TAS5414ATPHDMQ1	NRND	HTQFP	PHD	64	90	RoHS & Green	NIPDAU	Level-3-260C-168 HR	-40 to 105	TAS5414ATMQ1	
TAS5414ATPHDQ1	NRND	HTQFP	PHD	64	90	RoHS & Green	NIPDAU	Level-3-260C-168 HR	-40 to 105	TAS5414ATQ1	
TAS5414ATPHDRMQ1	NRND	HTQFP	PHD	64	1000	RoHS & Green	NIPDAU	Level-3-260C-168 HR	-40 to 105	TAS5414ATMQ1	
TAS5424ATDKDMQ1	ACTIVE	HSSOP	DKD	44	29	RoHS & Green	NIPDAU	Level-3-245C-168 HR	-40 to 105	TAS5424ATMQ1	Samples
TAS5424ATDKDQ1	ACTIVE	HSSOP	DKD	44	29	RoHS & Green	NIPDAU	Level-3-245C-168 HR	-40 to 105	TAS5424ATQ1	Samples
TAS5424ATDKDRMQ1	ACTIVE	HSSOP	DKD	44	500	RoHS & Green	NIPDAU	Level-3-245C-168 HR	-40 to 105	TAS5424ATMQ1	Samples
TAS5424ATDKDRQ1	ACTIVE	HSSOP	DKD	44	500	RoHS & Green	NIPDAU	Level-3-245C-168 HR	-40 to 105	TAS5424ATQ1	Samples
TAS5424ATDKDRQ1G4	ACTIVE	HSSOP	DKD	44	500	RoHS & Green	NIPDAU	Level-3-245C-168 HR	-40 to 105	TAS5424ATQ1	Samples

(1) The marketing status values are defined as follows:

ACTIVE: Product device recommended for new designs.

LIFEBUY: TI has announced that the device will be discontinued, and a lifetime-buy period is in effect.

NRND: Not recommended for new designs. Device is in production to support existing customers, but TI does not recommend using this part in a new design.

PREVIEW: Device has been announced but is not in production. Samples may or may not be available.

OBsolete: TI has discontinued the production of the device.

(2) **RoHS:** TI defines "RoHS" to mean semiconductor products that are compliant with the current EU RoHS requirements for all 10 RoHS substances, including the requirement that RoHS substance do not exceed 0.1% by weight in homogeneous materials. Where designed to be soldered at high temperatures, "RoHS" products are suitable for use in specified lead-free processes. TI may reference these types of products as "Pb-Free".

RoHS Exempt: TI defines "RoHS Exempt" to mean products that contain lead but are compliant with EU RoHS pursuant to a specific EU RoHS exemption.

Green: TI defines "Green" to mean the content of Chlorine (Cl) and Bromine (Br) based flame retardants meet JS709B low halogen requirements of <=1000ppm threshold. Antimony trioxide based flame retardants must also meet the <=1000ppm threshold requirement.

- (3) MSL, Peak Temp. - The Moisture Sensitivity Level rating according to the JEDEC industry standard classifications, and peak solder temperature.
- (4) There may be additional marking, which relates to the logo, the lot trace code information, or the environmental category on the device.
- (5) Multiple Device Markings will be inside parentheses. Only one Device Marking contained in parentheses and separated by a "~" will appear on a device. If a line is indented then it is a continuation of the previous line and the two combined represent the entire Device Marking for that device.
- (6) Lead finish/Ball material - Orderable Devices may have multiple material finish options. Finish options are separated by a vertical ruled line. Lead finish/Ball material values may wrap to two lines if the finish value exceeds the maximum column width.

Important Information and Disclaimer:The information provided on this page represents TI's knowledge and belief as of the date that it is provided. TI bases its knowledge and belief on information provided by third parties, and makes no representation or warranty as to the accuracy of such information. Efforts are underway to better integrate information from third parties. TI has taken and continues to take reasonable steps to provide representative and accurate information but may not have conducted destructive testing or chemical analysis on incoming materials and chemicals. TI and TI suppliers consider certain information to be proprietary, and thus CAS numbers and other limited information may not be available for release.

In no event shall TI's liability arising out of such information exceed the total purchase price of the TI part(s) at issue in this document sold by TI to Customer on an annual basis.

TAPE AND REEL INFORMATION



QUADRANT ASSIGNMENTS FOR PIN 1 ORIENTATION IN TAPE



*All dimensions are nominal

Device	Package Type	Package Drawing	Pins	SPQ	Reel Diameter (mm)	Reel Width W1 (mm)	A0 (mm)	B0 (mm)	K0 (mm)	P1 (mm)	W (mm)	Pin1 Quadrant
TAS5414ATDKDRMQ1	HSSOP	DKD	36	500	330.0	24.4	14.7	16.4	4.0	20.0	24.0	Q1
TAS5414ATDKDRQ1	HSSOP	DKD	36	500	330.0	24.4	14.7	16.4	4.0	20.0	24.0	Q1
TAS5414ATPHDRMQ1	HTQFP	PHD	64	1000	330.0	24.4	17.0	17.0	1.5	20.0	24.0	Q2
TAS5424ATDKDRMQ1	HSSOP	DKD	44	500	330.0	24.4	14.7	16.4	4.0	20.0	24.0	Q1
TAS5424ATDKDRQ1	HSSOP	DKD	44	500	330.0	24.4	14.7	16.4	4.0	20.0	24.0	Q1

TAPE AND REEL BOX DIMENSIONS

*All dimensions are nominal

Device	Package Type	Package Drawing	Pins	SPQ	Length (mm)	Width (mm)	Height (mm)
TAS5414ATDKDRMQ1	HSSOP	DKD	36	500	350.0	350.0	43.0
TAS5414ATDKDRQ1	HSSOP	DKD	36	500	350.0	350.0	43.0
TAS5414ATPHDRMQ1	HTQFP	PHD	64	1000	350.0	350.0	43.0
TAS5424ATDKDRMQ1	HSSOP	DKD	44	500	350.0	350.0	43.0
TAS5424ATDKDRQ1	HSSOP	DKD	44	500	350.0	350.0	43.0

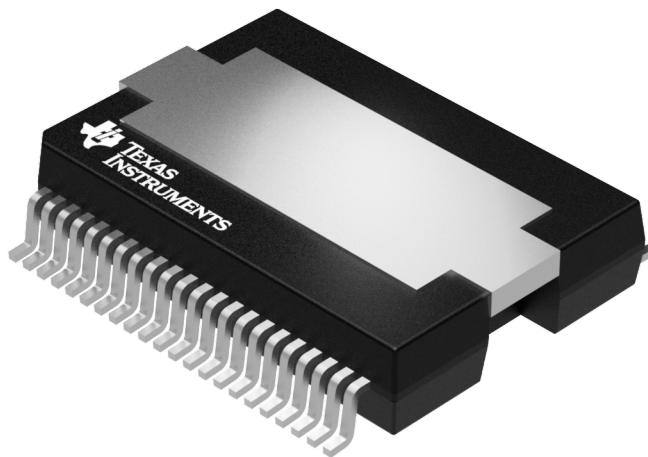

Images above are just a representation of the package family, actual package may vary.
Refer to the product data sheet for package details.

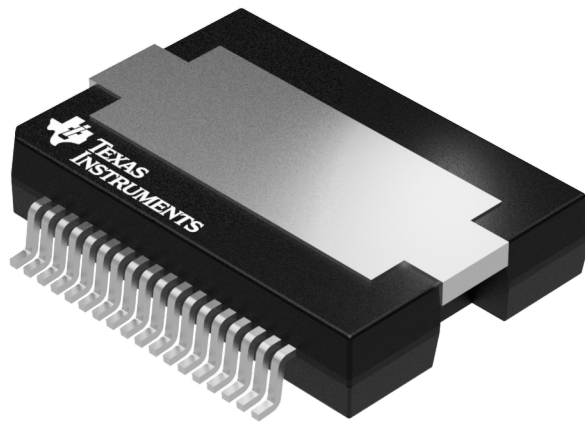

Images above are just a representation of the package family, actual package may vary.
Refer to the product data sheet for package details.

EXAMPLE BOARD LAYOUT

DKD0036A

PowerPAD™ SSOP - 3.6 mm max height

PLASTIC SMALL OUTLINE

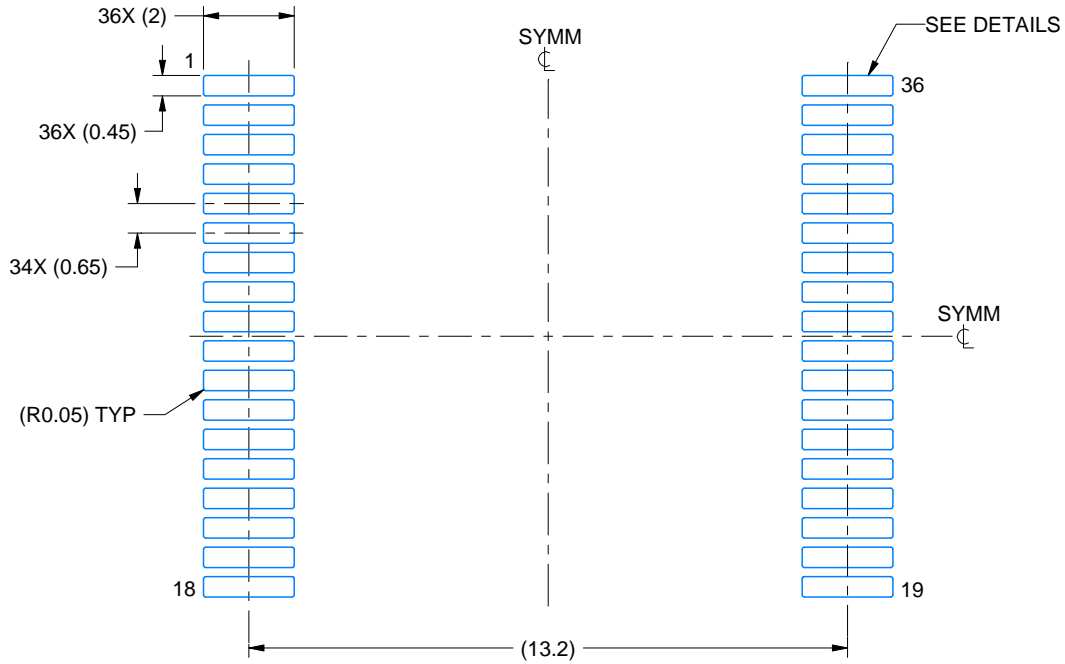

LAND PATTERN EXAMPLE
EXPOSED METAL SHOWN
SCALE:6X

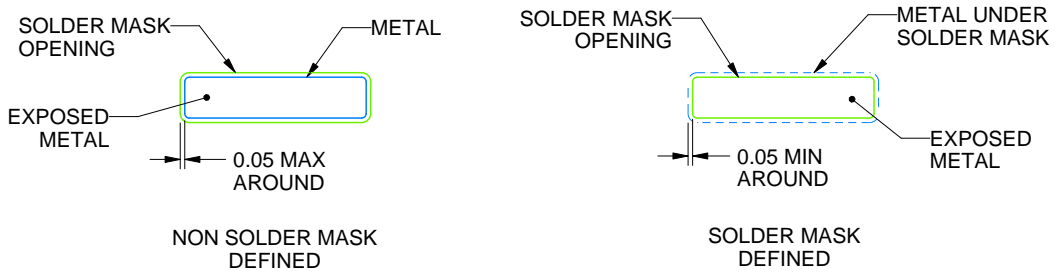

SOLDER MASK DETAILS
NOT TO SCALE

4222166/B 06/2017

NOTES: (continued)

- 5. Publication IPC-7351 may have alternate designs.
- 6. Solder mask tolerances between and around signal pads can vary based on board fabrication site.

EXAMPLE STENCIL DESIGN

DKD0036A

PowerPAD™ SSOP - 3.6 mm max height

PLASTIC SMALL OUTLINE

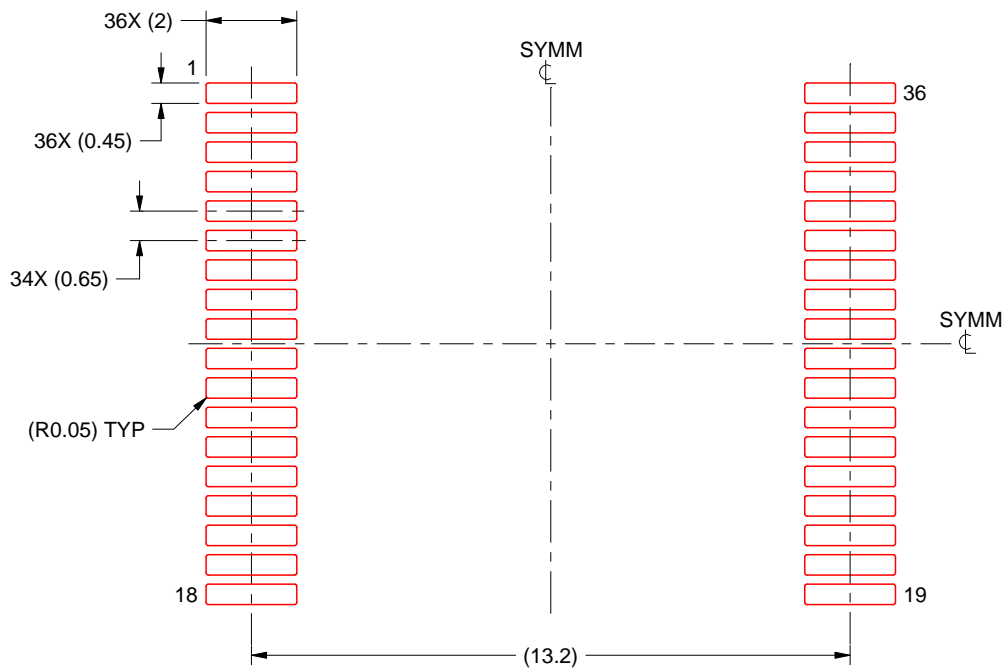

SOLDER PASTE EXAMPLE
BASED ON 0.125 MM THICK STENCIL
SCALE:6X

4222166/B 06/2017

NOTES: (continued)

7. Laser cutting apertures with trapezoidal walls and rounded corners may offer better paste release. IPC-7525 may have alternate design recommendations.
8. Board assembly site may have different recommendations for stencil design.

GENERIC PACKAGE VIEW

PHD 64

HTQFP - 1.20 mm max height

14 x 14, 0.8 mm pitch

QUAD FLATPACK

This image is a representation of the package family, actual package may vary.
Refer to the product data sheet for package details.

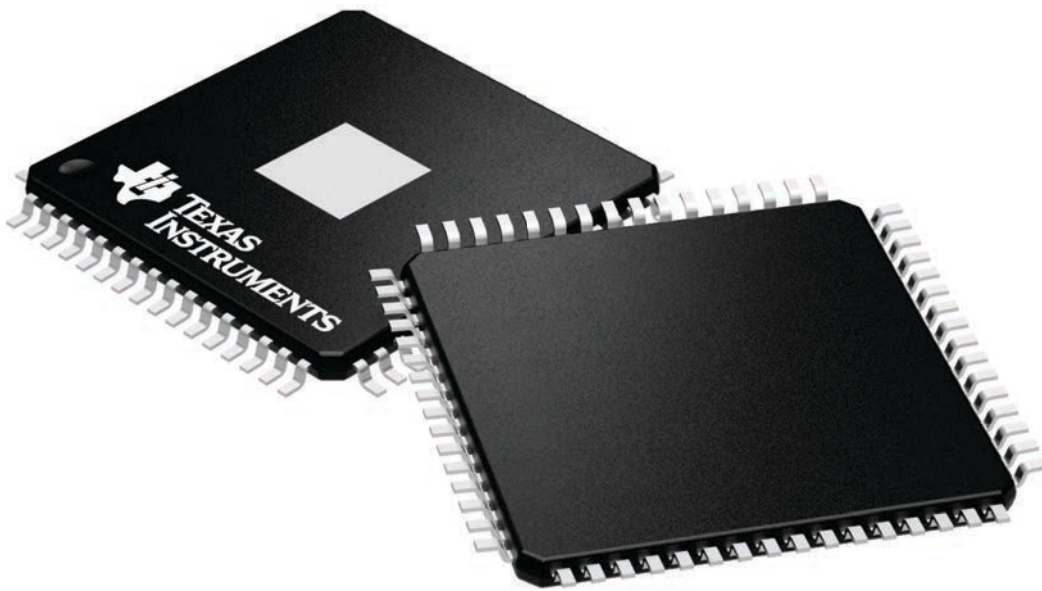

4224851/A

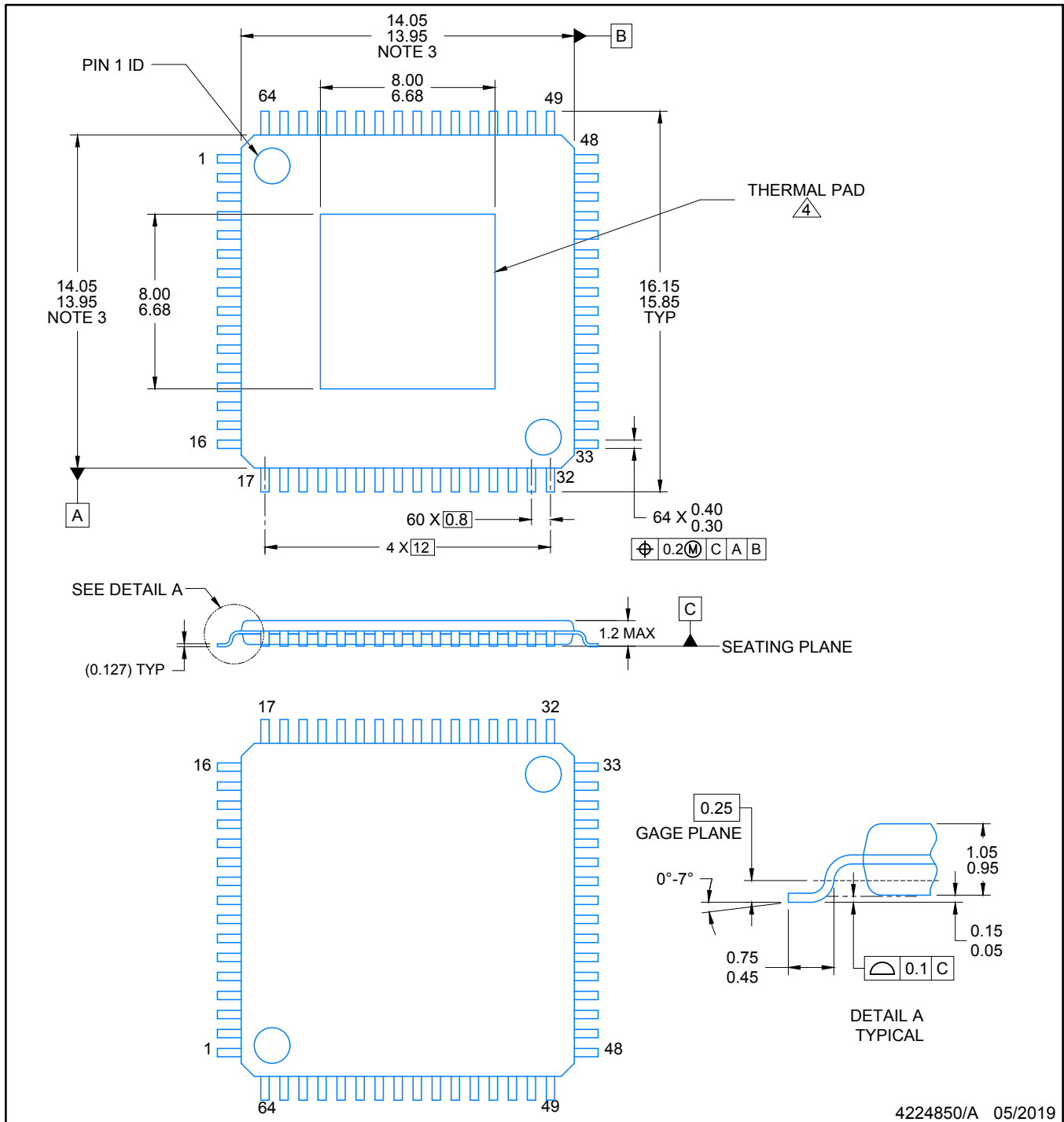

4224850/A 05/2019

NOTES:

1. All linear dimensions are in millimeters. Any dimensions in parenthesis are for reference only. Dimensioning and tolerancing per ASME Y14.5M.
2. This drawing is subject to change without notice.
3. This dimension does not include mold flash, protrusions, or gate burrs. Mold flash, protrusions, or gate burrs shall not exceed 0.15 per side.
4. See technical brief, PowerPad Thermally Enhanced Package, Texas Instruments Literature No. SLMA002 (www.ti.com/lit/slma002) and SLMA004 (www.ti.com/lit/slma004) for information regarding recommended board layout.

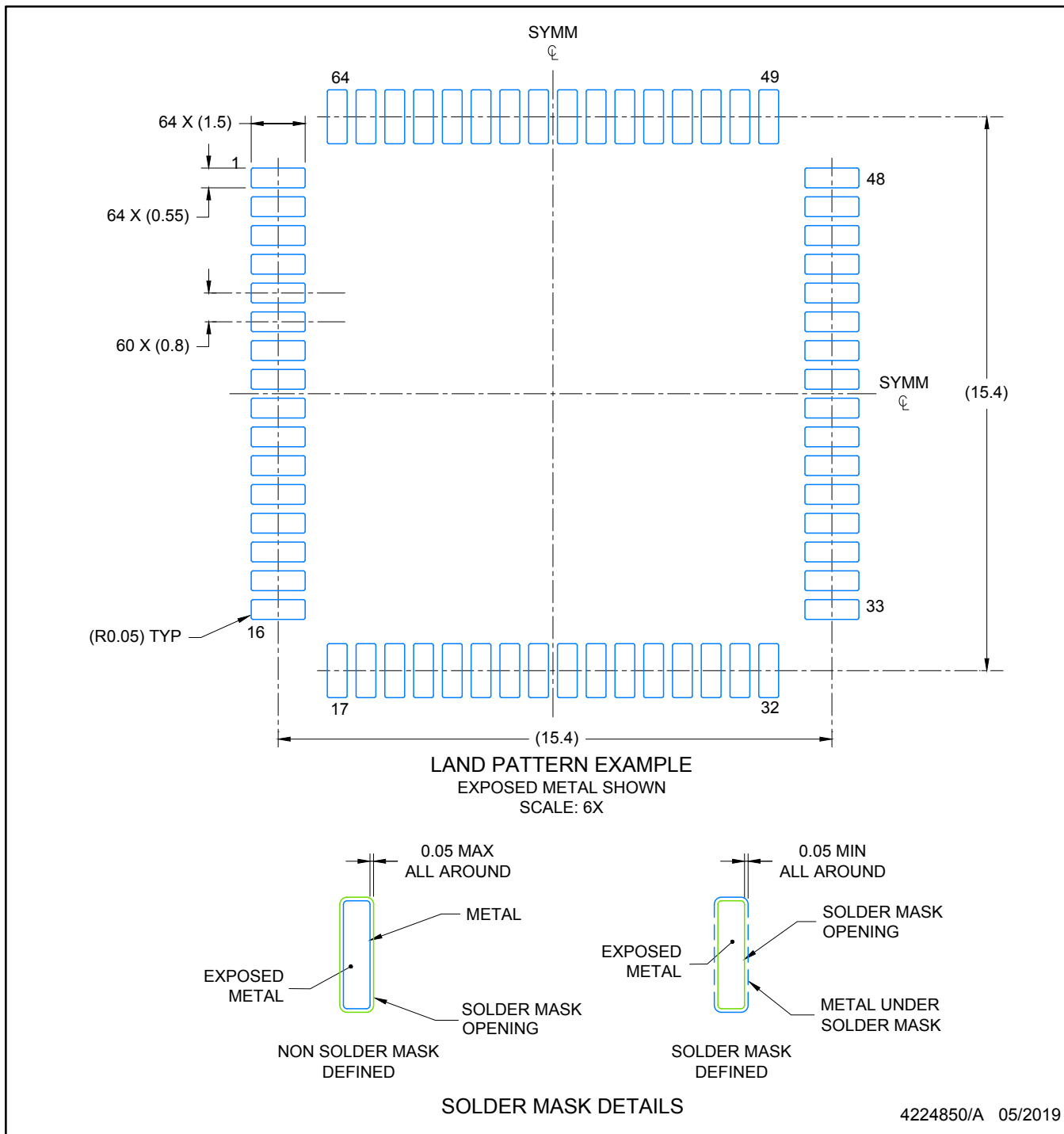

NOTES: (continued)

5. Publication IPC-7351 may have alternate designs.
6. Solder mask tolerances between and around signal pads can vary based on board fabrication site.
7. Vias are optional depending on application, refer to device data sheet. It is recommended that vias under paste be filled, plugged or tented.

EXAMPLE STENCIL DESIGN

HTQFP - 1.2 mm max height

PHD0064B

PLASTIC QUAD FLATPACK

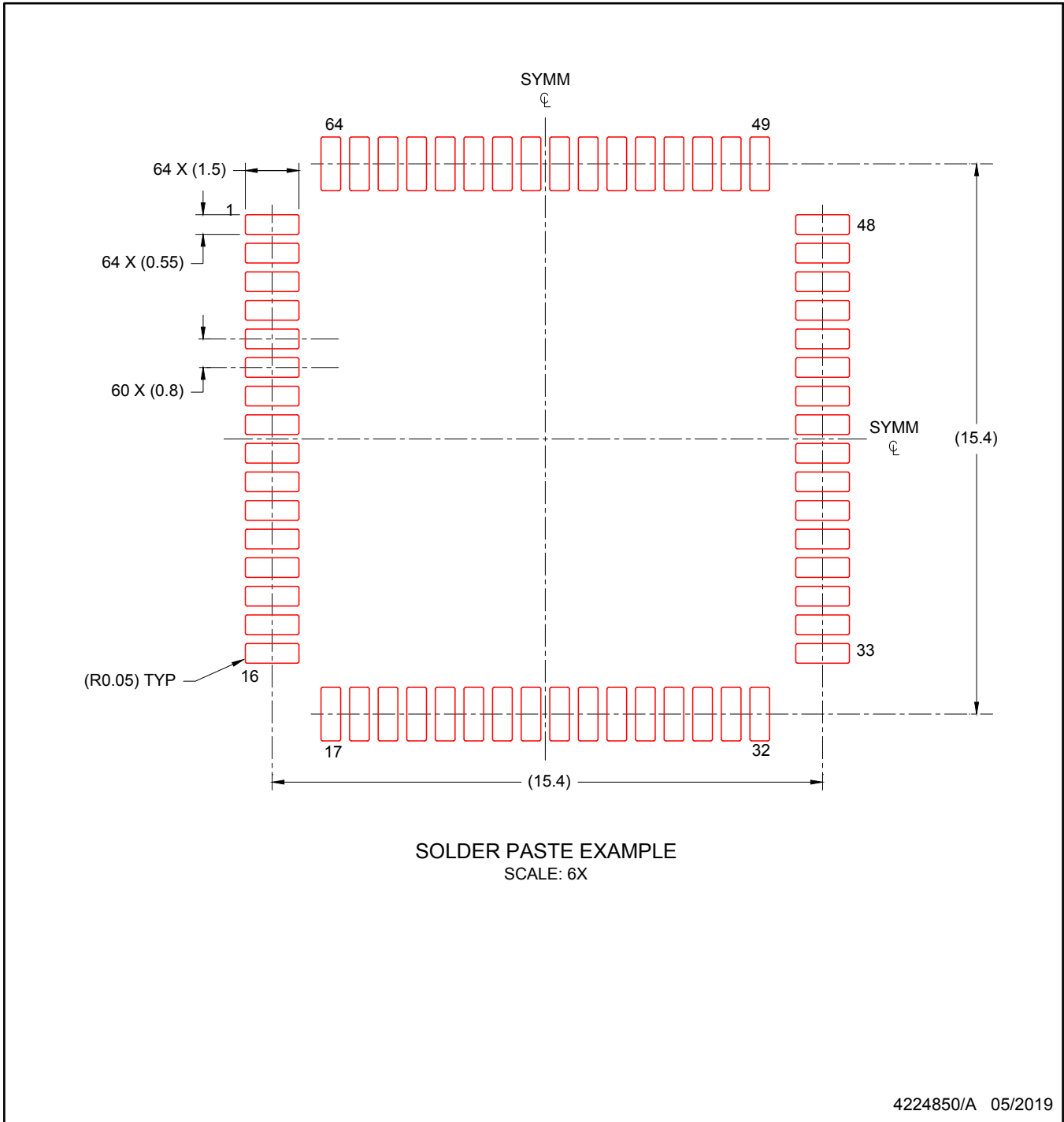

NOTES: (continued)

7. Laser cutting apertures with trapezoidal walls and rounded corners may offer better paste release. IPC-7525 may have alternate design recommendations.
8. Board assembly site may have different recommendations for stencil design.

IMPORTANT NOTICE AND DISCLAIMER

TI PROVIDES TECHNICAL AND RELIABILITY DATA (INCLUDING DATASHEETS), DESIGN RESOURCES (INCLUDING REFERENCE DESIGNS), APPLICATION OR OTHER DESIGN ADVICE, WEB TOOLS, SAFETY INFORMATION, AND OTHER RESOURCES "AS IS" AND WITH ALL FAULTS, AND DISCLAIMS ALL WARRANTIES, EXPRESS AND IMPLIED, INCLUDING WITHOUT LIMITATION ANY IMPLIED WARRANTIES OF MERCHANTABILITY, FITNESS FOR A PARTICULAR PURPOSE OR NON-INFRINGEMENT OF THIRD PARTY INTELLECTUAL PROPERTY RIGHTS.

These resources are intended for skilled developers designing with TI products. You are solely responsible for (1) selecting the appropriate TI products for your application, (2) designing, validating and testing your application, and (3) ensuring your application meets applicable standards, and any other safety, security, or other requirements. These resources are subject to change without notice. TI grants you permission to use these resources only for development of an application that uses the TI products described in the resource. Other reproduction and display of these resources is prohibited. No license is granted to any other TI intellectual property right or to any third party intellectual property right. TI disclaims responsibility for, and you will fully indemnify TI and its representatives against, any claims, damages, costs, losses, and liabilities arising out of your use of these resources.

TI's products are provided subject to TI's Terms of Sale (www.ti.com/legal/termsofsale.html) or other applicable terms available either on ti.com or provided in conjunction with such TI products. TI's provision of these resources does not expand or otherwise alter TI's applicable warranties or warranty disclaimers for TI products.

Mailing Address: Texas Instruments, Post Office Box 655303, Dallas, Texas 75265
Copyright © 2020, Texas Instruments Incorporated