



E-PHEMT Transistor

TAV-541+

THE BIG DEAL

- Low Noise Figure, 0.5 dB
- Gain, 17 dB at 2 GHz
- High Output IP3, +33 dBm
- Output Power at 1dB comp., +19 dBm
- High Current, 60mA
- Wide bandwidth
- External biasing and matching required



Generic photo used for illustration purposes only

CASE STYLE: FG873

+RoHS Compliant

The +Suffix identifies RoHS Compliance. See our web site for RoHS Compliance methodologies and qualifications

APPLICATIONS

- Cellular
- ISM
- GSM
- WCDMA
- WiMax
- WLAN
- UNII and HIPERLAN

PRODUCT OVERVIEW

TAV-541+ is an ultra-low noise, high IP3 transistor device, manufactured using E-PHEMT* technology enabling it to work with a single positive supply voltage. It has outstanding Noise Figure, particularly below 2.5 GHz, and when combining this noise figure with high IP3 performance in a single device it makes it an ideal amplifier for demanding base station applications. We offer these units assembled into a complete module, 50Ω in/out, noise matched and fully specified. For more information please see our TAMP family of models on our web site.

KEY FEATURES

Feature	Advantages
Wideband, 0.045 to 6 GHz	Use in multiple applications: UHF, VHF, communication infrastructure
High Gain, Low noise figure	High Gain limits the effect of noise figure due to previous stages
Small size, 1.18 x 1.42 x 0.85 mm, MCLP package	Small foot print saves space in dense layouts while providing low inductance, repeatable transitions, and excellent thermal contact to the PCB.

* Enhancement mode Pseudomorphic High Electron Mobility Transistor.



ULTRA LOW NOISE, HIGH CURRENT

E-PHEMT Transistor

TAV-541+

Mini-Circuits

ELECTRICAL SPECIFICATIONS AT $T_{AMB}=25^{\circ}\text{C}$, FREQUENCY 0.45 TO 6 GHz

Symbol	Parameter	Condition	Min.	Typ.	Max.	Units	
DC Specifications							
V_{GS}	Operational Gate Voltage	$V_{DS}=3\text{V}, I_{DS}=60\text{ mA}$	0.37	0.48	0.69	V	
V_{TH}	Threshold Voltage	$V_{DS}=3\text{V}, I_{DS}=4\text{ mA}$	0.18	0.26	0.38	V	
I_{DSS}	Saturated Drain Current	$V_{DS}=3\text{V}, V_{GS}=0\text{ V}$	—	1.0	5.0	μA	
G_M	Transconductance	$V_{DS}=3\text{V}, G_m=\Delta I_{DS}/\Delta V_{GS}$ $\Delta V_{GS}=V_{GS1}-V_{GS2}$ $V_{GS1}=V_{GS}$ at $I_{DS}=60\text{ mA}$ $V_{GS2}=V_{GS1}+0.05\text{V}$	— — 230 —	— — 392 —	— — 560 —	mS	
I_{GSS}	Gate leakage Current	$V_{GD}=V_{GS}=-3\text{V}$	—	—	200	μA	
RF Specifications, $Z_0=50\text{ Ohms}$ (Figure 1)							
$NF^{(1)}$	Noise Figure	$V_{DS}=3\text{V}, I_{DS}=60\text{ mA}$	f=0.9 GHz	0.4	—	dB	
			f=2.0 GHz	0.5	0.9		
			f=3.9 GHz	1.0	—		
			f=5.8 GHz	1.8	—		
		$V_{DS}=4\text{V}, I_{DS}=60\text{ mA}$	f=2.0 GHz	0.4	—		
Gain	Gain	$V_{DS}=3\text{V}, I_{DS}=60\text{ mA}$	f=0.9 GHz	—	23.8	dB	
			f=2.0 GHz	15.5	17.9		18.9
			f=3.9 GHz	—	12.7		—
			f=5.8 GHz	—	9.5		—
		$V_{DS}=4\text{V}, I_{DS}=60\text{ mA}$	f=2.0 GHz	—	18.0		
OIP3	Output IP3	$V_{DS}=3\text{V}, I_{DS}=60\text{ mA}$	f=0.9 GHz	—	32.1	dBm	
			f=2.0 GHz	30.0	33.6		—
			f=3.9 GHz	—	34.2		—
			f=5.8 GHz	—	32.9		—
		$V_{DS}=4\text{V}, I_{DS}=60\text{ mA}$	f=2.0 GHz	—	35.9		
P1dB ⁽²⁾	Power output at 1 dB Compression	$V_{DS}=3\text{V}, I_{DS}=60\text{ mA}$	f=0.9 GHz	—	18.9	dBm	
			f=2.0 GHz	—	19.1		—
			f=3.9 GHz	—	19.4		—
			f=5.8 GHz	—	19.6		—
			$V_{DS}=4\text{V}, I_{DS}=60\text{ mA}$	f=2.0 GHz	—		21.1



ULTRA LOW NOISE, HIGH CURRENT

E-PHEMT Transistor

TAV-541+

MAXIMUM RATINGS⁽³⁾

Symbol	Parameter	Max.	Units
$V_{DS}^{(4)}$	Drain-Source Voltage	5	V
$V_{GS}^{(4)}$	Gate-Source Voltage	-5 to 0.7	V
$V_{GD}^{(4)}$	Gate-Drain Voltage	-5 to 0.7	V
$I_{DS}^{(4)}$	Drain Current	120	mA
I_{GS}	Gate Current	2	mA
P_{DISS}	Total Dissipated Power	550	mW
$P_{IN}^{(5)}$	RF Input Power	17	dBm
T_{CH}	Channel Temperature	150	°C
T_{OP}	Operating Temperature	-40 to 85	°C
T_{STD}	Storage Temperature	-65 to 150	°C
Θ_{JC}	Thermal Resistance	112	°C/W

- (1) Includes test board loss (measured in test board TB-154).
- (2) Drain current bias allowed to increase during compression measurement.
- (3) Operation of this device above any one of these parameters may cause permanent damage.
- (4) Assumes DC quiescent conditions.
- (5) I_{GS} is limited to 2 mA during test.

SIMPLIFIED SCHEMATIC AND PAD DESCRIPTION

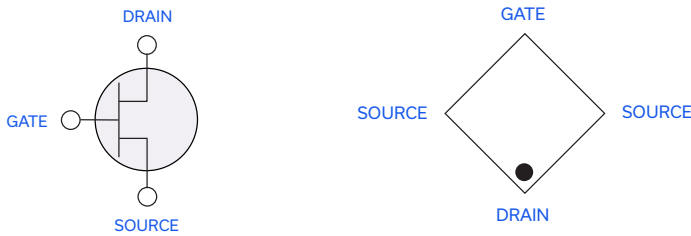

Function	Pad Number	Description
Source	2 & 4	Source terminal, normally connected to ground
Gate	3	Gate used for RF input
Drain	1	Drain used for RF output



CHARACTERIZATION TEST CIRCUIT

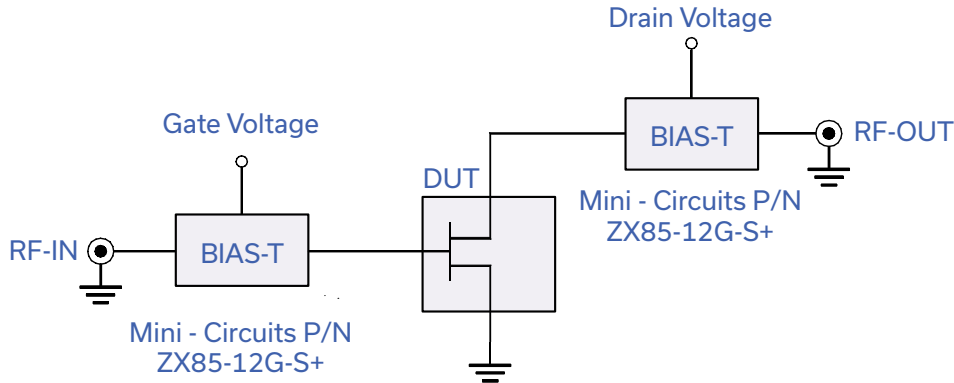

Fig 1. Block Diagram of Test Circuit used for characterization. (DUT soldered on Mini-Circuits Test Board TB-154)

Gain, Output power at 1dB compression (P1 dB) and output IP3 (OIP3) are measured using R&S Network Analyzer ZVA-24. Noise Figure measured using Agilent Noise Figure meter N8975A and Noise Source N4000A.

Conditions:

1. Drain voltage (with reference to source, VDS)= 3 or 4V as shown.
2. Gate Voltage (with reference to source, VGS) is set to obtain desired Drain-Source current (IDS) as shown in graphs or specification table.
3. Gain: Pin= -25dBm
4. Output IP3 (OIP3): Two tones, spaced 1 MHz apart, 0 dBm/tone at output.
5. No external matching components used.

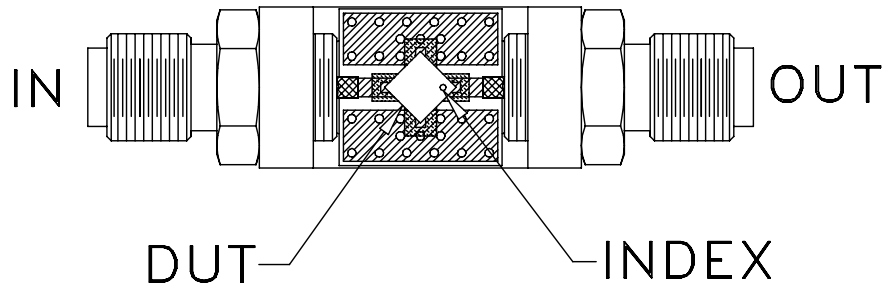

Fig 2. Test Board used for characterization, Mini-Circuits P/N TB-154 (Material: Rogers 4350, Thickness: 0.02")



ULTRA LOW NOISE, HIGH CURRENT

E-PHEMT Transistor

TAV-541+

Mini-Circuits

TYPICAL PERFORMANCE CURVES

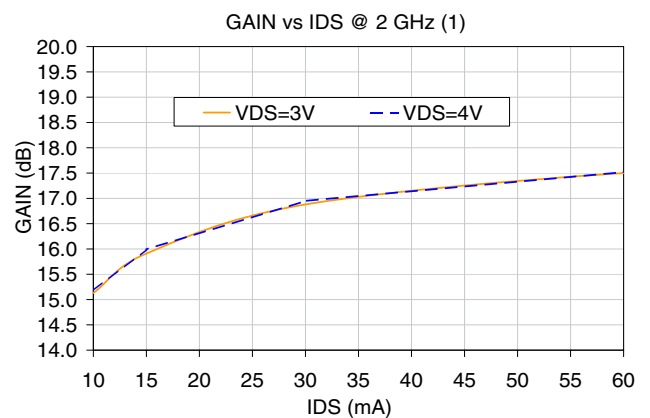
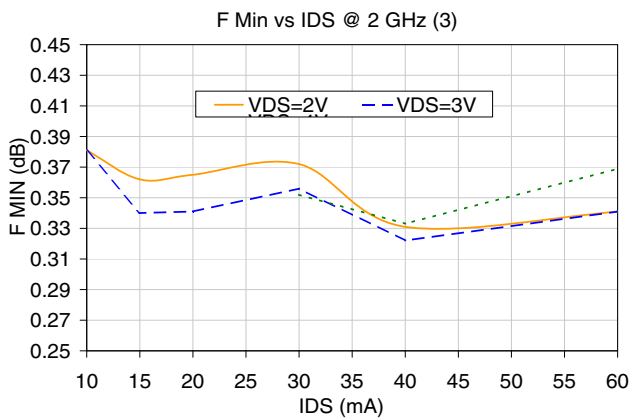
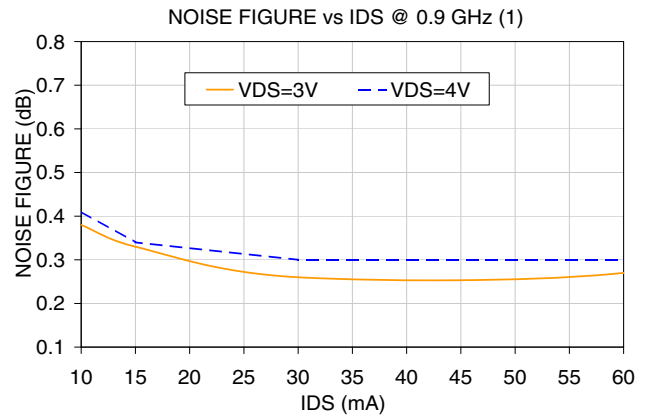
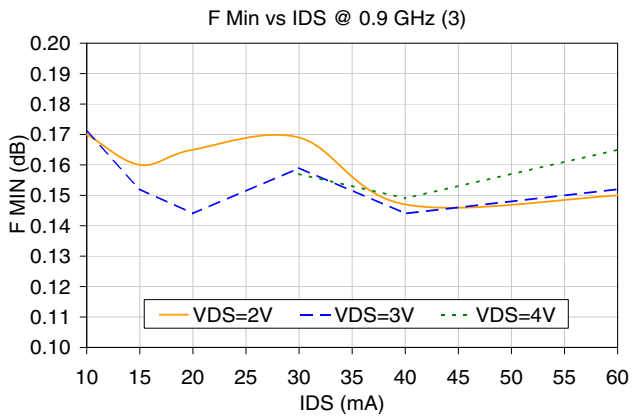
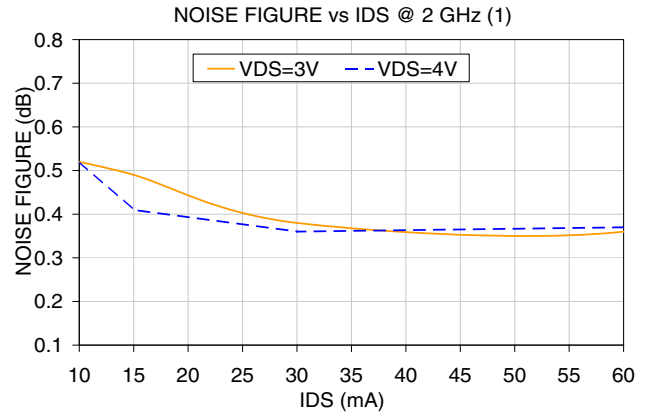
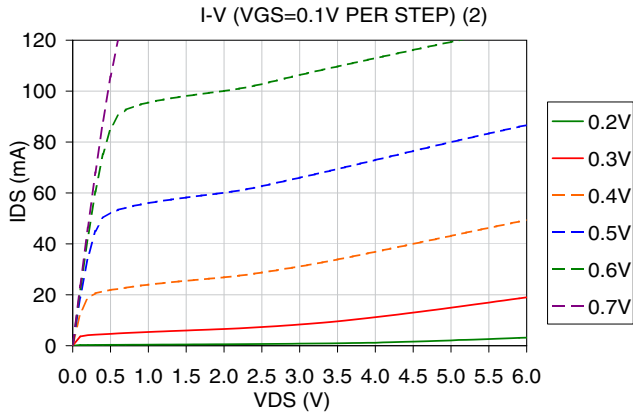

- (1) Includes test board loss, set-up and conditions per Figure 1.
- (2) Measured using HP4155B semiconductor parameter analyzer.
- (3) F Min is minimum Noise Figure
- (4) Draining current was allowed to increase during compression measurement.





TYPICAL PERFORMANCE CURVES

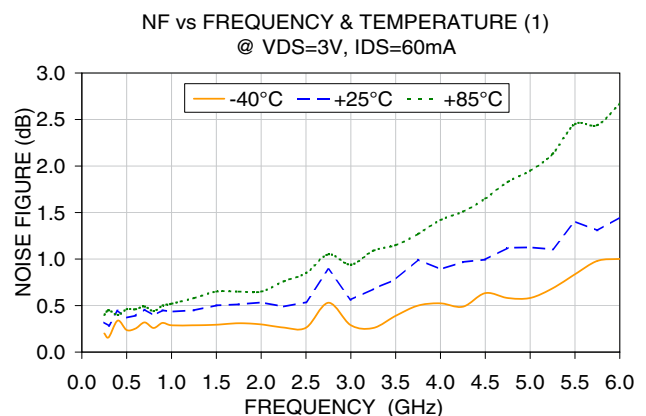
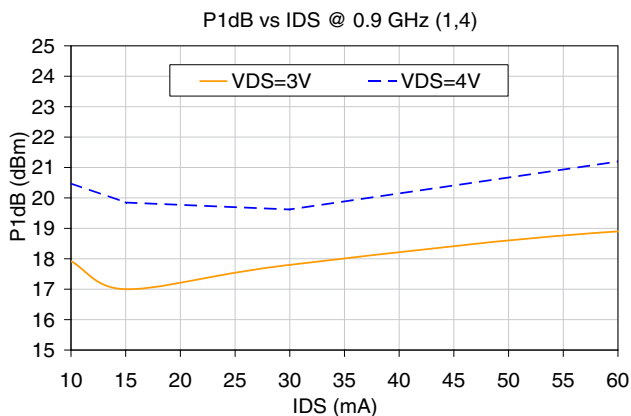
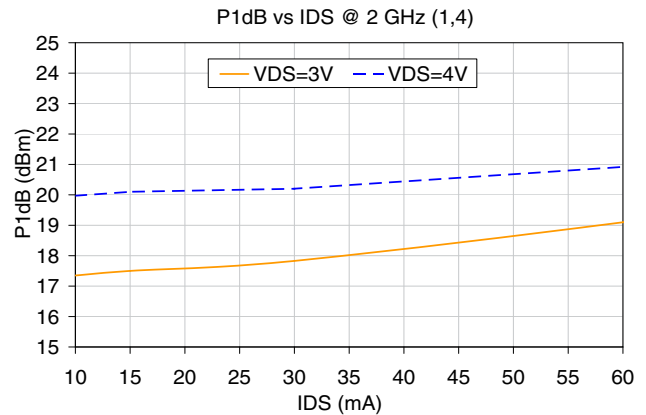
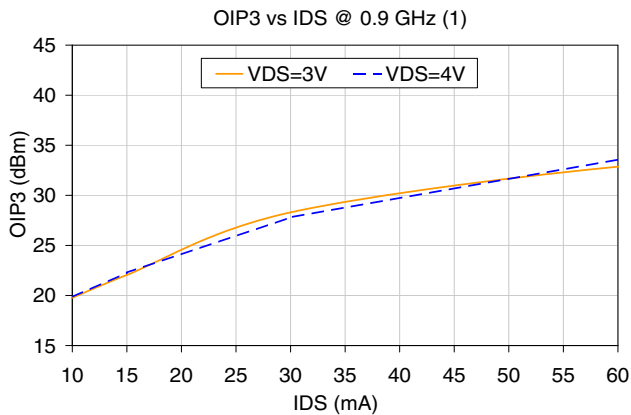
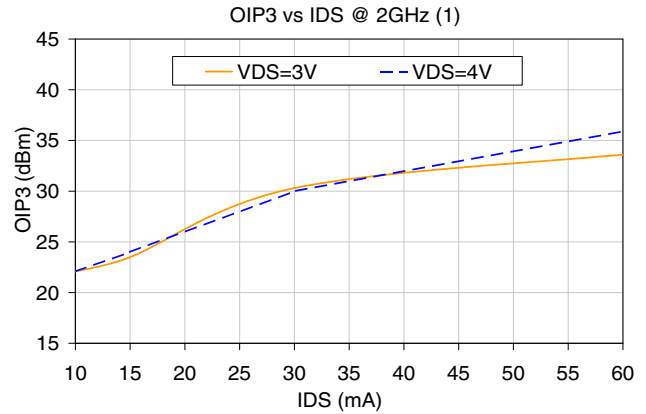
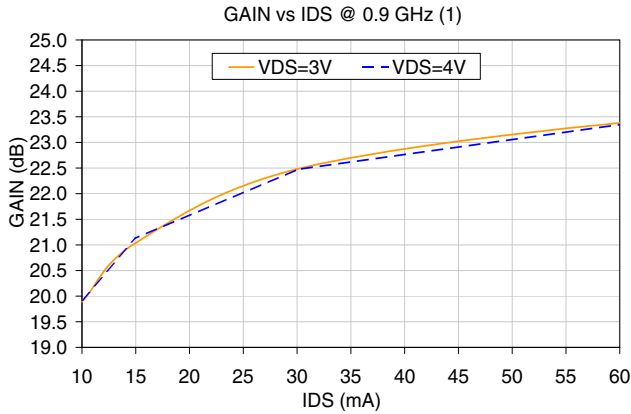

(1) Includes test board loss, set-up and conditions per Figure 1.
 (2) Measured using HP4155B semiconductor parameter analyzer.
 (3) F Min is minimum Noise Figure
 (4) Draining current was allowed to increase during compression measurement.



TYPICAL PERFORMANCE CURVES

GAIN vs FREQUENCY & TEMPERATURE (1)
@ VDS=3V, IDS=60mA

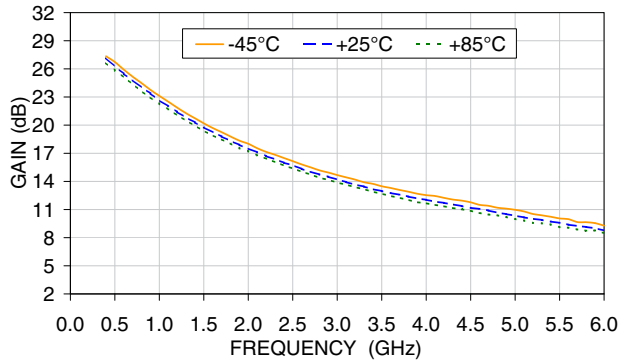

OIP3 vs FREQUENCY & TEMPERATURE (1)
@ VDS=3V, IDS=60mA

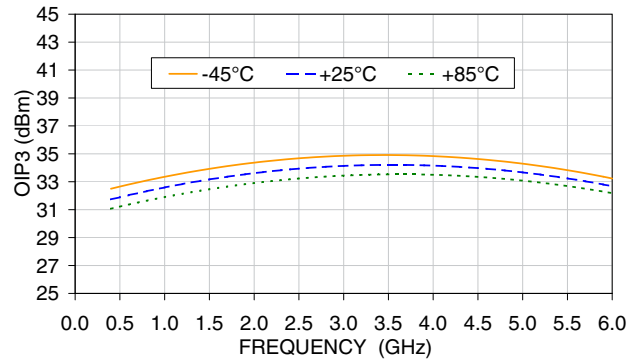

P1dB vs FREQUENCY & TEMPERATURE (1,4)
@ VDS=3V, IDS=60mA

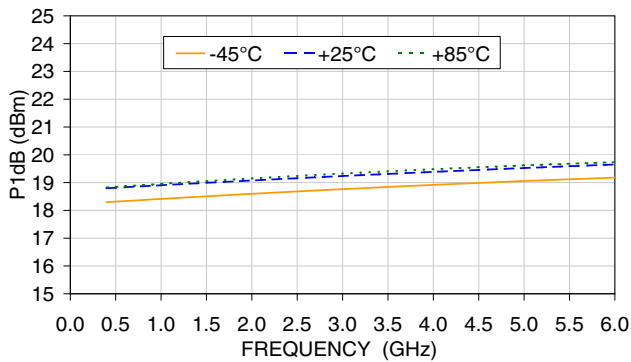

NF vs FREQUENCY & TEMPERATURE (1)
@ VDS=4V, IDS=60mA

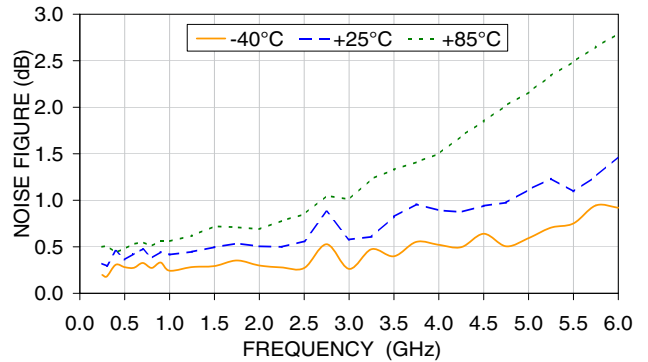

GAIN vs FREQUENCY & TEMPERATURE (1)
@ VDS=4V, IDS=60mA

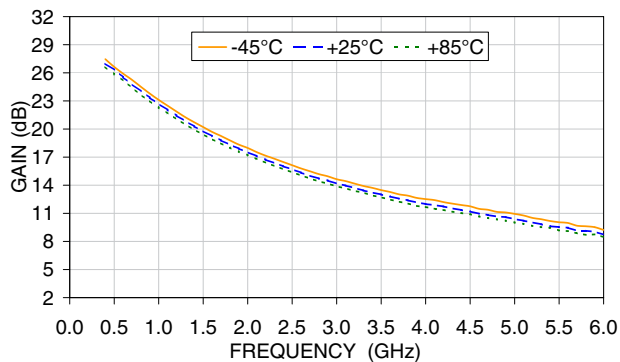

OIP3 vs FREQUENCY & TEMPERATURE (1)
@ VDS=4V, IDS=60mA

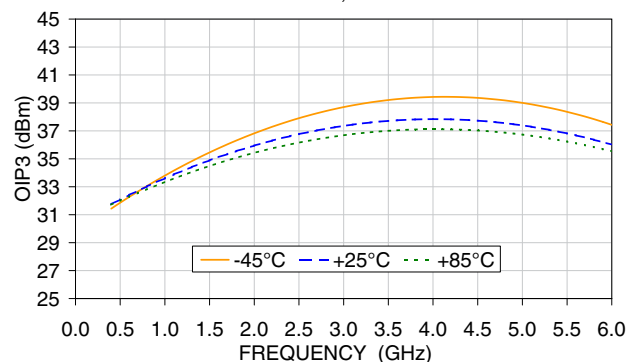

- (1) Includes test board loss, set-up and conditions per Figure 1.
- (2) Measured using HP4155B semiconductor parameter analyzer.
- (3) F Min is minimum Noise Figure
- (4) Draining current was allowed to increase during compression measurement.



TYPICAL PERFORMANCE CURVES

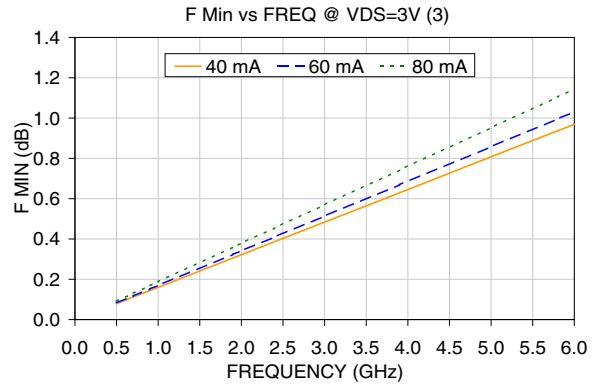
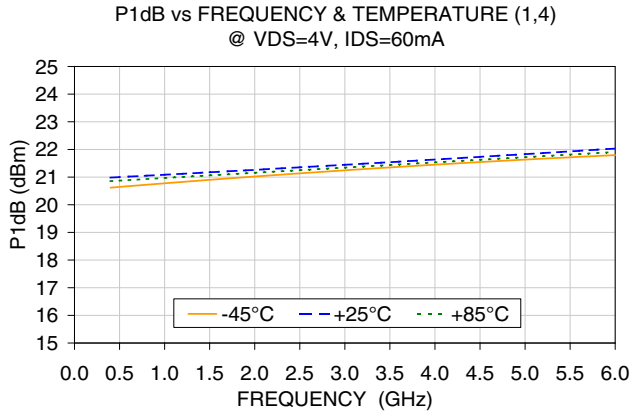

- (1) Includes test board loss, set-up and conditions per Figure 1.
- (2) Measured using HP4155B semiconductor parameter analyzer.
- (3) F Min is minimum Noise Figure
- (4) Draining current was allowed to increase during compression measurement.

REFERENCE PLANE LOCATION FOR S AND NOISE PARAMETERS (SEE DATA IN PAGES 8-11)

(Refer to Application Note AN-60-040)

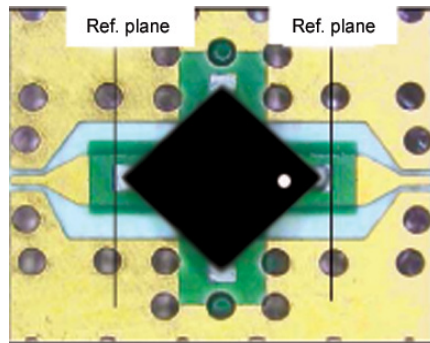

Fig 3. Reference Plane Location

Notes:
Noise parameters were measured over 0.5 to 6 GHz by Modelithics® using a solid state tuner-based NP noise parameter (NP) test system available from Maury Microwave. F Min, optimum source reflection coefficient and noise resistance values are calculated values based on a set of measurements made at approximately 16 different impedances. Some data smoothing was applied to arrive at the presented data set.

S-parameters were measured by Modelithics® on an Anritsu Lightning vector network analyzer over 0.1 to 18GHz using 350um pitch RF probes from GGB industries combined with customized thru-reflect-line (TRL) calibration standards. The reference plane is at the device package leads, as shown in the picture.



ULTRA LOW NOISE, HIGH CURRENT

E-PHEMT Transistor

TAV-541+

Mini-Circuits

TYPICAL S-PARAMETERS, $V_{DS}=3V$ AND $I_{DS}=40$ MA (FIG. 3)

Freq. (GHz)	S11		S21			S12		S22		MSG/MAG (dB)
	Mag.	Ang.	Mag.	Mag (dB)	Ang.	Mag.	Ang.	Mag.	Ang.	
0.1	0.99	-17.2	25.43	28.11	168.9	0.008	88.2	0.56	-14.38	35.0
0.5	0.87	-76.8	19.58	25.84	130.6	0.035	53.0	0.43	-57.19	27.5
0.9	0.76	-115.5	14.13	23.01	106.5	0.046	37.7	0.32	-86.00	24.8
1.0	0.74	-123.3	13.11	22.35	101.9	0.048	34.5	0.30	-92.51	24.4
1.5	0.69	-152.7	9.47	19.53	83.1	0.055	26.3	0.23	-117.37	22.3
1.9	0.67	-170.0	7.69	17.72	71.2	0.06	22.0	0.19	-134.11	21.1
2.0	0.67	-173.7	7.34	17.32	68.5	0.061	21.0	0.19	-138.02	20.8
2.5	0.66	169.4	6.00	15.56	55.6	0.068	16.3	0.16	-156.68	19.5
3.0	0.66	154.6	5.06	14.08	43.7	0.074	11.9	0.15	-174.75	18.4
4.0	0.66	129.3	3.84	11.68	21.3	0.087	2.3	0.14	150.58	15.7
5.0	0.68	106.9	3.10	9.84	0.1	0.1	-8.8	0.15	119.45	13.3
6.0	0.70	86.2	2.60	8.30	-20.5	0.115	-20.9	0.18	92.56	11.8
7.0	0.72	66.4	2.22	6.94	-41.0	0.128	-34.2	0.22	69.55	10.7
8.0	0.75	47.4	1.93	5.70	-61.0	0.139	-48.1	0.27	49.63	9.8
9.0	0.79	28.5	1.68	4.48	-81.0	0.147	-63.3	0.34	31.29	9.2
10.0	0.83	9.5	1.46	3.26	-101.2	0.152	-78.5	0.41	13.77	8.9
11.0	0.86	-9.0	1.26	1.99	-121.1	0.153	-94.1	0.48	-2.86	9.2
12.0	0.89	-26.8	1.08	0.70	-140.7	0.151	-109.7	0.55	-18.99	8.6
13.0	0.91	-44.5	0.93	-0.61	-160.4	0.146	-125.6	0.60	-35.09	8.1
14.0	0.92	-61.1	0.80	-1.97	-179.5	0.139	-141.1	0.65	-50.57	7.6
15.0	0.94	-73.8	0.68	-3.33	164.7	0.13	-153.6	0.70	-62.75	7.2
16.0	0.96	-83.9	0.58	-4.74	151.0	0.119	-163.2	0.74	-73.16	6.9
17.0	0.96	-95.0	0.50	-6.11	136.0	0.11	-174.5	0.77	-85.02	6.5
18.0	0.96	-107.0	0.42	-7.54	120.2	0.101	175.2	0.79	-98.18	6.2

TYPICAL NOISE PARAMETERS, $V_{DS}=3V$ AND $I_{DS}=40$ MA (FIG. 3)

Freq. (GHz)	F Min. (dB)	G _{Opt} (Magnitude)	G _{Opt} (Angle)	R _n /50	G _a Associated Gain (dB)
0.5	0.08	0.33	24.56	0.06	27.6
0.7	0.11	0.33	36.08	0.05	25.5
0.9	0.14	0.34	47.40	0.05	23.7
1.0	0.16	0.34	52.98	0.04	22.9
1.9	0.31	0.37	100.93	0.03	18.2
2.0	0.32	0.37	106.01	0.03	17.8
2.4	0.39	0.38	125.79	0.03	16.6
3.0	0.48	0.40	153.93	0.04	15.1
3.9	0.63	0.43	-167.30	0.06	13.5
5.0	0.81	0.46	-125.53	0.11	12.0
5.8	0.94	0.49	-99.03	0.16	11.1
6.0	0.97	0.50	-92.92	0.18	10.8

F Min.: Minimum Noise Figure
 G_{Opt}: Optimum Source Reflection Coefficient
 R_n: Equivalent noise resistance

MAXIMUM STABLE GAIN (MSG)/MAXIMUM AVAILABLE GAIN (MAG) vs. FREQUENCY

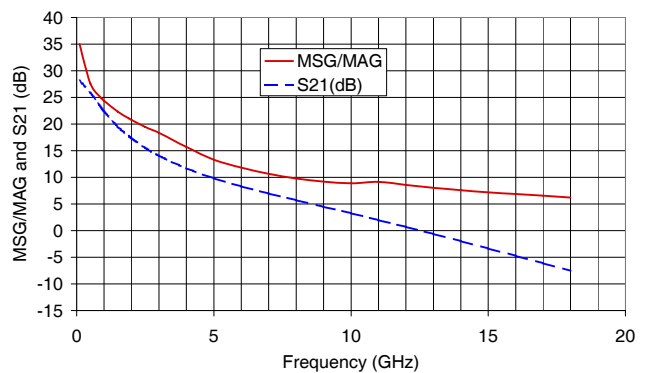



ULTRA LOW NOISE, HIGH CURRENT

E-PHEMT Transistor

TAV-541+

Mini-Circuits

TYPICAL S-PARAMETERS, $V_{DS}=3V$ AND $I_{DS}=60$ MA (FIG. 3)

Freq. (GHz)	S11		S21			S12		S22		MSG/MAG (dB)
	Mag.	Ang.	Mag.	Mag (dB)	Ang.	Mag.	Ang.	Mag.	Ang.	
0.1	1.00	-18.3	28.21	29.01	168.3	0.009	85.7	0.51	-16.71	34.9
0.5	0.85	-80.2	21.11	26.49	128.7	0.032	52.1	0.39	-62.25	28.1
0.9	0.74	-119.0	14.94	23.49	104.9	0.043	38.1	0.29	-93.22	25.5
1.0	0.73	-126.7	13.82	22.81	100.3	0.044	35.5	0.27	-100.07	24.9
1.5	0.68	-155.5	9.90	19.91	82.0	0.052	28.6	0.21	-126.53	22.8
1.9	0.66	-172.3	8.01	18.07	70.4	0.057	25.0	0.18	-144.11	21.5
2.0	0.66	-176.0	7.64	17.67	67.7	0.058	24.3	0.18	-148.27	21.2
2.5	0.65	167.5	6.23	15.89	55.1	0.065	19.8	0.16	-167.22	19.8
3.0	0.65	153.1	5.25	14.40	43.3	0.072	15.3	0.15	174.65	18.6
4.0	0.65	128.2	3.98	12.00	21.3	0.087	5.4	0.15	141.50	15.6
5.0	0.67	106.1	3.21	10.14	0.3	0.102	-6.5	0.17	112.56	13.5
6.0	0.69	85.6	2.69	8.59	-20.1	0.117	-19.1	0.20	87.55	12.0
7.0	0.72	66.0	2.30	7.23	-40.4	0.13	-33.1	0.24	65.85	10.8
8.0	0.75	47.1	1.99	5.98	-60.3	0.142	-47.3	0.29	46.59	9.9
9.0	0.78	28.3	1.73	4.76	-80.1	0.15	-62.8	0.35	28.80	9.3
10.0	0.82	9.4	1.50	3.54	-100.0	0.154	-78.4	0.42	11.67	9.0
11.0	0.86	-9.1	1.30	2.26	-119.7	0.155	-94.2	0.49	-4.75	9.2
12.0	0.89	-26.9	1.12	0.99	-139.3	0.152	-109.8	0.56	-20.66	8.7
13.0	0.91	-44.5	0.97	-0.30	-158.8	0.147	-125.7	0.61	-36.60	8.2
14.0	0.92	-61.1	0.83	-1.63	-177.8	0.139	-141.3	0.66	-52.00	7.7
15.0	0.94	-73.9	0.71	-2.97	166.5	0.132	-154.0	0.71	-64.02	7.3
16.0	0.96	-84.1	0.61	-4.32	152.8	0.12	-163.5	0.74	-74.32	7.1
17.0	0.96	-95.3	0.52	-5.67	138.0	0.11	-174.6	0.77	-85.98	6.8
18.0	0.96	-107.3	0.45	-7.02	122.0	0.102	174.4	0.79	-99.18	6.4

TYPICAL NOISE PARAMETERS, $V_{DS}=3V$ AND $I_{DS}=60$ MA (FIG. 3)

Freq. (GHz)	F Min. (dB)	GOpt (Magnitude)	GOpt (Angle)	Rn/50	Ga Associated Gain (dB)
0.5	0.08	0.30	28.07	0.05	28.1
0.7	0.12	0.31	40.04	0.05	26.0
0.9	0.15	0.31	51.78	0.04	24.3
1.0	0.17	0.32	57.56	0.04	23.5
1.9	0.32	0.34	106.85	0.03	18.7
2.0	0.34	0.35	112.03	0.03	18.3
2.4	0.41	0.36	132.12	0.03	17.1
3.0	0.51	0.38	160.46	0.04	15.6
3.9	0.67	0.41	-161.11	0.06	13.9
5.0	0.86	0.46	-120.77	0.12	12.3
5.8	1.00	0.50	-96.02	0.18	11.3
6.0	1.03	0.50	-90.44	0.20	11.1

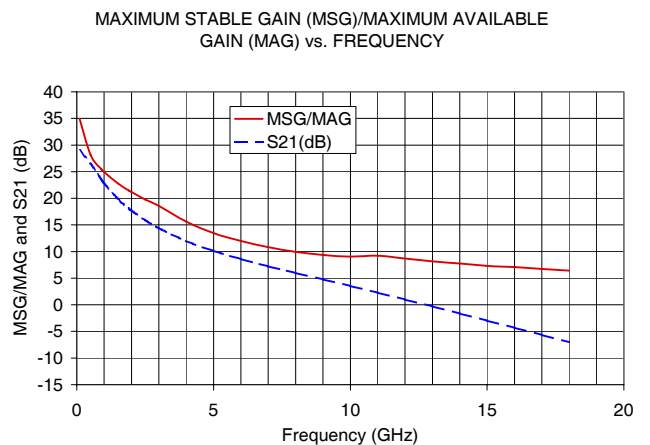

F Min.: Minimum Noise Figure
 GOpt: Optimum Source Reflection Coefficient
 Rn: Equivalent noise resistance





ULTRA LOW NOISE, HIGH CURRENT

E-PHEMT Transistor

TAV-541+

Mini-Circuits

TYPICAL S-PARAMETERS, $V_{DS}=3V$ AND $I_{DS}=80$ MA (FIG. 3)

Freq. (GHz)	S11		S21			S12		S22		MSG/MAG (dB)
	Mag.	Ang.	Mag.	Mag (dB)	Ang.	Mag.	Ang.	Mag.	Ang.	
0.1	0.99	-19.1	29.68	29.45	168.0	0.008	79.9	0.48	-15.91	35.7
0.5	0.84	-81.5	21.98	26.84	127.8	0.03	52.2	0.37	-64.82	28.6
0.9	0.74	-120.4	15.43	23.77	104.1	0.041	39.3	0.27	-96.45	25.8
1.0	0.72	-128.1	14.26	23.08	99.6	0.042	36.9	0.26	-103.52	25.3
1.5	0.67	-156.6	10.17	20.15	81.6	0.05	30.5	0.20	-130.54	23.1
1.9	0.65	-173.2	8.22	18.30	70.0	0.055	26.8	0.18	-148.39	21.7
2.0	0.65	-176.8	7.85	17.89	67.4	0.057	26.1	0.17	-152.41	21.4
2.5	0.65	166.8	6.39	16.12	54.9	0.064	21.9	0.16	-171.38	20.0
3.0	0.65	152.5	5.38	14.62	43.3	0.071	17.3	0.15	170.84	18.8
4.0	0.65	127.8	4.08	12.21	21.4	0.087	7.1	0.15	138.34	15.7
5.0	0.66	105.9	3.29	10.35	0.5	0.102	-5.0	0.17	110.24	13.5
6.0	0.69	85.5	2.75	8.79	-19.8	0.117	-18.3	0.20	85.89	12.1
7.0	0.71	66.0	2.35	7.43	-40.0	0.131	-32.5	0.24	64.54	11.0
8.0	0.74	47.1	2.04	6.19	-59.8	0.142	-46.7	0.30	45.55	10.1
9.0	0.78	28.3	1.77	4.96	-79.5	0.151	-62.4	0.36	27.96	9.5
10.0	0.82	9.4	1.54	3.74	-99.4	0.155	-78.0	0.43	10.98	9.2
11.0	0.85	-9.0	1.33	2.47	-119.0	0.155	-93.9	0.50	-5.36	9.3
12.0	0.88	-26.8	1.15	1.21	-138.5	0.153	-109.6	0.56	-21.19	8.8
13.0	0.91	-44.5	0.99	-0.07	-158.0	0.148	-125.5	0.61	-37.07	8.3
14.0	0.92	-61.1	0.85	-1.39	-176.9	0.14	-141.0	0.66	-52.42	7.8
15.0	0.94	-73.9	0.73	-2.72	167.5	0.132	-154.1	0.71	-64.45	7.4
16.0	0.96	-84.2	0.63	-4.08	153.8	0.12	-163.4	0.74	-74.71	7.2
17.0	0.96	-95.4	0.54	-5.38	138.8	0.11	-174.4	0.77	-86.39	6.9
18.0	0.96	-107.3	0.46	-6.72	122.8	0.102	174.9	0.79	-99.50	6.6

TYPICAL NOISE PARAMETERS, $V_{DS}=3V$ AND $I_{DS}=80$ MA (FIG. 3)

Freq. (GHz)	F Min. (dB)	G _{Opt} (Magnitude)	G _{Opt} (Angle)	Rn/50	G _a Associated Gain (dB)
0.5	0.09	0.33	26.31	0.06	28.3
0.7	0.13	0.33	39.10	0.05	26.2
0.9	0.17	0.33	51.61	0.04	24.5
1.0	0.19	0.33	57.75	0.04	23.7
1.9	0.36	0.33	109.77	0.03	19.0
2.0	0.38	0.33	115.19	0.03	18.6
2.4	0.46	0.34	136.14	0.03	17.4
3.0	0.57	0.36	165.40	0.04	15.9
3.9	0.74	0.39	-155.61	0.07	14.1
5.0	0.95	0.45	-115.93	0.14	12.5
5.8	1.11	0.51	-92.56	0.21	11.5
6.0	1.14	0.52	-87.45	0.23	11.3

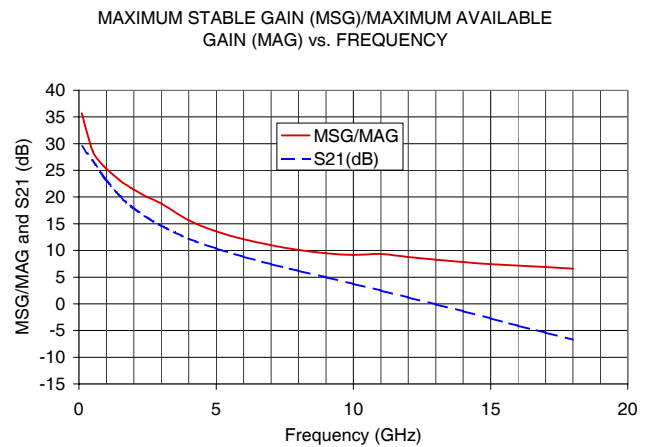

F Min.: Minimum Noise Figure
 G_{Opt}: Optimum Source Reflection Coefficient
 Rn: Equivalent noise resistance





ULTRA LOW NOISE, HIGH CURRENT

E-PHEMT Transistor

TAV-541+

Mini-Circuits

TYPICAL S-PARAMETERS, $V_{DS}=4V$ AND $I_{DS}=60$ MA (FIG. 3)

Freq. (GHz)	S11		S21			S12		S22		MSG/MAG (dB)
	Mag.	Ang.	Mag.	Mag (dB)	Ang.	Mag.	Ang.	Mag.	Ang.	
0.1	0.99	-18.6	28.21	29.01	168.0	0.008	81.4	0.53	-15.16	35.3
0.5	0.85	-80.1	21.15	26.51	128.6	0.032	50.7	0.41	-59.41	28.3
0.9	0.74	-118.9	14.97	23.51	104.8	0.042	38.3	0.29	-88.49	25.5
1.0	0.73	-126.7	13.85	22.83	100.2	0.044	36.0	0.27	-94.84	25.0
1.5	0.68	-155.5	9.92	19.93	81.9	0.051	28.6	0.21	-119.65	22.9
1.9	0.66	-172.3	8.03	18.10	70.3	0.056	24.9	0.18	-136.31	21.6
2.0	0.66	-176.0	7.67	17.69	67.6	0.057	24.2	0.17	-140.21	21.3
2.5	0.65	167.5	6.25	15.92	55.0	0.064	19.8	0.15	-158.90	19.9
3.0	0.65	153.1	5.26	14.42	43.3	0.071	15.5	0.14	-177.02	18.7
4.0	0.65	128.2	3.99	12.02	21.2	0.085	5.7	0.13	148.13	15.7
5.0	0.67	106.1	3.23	10.17	0.2	0.1	-5.8	0.14	117.31	13.5
6.0	0.69	85.6	2.70	8.63	-20.3	0.115	-18.2	0.17	90.98	12.1
7.0	0.72	66.0	2.31	7.28	-40.7	0.128	-32.0	0.21	68.42	11.0
8.0	0.75	47.1	2.01	6.05	-60.7	0.14	-46.1	0.27	48.79	10.1
9.0	0.78	28.3	1.74	4.83	-80.6	0.149	-61.5	0.33	30.75	9.6
10.0	0.82	9.4	1.52	3.62	-100.6	0.154	-76.9	0.40	13.54	9.4
11.0	0.86	-9.1	1.31	2.36	-120.5	0.155	-92.9	0.47	-3.07	9.3
12.0	0.89	-27.0	1.13	1.10	-140.2	0.153	-108.7	0.54	-19.05	8.7
13.0	0.91	-44.7	0.98	-0.20	-160.0	0.148	-124.7	0.60	-35.11	8.2
14.0	0.93	-61.4	0.84	-1.55	-179.2	0.141	-140.4	0.65	-50.62	7.7
15.0	0.94	-74.2	0.72	-2.90	165.0	0.132	-153.2	0.70	-62.85	7.3
16.0	0.96	-84.5	0.61	-4.30	151.1	0.12	-163.0	0.74	-73.26	7.1
17.0	0.96	-95.9	0.52	-5.64	135.9	0.111	-174.2	0.77	-85.15	6.7
18.0	0.96	-107.8	0.44	-7.06	119.8	0.103	174.4	0.79	-98.32	6.4

TYPICAL NOISE PARAMETERS, $V_{DS}=4V$ AND $I_{DS}=60$ MA (FIG. 3)

Freq. (GHz)	F Min. (dB)	GOpt (Magnitude)	GOpt (Angle)	Rn/50	Ga Associated Gain (dB)
0.5	0.09	0.34	30.05	0.06	28.3
0.7	0.13	0.35	41.82	0.05	26.1
0.9	0.17	0.35	53.36	0.04	24.3
1.0	0.18	0.35	59.05	0.04	23.5
1.9	0.35	0.36	107.61	0.03	18.7
2.0	0.37	0.36	112.72	0.03	18.3
2.4	0.44	0.37	132.57	0.03	17.1
3.0	0.56	0.38	160.61	0.04	15.6
3.9	0.72	0.41	-161.21	0.06	13.9
5.0	0.93	0.45	-120.91	0.12	12.3
5.8	1.08	0.49	-95.98	0.18	11.3
6.0	1.11	0.50	-90.33	0.20	11.1

F Min.: Minimum Noise Figure
 GOpt: Optimum Source Reflection Coefficient
 Rn: Equivalent noise resistance

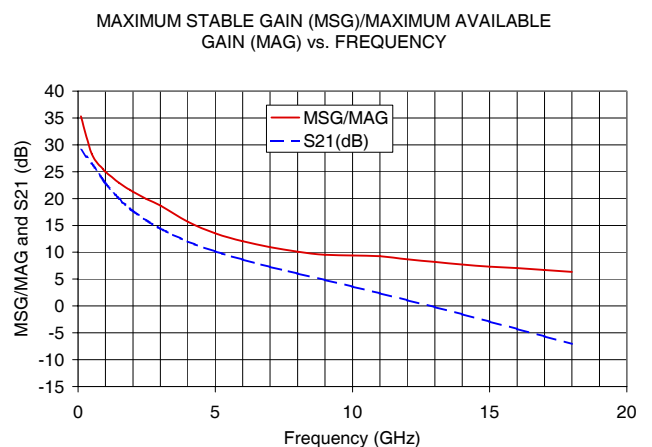



ULTRA LOW NOISE, HIGH CURRENT

E-PHEMT Transistor

TAV-541+

RECOMMENDED APPLICATION CIRCUIT

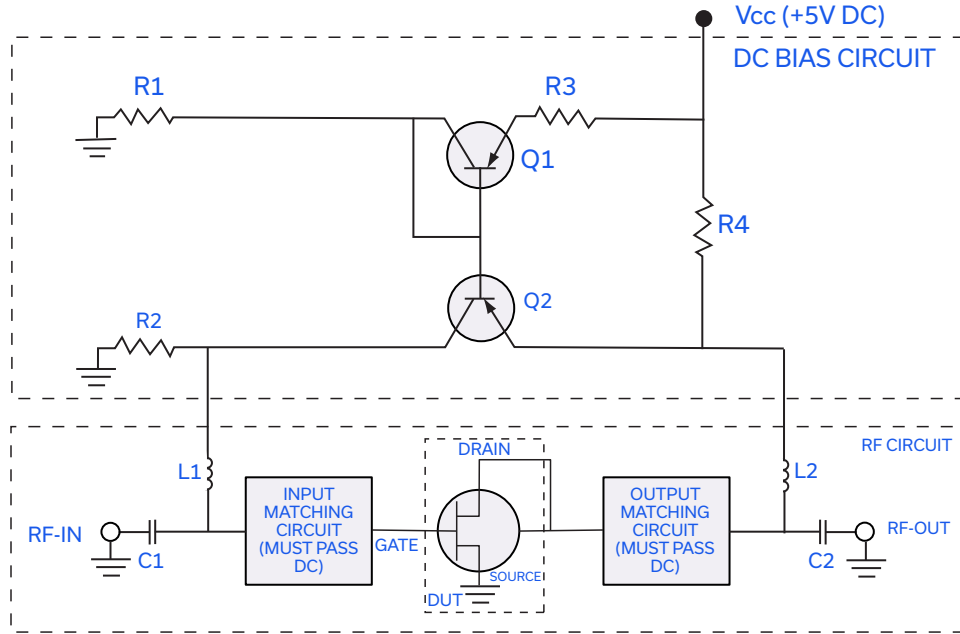

VDS, V (nom)	3	4
IDS, mA (nom)	60mA	60mA
R1	4320Ω	4320Ω
R2	4320Ω	4320Ω
R3	3570Ω	1210Ω
R4	33.2Ω	16.7Ω
Q1	MMBT3906*	MMBT3906*
Q2	MMBT3906*	MMBT3906*
C1	0.01μF	0.01μF
C2	0.01μF	0.01μF
L1**	840nH	840nH
L2**	840nH	840nH

* Fairchild Semiconductor™ part number
 ** Piconics™ part number CC45T47K240G5

OPTIMIZED AMPLIFIER CIRCUITS

For band specific, drop-in modules, and as an alternative to designing circuits, please refer to Mini-Circuits TAMP and RAMP series models which are based upon SAV/TAV E-PHEMT's and include all DC blocking, bias, matching and stabilization circuitry, without need for any external components.

PRODUCT MARKING



Marking may contain other features or characters for internal lot control





ULTRA LOW NOISE, HIGH CURRENT

E-PHEMT Transistor

TAV-541+

Mini-Circuits

ADDITIONAL DETAILED TECHNICAL INFORMATION IS AVAILABLE ON OUR DASH BOARD. TO ACCESS [CLICK HERE](#)

Performance Data	Data Table Swept Graphs S-Parameter (S2P Files) Data Set (.zip file)
Case Style	FG873 Plastic low profile 3mm x 3mm, lead finish: tin/silver/nickel
Tape & Reel Standard quantities available on reel	F68 7" reels with 20, 50, 100, 200, 500,1K,2K or 3K devices
Suggested Layout for PCB Design	PL-301
Evaluation Board	TB-154+
Environmental Ratings	ENV08T2

ESD RATING

Human Body Model (HBM): Class 1A (250 V to < 500 V) in accordance with ANSI/ESD STM 5.1 - 2001

Machine Model (MM): Class M1 (40 V) in accordance with ANSI/ESD STM 5.2 - 1999

MSL RATING

Moisture Sensitivity: MSL1 in accordance with IPC/JEDECJ-STD-020D

MSL TEST FLOW CHART

