

TENTATIVETOSHIBA Bi-CMOS INTEGRATED CIRCUIT
SILICON MONOLITHIC

TB1227CNG

VIDEO, CHROMA AND SYNCHRONIZING SIGNALS PROCESSING IC FOR PAL / NTSC / SECAM SYSTEM COLOR TV

TB1227CNG that is a signal processing IC for the PAL / NTSC / SECAM color TV system integrates video, chroma and synchronizing signal processing circuits together in a 56-pin shrink DIP plastic package.

TB1227CNG incorporates a high performance picture quality compensation circuit in the video section, an automatic PAL / NTSC / SECAM discrimination circuit in the chroma section, and an automatic 50 / 60Hz discrimination circuit in the synchronizing section. Besides a crystal oscillator that internally generates 4.43MHz, 3.58MHz and M / N-PAL clock signals for color demodulation, there is a horizontal PLL circuit built in the IC.

The PAL / SECAM demodulation circuit which is an adjustment-free circuit incorporates a 1H DL circuit inside for operating the base band signal processing system.

Also, TB1227CNG makes it possible to set or control various functions through the built-in I²C bus line.

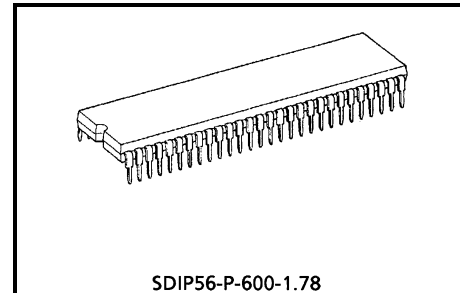

Weight: 5.55 g (typ.)

FEATURES

Video section

- Built-in trap filter
- Black expansion circuit
- Variable DC regeneration rate
- Y delay line
- Sharpness control by aperture control
- γ correction
- VSM output

Chroma section

- Built-in 1H Delay circuit
- PAL / SECAM base band demodulation system
- One crystal color demodulation circuit (4.43MHz, 3.58MHz, M / N-PAL)
- Automatic system discrimination, system forced mode
- 1H delay line also serves as comb filter in NTSC demodulation
- Built-in band-pass filter, SECAM bell filter
- Color limiter circuit
- Fsc output

Synchronizing deflecting section

- Built-in horizontal VCO resonator
- Adjustment-free horizontal / vertical oscillation by count-down circuit
- Double AFC circuit
- Vertical frequency automatic discrimination circuit
- Horizontal / vertical holding adjustment
- Vertical ramp output
- Vertical amplitude adjustment
- Vertical linearity / S-shaped curve adjustment

- SCP (Sand Castle Pulse) output

Text section

- Linear RGB input
- OSD RGB input
- Cut / off-drive adjustment
- RGB primary signal output

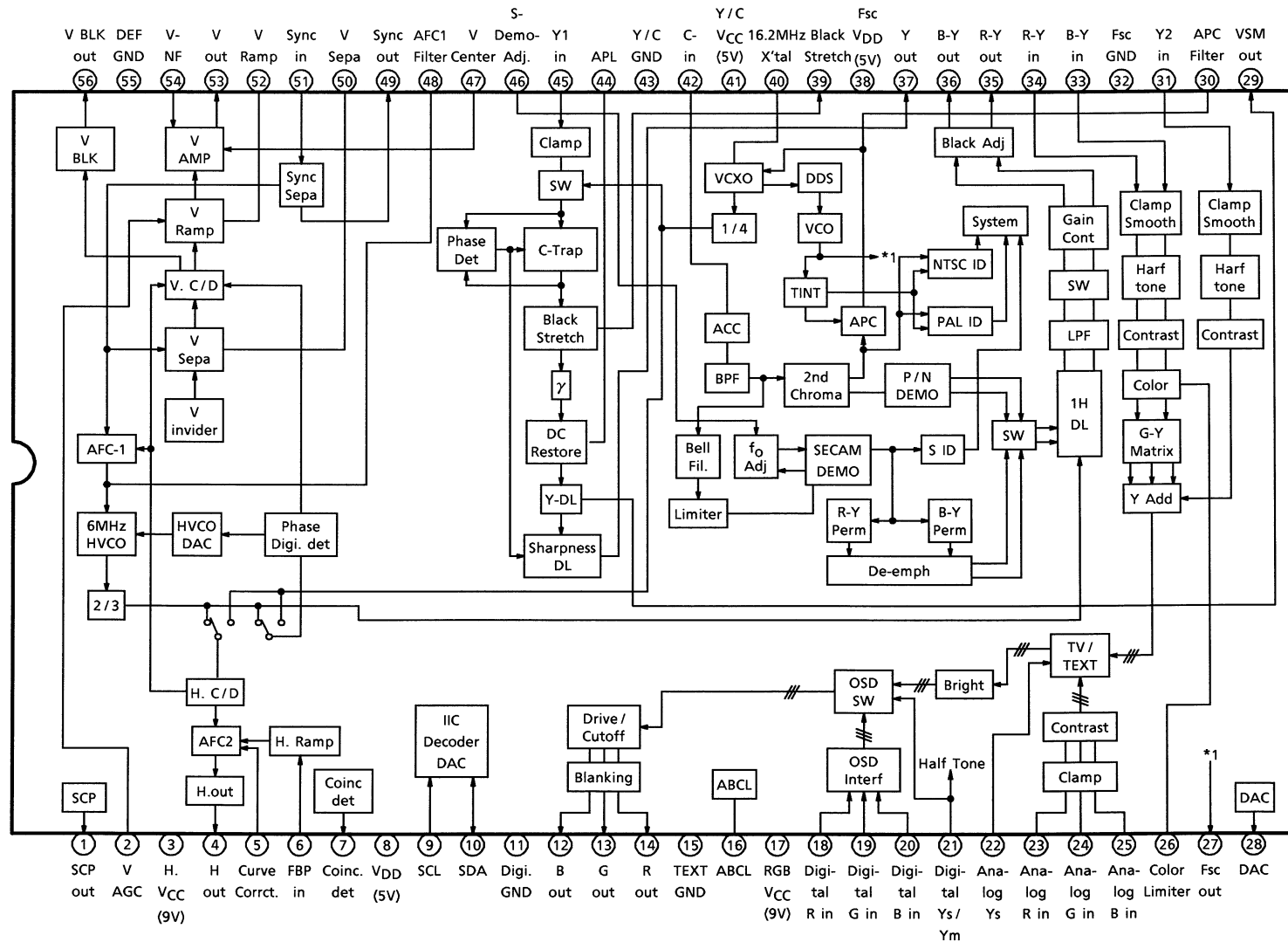

BLOCK DIAGRAM

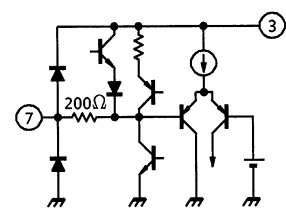
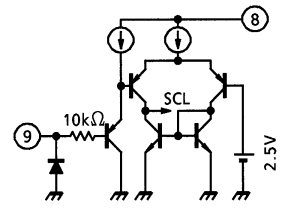
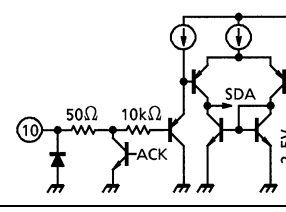
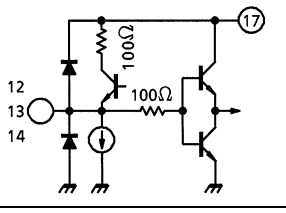
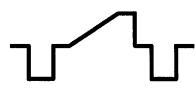
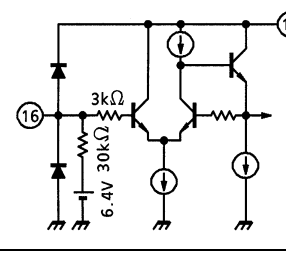

TERMINAL FUNCTIONS

PIN No.	PIN NAME	FUNCTION	INTERFACE CIRCUIT	INPUT / OUTPUT SIGNAL
1	SCP OUTPUT	Output terminal of Sand Castle Pulse. (SCP) To connect drive resistor for SCP.		
2	V-AGC	Controls pin 52 to maintain a uniform V-ramp output. Connect a current smoothing capacitor to this pin.		—
3	H-V _{CC} (9V)	V _{CC} for the DEF block (deflecting system). Connect 9V (Typ.) to this pin.	—	—
4	Horizontal Output	Horizontal output terminal.		
5	Picture Distortion Correction	Corrects picture distortion in high voltage variation. Input AC component of high voltage variation. For inactivating the picture distortion correction function, connect 0.01μF capacitor between this pin and GND.		4.5V at Open
6	FBP Input	FBP input for generating horizontal AFC2 detection pulse and horizontal blanking pulse. The threshold of horizontal AFC2 detection is set $H.V_{CC} - 2V_f$ ($V_f \approx 0.75V$). Confirming the power supply voltage, determine the high level of FBP.		

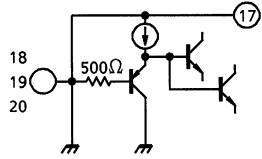
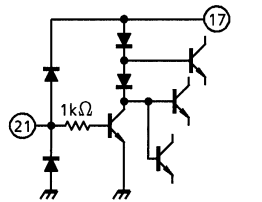
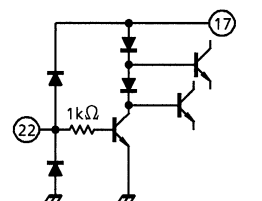
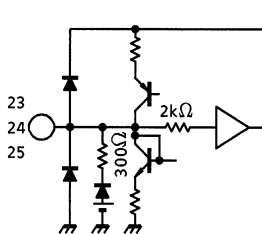
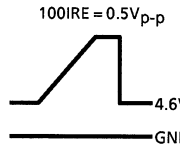
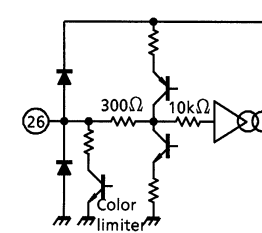
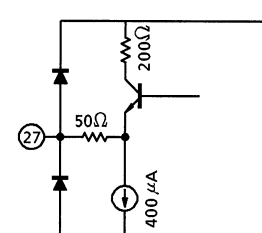
PIN No.	PIN NAME	FUNCTION	INTERFACE CIRCUIT	INPUT / OUTPUT SIGNAL
7	Coincident Det.	To connect filter for detecting presence of H. synchronizing signal or V. synchronizing signal.		—
8	V _{DD} (5V)	V _{DD} terminal of the LOGIC block. Connect 5V (Typ.) to this pin.	—	—
9	SCL	SCL terminal of I ² C bus.		—
10	SDA	SDA terminal of I ² C bus.		—
11	Digital GND	Grounding terminal of LOGIC block.	—	—
12 13 14	B Output G Output R Output	R, G, B output terminals.		
15	TEXT GND	Grounding terminal of TEXT block.	—	—
16	ABCL	External unicolor brightness control terminal. Sensitivity and start point of ABL can be set through the bus.		6.4V at Open
17	RGB-V _{CC} (9V)	V _{CC} terminal of TEXT block. Connect 9V (Typ.) to this pin.	—	—

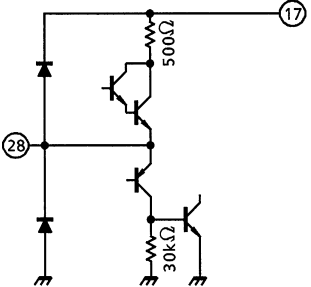
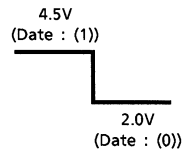
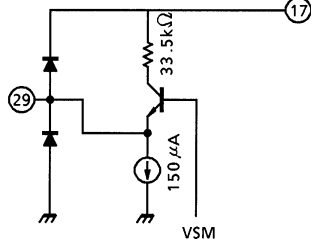
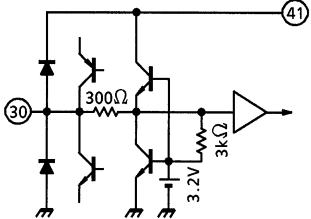
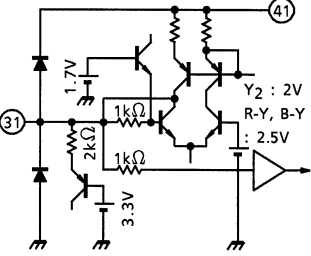
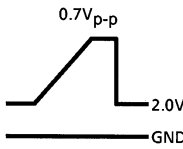
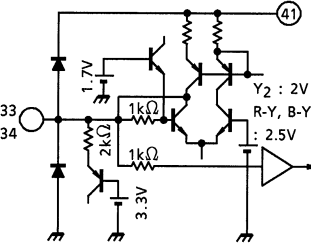

PIN No.	PIN NAME	FUNCTION	INTERFACE CIRCUIT	INPUT / OUTPUT SIGNAL
18 19 20	Digital R Input Digital G Input Digital B Input	Input terminals of digital R, G, B signals. Input DC directly to these pins. OSD or TEXT signal can be input to these pins.		OSD — 3.0V TEXT — 2.0V — GND
21	Digital YS / YM	Selector switch of halftone / internal RGB signal / digital RGB (pins 18, 19, 20).		OSD — 3.0V TEXT — 2.0V H.T. — 1.0V TV — GND
22	Analog YS	Selector switch of internal RGB signal or analog RGB (pins 23, 24, 25).		Analog RGB — 0.5V TV — GND
23 24 25	Analog R Input Analog G Input Analog B Input	Analog R, G, B input terminals. Input signal through the clamping capacitor. Standard input level : 0.5V _{p-p} (100 IRE).		100IRE = 0.5V _{p-p}  — 4.6V — GND
26	Color Limiter	To connect filter for detecting color limit.		—
27	FSC Output	Output terminal of FSC.		3.58MHz  Other 500mV _{p-p}

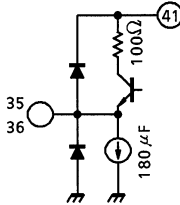
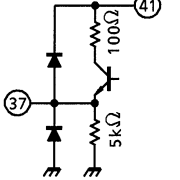
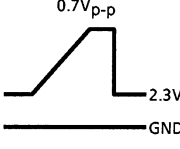
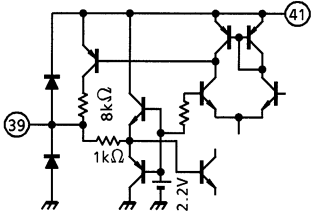
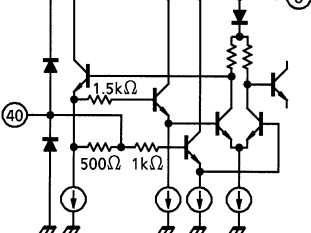
PIN No.	PIN NAME	FUNCTION	INTERFACE CIRCUIT	INPUT / OUTPUT SIGNAL
28	1Bit DAC Output Terminal	Enable to change slave address to 8Ah by a connecting V _{CC} with this terminal.		
29	VSM Output Terminal	Power output the signal that is primary differentiated Y signal. Enable to change output amplifier and phase by the Bus.		—
30	APC Filter	To connect APC filter for chroma demodulation.		DC 3.2V
31	Y ₂ Input	Input terminal of processed Y signal. Input Y signal through clamping capacitor. Standard input level : 0.7V _{p-p}		
32	Fsc GND	Grounding terminal of VCXO block. Insert a decoupling capacitor between this pin and pin 38 (Fsc V _{DD}) at the shortest distance from both.	—	—
33 34	B-Y Input R-Y Input	Input terminal of B-Y or R-Y signal. Input signal through a clamping capacitor.		DC 2.5V AC B-Y : 650mV _{p-p} R-Y : 510mV _{p-p} (with input of PAL-75% color bar signal)

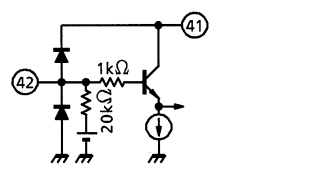
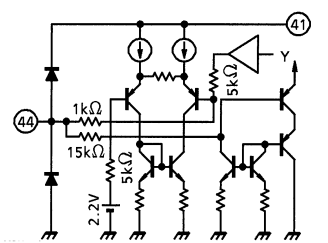
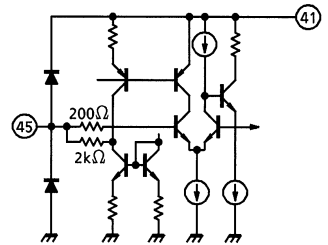
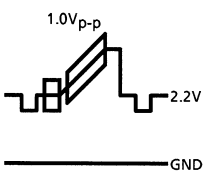
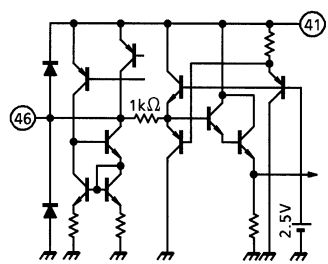
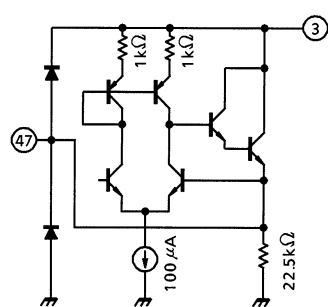
PIN No.	PIN NAME	FUNCTION	INTERFACE CIRCUIT	INPUT / OUTPUT SIGNAL
35 36	R-Y Output B-Y Output	Output terminal of demodulated R-Y or B-Y signal. There is an LPF for removing carrier built in this pin.		DC 1.9V AC B-Y : 650mV _{p-p} R-Y : 510mV _{p-p} (with input of PAL-75% color bar signal)
37	Y Output	Output terminal of processed Y signal. Standard output level : 0.7V _{p-p}		
38	Fsc V _{DD}	V _{DD} terminal of DDS block. Insert a decoupling capacitor between this pin and pin 32 (Fsc GND) at the shortest distance from both. If decoupling capacitor is inserted at a distance from the pins, it may cause spurious deterioration.	—	—
39	Black Stretch	To connect filter for controlling black expansion gain of the black expansion circuit. Black expansion gain is determined by voltage of this pin.		DC 1.6V
40	16.2MHz X'tal	To connect 16.2MHz crystal clock for generating sub-carrier. Lowest resonance frequency (f_0) of the crystal oscillation can be varied by changing DC capacity. Adjust f_0 of the oscillation frequency with the board pattern.		DC 4.1V

PIN No.	PIN NAME	FUNCTION	INTERFACE CIRCUIT	INPUT / OUTPUT SIGNAL
41	Y / C V _{CC} (5V)	V _{CC} terminal of Y / C signal processing block.	—	—
42	Chroma Input	Chroma signal input terminal. Input negative 1.0V _{p-p} sync composite video signal to this pin through a coupling capacitor.		DC 2.4V AC : 300mV _{p-p} burst
43	Y / C GND	Grounding terminal of Y / C signal processing block.	—	—
44	APL	To connect filter for DC regeneration compensation. Y signal after black expansion can be monitored by opening this pin.		DC 2.2V
45	Y ₁ Input	Input terminal of Y signal. Input negative 1.0V _{p-p} sync composite video signal to this pin through a clamping capacitor.		
46	S-Demo-Adj.	To connect f ₀ adjustment filter for SECAM demodulation.		DC 3.2V
47	V-Center	DC Output Terminal For V Centering. Enable to control output DC voltage by the bus.		DC 2.7~6.3V

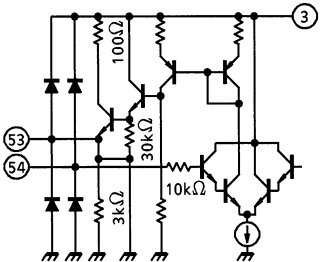
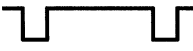
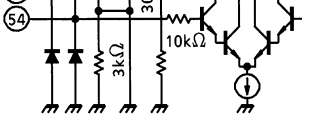
PIN No.	PIN NAME	FUNCTION	INTERFACE CIRCUIT	INPUT / OUTPUT SIGNAL
48	AFC1 Filter	To connect filter for horizontal AFC1 detection. Horizontal frequency is determined by voltage of this pin.		DC 5.0V
49	Sync Output	Output terminal of synchronizing signal separated by sync separator circuit. Connect a pull-up resistor to this pin because it is an open-collector output type.		
50	V-Sepa.	To connect filter for vertical synchronizing separation.		DC 5.9V
51	Sync Input	Input terminal of synchronizing separator circuit. Input signal through a clamping capacitor to this pin. Negative 1.0V _{p-p} sync.		
52	V-Ramp	To connect filter for generating V-ramp waveform.		

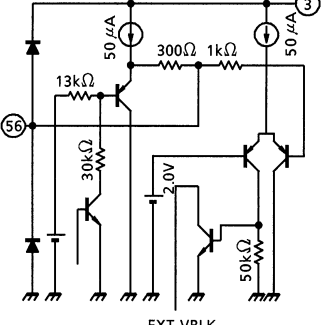
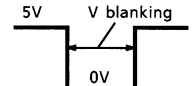
PIN No.	PIN NAME	FUNCTION	INTERFACE CIRCUIT	INPUT / OUTPUT SIGNAL
53	Vertical Output	Output terminal of vertical ramp signal.		
54	V-NF	Input terminal of vertical NF signal.		
55	DEF GND	Grounding terminal of DEF (deflection) block.	—	—
56	V BLK Output	Output terminal of V blanking.		

BUS CONTROL MAP

WRITE DATA

Slave address : 88H (Pin28-High : 8AH)

BLOCK	SUB ADDR	MSB 7	6	5	4	3	2	1	LSB 0	PRESET			
VIDEO / TEXT	00	Uni-Color								1 0 0 0	0 0 0 0		
	01	BRIGHT								1 0 0 0	0 0 0 0		
	02	COLOR								1 0 0 0	0 0 0 0		
	03	*	TINT								0 1 0 0	0 0 0 0	
	04	P / N KIL	0	SHARPNESS								0 0 1 0	0 0 0 0
	05	DTrp-SW	R-Mon	B-Mon	Y SUB CONTRAST						1 0 0 1	0 0 0 0	
	06	RGB-CONTRAST								1 0 0 0	0 0 0 0		
—	07	*	*	*	*	*	*	*	*	1 0 0 0	0 0 0 0		
VIDEO / TEXT	08	Y _γ	WPL SW	0	BLUE BACK MODE			Y-DL SW			0 0 0 0	0 1 0 0	
	09	G DRIVE GAIN								1 0 0 0	0 0 0 0		
	0A	B DRIVE GAIN								1 0 0 0	0 0 0 0		
DEF	0B	HORIZONTAL POSITION				AFC MODE			H-CK SW	1 0 0 0	0 0 0 1		
TEXT (P / N)	0C	R CUT OFF								0 0 0 0	0 0 0 0		
	0D	G CUT OFF								0 0 0 0	0 0 0 0		
	0E	B CUT OFF								0 0 0 0	0 0 0 0		
	0F	B. S. OFF	C-TRAP	OFST SW	C-TOF	P / N GP	CLL SW	WBLK SW	WMUT SW	0 0 0 0	0 0 0 0		
SYSTEM	10	S-INHBT	358 Trap	F-B / W	X'tal MODE			COLOR SYSTEM			0 0 0 0	0 0 0 0	
	11	R-Y BLACK OFFSET				B-Y BLACK OFFSET				1 0 0 0	1 0 0 0		
P / N	12	CLL LEVEL		PN CD ATT		TOF Q		TOF FO		1 0 0 1	1 0 1 0		
Vi / C	13	V-MODE	VSM PHASE	VSM GAIN		C-TRAP Q		C-TRAP FO		1 0 1 1	1 0 1 0		
VIDEO (DEF)	14	BLACK STRETCH POINT			DC TRAN RATE			APA-CON FO / SW			1 0 0 0	0 0 1 0	
	15	ABL POINT			ABL GAIN			HALF TONE SW			0 0 0 0	0 0 0 0	
GEOMETRY	16	H BLK PHASE			V FREQ		V OUT PHASE				0 0 0 0	0 0 0 0	
	17	V-AMPLITUDE							*	1 0 0 0	0 0 0 0		
	18	V CENTERING					COINCIDENT DET				1 0 0 0	0 0 1 0	
	19	V S-CORRECTION							DRG SW		1 0 0 0	0 0 0 0	
	1A	V LINEARITY				V-CD MD	DRV CNT	VAGC SP		0 0 0 0	0 0 0 1		
DEF-V	1B	MUTE MODE			WIDE V-BLK START PHASE						0 1 1 1	1 1 1 1	
	1C	BLK SW	WIDE V-BLK STOP PHASE						0 0 0 0	0 0 0 0			
	1D	NOISE DET LEVEL			WIDE P-MUTE START PHASE						1 0 1 1	1 1 1 1	
	1E	N COMB	WIDE P-MUTE STOP PHASE						0 0 0 0	0 0 0 0			
SECAM	1F	S-field	SCD ATT	DEMP FO	S GP	V-ID SW	S KIL	BELL FO		0 0 0 0	0 0 0 1		

Note: * : Data is ignored.

READ-IN DATA

Slave address : 89H (Pin28-High : 8BH)

	MSB 7	6	5	4	3	2	1	LSB 0
00	PORES	COLOR SYSTEM		X'tal		V-FREQ	V-STD	N-DET
01	LOCK	RGBOUT	Y ₁ -IN	UV-IN	Y ₂ -IN	H	V	V-GUARD

BUS CONTROL FUNCTION WRITE FUNCTION

ITEM	DESCRIPTION	NUMBER OF BITS	VARIABLE RANGE	PRESET VALUE
UNI-COLOR	—	8bit	-18dB~0dB	80h MAX-5.0dB
BRIGHT	—	8bit	-1V~1V	80h 0V
COLOR	—	8bit	~0dB	80h -6dB
TINT	—	7bit	-45°~45°	40h 0°
P / N KIL	P / N KILLER sensitivity control	1bit	Normal / Low	00h NORMAL
SHARPNESS	—	6bit	-6dB~12dB	20h +3dB
DTrp-SW	SECAM double trap ON / OFF	1bit	ON / OFF	01h OFF
R-Mon	TEXT-11 dB pre-amplification UV output	1bit	Normal / Monitor	00h Normal
B-Mon	(Pin 35 : Bo, Pin 36 : Ro)	1bit	Normal / Monitor	00h Normal
Y SUB CONTRAST	—	5bit	-3dB~+3dB	10h 0dB
RGB-CONTRAST	EXT RGB UNI-COLOR control	8bit	-18dB~0dB	80h MAX - 5.0dB
Y _γ	γ ON / OFF	1bit	OFF / 95 IRE	00h ON
WPL SW	White peak limit level	1bit	130 IRE / OFF	00h 130 IRE
BLUE BACK MODE	Luminance selector switch	2bit	IRE ; OFF, 40, 50, 50	00h OFF
Y-DL SW	Y-DL TIME (28, 33, 38, 43, 48)	3bit	280~480ns after Y IN	04h 480ns
G DRIVE GAIN	—	8bit	-5dB~3dB	80h 0dB
B DRIVE GAIN	—	8bit	-5dB~3dB	80h 0dB
HORIZONTAL POSITION	Horizontal position adjustment	5bit	-3μs~+3μs	10h 0μs

ITEM	DESCRIPTION	NUMBER OF BITS	VARIABLE RANGE	PRESET VALUE
AFC MODE	AFC1 detection sensitivity selector	2bit	dB ; AUTO, 0, -10, -10	00h AUTO
H-CK SW	HOUT generation clock selector	1bit	384fh-VCO, FSC-VCXO	01h FSC-VCXO
R CUT OFF	—	8bit	-0.5~0.5V	00h -0.5V
G CUT OFF	—	8bit	-0.5~0.5V	00h -0.5V
B CUT OFF	—	8bit	-0.5~0.5V	00h -0.5V
B. S. OFF	Black expansion ON / OFF	1bit	ON / OFF	00h ON
C-TRAP	Chroma Trap ON / OFF SW	1bit	ON / OFF	00h ON
FST SW	Black offset SECAM discrimination interlocking switch	1bit	SECAM only / All systems	00h S only
C-TOF	P / N TOF ON / OFF SW	1bit	ON / OFF	00h ON
P / N GP	PAL GATE position	1bit	Standard / 0.5μs delay	00h Standard
CL-L SW	COLOR LIMIT ON / OFF	1bit	ON / OFF	00h ON
WBLK SW	WIDE V-BLK ON / OFF	1bit	OFF / ON	00h OFF
WMUT SW	WIDE Picture-MUTE ON / OFF	1bit	OFF / ON	00h OFF
S-INHBT	To detect or not to detect SECAM	1bit	Yes / No	00h Yes
3.58 Trap	C Trap-f ₀ , force 3.58MHz switch	1bit	AUTO / Forced 3.58MHz	00h AUTO
F-B / W	Force B / W switch	1bit	AUTO / Forced B / W	00h AUTO
X'tal MODE	APC oscillation frequency selector switch	3bit	000 ; European system AUTO, 001 ; 3N 010 ; 4P 011 ; 4P (N inhibited) 100 ; S.American system AUTO 101 ; 3N 110 ; MP 111 ; NP	00h European system AUTO
COLOR SYSTEM	Chroma system selection	2bit	AUTO, PAL, NTSC, SECAM	00h AUTO
R-Y BLACK OFFSET	R-Y color difference output black offset adjustment	4bit	-24~21mV STEP 3mV	08h 0mV
B-Y BLACK OFFSET	B-Y color difference output black offset adjustment	4bit	-24~21mV STEP 3mV	08h 0mV
CLL LEVEL	Color limit level adjustment	2bit	91, 100, 108, 116%	02h 108%

Note: 3N; 3.58-NTSC, 4P; 4.43-PAL, MP ; M-PAL, NP; N-PAL
 European system AUTO; 4.43-PAL, 4.43-NSTC, 3.58-NTSC, SRCAM
 S. American system AUTO; 3.58-NTSC, M-PAL, N-PAL

ITEM	DESCRIPTION	NUMBER OF BITS	VARIABLE RANGE	PRESET VALUE
PN CD ATT	P / N color difference amplitude adjustment	2bit	+1~-2dB STEP 1dB	01h 0dB
TOF Q	TOF Q adjustment	2bit	1.0, 1.5, 2.0, 2.5	02h 2.0
TOF F ₀	TOF f ₀ adjustment	2bit	kHz ; 0, 500, 600, 700	02h 600kHz
VSM PHASE	VSM output phase	2bit	+20ns, +20ns, 0ns, 0ns	02h 0ns
VSM GAIN	VSM output gain	2bit	0dB, 0dB, -6dB, OFF	03h OFF
C-TRAP Q	Chroma trap Q control	2bit	1.0, 1.5, 2.0, 2.5	02h 2.0
C-TRAP F ₀	Chroma trap f ₀ control	2bit	kHz ; -100, -50, 0, +50	02h 0kHz
BLACK STRETCH POI	Black expansion start point setting	3bit	28~70% IRE×0.4	05h 56% IRE
DC TRAN RATE	Direct transmission compensation degree selection	3bit	100~130% APL	00h 100%
APA-CON PEAK F ₀	Sharpness peak frequency selection	2bit	kHz ; 2.5, 3.1, 4.2, OFF	02h 4.2kHz
ABL POINT	ABL detection voltage	3bit	ABL point ; 6.5V~5.9V	00h 6.5V
ABL GAIN	ABL sensitivity	3bit	Brightness ; 0~-2V	00h 0V
HALF TONE SW	Halftone gain selection	2bit	-3dB, -6dB, OFF, OFF	00h -3dB
H BLK PHASE	Horizontal blanking end position	3bit	0~3.5μs step 0.5μs	00h 0μs
V FREQ	Vertical frequency	2bit	AUTO, 60Hz, Forced 60, 50, 60	00h AUTO
V OUT PHASE	Vertical position adjustment	3bit	0~7H STEP 1H	00h 0H
V-AMPLITUDE	Vertical amplitude selection	7bit	-50~50%	40h 0%
1bit DAC	1bit DAC output	1bit	LOW, HIGH	00h LOW
V CENTERING	V Centering	6bit	1~4V	20h 2.5V
COINCIDENT MODE	Discriminator output signal selection	2bit	00 ; DSYNC 01 ; DSYNC×AFC 10 ; Field counting 11 ; VP is present.	02h Field counting
V S-CORRECTION	Vertical S-curve correction	7bit	Reverse S-curve, S-curve	40h —
V-MODE	Force Sync Mode Selection	1bit	TELETEXT / Normal	01h Normal
DRG SW	Drive reference axis selection	1bit	R / G	00h R
V LINEARITY	Vertical linearity correction	5bit	(one side)	00h —
ND SW	Noise Det SW	1bit	Normal, Low	00h Normal
V-CD MD	Vertical count-down mode selection	1bit	AUTO / Force synchronization	00h AUTO

ITEM	DESCRIPTION	NUMBER OF BITS	VARIABLE RANGE	PRESET VALUE
DRV CNT	All drive gains forced centering switch	1bit	OFF / Force centering	00h OFF
VAGC SP	Vertical ramp time constant selection	1bit	Normal / High speed	01h High speed
MUTE MODE	OFF, RGB mute, Y mute, transverse	2bit	OFF, RGB, Y, Transverse	01h RGB
WIDE V-BLK START PH	Vertical pre-position selection	6bit	-64~-1H STEP 1H	3Fh -1H
BLK SW	Blanking ON / OFF	1bit	ON / OFF	00h ON
WIDE V-BLK STOP PH	Vertical post-position selection	7bit	0~128H STEP 1H	00h 0H
NOISE DET LEVEL	Noise detection level selection	2bit	0.20, 0.15, 0.10, 0.05	02h 0.1
WIDE P-MUTE START PH	Video mute pre-position selection	6bit	-64~-1H STEP 1H	3Fh -1H
N COMB	1H addition selection	1bit	OFF / ADD	00h OFF
WIDE P-MUTE STOP PH	Video mute post-position selection	7bit	0~128H STEP 1H	00h 0H
S-field	SECAM color and Q selection in weak electric field	1bit	Weak electric field control ON / OFF	00h ON
SCD ATT	SECAM color difference amplitude adjustment	1bit	0 / -1dB	00h 0dB
DEMO F ₀	SECAM deemphasis time constant selection	1bit	85kHz / 100kHz	00h 85kHz
S GP	SECAM gate position selection	1bit	Standard / 0.5μs delay	00h Standard
V-ID SW	SECAM V-ID ON / OFF switch	1bit	OFF / ON	00h OFF
S KIL	SECAM KILLER sensitivity selection	1bit	NORMAL / LOW	00h NORMAL
BELL F ₀	Bell f ₀ adjustment	2bit	-46~92kHz STEP 46kHz	01h 0kHz

READ-IN FUNCTION

ITEM	DESCRIPTION	NUMBER OF BITS
PONRES	0 : POR cancel, 1 : POR ON	1bit
COLOR SYSTEM	00 : B / W, 01 : PAL 10 : NTSC, 11 : SECAM	2bit
X'tal	00 : 4.433619MHz 01 : 3.579545MHz 10 : 3.575611MHz (M-PAL) 11 : 3.582056MHz (N-PAL)	2bit
V-FREQ	0 : 50Hz, 1 : 60Hz	1bit
V-STD	0 : NON-STD, 1 : STD	1bit
N-DET	0 : Low, 1 : High	1bit
LOCK	0 : UN-LOCK, 1 : LOCK	1bit
RGBOUT, Y ₁ -IN UV-IN, Y ₂ -IN, H, V	Self-diagnosis 0 : NG, 1 : OK	1bit each
V-GUARD	Detection of breaking neck 0 : Abnormal, 1 : Normal	1bit

DATA TRANSFER FORMAT VIA I²C BUS

Start and stop condition

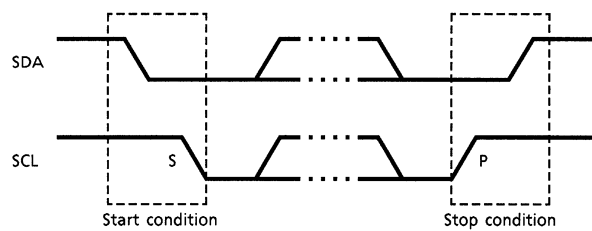

Bit transfer

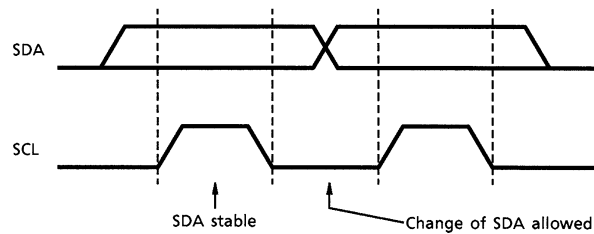

Acknowledge

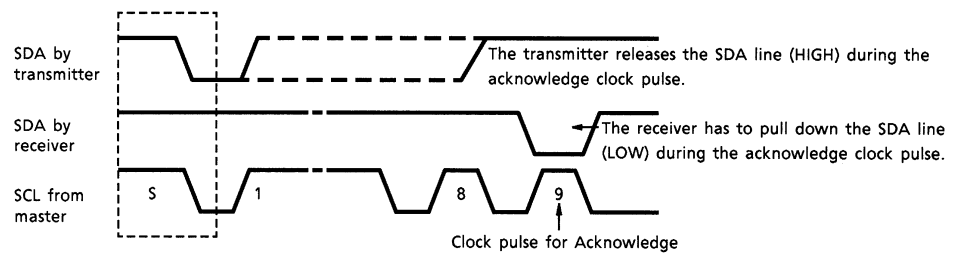

Data transmit format 1

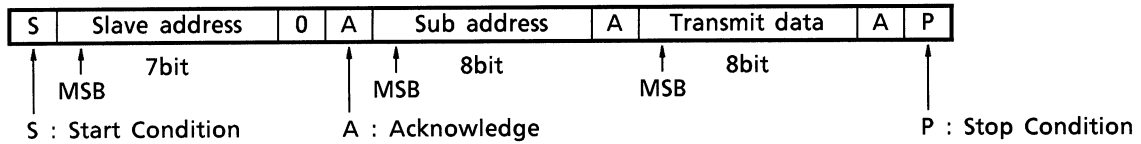

Data transmit format 2

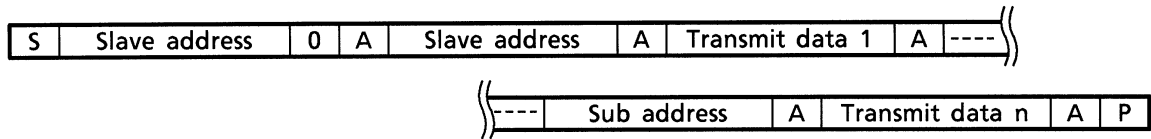

Data receive format

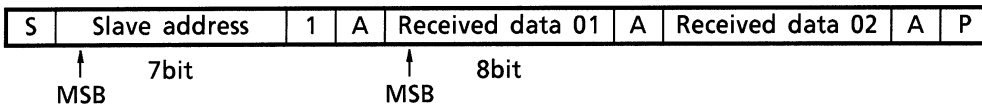

At the moment of the first acknowledge, the master transmitter becomes a master receiver and the slave receiver becomes a slave transmitter. This acknowledge is still generated by the slave.

The STOP condition is generated by the master.

Optional data transmit format : Automatic increment mode

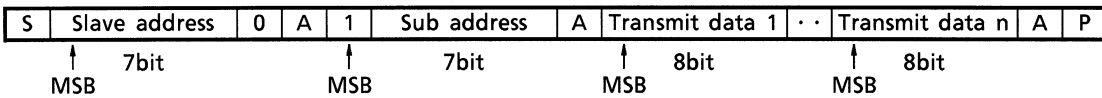

In this transmission method, data is set on automatically incremented sub-address from the specified sub-address.

Purchase of TOSHIBA I²C components conveys a license under the Philips I²C Patent Rights to use these components in an I²C system, provided that the system conforms to the I²C Standard Specification as defined by Philips.

MAXIMUM RATINGS (Ta = 25°C)

CHARACTERISTIC	SYMBOL	RATING	UNIT
Supply Voltage	V _{CCMAX}	12	V
Permissible Loss	P _{DMAX}	2190 (Note)	mW
Power Consumption Declining Degree	1 / Q _{ja}	17.52	mW / °C
Input Terminal Voltage	V _{in}	GND - 0.3~V _{CC} + 0.3	V
Input Signal Voltage	e _{in}	7	V _{p-p}
Operating Temperature	T _{opr}	-20~65	°C
Conserving Temperature	T _{stg}	-55~150	°C

Note: In the condition that IC is actually mounted. See the diagram below.

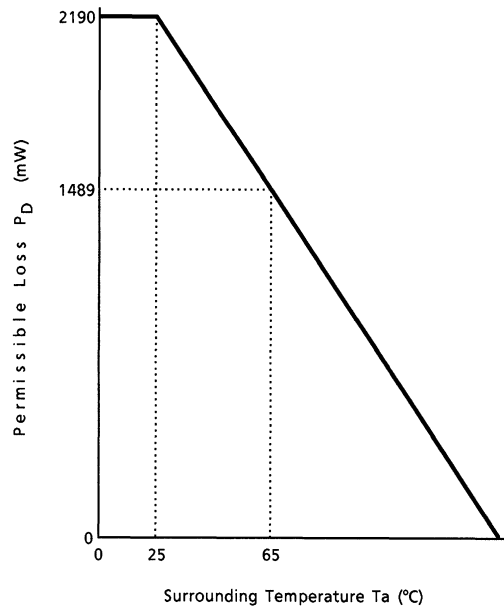

Fig. Power consumption declining curve relative to temperature change

OPERATING CONDITIONS

CHARACTERISTIC	DESCRIPTION	MIN	TYP.	MAX	UNIT
Supply Voltage	Pin 3, pin 17	8.50	9.0	9.25	V
	Pin 8, pin 38, pin 41	4.75	5.0	5.25	
Video Input Level	100% white, negative sync	0.9	1.0	1.1	V _{p-p}
Chroma Input Level		0.9	1.0	1.1	
Sync Input Level		0.9	1.0	2.2	
FBP Width	—	11	12	13	μs
Incoming FBP Current (Note)	—	—	—	1.5	mA
H. Output Current	—	—	1.0	2.0	
RGB Output Current	—	—	1.0	2.0	V
Analog RGB Input Level	—	—	0.7	0.8	
OSD RGB Input Level	In TEXT input	0.7	1.0	1.3	
	In OSD input	—	4.2	5.0	
Incoming Current to Pin 49	Sync-out	—	0.5	1.0	mA

Note: The threshold of horizontal AFC2 detection is set $H.V_{CC}-2V_f$ ($V_f \approx 0.75V$).
 Confirming the power supply voltage, determine the high level of FBP.

ELECTRICAL CHARACTERISTIC

(Unless otherwise specified, H, RGB $V_{CC} = 9V$, V_{DD} , Fsc V_{DD} , Y / C $V_{CC} = 5V$, $T_a = 25^\circ C$)

CURRENT CONSUMPTION

PIN No.	CHARACTERISTIC	SYMBOL	TEST CIR-CUIT	MIN	TYP.	MAX	UNIT
3	H. V_{CC} (9V)	I_{CC1}	—	16.0	19.0	23.5	mA
8	V_{DD} (5V)	I_{CC2}	—	8.8	11.0	14.0	
17	RGB V_{CC} (9V)	I_{CC3}	—	25.0	31.5	39.0	
38	Fsc V_{CC} (5V)	I_{CC4}	—	6.8	8.5	11.0	
41	Y / C V_{CC} (9V)	I_{CC5}	—	80	100	130	

TERMINAL VOLTAGE

PIN No.	PIN NAME	SYMBOL	TEST CIR-CUIT	MIN	TYP.	MAX	UNIT
16	ABCL	V ₁₆	—	5.9	6.4	6.9	V
18	OSD R Input	V ₁₈	—	—	0	0.3	V
19	OSD G Input	V ₁₉	—	—	0	0.3	V
20	OSD B Input	V ₂₀	—	—	0	0.3	V
21	Digital Ys	V ₂₁	—	—	0	0.3	V
22	Analog Ys	V ₂₂	—	—	0	0.3	V
23	Analog R Input	V ₂₃	—	4.2	4.6	5.0	V
24	Analog G Input	V ₂₄	—	4.2	4.6	5.0	V
25	Analog B Input	V ₂₅	—	4.2	4.6	5.0	V
28	DAC	V ₂₈	—	1.7	2.0	2.3	V
31	Y ₂ Input	V ₃₁	—	1.7	2.0	2.3	V
33	B-Y Input	V ₃₃	—	2.2	2.5	2.8	V
34	R-Y Input	V ₃₄	—	2.2	2.5	2.8	V
35	R-Y Output	V ₃₅	—	1.5	1.9	2.3	V
36	B-Y Output	V ₃₆	—	1.5	1.9	2.3	V
37	Y ₁ Output	V ₃₇	—	1.9	2.3	2.7	V
40	16.2MHz X'tal Oscillation	V ₄₀	—	3.6	4.1	4.6	V
42	Chroma Input	V ₄₂	—	2.0	2.4	2.8	V
50	V-Sepa.	V ₅₀	—	5.4	5.9	6.4	V

AC CHARACTERISTIC
Video section

CHARACTERISTIC	SYMBOL	TEST CIR-CUIT	TEST CONDITION	MIN	TYP.	MAX	UNIT
Y Input Pedestal Clamping Voltage	VYclp	—	(Note Y ₁)	2.0	2.2	2.4	V
Chroma Trap Frequency	fr3	—	(Note Y ₂)	3.429	3.58	3.679	MHz
	fr4	—		4.203	4.43	4.633	
Chroma Trap Attenuation (3.58MHz) (4.43MHz) (SECAM)	Gtr3a	—	(Note Y ₃)	20	26	52	dB
	Gtr3f	—		(Note Y ₄)	20	26	
	Gtr4	—	(Note Y ₅)		18	26	
Yγ Correction Point	γp	—	(Note Y ₆)	90	95	99	—
Yγ Correction Curve	γc	—	(Note Y ₇)	-2.6	-2.0	-1.3	dB
APL Terminal Output Impedance	Zo44	—	(Note Y ₈)	15	20	25	kΩ
DC Transmission Compensation Amplifier Gain	Adrmax	—	(Note Y ₉)	0.11	0.13	0.15	times
	Adrcnt	—		0.44	0.06	0.08	
Maximum Gain of Black Expansion Amplifier	Ake	—	(Note Y ₁₀)	1.20	1.5	1.65	
Black Expansion Start Point	VBS9MX	—	(Note Y ₁₁)	65	77.5	80	IRE
	VBS9CT	—		55	62.5	70	
	VBS9MN	—		48	55.5	63	
	VBS2MX	—		35	42.5	50	
	VBS2CT	—		25	31.5	38	
	VBS2MN	—		19	25.5	32	
Black Peak Detection Period (Horizontal) (Vertical)	TbpH	—	(Note Y ₁₂)	15	16	17	μs
	TbpV	—		33	34	35	H
Picture Quality Control Peaking Frequency	fp25	—	(Note Y ₁₃)	1.5	2.5	3.4	MHz
	fp31	—		1.9	3.1	4.3	
	fp42	—		3.0	4.2	5.4	
Picture Quality Control Maximum Characteristic	GS25MX	—	(Note Y ₁₄)	12.0	14.5	17.0	dB
	GS31MX	—		12.0	14.5	17.0	
	GS42MX	—		10.6	13.5	16.4	
Picture Quality Control Minimum Characteristic	GS25MN	—	(Note Y ₁₅)	-22.0	-19.5	-17.0	
	GS31MN	—		-22.0	-19.5	-17.0	
	GS42MN	—		-19.5	-16.5	-13.5	
Picture Quality Control Center Characteristic	GS25CT	—	(Note Y ₁₆)	6.0	8.5	11.0	
	GS31CT	—		6.0	8.5	11.0	
	GS42CT	—		4.6	7.5	10.4	
Y Signal Gain	Gy	—	(Note Y ₁₇)	-1.0	0	1.6	
Y Signal Frequency Characteristic	Gfy	—	(Note Y ₁₈)	-6.5	0	1.0	
Y Signal Maximum Input Range	Vyd	—	(Note Y ₁₉)	0.9	1.2	1.5	V

Chroma section

CHARACTERISTIC	SYMBOL	TEST CIRCUIT	TEST CONDITION	MIN	TYP.	MAX	UNIT					
ACC Characteristic	$f_o = 3.58$	3N _e AT	(Note C ₁)	30	35	90	mV _{p-p}					
		3N _{F1} T		68	85	105						
		3N _A T		0.9	1.0	1.1	times					
		3N _e AE		18	35	—						
		3N _{F1} E		71	85	102						
		3N _A E		0.9	1.0	1.1						
	$f_o = 4.43$	4N _e AT		18	35	—	mV _{p-p}					
		4N _{F1} T		71	85	102						
		4N _A T		0.9	1.0	1.1	times					
		4N _e AE		18	35	—						
		4N _{F1} E		71	85	102						
		4N _A E		0.9	1.0	1.1						
Band Pass Filter Characteristic	$f_o = 3.58$	3Nf _o	3.43	3.579	3.73	MHz						
		3Nf _{o500}	3.93	4.079	4.23							
		3Nf _{o600}	4.03	4.179	4.33							
	$f_o = 4.43$	3Nf _{o700}	4.13	4.279	4.43							
		4Nf _o	4.28	4.433	4.58							
		4Nf _{o500}	4.78	4.933	4.58							
	4Nf _{o600}	4.88	5.033	5.18								
	4Nf _{o700}	4.98	5.133	5.28								
	Band Pass Filter, -3dB Band Characteristic	$f_o = 3.58$	f _o	(Note C ₃)	1.64		1.79	1.94				
f _{o500}												
f _{o600}												
f _{o700}												
$f_o = 4.43$		f _o	2.07		2.22	2.37						
		f _{o500}										
	f _{o600}											
	f _{o700}											
Band Pass Filter, Q Characteristic Check	$f_o = 3.58$	Q ₁	(Note C ₄)	—	3.58	—						
		Q _{1.5}					—	2.39	—			
		Q _{2.0}								1.64	1.79	1.94
		Q _{2.5}								—	1.43	—
	$f_o = 4.43$	Q ₁		—	4.43	—						
		Q _{1.5}		—	2.95	—						
		Q _{2.0}		2.07	2.22	2.37						
		Q _{2.5}		—	1.77	—						

CHARACTERISTIC	SYMBOL	TEST CIRCUIT	TEST CONDITION	MIN	TYP.	MAX	UNIT	
1 / 2 f _c Trap Characteristic	f _o = 3.58	f _o	(Note C ₅)	1.45	1.60	1.75	MHz	
		f _{o500}		1.70	1.85	2.00		
		f _{o600}		1.75	1.90	2.06		
		f _{o700}		1.80	1.95	2.10		
	f _o = 4.43	f _o		1.85	2.00	2.15		
		f _{o500}		2.00	2.15	2.30		
		f _{o600}		2.05	2.20	2.35		
		f _{o700}		2.10	2.25	2.40		
Tint Control Range (f _o = 600kHz)	3NΔθ1	—	(Note C ₆)	35.0	45.0	55.0	°	
	3NΔθ2	—		-55.0	-45.0	-35.0		
	4NΔθ1	—		35.0	45.0	55.0		
	4NΔθ2	—						
Tint Control Variable Range (f _o = 600kHz)	3NΔθT	—	(Note C ₇)	70.0	90.0	110.0		
	4NΔθT	—						
Tint Control Characteristic	3TθTin	—	(Note C ₈)	39	40	47	bit	
	3EθTin	—		73	80	87	Step	
	3NΔTin	—		39	40	47	bit	
	4TθTin	—		73	80	87	Step	
	4EθTin	—						
	4NΔTin	—						
APC Lead-In Range (Lead-In Range)	4.433PH	—	(Note C ₉)	350	500	1500	Hz	
	4.433PL	—		-350	-500	-1500		
	3.579PH	—		350	500	1700		
	3.579PL	—		-350	-500	-1700		
	(Variable Range)	4.433HH		—	400	500		1100
		4.433HL		—	-400	-500		-1100
		3.579HH		—	400	500		1100
		3.579HL		—	-400	-500		-1100
APC Control Sensitivity	3.58β3	—	(Note C ₁₀)	1.50	2.2	2.90	—	
	4.43β3	—		1.70	2.4	3.10		
	M-PALβM	—		1.50	2.2	2.90		
	N-PALβN	—						

CHARACTERISTIC	SYMBOL	TEST CIR-CUIT	TEST CONDITION	MIN	TYP.	MAX	UNIT	
Killer Operation Input Level	3N-VTK1	—	(Note C ₁₁)	1.8	2.5	3.2	mV _{p-p}	
	3N-VTC1	—		2.2	3.2	4.0		
	3N-VTK2	—		2.5	3.6	4.5		
	3N-VTC2	—		3.2	4.5	5.6		
	4N-VTK1	—		1.8	2.5	3.2		
	4N-VTC1	—		2.2	3.2	4.0		
	4N-VTK2	—		2.5	3.6	4.5		
	4N-VTC2	—		3.2	4.5	5.6		
	4P-VTK1	—		1.8	2.5	3.2		
	4P-VTC1	—		2.2	3.2	4.0		
	4P-VTK2	—		2.5	3.6	4.5		
	4P-VTC2	—		3.2	4.5	5.6		
	MP-VTK1	—		1.8	2.5	3.2		
	MP-VTC1	—		2.2	3.2	4.0		
	MP-VTK2	—		2.5	3.6	4.5		
	MP-VTC2	—		3.2	4.5	5.6		
	NP-VTK1	—		1.8	2.5	3.2		
	NP-VTC1	—		2.2	3.2	4.0		
NP-VTK2	—	2.5	3.6	4.5				
NP-VTC2	—	3.2	4.5	5.6				
Color Difference Output (Rainbow Color Bar)	3NeB-Y	—	(Note C ₁₂)	320	380	460		
	3NeR-Y	—		240	290	350		
	4NeB-Y	—		320	380	460		
	4NeR-Y	—		240	290	350		
	4PeB-Y	—		360	430	520		
	4PeR-Y	—		200	240	290		
	(75% Color Bar)	4Peb-y		—	540	650		780
		4Per-y		—	430	510		610
Demodulation Relative Amplitude	3NG _{R/B}	—	(Note C ₁₃)	0.69	0.77	0.86	times	
	4NG _{R/B}	—		0.70	0.77	0.85		
	4PG _{R/B}	—		0.49	0.56	0.64		
Demodulation Relative Phase	3Nθ _{R-B}	—	(Note C ₁₄)	85	93	100	°	
	4Nθ _{R-B}	—		87	93	99		
	4Pθ _{R-B}	—		85	90	95		
Demodulation Output Residual Carrier	3N-SCB	—	(Note C ₁₅)	0	5	15	mV _{p-p}	
	3N-SCR	—						
	4N-SCB	—						
	4N-SCR	—						

CHARACTERISTIC	SYMBOL	TEST CIR-CUIT	TEST CONDITION	MIN	TYP.	MAX	UNIT
Demodulation Output Residual Higher Harmonic	3N-HCB	—	(Note C ₁₆)	0	10	30	mV _{p-p}
	3N-HCR	—					
	4N-HCB	—					
	4N-HCR	—					
Color Difference Output ATT Check	B-Y - 1dB	—	(Note C ₁₇)	-1.20	-0.9	-0.60	dB
	B-Y - 2dB	—		-2.30	-1.7	-1.55	
	B-Y+1dB	—		0.60	0.8	1.20	
16.2MHz Oscillation Frequency	Δf_{oF}	—	(Note C ₁₈)	-2.0	0	2.0	kHz
16.2MHz Oscillation Start Voltage	V _{Fon1}	—	(Note C ₁₉)	3.0	3.2	3.4	V
f _{sc} Free-Run Frequency (3.58M)	3fr	—	(Note C ₂₀)	-100	50	200	Hz
	(4.43M) 4fr	—		-125	25	175	
	(M-PAL) Mfr	—		-140	10	160	
	(N-PAL) Nfr	—					
f _{sc} Output Amplitude	4.43e27	—	(Note C ₂₁)	420	500	580	mV _{p-p}
	3.58e27	—					
f _{sc} Output DC Voltage	3.58eV27	—	—	2.6	2.9	3.2	V
	0th V27	—		1.6	1.9	2.2	

DEF section

CHARACTERISTIC	SYMBOL	TEST CIR-CUIT	TEST CONDITION	MIN	TYP.	MAX	UNIT
H. Reference Frequency	FHVCO	—	(Note DH1)	5.95	6.0	6.10	MHz
H. Reference Oscillation Start Voltage	VSHVCO	—	(Note DH2)	2.3	2.6	2.9	V
H. Output Frequency 1	fH1	—	(Note DH3)	15.5	15.625	15.72	kHz
H. Output Frequency 2	fH2	—	(Note DH4)	15.62	15.734	15.84	
H. Output Duty 1	H ϕ 1	—	(Note DH5)	39	41	43	%
H. Output Duty 2	H ϕ 2	—	(Note DH6)	35	37	39	
H. Output Duty Switching Voltage 1	V ₅₋₁	—	(Note DH7)	1.2	1.5	1.8	V
H. Output Voltage	VHH	—	(Note DH8)	4.5	5.0	5.5	
	VHL	—		—	—	0.5	
H. Output Oscillation Start Voltage	VHS	—	(Note DH9)	—	5.0	—	
H. FBP Phase	ϕ FBP	—	(Note DH10)	6.2	6.9	7.6	μ s
H. Picture Position, Maximum	HSFTmax	—	(Note DH11)	17.7	18.4	19.1	
H. Picture Position, Minimum	HSFTmin	—	(Note DH12)	12.4	13.1	13.8	
H. Picture Position Control Range	Δ HSFT	—	(Note DH13)	4.5	5.3	6.1	

CHARACTERISTIC	SYMBOL	TEST CIRCUIT	TEST CONDITION	MIN	TYP.	MAX	UNIT
H. Distortion Correction Control Range	Δ HCC	—	(Note DH14)	0.5	1.0	1.5	μ s / V
H. BLK Phase	ϕ BLK	—	(Note DH15)	6.2	6.9	7.6	μ s
H. BLK Width, Minimum	BLKmin	—	(Note DH16)	9.8	10.5	11.3	
H. BLK Width, Maximum	BLKmax	—	(Note DH17)	13.2	14.0	14.7	
P / N-GP Start Phase 1	SPGP1	—	(Note DH18)	3.45	3.68	3.90	
P / N-GP Start Phase 2	SPGP2	—	(Note DH19)	3.95	4.18	4.40	
P / N-GP Gate Width 1	PGPW1	—	(Note DH20)	1.65	1.75	1.85	
P / N-GP Gate Width 2	PGPW2	—	(Note DH21)	1.70	1.75	1.85	
SECAM-GP Start Phase 1	SSGP1	—	(Note DH22)	5.2	5.4	5.6	
SECAM-GP Start Phase 2	SSGP2	—	(Note DH23)	5.7	6.0	6.2	
SECAM-GP Gate Width 1	SGPW1	—	(Note DH24)	1.9	2.0	2.1	
SECAM-GP Gate Width 2	SGPW2	—	(Note DH25)	1.9	2.0	2.1	
Noise Detection Level 1	NL1	—	(Note DH26)	0.12	0.20	0.28	
Noise Detection Level 2	NL2	—	(Note DH27)	0.10	0.15	0.20	
Noise Detection Level 3	NL3	—	(Note DH28)	0.05	0.10	0.15	
Noise Detection Level 4	NL4	—	(Note DH29)	0.025	0.05	0.08	
V. Ramp Amplitude	Vramp	—	(Note DV1)	1.62	2.0	2.08	V_{p-p}
V. NF Maximum Amplitude	VNFmax	—	(Note DV2)	3.2	3.5	3.8	
V. NF Minimum Amplitude	VNFmin	—	(Note DV3)	0.8	1.0	1.2	
V. Amplification Degree	GVA	—	(Note DV4)	20	26	32	dB
V. Amplifier Max. Output	Vvmax	—	(Note DV5)	5.0	—	—	V
V. Amplifier Min. Output	Vvmin	—	(Note DV6)	0	—	1.5	
V. S-Curve Correction, Max. Correction Quantity	V _S	—	(Note DV7)	9	11	13	%
V. Reverse S-Curve Correction, Max. Correction Quantity	V _{SR}	—	(Note DV8)				
V. Linearity Max. Correction Quantity	V _L	—	(Note DV9)				

CHARACTERISTIC	SYMBOL	TEST CIRCUIT	TEST CONDITION	MIN	TYP.	MAX	UNIT
AFC-MASK Start Phase	ϕ AFCf	—	(Note DV10)	2.6	3.2	3.8	H
AFC-MASK Stop Phase	ϕ AFCe	—	(Note DV11)	4.4	5.0	5.6	
VNFB phase	ϕ VNFB	—	(Note DV12)	0.45	0.75	1.05	
V. Output Maximum Phase	V ϕ max	—	(Note DV13)	7.3	8.0	8.7	
V. Output Minimum Phase	V ϕ min	—	(Note DV14)	0.5	1.0	1.5	
V. Output Phase Variable Range	Δ V ϕ	—	(Note DV15)	6.3	7.0	7.7	
50 System VBLK Start Phase	V50BLKf	—	(Note DV16)	0.4	0.55	0.7	
50 System VBLK Stop Phase	V50BLKe	—	(Note DV17)	20	23	26	
60 System VBLK Start Phase	V60BLKf	—	(Note DV18)	0.4	0.55	0.7	
60 System VBLK Stop Phase	V60BLKe	—	(Note DV19)	15	18	21	
Pin 56 VBLK Max Voltage	V56H	—		4.7	5.0	5.3	V
Pin 56 VBLK Min Voltage	V56L	—		0	—	0.3	
V. Lead-In Range 1	VAcaL	—	(Note DV20)	—	232.5	—	Hz
	VAcaH	—		—	344.5	—	
V. Lead-In Range 2	V60caL	—	(Note DV21)	—	232.5	—	
	V60caH	—		—	294.5	—	
W-VBLK Start Phase	SWVB	—	(Note DV22)	9	—	88	H
W-PMUTE Start Phase	SWP	—	(Note DV23)				
W-VBLK Stop Phase	STWVB	—	(Note DV24)	10	—	120	
W-PMUTE Stop Phase	STWP	—	(Note DV25)				
V Centering Center Voltage	V51	—	(Note DV26)	—	4.55	—	V
V Centering Max Voltage	V51Max	—	(Note DV27)	—	6.30	—	
V Centering Min Voltage	V51Min	—	(Note DV28)	—	2.75	—	
Pin 28 DAC Output Voltage (High)	V28H	—		4.0	4.5	5.0	
Pin 28 DAC Output Voltage (Low)	V28L	—		—	0	0.1	

1H DL section

CHARACTERISTIC	SYMBOL	TEST CIR-CUIT	TEST CONDITION	MIN	TYP.	MAX	UNIT																																																																																																																															
1HDL Dynamic Range, Direct	VNBD	—	(Note H ₁)	0.8	1.2	—	V																																																																																																																															
	VNRD	—						1HDL Dynamic Range, Delay	VPBD	—	(Note H ₂)	0.8	1.2	—	VPRD	—	1HDL Dynamic Range, Direct+Delay	VSBD	—	(Note H ₃)	0.9	1.2	—	VSRD	—	Frequency Characteristic, Direct	GHB1	—	(Note H ₄)	-3.0	-2.0	0.5	dB	GHR1	—	Frequency Characteristic, Delay	GHB2	—	(Note H ₅)	-8.2	-6.5	-4.3	GHR2	—	AC Gain, Direct	GBY1	—	(Note H ₆)	-2.0	-0.5	2.0	GRY1	—	AC Gain, Delay	GBY2	—	(Note H ₇)	-2.4	-0.5	1.1	GRY2	—	Direct-Delay AC Gain Difference	GBYD	—	(Note H ₈)	-1.0	0.0	1.0	GRYD	—	Color Difference Output DC Stepping	VBD	—	(Note H ₉)	-5	0.0	5	mV	VRD	—	1H Delay Quantity	BDt	—	(Note H ₁₀)	63.7	64.0	64.4	μs	RDt	—	Color Difference Output	Bomin	—	(Note H ₁₁)	22	36	55	mV	DC-Offset Control	Bomax	—	-55	-36	-22	Bus-Min Data	Romin	—	22	36	55	Bus-Max Data	Romax	—	-55	-36	-22	Color Difference Output DC-Offset Control / Min. Control Quantity	Bo1	—	(Note H ₁₂)	1	4	8	dB	Ro1	—	NTSC Mode Gain / NTSC-COM Gain	GNB	—	(Note H ₁₃)	-0.90	0	1.20
1HDL Dynamic Range, Delay	VPBD	—	(Note H ₂)	0.8	1.2	—																																																																																																																																
	VPRD	—						1HDL Dynamic Range, Direct+Delay	VSBD	—	(Note H ₃)	0.9	1.2	—	VSRD	—	Frequency Characteristic, Direct	GHB1	—	(Note H ₄)	-3.0	-2.0	0.5	dB	GHR1	—	Frequency Characteristic, Delay	GHB2	—	(Note H ₅)	-8.2	-6.5		-4.3	GHR2	—	AC Gain, Direct	GBY1	—	(Note H ₆)	-2.0	-0.5	2.0	GRY1	—	AC Gain, Delay	GBY2	—	(Note H ₇)	-2.4	-0.5	1.1	GRY2	—	Direct-Delay AC Gain Difference	GBYD	—	(Note H ₈)	-1.0	0.0	1.0	GRYD	—	Color Difference Output DC Stepping	VBD	—	(Note H ₉)	-5	0.0	5	mV	VRD	—	1H Delay Quantity	BDt	—	(Note H ₁₀)	63.7	64.0	64.4	μs	RDt	—	Color Difference Output	Bomin	—	(Note H ₁₁)	22	36	55	mV	DC-Offset Control	Bomax	—		-55	-36	-22		Bus-Min Data	Romin	—	22	36	55	Bus-Max Data	Romax	—	-55	-36	-22	Color Difference Output DC-Offset Control / Min. Control Quantity	Bo1	—	(Note H ₁₂)	1	4	8	dB	Ro1	—	NTSC Mode Gain / NTSC-COM Gain	GNB	—		(Note H ₁₃)	-0.90	0	1.20	GNR	—	0.92	0	1.58
1HDL Dynamic Range, Direct+Delay	VSBD	—	(Note H ₃)	0.9	1.2	—																																																																																																																																
	VSRD	—						Frequency Characteristic, Direct	GHB1	—	(Note H ₄)	-3.0	-2.0	0.5	dB	GHR1	—	Frequency Characteristic, Delay	GHB2	—	(Note H ₅)	-8.2	-6.5		-4.3	GHR2	—	AC Gain, Direct	GBY1	—	(Note H ₆)	-2.0		-0.5	2.0	GRY1	—	AC Gain, Delay	GBY2	—	(Note H ₇)	-2.4	-0.5	1.1	GRY2	—	Direct-Delay AC Gain Difference	GBYD	—	(Note H ₈)	-1.0	0.0	1.0	GRYD	—	Color Difference Output DC Stepping	VBD	—	(Note H ₉)	-5	0.0	5	mV	VRD	—	1H Delay Quantity	BDt	—	(Note H ₁₀)	63.7	64.0	64.4	μs	RDt	—	Color Difference Output	Bomin	—	(Note H ₁₁)	22	36	55	mV	DC-Offset Control	Bomax	—		-55	-36	-22		Bus-Min Data	Romin	—	22	36	55	Bus-Max Data	Romax	—	-55	-36	-22	Color Difference Output DC-Offset Control / Min. Control Quantity	Bo1	—	(Note H ₁₂)	1	4	8	dB	Ro1	—	NTSC Mode Gain / NTSC-COM Gain	GNB	—	(Note H ₁₃)	-0.90		0	1.20	GNR	—	0.92		0	1.58							
Frequency Characteristic, Direct	GHB1	—	(Note H ₄)	-3.0	-2.0	0.5	dB																																																																																																																															
	GHR1	—						Frequency Characteristic, Delay	GHB2	—	(Note H ₅)	-8.2	-6.5	-4.3		GHR2	—	AC Gain, Direct	GBY1	—	(Note H ₆)	-2.0	-0.5		2.0	GRY1	—	AC Gain, Delay	GBY2	—	(Note H ₇)	-2.4		-0.5	1.1	GRY2	—	Direct-Delay AC Gain Difference	GBYD	—	(Note H ₈)	-1.0	0.0	1.0	GRYD	—	Color Difference Output DC Stepping	VBD	—	(Note H ₉)	-5	0.0	5	mV	VRD	—	1H Delay Quantity	BDt	—	(Note H ₁₀)	63.7	64.0	64.4	μs	RDt	—	Color Difference Output	Bomin	—	(Note H ₁₁)	22	36	55	mV	DC-Offset Control	Bomax	—	-55		-36	-22	Bus-Min Data		Romin	—	22	36	55	Bus-Max Data	Romax	—	-55	-36	-22	Color Difference Output DC-Offset Control / Min. Control Quantity	Bo1	—	(Note H ₁₂)	1	4	8	dB	Ro1	—	NTSC Mode Gain / NTSC-COM Gain	GNB	—	(Note H ₁₃)	-0.90	0		1.20	GNR	—	0.92	0	1.58																	
Frequency Characteristic, Delay	GHB2	—	(Note H ₅)	-8.2	-6.5	-4.3																																																																																																																																
	GHR2	—						AC Gain, Direct	GBY1	—	(Note H ₆)	-2.0	-0.5	2.0		GRY1	—	AC Gain, Delay	GBY2	—	(Note H ₇)	-2.4	-0.5		1.1	GRY2	—	Direct-Delay AC Gain Difference	GBYD	—	(Note H ₈)	-1.0		0.0	1.0	GRYD	—	Color Difference Output DC Stepping	VBD	—	(Note H ₉)	-5	0.0	5	mV	VRD	—	1H Delay Quantity	BDt	—	(Note H ₁₀)	63.7	64.0	64.4	μs	RDt	—	Color Difference Output	Bomin	—	(Note H ₁₁)	22	36	55	mV	DC-Offset Control	Bomax	—	-55		-36	-22	Bus-Min Data		Romin	—	22	36	55	Bus-Max Data	Romax	—	-55	-36	-22	Color Difference Output DC-Offset Control / Min. Control Quantity	Bo1	—	(Note H ₁₂)	1	4	8	dB	Ro1	—	NTSC Mode Gain / NTSC-COM Gain	GNB	—	(Note H ₁₃)	-0.90	0		1.20	GNR	—	0.92	0	1.58																										
AC Gain, Direct	GBY1	—	(Note H ₆)	-2.0	-0.5	2.0																																																																																																																																
	GRY1	—						AC Gain, Delay	GBY2	—	(Note H ₇)	-2.4	-0.5	1.1		GRY2	—	Direct-Delay AC Gain Difference	GBYD	—	(Note H ₈)	-1.0	0.0		1.0	GRYD	—	Color Difference Output DC Stepping	VBD	—	(Note H ₉)	-5	0.0	5	mV	VRD	—	1H Delay Quantity	BDt	—	(Note H ₁₀)	63.7	64.0	64.4	μs	RDt	—	Color Difference Output	Bomin	—	(Note H ₁₁)	22	36	55	mV	DC-Offset Control	Bomax	—	-55	-36		-22	Bus-Min Data	Romin		—	22	36	55	Bus-Max Data	Romax	—	-55	-36	-22	Color Difference Output DC-Offset Control / Min. Control Quantity	Bo1	—	(Note H ₁₂)	1	4	8	dB	Ro1	—	NTSC Mode Gain / NTSC-COM Gain	GNB	—	(Note H ₁₃)	-0.90	0	1.20		GNR	—	0.92	0	1.58																																				
AC Gain, Delay	GBY2	—	(Note H ₇)	-2.4	-0.5	1.1																																																																																																																																
	GRY2	—						Direct-Delay AC Gain Difference	GBYD	—	(Note H ₈)	-1.0	0.0	1.0		GRYD	—	Color Difference Output DC Stepping	VBD	—	(Note H ₉)	-5	0.0	5	mV	VRD	—	1H Delay Quantity	BDt	—	(Note H ₁₀)	63.7	64.0	64.4	μs	RDt	—	Color Difference Output	Bomin	—	(Note H ₁₁)	22	36	55	mV	DC-Offset Control	Bomax	—	-55	-36		-22	Bus-Min Data	Romin		—	22	36	55	Bus-Max Data	Romax	—	-55	-36	-22	Color Difference Output DC-Offset Control / Min. Control Quantity	Bo1	—	(Note H ₁₂)	1	4	8	dB	Ro1	—	NTSC Mode Gain / NTSC-COM Gain	GNB	—	(Note H ₁₃)	-0.90	0	1.20		GNR	—	0.92	0	1.58																																														
Direct-Delay AC Gain Difference	GBYD	—	(Note H ₈)	-1.0	0.0	1.0																																																																																																																																
	GRYD	—						Color Difference Output DC Stepping	VBD	—	(Note H ₉)	-5	0.0	5	mV	VRD	—	1H Delay Quantity	BDt	—	(Note H ₁₀)	63.7	64.0	64.4	μs	RDt	—	Color Difference Output	Bomin	—	(Note H ₁₁)	22	36	55	mV	DC-Offset Control	Bomax	—	-55	-36		-22	Bus-Min Data	Romin		—	22	36	55	Bus-Max Data	Romax	—	-55	-36	-22	Color Difference Output DC-Offset Control / Min. Control Quantity	Bo1	—	(Note H ₁₂)	1	4	8	dB	Ro1	—	NTSC Mode Gain / NTSC-COM Gain	GNB	—	(Note H ₁₃)	-0.90	0	1.20		GNR	—	0.92	0	1.58																																																								
Color Difference Output DC Stepping	VBD	—	(Note H ₉)	-5	0.0	5	mV																																																																																																																															
	VRD	—						1H Delay Quantity	BDt	—	(Note H ₁₀)	63.7	64.0	64.4	μs	RDt	—	Color Difference Output	Bomin	—	(Note H ₁₁)	22	36	55	mV	DC-Offset Control	Bomax	—	-55	-36		-22	Bus-Min Data	Romin		—	22	36	55	Bus-Max Data	Romax	—	-55	-36	-22	Color Difference Output DC-Offset Control / Min. Control Quantity	Bo1	—	(Note H ₁₂)	1	4	8	dB	Ro1	—	NTSC Mode Gain / NTSC-COM Gain	GNB	—	(Note H ₁₃)	-0.90	0	1.20		GNR	—	0.92	0	1.58																																																																		
1H Delay Quantity	BDt	—	(Note H ₁₀)	63.7	64.0	64.4	μs																																																																																																																															
	RDt	—						Color Difference Output	Bomin	—	(Note H ₁₁)	22	36	55	mV	DC-Offset Control	Bomax	—	-55	-36		-22	Bus-Min Data	Romin		—	22	36	55	Bus-Max Data	Romax	—	-55	-36	-22	Color Difference Output DC-Offset Control / Min. Control Quantity	Bo1	—	(Note H ₁₂)	1	4	8	dB	Ro1	—	NTSC Mode Gain / NTSC-COM Gain	GNB	—	(Note H ₁₃)	-0.90	0	1.20		GNR	—	0.92	0	1.58																																																																												
Color Difference Output	Bomin	—	(Note H ₁₁)	22	36	55	mV																																																																																																																															
DC-Offset Control	Bomax	—		-55	-36	-22																																																																																																																																
Bus-Min Data	Romin	—		22	36	55																																																																																																																																
Bus-Max Data	Romax	—		-55	-36	-22																																																																																																																																
Color Difference Output DC-Offset Control / Min. Control Quantity	Bo1	—	(Note H ₁₂)	1	4	8	dB																																																																																																																															
	Ro1	—						NTSC Mode Gain / NTSC-COM Gain	GNB	—	(Note H ₁₃)	-0.90	0	1.20	GNR	—	0.92	0	1.58																																																																																																																			
NTSC Mode Gain / NTSC-COM Gain	GNB	—	(Note H ₁₃)	-0.90	0	1.20																																																																																																																																
	GNR	—		0.92	0	1.58																																																																																																																																

CHARACTERISTIC	SYMBOL	TEST CIR-CUIT	TEST CONDITION	MIN	TYP.	MAX	UNIT
Y Color Difference Clamping Voltage	Vcp31	—	(Note T ₁)	1.7	2.0	2.3	V
	Vcp33	—		2.2	2.5	2.8	
	Vcp34	—					
Contrast Control Characteristic	Vc12mx	—	(Note T ₂)	2.50	3.00	3.50	
	Vc12mn	—		0.21	0.31	0.47	
	D12c80	—		0.83	1.24	1.86	
	Vc13mx	—		2.50	3.00	3.50	
	Vc13mn	—		0.21	0.31	0.47	
	D13c80	—		0.83	1.24	1.86	
	Vc14mx	—		2.50	3.00	3.50	
	Vc14mn	—		0.21	0.31	0.47	
AC Gain	Gr	—	(Note T ₃)	2.8	4.0	5.2	times
	Gg	—					
	Gb	—					
Frequency Characteristic	Gf	—	(Note T ₄)	—	-1.0	-3.0	dB
Y Sub-Contrast Control Characteristic	ΔV_{scnt}	—	(Note T ₅)	3.0	6.0	9.0	V
Y ₂ Input Range	Vy2d	—	(Note T ₆)	0.7	—	—	
Unicolor Control Characteristic	Vn12mx	—	(Note T ₇)	1.6	2.3	4.3	V
	Vn12mn	—		0.17	0.35	0.42	
	D12n80	—		0.67	1.16	1.68	
	Vn13mx	—		1.6	2.3	4.3	
	Vn13mn	—		0.17	0.35	0.42	
	D13n80	—		0.67	1.16	1.68	
	Vn14mx	—		1.6	2.3	4.3	
	Vn14mn	—		0.17	0.26	0.42	
	D14n80	—		0.67	1.16	1.68	
	ΔV_{13un}	—		16	20	24	dB
Relative Amplitude (NTSC)	Mnr-b	—	(Note T ₈)	0.70	0.77	0.85	times
	Mng-b	—		0.30	0.34	0.38	
Relative Phase (NTSC)	θ_{nr-b}	—	(Note T ₉)	87	93	99	°
	θ_{ng-b}	—		235	241.5	248	
Relative Amplitude (PAL)	Mpr-b	—	(Note T ₁₀)	0.50	0.56	0.63	times
	Mpg-b	—		0.30	0.34	0.38	
Relative Phase (PAL)	θ_{pr-b}	—	(Note T ₁₁)	86	90	94	°
	θ_{pg-b}	—		232	237	242	

CHARACTERISTIC	SYMBOL	TEST CIRCUIT	TEST CONDITION	MIN	TYP.	MAX	UNIT
Color Control Characteristic	Vcmx	—	(Note T ₁₂)	1.50	1.80	2.10	V _{p-p}
	e _{col}	—		80	128	160	step
	Δ _{col}	—		142	192	242	
Color Control Characteristic, Residual Color	e _{cr}	—	(Note T ₁₃)	0	12.5	25	mV _{p-p}
	e _{cg}	—					
	e _{cb}	—					
Chroma Input Range	V _{cr}	—	(Note T ₁₄)	700	—	—	
Brightness Control Characteristic	V _{brmx}	—	(Note T ₁₅)	3.05	3.45	3.85	V
	V _{brmn}	—		1.05	1.35	1.65	
Brightness Center Voltage	V _{bcnt}	—	(Note T ₁₆)	2.05	2.30	2.55	
Brightness Data Sensitivity	ΔV _{brt}	—	(Note T ₁₇)	6.3	7.8	9.4	mV
RGB Output Voltage Axes Difference	ΔV _{bct}	—	(Note T ₁₈)	-150	0	150	
White Peak Limit Level	V _{wpl}	—	(Note T ₁₉)	2.63	3.25	3.75	
Cutoff Control Characteristic	V _{comx}	—	(Note T ₂₀)	2.55	2.75	2.95	V
	V _{comn}	—		1.55	1.75	1.95	
Cutoff Center Level	V _{coct}	—	(Note T ₂₁)	2.05	2.3	2.55	
Cutoff Variable Range	ΔD _{cut}	—	(Note T ₂₂)	2.3	3.9	5.5	mV
Drive Variable Range	DR+	—	(Note T ₂₃)	2.7	3.85	5.0	dB
	DR-	—		-6.5	-5.6	-4.7	
DC Regeneration	TDC	—	(Note T ₂₄)	0	50	100	mV
RGB Output S / N Ratio	S _{No}	—	(Note T ₂₅)	—	-50	-45	dB
Blanking Pulse Output Level	V _v	—	(Note T ₂₆)	0.7	1.0	1.3	V
	V _h	—					
Blanking Pulse Delay Time	t _{don}	—	(Note T ₂₇)	0.05	0.25	0.45	μs
	t _{doff}	—		0.05	0.35	0.85	
RGB Min. Output Level	V _{mn}	—	(Note T ₂₈)	0.8	1.0	1.2	V
RGB Max. Output Level	V _{mx}	—	(Note T ₂₉)	6.85	7.15	7.45	
Halftone Ys Level	V _{thtl}	—	(Note T ₃₀)	0.7	0.9	1.1	
Halftone Gain 1	G _{3htl3}	—	(Note T ₃₁)	-4.5	-3.0	-1.5	dB
Halftone Gain 2	G _{6htl3}	—	(Note T ₃₂)	-7.5	-6.0	-4.5	
Text ON Ys Level	V _{ttxl}	—	(Note T ₃₃)	1.8	2.0	2.2	V
Text / OSD Output, Low Level	V _{txl13}	—	(Note T ₃₄)	-0.45	-0.25	-0.05	
Text RGB Output, High Level	V _{mt13}	—	(Note T ₃₅)	1.15	1.4	1.85	
OSD Ys ON Level	V _{tosl}	—	(Note T ₃₆)	2.8	3.0	3.2	
OSD RGB Output, High Level	V _{mos13}	—	(Note T ₃₇)	1.75	2.15	2.55	
Text Input Threshold Level	V _{txtg}	—	(Note T ₃₈)	0.7	1.0	1.3	
OSD Input Threshold Level	V _{osdg}	—	(Note T ₃₉)	1.7	2.0	2.3	

CHARACTERISTIC	SYMBOL	TEST CIR-CUIT	TEST CONDITION	MIN	TYP.	MAX	UNIT
OSD Mode Switching Rise-Up Time	T_{Rosr}	—	(Note T ₄₀)	—	40	100	ns
	T_{Rosg}	—					
	T_{Rosb}	—					
OSD Mode Switching Rise-Up Transfer Time	t_{PRosr}	—	(Note T ₄₁)	—	40	100	ns
	t_{PRosg}	—					
	t_{PRosb}	—					
OSD Mode Switching Rise-Up Transfer Time, 3 Axes Difference	Δt_{PRos}	—	(Note T ₄₂)	—	15	40	ns
OSD Mode Switching Breaking Time	T_{Fosr}	—	(Note T ₄₃)	—	30	100	ns
	T_{Fosg}	—					
	T_{Fosb}	—					
OSD Mode Switching Breaking Transfer Time	t_{PFosr}	—	(Note T ₄₄)	—	30	100	ns
	t_{PFosg}	—					
	t_{PFosb}	—					
OSD Mode Switching Breaking Transfer Time, 3 Axes Difference	Δt_{FROS}	—	(Note T ₄₅)	—	20	40	ns
OSD Hi DC Switching Rise-Up Time	T_{Roshr}	—	(Note T ₄₆)	—	20	100	ns
	T_{Roshg}	—					
	T_{Roshb}	—					
OSD Hi DC Switching Rise-Up Transfer Time	t_{PRohr}	—	(Note T ₄₇)	—	20	100	ns
	t_{PRohg}	—					
	t_{PRohb}	—					
OSD Hi DC Switching Rise-Up Transfer Time, 3 Axes Difference	Δt_{PRoh}	—	(Note T ₄₈)	—	0	40	ns
OSD Hi DC Switching Breaking Time	T_{Foshr}	—	(Note T ₄₉)	—	20	100	ns
	T_{Foshg}	—					
	T_{Foshb}	—					
OSD Hi DC Switching Breaking Transfer Time	t_{PFohr}	—	(Note T ₅₀)	—	20	100	ns
	t_{PFohg}	—					
	t_{PFohb}	—					
OSD Hi DC Switching Breaking Transfer Time, 3 Axes Difference	Δt_{PFoh}	—	(Note T ₅₁)	—	0	40	ns

CHARACTERISTIC	SYMBOL	TEST CIRCUIT	TEST CONDITION	MIN	TYP.	MAX	UNIT
RGB Contrast Control Characteristic	Vc12mx	—	(Note T ₅₂)	2.10	2.5	2.97	V
	Vc12mn	—		0.21	0.31	0.47	
	D12c80	—		0.84	1.25	1.87	
	Vc13mx	—		2.10	2.5	2.97	
	Vc13mn	—		0.21	0.31	0.47	
	D13c80	—		0.84	1.25	1.87	
	Vc14mx	—		2.10	2.5	2.97	
	Vc14mn	—		0.21	0.31	0.47	
	D14c80	—		0.84	1.25	1.87	
Analog RGB AC Gain	Gag	—	(Note T ₅₃)	4.0	5.1	6.3	times
Analog RGB Frequency Characteristic	Gfg	—	(Note T ₅₄)	-0.5	-1.75	-3.0	dB
Analog RGB Dynamic Range	Dr24	—	(Note T ₅₅)	0.5	—	—	V
RGB Brightness Control Characteristic	Vbrmxg	—	(Note T ₅₆)	3.05	3.25	3.45	
	Vbrmng	—		1.05	1.25	1.45	
RGB Brightness Center Voltage	Vbcntg	—	(Note T ₅₇)	2.05	2.25	2.45	
RGB Brightness Data Sensitivity	ΔV_{brtg}	—	(Note T ₅₈)	6.3	7.8	9.4	mV
Analog RGB Mode ON Voltage	Vanath	—	(Note T ₅₉)	0.8	1.0	1.2	V
Analog RGB Switching Rise-Up Time	T _{Ranr}	—	(Note T ₆₀)	—	50	100	ns
	T _{Rang}	—					
	T _{Ranb}	—					
Analog RGB Switching Rise-Up Transfer Time	t _{PRanr}	—	(Note T ₆₁)	—	20	100	
	t _{PRang}	—					
	t _{PRanb}	—					
Analog RGB Switching Rise-Up Transfer Time, 3 Axes Difference	Δt_{PRas}	—	(Note T ₆₂)	—	0	40	
Analog RGB Switching Breaking Time	T _{Fanr}	—	(Note T ₆₃)	—	50	100	
	T _{Fang}	—					
	T _{Fanb}	—					
Analog RGB Switching Breaking Transfer Time	t _{PFanr}	—	(Note T ₆₄)	—	30	100	
	t _{PFang}	—					
	t _{PFanb}	—					
Analog RGB Switching Breaking Transfer Time, 3 Axes Difference	Δt_{PFas}	—	(Note T ₆₅)	—	0	40	

CHARACTERISTIC	SYMBOL	TEST CIRCUIT	TEST CONDITION	MIN	TYP.	MAX	UNIT
Analog RGB Hi Switching Rise-Up Time	T_{Ranhr}	—	(Note T ₆₆)	—	50	100	ns
	T_{Ranhg}	—					
	T_{Ranhb}	—					
Analog RGB Hi Switching Rise-Up Transfer Time	t_{PRahr}	—	(Note T ₆₇)	—	20	100	
	t_{PRahg}	—					
	t_{PRahb}	—					
Analog RGB Hi Switching Rise-Up Transfer Time, 3 Axes Difference	Δt_{PRah}	—	(Note T ₆₈)	—	0	40	
Analog RGB Hi Switching Breaking Time	t_{Fanhr}	—	(Note T ₆₉)	—	50	100	
	t_{Fanhg}	—					
	t_{Fanhb}	—					
Analog RGB Hi Switching Breaking Transfer Time	t_{PFahr}	—	(Note T ₇₀)	—	20	100	
	t_{PFahg}	—					
	t_{PFahb}	—					
Analog RGB Hi Switching Breaking Transfer Time, 3 Axes Difference	Δt_{PFah}	—	(Note T ₇₁)	—	0	40	
TV-Analog RGB Crosstalk	$Crtvag$	—	(Note T ₇₂)	-80	-50	-40	dB
Analog RGB-TV Crosstalk	$Crantg$	—	(Note T ₇₃)				
ABL Point Characteristic	$Vablpl$	—	(Note T ₇₄)	5.5	5.6	5.7	V
	$Vablpc$	—		5.7	5.8	5.9	
	$Vablph$	—		5.9	6.0	6.1	
ACL Characteristic	$Vcal$	—	(Note T ₇₅)	-19	-16	-13	dB
ABL Gain Characteristic	$Vabll$	—	(Note T ₇₆)	-0.3	0	0.3	V
	$Vablc$	—		-1.3	-1.0	-0.7	
	$Vablh$	—		-2.3	-2.0	-1.7	

CHARACTERISTIC	SYMBOL	TEST CIRCUIT	TEST CONDITION	MIN	TYP.	MAX	UNIT
Bell Monitor Output Amplitude	embo	—	(Note S ₁)	200	300	400	mV _{p-p}
Bell Filter f ₀	foB-C	—	(Note S ₂)	-23	0	23	kHz
Bell Filter f ₀ Variable Range	foB-L	—	(Note S ₃)	-69	-46	-23	
	foB-H	—		69	92	115	
Bell Filter Q	QBEL	—	(Note S ₄)	14	16	18	—
Color Difference Output Amplitude	VBS	—	(Note S ₅)	0.50	—	0.91	V _{p-p}
	VRS	—		0.39	—	0.73	
Color Difference Relative Amplitude	R / B-S	—	(Note S ₆)	0.70	—	0.90	—
Color Difference Attenuation Quantity	SATTB	—	(Note S ₇)	-1.50	—	-0.50	dB
	SATTR	—					
Color Difference S / N Ratio	SNB-S	—	(Note S ₈)	-85	—	-25	
	SBR-S	—					
Linearity	LinB	—	(Note S ₉)	75	—	117	%
	LinR	—		85	—	120	
Rising-Fall Time (Standard De-Emphasis)	trfB	—	(Note S ₁₀)	—	1.3	1.5	μs
	trfR	—					
Rising-Fall Time (Wide-Band De-Emphasis)	trfBw	—	(Note S ₁₁)	—	1.1	1.3	
	trfRw	—					
Killer Operation Input Level (Standard Setting)	eSK	—	(Note S ₁₂)	0.5	1	2	mV _{p-p}
	eSC	—					
Killer Operation Input Level (VID ON)	eSFK	—	(Note S ₁₃)	0.5	1	2	
	eSFC	—					
Killer Operation Input Level (Low Sensitivity, VID OFF)	eSWK	—	(Note S ₁₄)	0.7	1.5	3	
	eSWC	—					

TEST CONDITION VIDEO SECTION

NOTE	ITEM	TEST CONDITION (Unless otherwise specified : H, RGB V _{CC} = 9V ; V _{DD} , Fsc V _{DD} , Y / C V _{CC} = 5V ; Ta = 25±3°C)											
		SW MODE					SUB-ADDRESS & BUS DATA						MEASURING METHOD
		S ₃₉	S ₄₂	S ₄₄	S ₄₅	S ₅₁	04H	08H	0FH	10H	13H	14H	
Y ₁	Y Input Pedestal Clamping Voltage	A	C	B	A	A	20H	04H	80H	00H	BAH	03H	(1) Short circuit pin 45 (Y ₁ IN) in AC coupling. (2) Input synchronizing signal to pin 51 (SYNC IN). (3) Measure DC voltage at pin 45, and express the measurement result as VY _{clp} .
Y ₂	Chroma Trap Frequency	↑	↑	A	B	↑	↑	↑	↑	↑	↑	↑	(1) Set the 358 TRAP mode to AUTO by setting the bus data. (2) Set the bus data so that chroma trap is ON and f ₀ is 0. (3) Input TG7 sine wave signal whose frequency is 3.58MHz (NTSC) and video amplitude is 0.5V to pin 45 (Y ₁ IN). (4) While observing waveform at pin 37 (Y _{1out}), find a frequency with minimum amplitude of the waveform. The obtained frequency shall be expressed as flr3. (5) Change the frequency of the signal 1 to 4.43MHz (PAL) and perform the same measurement as the preceding step 4. The obtained frequency shall be expressed as flr4.
Y ₃	Chroma Trap Attenuation (3.58MHz)	↑	↑	↑	↑	↑	↑	↑	Variable	Variable	Variable	↑	(1) Set the 358 TRAP mode to AUTO by setting bus data. (2) Set the bus data so that Q of chroma trap is 1.5. (3) Set the bus data so that f ₀ of chroma trap is 0. (4) Input TG7 sine wave signal whose frequency is 3.58MHz (NTSC) and video amplitude is 0.5V to pin 45 (Y ₁ IN). (5) While turning on and off the chroma trap by controlling the bus, measure chroma amplitude (VTon) at pin 37 (Y _{1out}) with the chroma trap being turned on and measure chroma amplitude (VToff) at pin 37 (Y _{1out}) with the chroma trap being turned off. $G_{tr} = 20\log(V_{Toff} / V_{Ton})$ (6) Change f ₀ of the chroma trap to -100kHz, -50kHz, 0 and +50kHz, and perform the same measurement as the preceding steps 4 and 5 with the respective f ₀ settings. (7) Change Q of the chroma trap t 1, 1.5, 2 and 2.5, and perform the same measurement as the preceding steps 4 through 6. The maximum G _{tr} shall be expressed as G _{tr} 3a. (8) Set the 358 TRAP mode to the forces 358 mode by setting bus data, and perform the same measurement as the preceding steps 2 through 7 (G _{tr} 3f).

NOTE	ITEM	TEST CONDITION (Unless otherwise specified : H, RGB V _{CC} = 9V ; V _{DD} , Fsc V _{DD} , Y / C V _{CC} = 5V ; Ta = 25±3°C)											
		SW MODE					SUB-ADDRESS & BUS DATA						MEASURING METHOD
		S ₃₉	S ₄₂	S ₄₄	S ₄₅	S ₅₁	04H	08H	0FH	10H	13H	14H	
Y ₄	Chroma Trap Attenuation (4.43MHz)	A	C	A	B	A	20H	04H	Variable	Variable	Variable	03H	(1) Set the 358 TRAP mode to AUTO by setting bus data. (2) Set the bus data so that Q of chroma trap is 1.5. (3) Set the bus data so that f ₀ of chroma trap is 0. (4) Input TG7 sine wave signal whose frequency is 4.43MHz and video amplitude is 0.5V to pin 45 (Y ₁ IN). (5) Perform the same measurement as the steps 5 through 7 of the preceding item Y ₃ . The measurement result shall be expressed as Gtr4.
Y ₅	Chroma Trap Attenuation (SECAM)	↑	↑	↑	↑	↑	↑	↑	↑	↑	↑	↑	(1) Set the bus data so that the 358 TRAP mode is AUTO and the Dtrap is ON. (2) Set the bus data so that Q of chroma trap is 1.5. (3) Set the bus data so that f ₀ of chroma trap is 0. (4) Input SECAM signal whose amplitude in video period is 0.5V to pin 45 (Y ₁ IN). (5) Perform the same measurement as the steps 5 through 7 of the preceding item Y ₃ to find the maximum attenuation (Gtrs).
Y ₆	Y _γ Correction Point	↑	↑	↑	↑	↑	↑	Variable	80H	00H	BAH	↑	(1) Connect the power supply to pin 45 (Y ₁ IN). (2) Turn off Y _γ by setting the bus data. (3) While raising the supply voltage from the level measured in the preceding item Y ₁ , measure voltage change characteristic of Y ₁ output at pin 37. (4) Set the bus data to turn on Y _γ . (5) Perform the same measurement as the above step 3. (6) Find a gamma (γ) point from the measurement results of the steps 3 and 5. $\gamma_p = \sqrt{r} + 0.7V$
Y ₇	Y _γ Correction Curve	↑	↑	↑	↑	↑	↑	↑	↑	↑	↑	↑	From the measurement in the above item Y ₆ , find gain of the portion that the γ correction has an effect on.

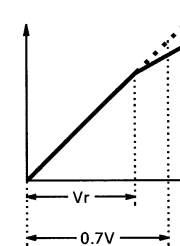

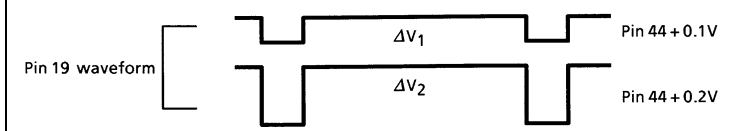
NOTE	ITEM	TEST CONDITION (Unless otherwise specified : H, RGB V _{CC} = 9V ; V _{DD} , Fsc V _{DD} , Y / C V _{CC} = 5V ; Ta = 25±3°C)											MEASURING METHOD
		SW MODE					SUB-ADDRESS & BUS DATA						
		S ₃₉	S ₄₂	S ₄₄	S ₄₅	S ₅₁	04H	08H	0FH	10H	13H	14H	
Y ₈	APL Terminal Output Impedance	A	C	B	A	A	20H	04H	80H	00H	BAH	03H	(1) Short circuit pin 45 (Y ₁ IN) in AC coupling. (2) Input synchronizing signal to pin 51. (3) Connect power supply and an ammeter to the APL of pin 44 as shown in the figure, and adjust the power supply so that the ammeter reads 0 (zero). (4) Raise the voltage at pin 44 by 0.1V, and measure the current (I _{in}) at that time. $Z_{o44} (\Omega) = 0.1V \div I_{in} (A)$
Y ₉	DC Transmission Compensation Amplifier Gain	↑	↑	↑	↑	↑	↑	↑	↑	↑	↑	Variable	(1) Set the bus data so that DC transmission factor correction gain is maximum. (2) In the condition of the Note Y ₈ , observe Y _{1out} waveform at pin 37 and measure voltage change in the video period. (3) Set the bus data so that DC transmission factor correction gain is centered, and measure voltage in the same manner as the above step 2.  $Adr = (\Delta V_2 - \Delta V_1) \div 0.1V \div Y_1 \text{ gain}$
Y ₁₀	Maximum Gain of Black Expansion Amplifier	↑	↑	A	B	↑	↑	↑	00H	↑	↑	E3H	(1) Set the bus data so that black expansion is on and black expansion point is maximum. (2) Input TG7 sine wave signal whose frequency is 500kHz and video amplitude is 0.1V to pin 45 (Y ₁ IN). (3) While impressing 1.0V to pin 39 (Black Peak Hold), measure amplitude (V _a) of Y _{1out} signal at pin 37. (4) While impressing 3.5V to pin 39 (Black Peak Hold), measure amplitude (V _b) of Y _{1out} signal at pin 37. $A_{kc} = V_a \div V_b$

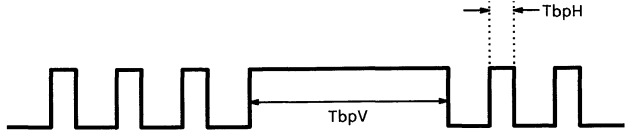
NOTE	ITEM	TEST CONDITION (Unless otherwise specified : H, RGB V _{CC} = 9V ; V _{DD} , Fsc V _{DD} , Y / C V _{CC} = 5V ; Ta = 25±3°C)											MEASURING METHOD
		SW MODE					SUB-ADDRESS & BUS DATA						
		S ₃₉	S ₄₂	S ₄₄	S ₄₅	S ₅₁	04H	08H	0FH	10H	13H	14H	
Y11	Black Expansion Start Point	A	C	A	A	A	20H	04H	00H	00H	BAH	Variable	<p>(1) Set the bus data so that black expansion is on and black expansion point is maximum.</p> <p>(2) Supply 1.0V to pin 39 (Black Peak Hold).</p> <p>(3) Supply 2.9V to the APL of pin 44.</p> <p>(4) Connect the power supply to pin 45 (Y₁ IN). While raising the supply voltage from the level measured in the preceding item Y₁, measure voltage change at pin 37 (Y₁out).</p> <p>(5) Set the bus data to center the black expansion point, and perform the same measurement as the above steps 2 through 4.</p> <p>(6) Set the black expansion point to the minimum by setting the bus data, and perform the same measurement as the above steps 2 through 4.</p> <p>(7) While supplying 2.2V to the APL of pin 44, perform the same measurement as the above step 4 with the black expansion point set to maximum, center and minimum.</p>
Y12	Black Peak Detection Period (Horizontal) Black Peak Detection Period (Vertical)	B	↑	↑	↑	↑	↑	↑	↑	↑	↑	E3H	<p>In the condition of the Note Y₁, measure waveform at pin 39 (Black Peak Hold).</p> 

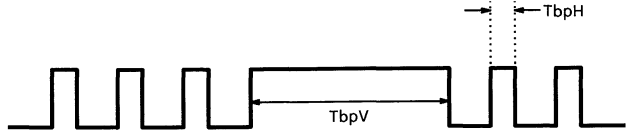
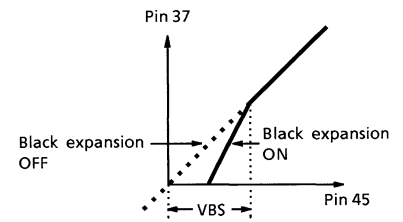

NOTE	ITEM	TEST CONDITION (Unless otherwise specified : H, RGB V _{CC} = 9V ; V _{DD} , Fsc V _{DD} , Y / C V _{CC} = 5V ; Ta = 25±3°C)											
		SW MODE					SUB-ADDRESS & BUS DATA						MEASURING METHOD
		S ₃₉	S ₄₂	S ₄₄	S ₄₅	S ₅₁	04H	08H	0FH	10H	13H	14H	
Y13	Picture Quality Control Peaking Frequency	A	C	A	B	A	3FH	04H	80H	00H	BAH	Variable	(1) Set the bus data so that picture quality control frequency is 2.5MHz. (2) Input TG7 sine wave (sweeper) signal whose video level is 0.1V to pin 45 (Y ₁ IN) and pin 51 (Sync. IN). (3) Maximize the picture quality control data. (4) While observing Y _{1out} of pin 37, find an SG frequency as the waveform amplitude is maximum (fp25). (5) Set the bus data so that picture quality control frequency is 3.1MHz and 4.2MHz, and perform the same measurement as the above steps 2 through 4 at the respective frequencies (fp31, fp42).
Y14	Picture Quality Control Maximum Characteristic	↑	↑	↑	↑	↑	↑	↑	↑	↑	↑	↑	(1) Input TG7 sine wave (sweeper) signal whose video level is 0.1V to pin 45 (Y ₁ IN) and pin 51 (Sync. IN). (2) Set the picture quality control data to maximum. (3) Set the picture quality control frequency is 2.5MHz by setting the bus data. (4) Measure amplitude (V100k) of the output of pin 37 (Y ₁ OUT) as the SG frequency is 100kHz, and the amplitude (Vp25) of the same as the SG frequency is 2.5MHz. $GS25MX = 20\log(Vp25 / V100k)$ (5) Set the picture quality control frequency data to 3.1MHz by setting the bus data. (6) Measure amplitude (V100k) of the output of pin 37 (Y ₁ OUT) as the SG frequency is 100kHz, and the amplitude (Vp31) of the same as the SG frequency is 3.1MHz. $GS31MX = 20\log(Vp31 / V100k)$ (7) Set the picture quality control frequency to 4.2MHz by setting the bus data. (8) Measure amplitude (V100k) of the output of pin 37 (Y ₁ OUT) as the SG frequency is 100kHz, and the amplitude (Vp42) of the same as the SG frequency is 4.2MHz. $GS42MX = 20\log(Vp42 / V100k)$

NOTE	ITEM	TEST CONDITION (Unless otherwise specified : H, RGB V _{CC} = 9V ; V _{DD} , Fsc V _{DD} , Y / C V _{CC} = 5V ; Ta = 25±3°C)											
		SW MODE					SUB-ADDRESS & BUS DATA						MEASURING METHOD
		S ₃₉	S ₄₂	S ₄₄	S ₄₅	S ₅₁	04H	08H	0FH	10H	13H	14H	
Y ₁₅	Picture Quality Control Minimum Characteristic	A	C	A	B	A	00H	04H	80H	00H	BAH	Variable	(1) In the condition of the Note Y ₁₄ , set the picture quality control bus data to minimum. (2) Perform the same measurement as the steps 3 through 8 of the Note Y ₁₄ to find respective gains as the picture quality control frequency is set to 2.5MHz, 3.1MHz and 4.2MHz. $GS25MN = 20\log(Vp25 / V100k)$ $GS31MN = 20\log(Vp31 / V100k)$ $GS42MN = 20\log(Vp42 / V100k)$
Y ₁₆	Picture Quality Control Center Characteristic	↑	↑	↑	↑	↑	20H	↑	↑	↑	↑	↑	(1) In the condition of the Note Y ₁₄ , set the picture quality control bus data to center. (2) Perform the same measurement as the steps 3 through 8 of the Note Y ₁₄ to find respective gains as the picture quality control frequency is set to 2.5MHz, 3.1MHz and 4.2MHz. $GS25CT = 20\log(Vp25 / V100k)$ $GS31CT = 20\log(Vp31 / V100k)$ $GS42CT = 20\log(Vp42 / V100k)$
Y ₁₇	Y Signal Gain	↑	↑	↑	↑	↑	↑	↑	↑	↑	↑	03H	(1) Set the bus data so that black expansion is off, picture quality control is off and DC transmission compensation is minimum. (2) Input TG7 sine wave signal whose frequency is 100kHz and video level is 0.5V to pin 45 (Y ₁ IN) and pin 51 (Sync. IN). (V _{yi100}) (3) Measure amplitude of Y ₁ output at pin 37 (V _{yout}). $Gy = 20\log(Vyout / Vyi100)$
Y ₁₈	Y Signal Frequency Characteristic	↑	↑	↑	↑	↑	↑	↑	↑	↑	↑	↑	(1) Set the bus data so that black expansion is off, picture quality control is off and DC transmission compensation is minimum. (2) Input TG7 sine wave signal whose frequency is 6MHz and video level is 0.5V to pin 45 (Y ₁ IN) and pin 51 (Sync. IN). (V _{yi6M}) (3) Measure amplitude of Y ₁ output at pin 37 (V _{yo6M}). $Gy6M = 20\log(Vyo6M / Vyi6M)$ (4) Find G _{fy} from the result of the Note Y ₁₇ . $Gfy = Gy6M - Gy$

NOTE	ITEM	TEST CONDITION (Unless otherwise specified : H, RGB V _{CC} = 9V ; V _{DD} , Fsc V _{DD} , Y / C V _{CC} = 5V ; Ta = 25±3°C)											MEASURING METHOD
		SW MODE					SUB-ADDRESS & BUS DATA						
		S ₃₉	S ₄₂	S ₄₄	S ₄₅	S ₅₁	04H	08H	0FH	10H	13H	14H	
Y ₁₉	Y Signal Maximum Input Range	A	C	A	B	A	20H	04H	80H	00H	BAH	03H	(1) Set the bus data so that black expansion is off, picture quality control is off and DC transmission compensation is minimum. (2) Input TG7 sine wave signal whose frequency is 100kHz to pin 45 (Y ₁ IN) and pin 51 (Sync. IN). (3) While increasing the amplitude V _{yd} of the signal in the video period, measure V _{yd} just before the waveform of Y ₁ output (pin 37) is distorted.

NOTE	ITEM	TEST CONDITION (Unless otherwise specified : H, RGB V _{CC} = 9V ; V _{DD} , Fsc V _{DD} , Y / C V _{CC} = 5V ; Ta = 25±3°C)										MEASURING METHOD
		SW MODE										
		S ₂₆	S ₁	S ₃₁	S ₃₃	S ₃₄	S ₃₉	S ₄₂	S ₄₄	S ₄₅	S ₅₁	
C ₁	ACC Characteristic	ON	A	B	B	B	A	A	A	A	B	<p>(1) Activate the test mode (S26-ON, Sub Add 02 ; 01h).</p> <p>(2) Set as follows : band pass filter Q = 2, f₀ = 600kHz, crystal clock = conforming to European, Asian system.</p> <p>(3) Set the gate to the normal status.</p> <p>(4) Input 3N rainbow color bar signal to pin 42 (Chroma IN).</p> <p>(5) When input signal to pin 42 is the same in the burst and chroma levels (10mV_{p-p}), burst amplitude of B-Y output signal from pin 36 is expressed as eAT. When the level of input signal to pin 42 is 100mV_{p-p} or 300mV_{p-p}, burst amplitude of the B-Y output signal is expressed as F1T or F2T. The ratio between F1T and F2T is expressed as AT. F2T / F1T = AT</p> <p>(6) Perform the same measurement in the EXT. mode (f₀ = 0). (eAE, F1E, AE)</p> <div style="text-align: right;"> </div> <p>(7) Input 4N rainbow color bar signal to pin 42 (Chroma IN), and perform the same measurement as the above-mentioned steps with 3N rainbow color bar signal input.</p>

NOTE	ITEM	TEST CONDITION (Unless otherwise specified : H, RGB $V_{CC} = 9V$; V_{DD} , Fsc V_{DD} , Y / C $V_{CC} = 5V$; $T_a = 25\pm 3^\circ C$)										MEASURING METHOD
		SW MODE										
		S ₂₆	S ₁	S ₃₁	S ₃₃	S ₃₄	S ₃₉	S ₄₂	S ₄₄	S ₄₅	S ₅₁	
C2	Band Pass Filter Characteristic	ON	A	B	B	B	A	B	A	A	B	<p>(1) Activate the test mode (S26-ON, Sub Add 02 ; 01h).</p> <p>(2) Set as follows : band pass filter Q = 2, crystal clock = conforming to 3.579 / 4.43MHz, gate = normal status.</p> <p>(3) Input 3N composite sine wave signal (1V_{p-p}) to pin 42 (Chroma IN).</p> <p>(4) Measure frequency characteristic of B-Y output of pin 36 and measure the peak frequency, too.</p> <p>(5) Changing f_o to 0, 500, 600 and 700 by the bus control and measure peak frequencies respectively with different f_o.</p> <p>(6) For measuring frequency characteristic as f_o is 4.43, use 4.43MHz crystal clock Measure the following items in the same manner.</p> <div style="display: flex; justify-content: space-around; align-items: flex-end;"> <div style="text-align: center;"> <p>$f_o = 3.58$</p> </div> <div style="text-align: center;"> <p>$f_o = 4.43$</p> </div> </div>

NOTE	ITEM	TEST CONDITION (Unless otherwise specified : H, RGB V _{CC} = 9V ; V _{DD} , Fsc V _{DD} , Y / C V _{CC} = 5V ; Ta = 25±3°C)										
		SW MODE										MEASURING METHOD
		S ₂₆	S ₁	S ₃₁	S ₃₃	S ₃₄	S ₃₉	S ₄₂	S ₄₄	S ₄₅	S ₅₁	
C ₃	Band Pass Filter, -3dB Band Characteristic	ON	A	B	B	B	A	B	A	A	B	(1) Activate the test mode (S26-ON, Sub Add 02 ; 01h). (2) Set as follows : band pass filter Q = 2, crystal clock = conforming to 3.579 / 4.43MHz. (3) Set the gate to the normal status. (4) Input 3N composite sine wave signal (1V _{p-p}) to pin 42 (Chroma IN). (5) Measure frequency characteristic of B-Y output of pin 36, and measure peak frequency in the -3dB band. (6) Changing f ₀ to 0, 500, 600 and 700 by the bus control and measure peak frequencies in the -3dB band respectively with different f ₀ .
C ₄	Band Pass Filter, Q Characteristic Check	↑	↑	↑	↑	↑	↑	↑	↑	↑	↑	(1) Activate the test mode (S26-ON, Sub Add 02 ; 01h). (2) Set as follows : TV mode (f ₀ = 600), Crystal mode = conforming to 3.579 / 4.43MHz, gate = normal status. (3) Input 3N composite sine wave signal (1V _{p-p}) to pin 42 (Chroma IN). (4) Measure frequency characteristic of B-Y output of pin 36, and measure peak frequency in the -3dB band. (5) Changing f ₀ of the band pass filter to 0, 500, 600 and 700 by the bus control and measure peak frequencies in the -3dB band respectively with different f ₀ .

NOTE	ITEM	TEST CONDITION (Unless otherwise specified : H, RGB $V_{CC} = 9V$; V_{DD} , Fsc V_{DD} , Y / C $V_{CC} = 5V$; $T_a = 25\pm 3^\circ C$)										MEASURING METHOD
		SW MODE										
		S ₂₆	S ₁	S ₃₁	S ₃₃	S ₃₄	S ₃₉	S ₄₂	S ₄₄	S ₄₅	S ₅₁	
C ₅	1 / 2 f_0 Trap Characteristic	ON	A	B	B	B	A	B	A	A	B	(1) Activate the test mode (S26-ON, Sub Add 02 ; 01h). (2) Set as follows : band pass filter Q = 2, crystal clock = conforming to 3.579 / 4.43MHz, gate = normal status. (3) Input 3N composite sine wave signal (1V _{p-p}) to pin 42 (Chroma IN). (4) Measure frequency characteristic of B-Y output of pin 36, and measure bottom frequency. (5) Changing f_0 to 0, 500, 600 and 700 by the bus control and measure bottom frequencies respectively with different f_0 .

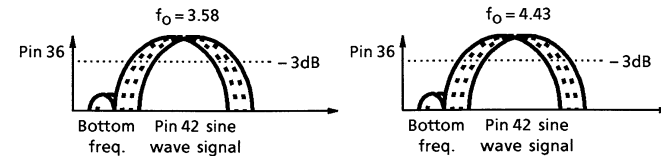

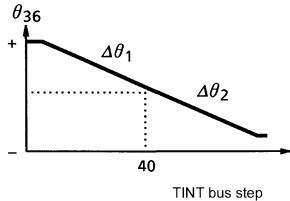
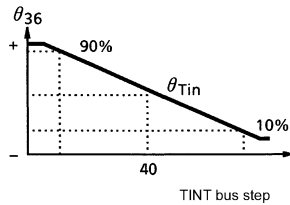
NOTE	ITEM	TEST CONDITION (Unless otherwise specified : H, RGB V _{CC} = 9V ; V _{DD} , Fsc V _{DD} , Y / C V _{CC} = 5V ; Ta = 25±3°C)										
		SW MODE										MEASURING METHOD
		S ₂₆	S ₁	S ₃₁	S ₃₃	S ₃₄	S ₃₉	S ₄₂	S ₄₄	S ₄₅	S ₅₁	
C ₆	Tint Control Sharing Range (f _o = 600kHz)	ON	A	B	B	B	A	A	A	A	B	<p>(1) Activate the test mode (S26-ON, Sub Add 02 ; 08h).</p> <p>(2) Connect band pass filter (Q = 2), set crystal mode to conform to European, Asian system and set the gate to normal status.</p> <p>(3) Input 3N rainbow color bar signal (100mV_{p-p}) to pin 42 (Chroma IN).</p> <p>(4) Measure phase shift of B-Y color difference output of pin 36.</p> <p>(5) While shifting color phase (tint) from minimum to maximum by the bus control, measure phase change of B-Y color difference output of pin 36. On the condition that 6 bars in the center have the peak level (regarded as center of color phase), the side of 5 bars is regarded as positive direction while the side of 7 bars is regarded as negative direction</p> <p>when the 5 bars or the 7 bars are in the peak level. Based on this assumption, open angle toward the positive direction is expressed as Δθ₁ and that toward the negative direction is expressed as Δθ₂ as viewed from the phase center. Δθ₁ and Δθ₂ show the tint control sharing range.</p>  <p>(6) Variable range is expressed by sum of Δθ₁ sharing range and Δθ₂ sharing range.</p> $\Delta\theta_T = \Delta\theta_1 + \Delta\theta_2$ <p>(7) While shifting color phase from minimum to maximum with the bus control, measure phase shift of B-Y color difference output of pin 36. When center 6 bars have peak level, value of color phase bus step is expressed as θ_{Tin}.</p> <p>(8) While shifting color phase from minimum to maximum with the bus control, measure values of color phase bus step corresponding to 10% and 90% of absolutely variable phase shift of B-Y color difference output of pin 36. The range of color phase shifted by the bus control is expressed as While shifting color phase from minimum to maximum with the bus control, measure phase shift of B-Y color difference output of pin 36. When center 6 bars have peak level, value of color phase bus step is expressed as Δθ_{Tin} (conforming to TV mode, f_o = 600kHz).</p>  <p>(9) Input 4N rainbow color bar signal to pin 42 (Chroma IN), and perform the same measurement as the 3N signal.</p>
C ₇	Tint Control Variable Range (f _o = 600kHz)	↑	↑	↑	↑	↑	↑	↑	↑	↑	↑	
C ₈	Tint Control Characteristic	↑	↑	↑	↑	↑	↑	↑	↑	↑	↑	

NOTE	ITEM	TEST CONDITION (Unless otherwise specified : H, RGB V _{CC} = 9V ; V _{DD} , Fsc V _{DD} , Y / C V _{CC} = 5V ; Ta = 25±3°C)										
		SW MODE										MEASURING METHOD
		S ₂₆	S ₁	S ₃₁	S ₃₃	S ₃₄	S ₃₉	S ₄₂	S ₄₄	S ₄₅	S ₅₁	
C ₉	APC Lead-In Range	OFF ↓ ON	A	B	B	B	A	A ↓ C	A	A	B	(1) Connect band pass filter (Q = 2), set to TV mode (f ₀ = 600kHz) with X'tal clock conforming to European, Asian system. (2) Set the gate to normal status. (3) Input 3N CW signal of 100mV _{p-p} to pin 42 of the chroma input terminal. (4) While changing frequency of the CW (continuous waveform) signal, measure its frequency when B-Y color difference signal of pin 36 is colored. (5) Input 4N CW (continuous waveform) 100mV _{p-p} signal to pin 42 (Chroma IN). (6) While changing frequency of the CW signal, measure frequencies when B-Y color difference output of pin 36 is colored and discolored. Find difference between the measured frequency and f _c (4.433619MHz) and express the differences as fPH and fPL, which show the APC lead-in range. (7) Variable frequency of VCXO is used to cope with lead-in of 3.582MHz / 3.575MHz PAL system. (8) Activate the test mode (S26-ON, Sub Add 02 ; 02h). (9) Input nothing to pin 42 (Chroma IN). (10) While varying voltage of pin 30 (APC Filter), measure variable frequency of VCXO at pin 35 (R-Y OUT) while observing color and discoloring of R-Y color difference signal. Express difference between the high frequency (fH) and f ₀ center as 3.582HH, and difference between the low frequency (fL) and f ₀ center as 3.582HL. Perform the same measurement for the NP system (3.575MHz PAL).
C ₁₀	APC Control Sensitivity	ON	↑	↑	↑	↑	↑	C	↑	↑	↑	(1) Activate the test mode (S26-ON, Sub Add 02 ; 02h). (2) Connect band pass filter as same as the Note C ₉ . (3) Change the X'tal mode properly to the system. (4) Input nothing to pin 42 (Chroma IN). (5) When V ₃₀ 's APC voltage ±50mV is impressed to pin 30 (APC Filter) while its voltage is being varied, measure frequency change of pin 35 output signal as frH or frL and calculate sensitivity according to the following equation. $b = (frH - frL) / 100$

NOTE	ITEM	TEST CONDITION (Unless otherwise specified : H, RGB V _{CC} = 9V ; V _{DD} , Fsc V _{DD} , Y / C V _{CC} = 5V ; Ta = 25±3°C)										
		SW MODE										MEASURING METHOD
		S ₂₆	S ₁	S ₃₁	S ₃₃	S ₃₄	S ₃₉	S ₄₂	S ₄₄	S ₄₅	S ₅₁	
C11	Killer Operation Input Level	OFF	A	B	B	B	A	A	A	A	B	(1) Connect band pass filter (Q = 2) and set to TV mode (f ₀ = 600kHz). (2) Set the crystal mode to conform to European, Asian system and set the gate to normal status. (3) Input 3N color signal having 200mV _{p-p} burst to pin 42 (Chroma IN). (4) While attenuating chroma input signal, measure input burst amplitudes of the signal when B-Y color difference output of pin 36 is discolored and when the same signal is colored. Measured input burst amplitudes shall be expressed as 3N-VTK1 and 3N-VTC1 respectively (killer operation input level). (5) Killer operation input level in the condition that P / N killer sensitivity is set to LOW with the bus control is expressed as 3N-VTK2 or 3N-VTC2. (6) Perform the same measurement as the above step 4 with different inputs of 4N, 4P, MP, NP color signals having 200mV _{p-p} burst to pin 42 (Chroma IN). (When measuring with MP / NP color signal, set the crystal system to conform to South American system.) (7) Killer operation input level at that time is expressed as follows. Normal killer operation input level in the 4N system is expressed as 4N-VTK1, 4N-VTC1. Normal killer operation input level in the 4P system is expressed as 4P-VTK1, 4P-VTC1. Killer operation input level with low killer sensitivity is expressed as 4P-VTK2, 4P-VTC2. Normal killer operation input level in the MP system is expressed as MP-VTK2, MP-VTC2. Normal killer operation input level in the NP system is expressed as NP-VTK1, NP-VTC1. Killer operation input level with low killer sensitivity is expressed as NP-VTK2, NP-VTC2. [Reference] 3N system : 3.579545MHz NTSC 4N system : 4.433619MHz False NTSC 4P system : 4.433619MHz PAL MP system : 3.575611MHz M-PAL NP system : 3.582056MHz N-PAL

NOTE	ITEM	TEST CONDITION (Unless otherwise specified : H, RGB V _{CC} = 9V ; V _{DD} , Fsc V _{DD} , Y / C V _{CC} = 5V ; Ta = 25±3°C)										
		SW MODE										MEASURING METHOD
		S ₂₆	S ₁	S ₃₁	S ₃₃	S ₃₄	S ₃₉	S ₄₂	S ₄₄	S ₄₅	S ₅₁	
C ₁₂	Color Difference Output	ON	A	B	B	B	A	A	A	A	B	(1) Activate the test mode (S26-ON, Sub Add 02 ; 08h). (2) Connect band pass filter (Q = 2), set to TV mode (f ₀ = 600kHz) with 0dB attenuation. (3) Set the crystal mode to conform to European, Asian system and set the gate to normal status. (4) Input 3N, 4N and 4P rainbow color bar signals having 100mV _{p-p} burst to pin 42 of the chroma input terminal one after another. (5) Measure amplitudes of color difference signals of pin 36 (B-Y) and pin 35 (R-Y) respectively, and express them as 3NeB-Y / R-Y, 4NeB-Y / R-Y and 4PeB-Y / R-Y respectively. (6) While inputting 4P 75% color bar signal (100mV _{p-p} burst) to pin 42 of the chroma input terminal, measure amplitudes of color difference signals of pin 36 (B-Y OUT) and pin 35 (R-Y OUT) respectively. (Ratio of those amplitudes is expressed as 4Peb-y / r-y for checking color level of SECAM system.)
C ₁₃	Demodulation Relative Amplitude	↑	↑	↑	↑	↑	↑	↑	↑	↑	↑	(1) Activate the test mode (S26-ON, Sub Add 02 ; 08h). (2) Connect band pass filter (Q = 2), set to TV mode (f ₀ = 600kHz) with 0dB attenuation. (3) Set the crystal mode to conform to European, Asian system and set the gate to normal status. (4) Input 3N, 4N and 4P rainbow color bar signals having 100mV _{p-p} burst to pin 42 of the chroma input terminal one after another. (5) Measure amplitudes of color difference signals of pin 36 (B-Y) and pin 35 (R-Y) respectively, and express ratio between the two amplitudes as 3NG R / B, 4NG R / B and 4PG R / B respectively. (Note) Relative amplitude of G-Y color difference signal shall be checked later in the Text section.

NOTE	ITEM	TEST CONDITION (Unless otherwise specified : H, RGB V _{CC} = 9V ; V _{DD} , Fsc V _{DD} , Y / C V _{CC} = 5V ; Ta = 25±3°C)										
		SW MODE										MEASURING METHOD
		S ₂₆	S ₁	S ₃₁	S ₃₃	S ₃₄	S ₃₉	S ₄₂	S ₄₄	S ₄₅	S ₅₁	
C14	Demodulation Relative Phase	ON	A	B	B	B	A	A	A	A	B	(1) Activate the test mode (S26-ON, Sub Add 02 ; 08h). (2) Connect band pass filter (Q = 2), set to TV mode (f ₀ = 600kHz) with 0dB attenuation. (3) Set the crystal mode to conform to European, Asian system and set the gate to normal status. (4) Input 3N, 4N and 4P rainbow color bar signals having 100mV _{p-p} burst to pin 42 of the chroma input terminal one after another. (5) Measure phases of color difference signals of pin 36 (B-Y) and pin 35 (R-Y) respectively, and express them as 3NθR-B, 4NθR-B and 4PθR-B respectively. (6) For measuring with 3N and 4N color bar signals in NTSC system, set six bars of the B-Y color difference waveform to the peak level with the Tint control and measure its phase difference from phase of R-Y color difference signal of pin 35 (R-Y OUT). (Note) Relative phase of G-Y color difference signal shall be checked later in the Text section.
C15	Demodulation Output Residual Carrier	↑	↑	↑	↑	↑	↑	↑	↑	↑	↑	(1) Activate the test mode (S26-ON, Sub Add 02 ; 08h). (2) Connect band pass filter (Q = 2), set to TV mode (f ₀ = 600kHz) with 0dB attenuation. (3) Set the crystal mode to conform to European, Asian system. (4) Set the gate to normal status. (5) Input 3N and 4N rainbow color bar signals having 100mV _{p-p} burst to pin 42 of the chroma input terminal one after another. (6) Measure subcarrier leak of 3N and 4N color bar signals appearing in color difference signals of pin 36 (B-Y OUT) and pin 35 (R-Y OUT) respectively, and express those leaks as 3N-SCB / R and 4N-SCB / R.

NOTE	ITEM	TEST CONDITION (Unless otherwise specified : H, RGB V _{CC} = 9V ; V _{DD} , Fsc V _{DD} , Y / C V _{CC} = 5V ; Ta = 25±3°C)										
		SW MODE										MEASURING METHOD
		S ₂₆	S ₁	S ₃₁	S ₃₃	S ₃₄	S ₃₉	S ₄₂	S ₄₄	S ₄₅	S ₅₁	
C ₁₆	Demodulation Output Residual Higher Harmonic	ON	A	B	B	B	A	A	A	A	B	(1) Activate the test mode (S26-ON, Sub Add 02 ; 08h). (2) Connect band pass filter (Q = 2), set to TV mode (f ₀ = 600kHz) with 0dB attenuation. (3) Set the crystal mode to conform to European, Asian system and set the gate to normal status. (4) Input 3N and 4N rainbow color bar signals having 100mV _{p-p} burst to pin 42 of the chroma input terminal one after another. (5) Measure higher harmonic (2f _c = 7.16MHz or 8.87MHz) of 3N and 4N color bar signals appearing in color difference signals of pin 36 (B-Y OUT) and pin 35 (R-Y OUT) respectively, and express them as 3N-HCB / R and 4N-HCB / R.
C ₁₇	Color Difference Output ATT Check	↑	↑	↑	↑	↑	↑	↑	↑	↑	↑	(1) Activate the test mode (S26-ON, Sub Add 02 ; 08h). (2) Connect band pass filter (Q = 2) and set bus data for the TV mode (f ₀ = 600kHz). (3) Set the X'tal clock mode to conform to European, Asian system and set the gate to normal status. (4) Input 3N rainbow color bar signal whose burst is 100mV _{p-p} to pin 42 of the chroma input terminal. (5) Measure amplitude of color difference output signal of pin 36 (B-Y OUT) with 0dB attenuation set by the bus control. Set the amplitude of the color difference output of pin 36 (B-Y OUT) to 0dB, and measure amplitude of the same signal with different attenuation of -2dB, -1dB and +1dB set by the bus control.

NOTE	ITEM	TEST CONDITION (Unless otherwise specified : H, RGB V _{CC} = 9V ; V _{DD} , Fsc V _{DD} , Y / C V _{CC} = 5V ; Ta = 25±3°C)														OTHER CONDITION	MEASURING METHOD	
		S	BUS : TEST MODE							BUS : NORMAL CONTROL MODE								
			02H				07H			10H								
			D ₅	D ₂	D ₁	D ₀	D ₇	D ₄	D ₃	D ₅	D ₄	D ₃	D ₂	D ₁	D ₀			
C ₁₈	16.2MHz Oscillation Frequency	ON	0	0	0	1	0	0	0	0	0	0	0	0	0	0	—	(1) Input nothing to pin 42. (2) Measure frequency of CW signal of pin 35 as fr, and find oscillation frequency by the following equation. $\Delta f_o F = (fr - 0.05MHz) \times 4$
C ₁₉	16.2MHz Oscillation Start Voltage	ON	0	0	0	1	0	0	0	0	0	0	0	0	0	0	Impress pin 38 individually with separate power supply.	While raising voltage of pin 38, measure voltage when oscillation waveform appears at pin 40.
C ₂₀	f _{sc} Free-Run Frequency	ON	0	0	0	1	0	0	0	0	Variable			0	0	—	(1) Input nothing to pin 42. (2) Change setting of SUB (10H) D ₄ , D ₃ and D ₂ according to respective frequency modes, and measure frequency of CW signal of pin 35. Detail of D ₄ , D ₃ and D ₂ 3.58M = 1 : (001), 4.43M = 2 : (010) M-PAL = 6 : (110), N-PAL = 7 : (111)	
C ₂₁	f _{sc} Output Amplitude	OFF	0	0	0	0	0	0	0	0	0	1	1	0	0	—	(1) Input nothing to pin 42. (2) Change setting of SUB (10H) D ₄ , D ₃ and D ₂ according to respective frequency modes. Measure the amplitude of output signal of pin 27.	



DEF SECTION

NOTE	ITEM	TEST CONDITION (Unless otherwise specified : H, RGB V _{CC} = 9V ; V _{DD} , Fsc V _{DD} , Y / C V _{CC} = 5V ; Ta = 25±3°C ; BUS = preset value ;) pin 51 input video signal = 50 system (Note) "x" in the data column represents preset value at power ON.										
		SUB-ADDRESS & BUS DATA										MEASURING METHOD
DH1	H. Reference Frequency	Sub 02H	0	0	0	0	0	0	0	0	1	(1) Supply 5V to pin 26. (2) Set bus data as indicated on the left. (3) Measure the frequency of sync. output of pin 49.
DH2	H. Reference Oscillation Start Voltage	Sub 02H	0	0	0	0	0	0	0	0	1	In the test condition of the Note DH1, turning down the voltage supplied to pin 26 from 5V, measure the voltage when oscillation of pin 49 stops.
DH3	H. Output Frequency 1	Sub 10H	x	x	x	x	x	x	0	0	1	(1) Set bus data as indicated on the left. (2) In the condition of the above step 1, measure frequency (TH1) at pin 4.
DH4	H. Output Frequency 2	Sub 10H	x	x	x	x	x	x	1	0	0	(1) Set the input video signal of pin 51 to the 60 system. (2) Set bus data as indicated on the left. (3) In the above-mentioned condition, measure frequency (TH2) at pin 4.
DH5	H. Output Duty 1	—	—	—	—	—	—	—	—	—	—	(1) Supply 4.5V DC to pin 5 (or, make pin 5 open-circuited). (2) Measure duty of pin 4 output.
DH6	H. Output Duty 2	—	—	—	—	—	—	—	—	—	—	(1) Make a short circuit between pin 5 and ground. (2) Measure duty of pin 4 output.
DH7	H. Output Duty Switching Voltage	—	—	—	—	—	—	—	—	—	—	Supply 2V DC to pin 5. While turning down the voltage from 2V, measure voltage when the output duty ratio becomes 41 to 37%.
DH8	H. Output Voltage	—	—	—	—	—	—	—	—	—	—	Measure the low voltage and high voltage of pin 4 output whose waveform is shown below. 
DH9	H. Output Oscillation Start Voltage	—	—	—	—	—	—	—	—	—	—	While raising H. V _{CC} (pin 3) from 0V, measure voltage when pin 4 starts oscillation.

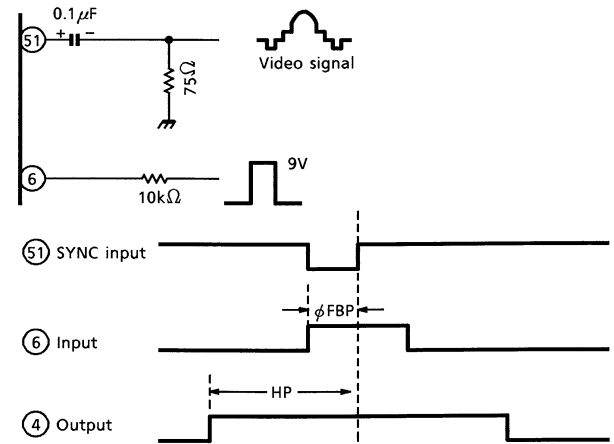
NOTE	ITEM	TEST CONDITION									
		[Unless otherwise specified : H, RGB $V_{CC} = 9V$; V_{DD} , Fsc V_{DD} , Y / C $V_{CC} = 5V$; $T_a = 25 \pm 3^\circ C$; BUS = preset value ;]									
		(Note) "x" in the data column represents preset value at power ON.									
SUB-ADDRESS & BUS DATA										MEASURING METHOD	
DH10	H. FBP Phase										(1) Supply 4.5V DC to pin 5. (2) Input video signal to pin 51. (3) Set the width of pin 6 input pulse to 8 μ s. (4) Measure ϕ FBP shown in the figure below (ϕ FBP). (5) Adjust the phase of pin 6 input pulse so that the center of pin 4's output pulse corresponds to the trailing edge of input sync. signal.
DH11	H. Picture Position, Maximum										(6) Set bus data as indicated on the left and measure the horizontal picture position with respective bus data settings (HSFTmax, HSFTmin). (7) Find HP difference between the conditions mentioned in the above step 6 (Δ HSFT). (8) Reset bus data to the preset value.
DH12	H. Picture Position, Minimum	Sub 0BH	0	0	0	0	0	x	x	x	(9) While impressing 5V DC to pin 5, measure HP. (10) While impressing 4V DC to pin 5, measure HP. (11) Find difference between the two measurement results obtained in the preceding steps 9 and 10 (Δ HCC).
DH13	H. Picture position Control Range		1	1	1	1	1	x	x	x	
DH14	H. Distortion Correction Control Range										

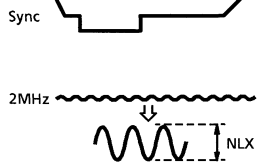
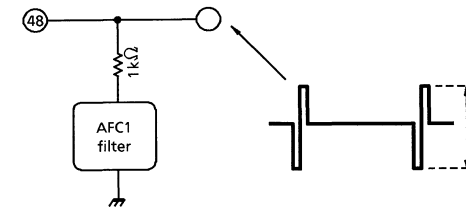

NOTE	ITEM	TEST CONDITION									
		[Unless otherwise specified : H, RGB V _{CC} = 9V ; V _{DD} , Fsc V _{DD} , Y / C V _{CC} = 5V ; Ta = 25±3°C ; BUS = preset value ;]									
		(Note) "x" in the data column represents preset value at power ON.									
		SUB-ADDRESS & BUS DATA					MEASURING METHOD				
DH15	H. BLK Phase	Sub02H	0	0	0	0	0	1	0	0	(1) In the condition of the steps 1 through 4 of the Note DH10, perform the following measurement.
DH16	H. BLK Width, Minimum	Sub 16H	0	0	0	x	x	x	x	x	(2) Supply 5V DC to pin 26.
DH17	H. BLK Width, Maximum		1	1	1	x	x	x	x	x	(3) Set bus data as indicated on the left. (4) Measure phase difference between pin 51 and pin 49 as shown below. (5) Change the bus data as shown on the left and measure BLK width.
DH18	P / N-GP Start Phase 1	Sub 0FH	x	x	x	x	0	x	x	x	(1) Supply 5V to pin 26.
DH19	P / N-GP Start Phase 2		x	x	x	x	1	x	x	x	(2) Set bus data as indicated on the left.
DH20	P / N-GP Gate Width 1		x	x	x	x	1	x	x	x	(3) With the respective bus data settings mentioned above, measure the phase and gate width as shown in the figure below.
DH21	P / N-GP Gate Width 2		x	x	x	x	1	x	x	x	
DH22	SECAM-GP Start Phase 1	Sub 1FH	x	x	x	0	x	x	x	x	(1) Supply 5V to pin 26.
DH23	SECAM-GP Start Phase 2		x	x	x	1	x	x	x	x	(2) Set bus data as indicated on the left.
DH24	SECAM-GP Gate Width 1		x	x	x	1	x	x	x	x	(3) With the respective bus data settings mentioned above, measure the phase and gate width as shown in the figure below.
DH25	SECAM-GP Gate Width 2		x	x	x	1	x	x	x	x	

NOTE	ITEM	TEST CONDITION									
		[Unless otherwise specified : H, RGB V _{CC} = 9V ; V _{DD} , Fsc V _{DD} , Y / C V _{CC} = 5V ; Ta = 25±3°C ; BUS = preset value ;]									
		(Note) "x" in the data column represents preset value at power ON.									
SUB-ADDRESS & BUS DATA										MEASURING METHOD	
DH26	Noise Detection Level 1	Sub 1DH									(1) Input such a signal as shown by "a" of the following figure to pin 51. (2) Set bus data as indicated in the first line of the left table. (3) Measure NLX when amplitude of pin 41 changes. → NL1
DH27	Noise Detection Level 2		0	0	x	x	x	x	x	x	(4) Set bus data as indicated in the second line of the left table. (5) Measure NLX when amplitude of pin 41 changes. → NL2
DH28	Noise Detection Level 3		0	1	x	x	x	x	x	x	(6) Set bus data as indicated in the third line of the left table. (7) Measure NLX when amplitude of pin 41 changes. → NL3
DH29	Noise Detection Level 4		1	0	x	x	x	x	x	x	(8) Set bus data as indicated in the fourth line of the left table. (9) Measure NLX when amplitude of pin 41 changes. → NL4
			1	1	x	x	x	x	x	x	 
DV1	V. Ramp Amplitude	—	—	—	—	—	—	—	—	—	(1) Measure amplitude of V. ramp waveform of pin 52.
											
DV2	V. NF Maximum Amplitude	Sub 17H	1	1	1	1	1	1	1	x	(1) Set data bus as indicated on the left. (2) Measure amplitude of pin 54's signal.
DV3	V. NF Minimum Amplitude	Sub 17H	0	0	0	0	0	0	0	x	(1) Set data bus as indicated on the left. (2) Measure amplitude of pin 54's signal.

NOTE	ITEM	TEST CONDITION (Unless otherwise specified : H, RGB $V_{CC} = 9V$; V_{DD} , Fsc V_{DD} , Y / C $V_{CC} = 5V$; $T_a = 25 \pm 3^\circ C$; BUS = preset value ;) pin 51 input video signal = 50 system (Note) "x" in the data column represents preset value at power ON.										
		SUB-ADDRESS & BUS DATA										MEASURING METHOD
DV4	V. Amplification Degree											(1) Set bus data as indicated on the left. (2) Change 5.0V of pin 54 voltage by +0.1V and -0.1V, and measure V_{53} output voltage in both the conditions. (3) Find GVA shown in the figure below. (4) Measure V_{vmax} and V_{vmin} shown in the figure below.
DV5	V. Amplifier Max. Output	Sub 1BH	1	1	x	x	x	x	x	x		
DV6	V. Amplifier Min. Output											
DV7	V. S-Curve Correction, Max. Correction Quantity	Sub 19H	1	1	1	1	1	1	1	x	(1) Adjust the oscilloscope's amplitude with the UNCAL so that pin 52 and pin 54 waveforms overlap each other as the bus data is set to the preset value. (2) Change the bus data as indicated on the left, and measure values of X and Y shown in the figure below. (3) Find V_S according to the equation that $V_S = (X / Y) \times 100\%$.	

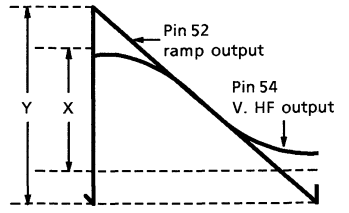
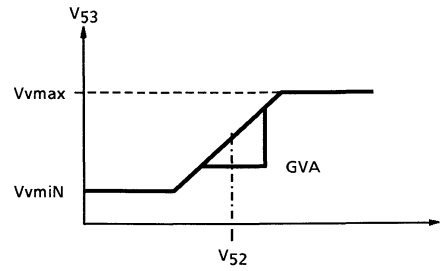

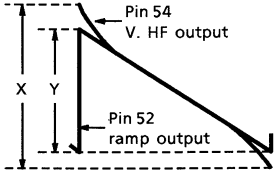
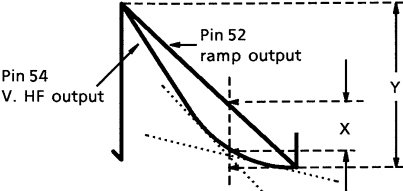
NOTE	ITEM	TEST CONDITION									
		[Unless otherwise specified : H, RGB $V_{CC} = 9V$; V_{DD} , Fsc V_{DD} , Y / C $V_{CC} = 5V$; $T_a = 25\pm 3^\circ C$; BUS = preset value ;]									
		(Note) "x" in the data column represents preset value at power ON.									
SUB-ADDRESS & BUS DATA										MEASURING METHOD	
DV8	V. Reverse S-Curve Correction, Max. Correction Quantity	Sub 19H	0	0	0	0	0	0	0	x	<p>(1) Adjust the oscilloscope's amplitude with the UNCAL so that pin 52 and pin 54 waveforms overlap each other as the bus data is set to the preset value.</p> <p>(2) Change the bus data as indicated on the left, and measure values of X and Y shown in the figure below.</p> <p>(3) Find V_S according to the equation that $V_S = (X / Y) \times 100\%$.</p> 
DV9	V. Linearity Max. Correction Quantity	Sub 1AH	1	1	1	1	1	x	x	x	<p>(1) Adjust the oscilloscope's amplitude with the UNCAL so that pin 52 and pin 54 waveforms overlap each other as the bus data is set to the preset value.</p> <p>(2) Change the bus data as indicated on the left, and measure values of X and Y shown in the figure below.</p> <p>(3) Find V_S according to the equation that $V_S = (X / 2Y) \times 100\%$.</p> 

NOTE	ITEM	TEST CONDITION (Unless otherwise specified : H, RGB V _{CC} = 9V ; V _{DD} , Fsc V _{DD} , Y / C V _{CC} = 5V ; Ta = 25±3°C ; BUS = preset value ;) pin 51 input video signal = 50 system (Note) "x" in the data column represents preset value at power ON.										
		SUB-ADDRESS & BUS DATA										
		MEASURING METHOD										
DV10	AFC-MASK Start Phase											(1) Supply 5V DC to pin 26. (2) Set bus data as indicated on the left and activate the test mode. (3) Measure the AFC-MASK start phase (X) and AFC-MASK stop phase (Y) of pin 49. (4) Set the Sub 16H as indicated on the left. (5) Measure the VNFB start phase (Z) of pin 54.
DV11	AFC-MASK Stop Phase	Sub 02H	0	0	0	0	0	0	0	0	1	
		Sub 16H	x	x	x	x	x	0	0	0	0	
DV12	VNFB Phase											
DV13	V. Output Maximum Phase											(1) Input video signal to pin 51. (2) Measure both phases (Xmax, Xmin) of pin 52 and pin 54 with the respective bus data settings shown on the left. (3) Find difference between the two phases measured in the above step 2. $Y = X_{max} - X_{min}$
DV14	V. Output Minimum Phase	Sub 16H	x	x	x	x	x	0	0	0		
			x	x	x	x	x	1	1	1		
DV15	V. Output Phase Variable Range											

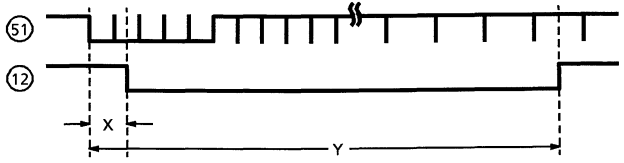
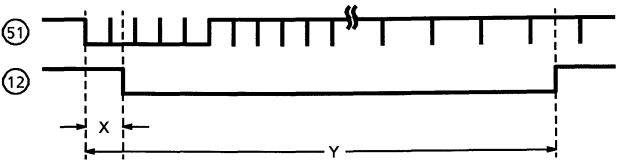
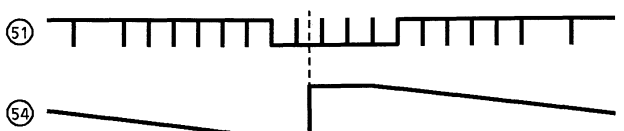
NOTE	ITEM	TEST CONDITION (Unless otherwise specified : H, RGB V _{CC} = 9V ; V _{DD} , Fsc V _{DD} , Y / C V _{CC} = 5V ; Ta = 25±3°C ; BUS = preset value ;) pin 51 input video signal = 50 system										
		(Note) "x" in the data column represents preset value at power ON.										
		SUB-ADDRESS & BUS DATA										MEASURING METHOD
DV16	50 System VBLK Start Phase	Sub 1BH	0	1	x	x	x	x	x	x	x	(1) Input such a video signal of the 50 system as shown in the figure to pin 51. (2) Set bus data as indicated on the left. (3) Measure the VBLK start phase (X) and VBLK stop phase (Y) of pin 12.
DV17	50 System VBLK Stop Phase	Sub 1CH	0	x	x	x	x	x	x	x		
DV18	60 System VBLK Start Phase	Sub 1BH	0	1	x	x	x	x	x	x	(1) Input such a video signal of the 60 system as shown in the figure to pin 51. (2) Set bus data as indicated on the left. (3) Measure the VBLK start phase (X) and VBLK stop phase (Y) of pin 12.	
DV19	60 System VBLK Stop Phase	Sub 1CH	0	x	x	x	x	x	x	x		
DV20	V. Lead-In Range 1	Sub 16H	x	x	x	0	0	0	0	0	(1) Set bus data as indicated on the left. (2) Input 262.5 H video signal to pin 51. (3) Set a certain number of field lines in which signals of pin 51 and pin 54 completely synchronize with each other as shown in the figure below. (4) Decrease the field lines in number and measure number of lines in which pin 51 and pin 54 signals do not synchronize with each other. (5) Again set a certain number of field lines in which pin 51 and pin 52 signals synchronize with each other. (6) Increase the field lines in number and measure number of lines in which pin 51 and pin 52 signals do not synchronize with each other.	
												

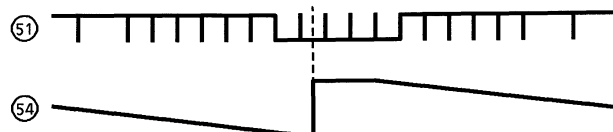
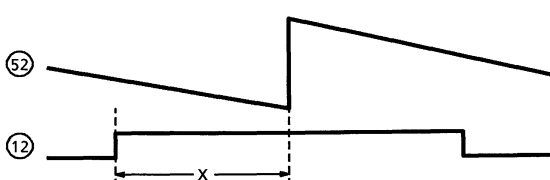
NOTE	ITEM	TEST CONDITION (Unless otherwise specified : H, RGB V _{CC} = 9V ; V _{DD} , Fsc V _{DD} , Y / C V _{CC} = 5V ; Ta = 25±3°C ; BUS = preset value ;) pin 51 input video signal = 50 system (Note) "x" in the data column represents preset value at power ON.										
		SUB-ADDRESS & BUS DATA										MEASURING METHOD
DV21	V. Lead-In Range 2	Sub 16H	x	x	x	0	1	0	0	0	0	(1) Set bus data as indicated on the left. (2) Input 262.5 H video signal to pin 51. (3) Set a certain number of field lines in which signals of pin 51 and pin 54 completely synchronize with each other as shown in the figure below. (4) Decrease the field lines in number and measure number of lines in which pin 51 and pin 54 signals do not synchronize with each other. (5) Again set a certain number of field lines in which pin 51 and pin 52 signals synchronize with each other. (6) Increase the field lines in number and measure number of lines in which pin 51 and pin 52 signals do not synchronize with each other. 
DV22	W-VBLK Start Phase	Sub 1BH	x	x	0	0	0	0	0	0	(1) Set bus data as specified for the Sub 1BH in the left columns, and measure the value of X shown in the figure below. W-VBLK start phase : MAX, MIN	
DV23	W-PMUTE Start Phase	Sub 1DH	x	x	1	1	1	1	1	1	(2) Set bus data as specified for the Sub 1DH in the left columns, and measure the value of X shown in the figure below. W-PMUTE start phase : MAX, MIN 	
			x	x	0	0	0	0	0	0	(Note) Only the 60 system is subject to evaluation.	

NOTE	ITEM	TEST CONDITION [Unless otherwise specified : H, RGB V _{CC} = 9V ; V _{DD} , Fsc V _{DD} , Y / C V _{CC} = 5V ; Ta = 25±3°C ; BUS = preset value ;]									
		(Note) "x" in the data column represents preset value at power ON.									
		SUB-ADDRESS & BUS DATA								MEASURING METHOD	
DV24	W-VBLK Stop Phase	Sub 1CH	x	0	0	0	0	0	0	(1) Set bus data as specified for the Sub 1CH in the left columns, and measure the value of Y shown in the figure below. W-VBLK stop phase : MAX, MIN (2) Set bus data as specified for the Sub 1EH in the left columns, and measure the value of Y shown in the figure below. W-PMUTE stop phase : MAX, MIN 	
DV25	W-PMUTE Stop Phase	Sub 1EH	x	1	1	1	1	1	1		
	(Note) Only the 60 system is subject to evaluation.	Sub 1EH	x	0	0	0	0	0	0		
		Sub 1EH	x	1	1	1	1	1	1		
DV26	V Centering Center Voltage		1	0	0	0	0	0	x	x	(1) Set bus data as indicated on the left. (2) Measure the voltage of pin 47 with respective bus data settings.
DV27	V Centering Max Voltage	Sub 18H	1	1	1	1	1	1	x	x	
DV28	V Centering Min Voltage		0	0	0	0	0	0	x	x	

1H DL SECTION

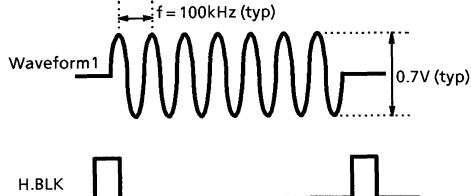
NOTE	ITEM	TEST CONDITION (Unless otherwise specified : H, RGB $V_{CC} = 9V$; V_{DD} , Fsc V_{DD} , Y / C $V_{CC} = 5V$; $T_a = 25 \pm 3^\circ C$; BUS = preset value ; pin3 = 9V ; pin8 · 38 · 41 = 5V)				
		SW MODE	SUB ADDRESS & DATA			MEASURING METHOD
		S26	07H	0FH	11H	
H ₁	1HDL Dynamic Range Direct	ON	94H	—	—	<p>(1) Input waveform 1 to pin 33 (B · Yin) , and measure VNBD, that pin 36 (B · Yout) is saturated input level.</p> <p>(2) Measure VNRD of R · Y input in the same way as VNBD.</p> 
H ₂	1HDL Dynamic Range Delay	↑	8CH	—	—	<p>(1) Input waveform 1 to pin 33 (B-Yin), and measure VPBD, that pin 36 (B-Yout) is saturated input level.</p> <p>(2) Measure VPRD of R-Y input in the same way as VPBD.</p>
H ₃	1HDL Dynamic Range, Direct+Delay	↑	A4H	—	—	<p>(1) Input waveform 1 to pin 33 (B-Yin), and measure VSBD, that pin 36 (B-Yout) is saturated input level.</p> <p>(2) Measure VNRD of R-Y input in the same way as VSBD.</p>
H ₄	Frequency Characteristic, Direct	↑	94H	—	—	<p>(1) In the same measuring as H₁, set waveform 1 to 0.3V_{p-p} and f = 100kHz. Measure VB100, that is pin 36 (B-Yout) level. And set waveform 1 to f = 700kHz. Measure VB700, that is pin 36 (B-Yout) level.</p> <p style="text-align: center;">$GHB1 = 20 \log (VB700 / VB100)$</p> <p>(2) Measure GHR1 of R-Y out in the same way as GHB1.</p>
H ₅	Frequency Characteristic, Delay	↑	8CH	—	—	<p>(1) In the same measuring as H₁, set waveform 1 to 0.3V_{p-p} and f = 100kHz. Measure VB100, that is pin 36 (B-Yout) level. And set waveform 1 to f = 700kHz. Measure VB700, that is pin 36 (B-Yout) level.</p> <p style="text-align: center;">$GHB2 = 20 \log (VB700 / VB100)$</p> <p>(2) Measure GHR2 of R-Y out in the same way as GHB2. Measure VB700, that is pin 36 (B-Yout) level.</p>
H ₆	AC Gain Direct	↑	94H	—	—	<p>(1) In the same measuring as H₁, set waveform 1 to 0.7V_{p-p}. Measure VByt1, that is pin 36 (B-Yout) level.</p> <p style="text-align: center;">$GBY_1 = 20 \log (VByt1 / 0.7)$</p> <p>(2) Measure GRY1 of R-Y out in the same way as GBY1.</p>
H ₇	AC Gain Delay	↑	8CH	—	—	<p>(1) In the same measuring as H₁, set waveform 1 to 0.7V_{p-p}. Measure VByt2, that is pin 36 (B-Yout) level.</p> <p style="text-align: center;">$GBY_2 = 20 \log (VByt2 / 0.7)$</p> <p>(2) Measure GRY2 of R-Y out in the same way as GBY2.</p>

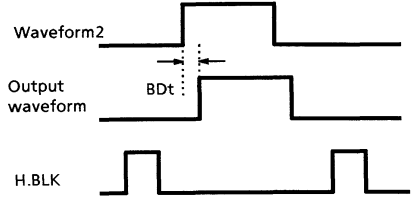
NOTE	ITEM	TEST CONDITION (Unless otherwise specified : H, RGB V _{CC} = 9V ; V _{DD} , Fsc V _{DD} , Y / C V _{CC} = 5V ; Ta = 25±3°C ; BUS = preset value ; pin3 = 9V ; pin8 · 38 · 41 = 5V)				
		SW MODE	SUB ADDRESS & DATA			MEASURING METHOD
			S26	07H	0FH	
H ₈	Direct · Delay AC Gain Difference	ON	94H 8CH	—	—	(1) GBYD = GBY1 – GBY2 (2) GRYD = GRY1 – GRY2
H ₉	Color Difference Output DC Stepping	↑	8CH	—	—	(1) Measure pin 36 (B-Yout) DC stepping of the picture period. (2) Measure pin 35 (R-Yout) DC stepping of the picture period.
H ₁₀	1H Delay Quantity	↑	8CH	—	—	(1) Input waveform 2 to pin 33 (B-Yin). And measure the time deference BDt of pin 36 (B-Yout). (2) Input waveform 2 to pin 34 (R-Yin). And measure the time difference RDt of pin 36 (B-Yout). 
H ₁₁	Color Difference Output DC-Offset Control	↑	8CH	20H	00H 88H FFH	(1) Set Sub-Address 11h ; data 88h. Measure the pin 36 DC voltage, that is BDC1. (2) Set Sub-Address 11h ; data 88h. Measure the pin 35 DC voltage, that is RDC1. (3) Set Sub-Address 11h ; data 00h. Measure the pin 36 DC voltage, that is BDC2. (4) Set Sub-Address 11h ; data 00h. Measure the pin 35 DC voltage, that is RDC2. (5) Set Sub-Address 11h ; data FFh. Measure the pin 36 DC voltage, that is BDC3. (6) Set Sub-Address 11h ; data FFh. Measure the pin 35 DC voltage, that is RDC3. (7) Bomin = BDC2 – BDC1, Bomax = BDC3 – BDC1, Romin = RDC2 – RDC1, Romax = RDC3 – RDC1
H ₁₂	Color Difference Output DC-Offset Control / Min. Control Quantity	↑	A4H	00H	89H	(1) Measure the pin 36 DC voltage, that is BDC4. (2) Measure the pin 35 DC voltage, that is RDC4. (3) Bo1 = BDC4 – BDC1, Ro1 = RDC4 – RDC1
H ₁₃	NTSC Mode Gain / NTSC-COM Gain	↑	94H	80H	—	(1) Input waveform 1, that is set 0.3V _{p-p} and f = 100kHz, to pin 33. Measure pin 36 output level, that is VBNC. (2) GNB = 20log (VBNC / VB100) (3) In the same way as (1) and (2), measure the pin 36 output level, that is VRNC. GNR = 20log (VRNC / VR100)

TEXT SECTION

NOTE	ITEM	TEST CONDITION (Unless otherwise specified : H, RGB $V_{CC} = 9V$; V_{DD} , Fsc V_{DD} , Y / C $V_{CC} = 5V$; $T_a = 25\pm 3^\circ C$; BUS = preset value)															
		SW MODE							SUB-ADDRESS & BUS DATA							MEASURING METHOD	
		S ₂₁	S ₂₂	S ₃₁	S ₃₃	S ₃₄	S ₅₁	—	—	—	00H	02H	—	—	—		—
T ₁	Y Color Difference Clamping Voltage	B	B	B	B	B	A	—	—	—	FFH	00H	—	—	—	—	<ol style="list-style-type: none"> Short circuit pin 31 (Y IN), pin 34 (R-Y IN) and pin 33 (B-Y IN) in AC coupling. Input 0.3V synchronizing signal to pin 51 (Sync IN). Measure voltage at pin 31, pin 34 and pin 33 (V_{cp31}, V_{cp34}, V_{cp33}).
T ₂	Contrast Control Characteristic	↑	↑	↑	↑	↑	↑	—	—	—	FFH 80H 00H	00H	—	—	—	—	<ol style="list-style-type: none"> Input TG7 sine wave signal whose frequency is 100kHz and video amplitude is 0.7V to pin 31 (Y IN). Input 0.3V Synchronizing Signal to pin 51 (Sync IN). Connect both pin 21 (Digital Ys) and pin 22 (Analog Ys) to ground. Set bus data so that Y sub contrast and drive are set at each center value and color is minimum. Varying data on contrast from maximum (FF) to minimum (00), measure maximum and minimum amplitudes of respective outputs of pin 14 (R OUT), pin 13 (G OUT) and pin 12 (B OUT) in video period, and read values of bus data at the same time. Find ratio between amplitude with maximum unicolor and that with minimum unicolor in conversion into decibel (ΔV_{13ct}). <p>Also, measure the respective amplitudes with the bus data set to the center value (80).</p> <p>(V_{c12mx}, V_{c12mn}, D12c80) (V_{c13mx}, V_{c13mn}, D13c80) (V_{c14mx}, V_{c14mn}, D14c80)</p>
T ₃	AC Gain	↑	↑	↑	↑	↑	↑	—	—	—	—	—	—	—	—	—	<p>In the test condition of Note T₂, find output / input gain (double) with maximum contrast.</p> <p>$G = V_{c13mx} / 0.7V$</p>

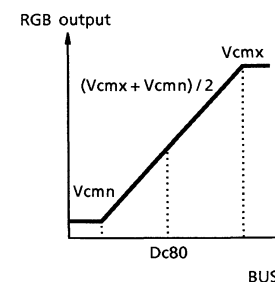

NOTE	ITEM	TEST CONDITION (Unless otherwise specified : H, RGB V _{CC} = 9V ; V _{DD} , Fsc V _{DD} , Y / C V _{CC} = 5V ; Ta = 25±3°C ; BUS = preset value)															
		SW MODE							SUB-ADDRESS & BUS DATA							MEASURING METHOD	
		S ₂₁	S ₂₂	S ₃₁	S ₃₃	S ₃₄	S ₅₁	—	—	—	00H	02H	—	—	—		—
T ₄	Frequency Characteristic	B	B	B	B	B	A	—	—	—	FFH	00H	—	—	—	—	(1) Input TG7 sine wave signal whose frequency is 6MHz and video amplitude is 0.7V to pin 31 (Y IN). (2) Input 0.3V synchronizing signal to pin 51 (Sync IN). (3) Connect both pin 21 (Digital Ys) and pin 22 (Analog Ys) to ground. (4) Set bus data so that contrast is maximum, Y sub contrast and drive are set at each center value and color is minimum. (5) Measure amplitude of pin 13 signal (G OUT) and find the output / input gain (double) (G6M). (6) From the results of the above step 5 and the Note T ₃ , find the frequency characteristic. $G_f = 20 \log (G6M / G)$

NOTE	ITEM	TEST CONDITION (Unless otherwise specified : H, RGB V _{CC} = 9V ; V _{DD} , Fsc V _{DD} , Y / C V _{CC} = 5V ; Ta = 25±3°C ; BUS = preset value)															
		SW MODE									SUB-ADDRESS & BUS DATA						MEASURING METHOD
		S ₂₁	S ₂₂	S ₃₁	S ₃₃	S ₃₄	S ₅₁	S ₄₂	—	—	00H	02H	05H	1BH	08H	—	
T ₅	Y Sub-Contrast Control Characteristic	B	B	B	B	B	A	—	—	—	FFH	00H	1FH 00H	—	—	—	(1) Connect both pin 21 (Digital Ys) and pin 22 (Analog Ys) to ground. (2) Input TG7 sine wave signal whose frequency is 100kHz and video amplitude is 0.7V to pin 31 (Y IN). (3) Input 0.3V synchronizing signal to pin 51 (Sync IN). (4) Set bus data so that contrast is maximum, drive is set at center value and color is minimum. (5) Set bus data on Y sub contrast at maximum (FF) and measure amplitude (Vscmx) of pin 14 output (R OUT). Then, set data on Y sub contrast at minimum (00), measure the same (Vscmn). (6) From the results of the above step 5, find ratio between Vscmx and Vscmn in conversion into decibel (ΔVscnt).
T ₆	Y ₂ Input Level	↑	↑	↑	↑	↑	↑	—	—	—	↑	—	—	BFH	44H	—	(1) Set bus data so that contrast is maximum, Y sub contrast and drive are at each center value. (2) Input 0.3V synchronizing signal to pin 51 while inputting TG7 sine wave signal whose frequency is 100kHz to pin 31 (TY IN). (3) While increasing the amplitude of the sine wave signal, measure video amplitude of signal 1 just before R output of pin 14 is distorted. (Vy2d)

NOTE	ITEM	TEST CONDITION (Unless otherwise specified : H, RGB V _{CC} = 9V ; V _{DD} , Fsc V _{DD} , Y / C V _{CC} = 5V ; Ta = 25±3°C ; BUS = preset value)																
		SW MODE								SUB-ADDRESS & BUS DATA							MEASURING METHOD	
		S ₂₁	S ₂₂	S ₃₁	S ₃₃	S ₃₄	S ₅₁	S ₄₂	—	—	00H	02H	05H	1BH	08H	—		
T ₇	Unicolor Control Characteristic	B	B	B	B	B	A	—	—	—	FFH	80H	—	—	BFH	—	—	(1) Input 0.3V synchronizing signal to pin 51 (Sync IN). (2) Input 100kHz, 0.3V _{p-p} sine wave signal to both pin 33 (B-Y IN) and pin 34 (R-Y IN). (3) Connect pin 21 (Digital Ys) and pin 22 (Analog Ys) to ground. (4) Set bus data so that drive is at center value and Y mute is on. (5) While changing bus data on unicolor from maximum (FF) to minimum (00), measure maximum and minimum amplitudes of pin 13 (G OUT) and pin 12 (B OUT) in video period respectively, and read the bus data together with. Also, measure respective amplitudes as unicolor data is set at center value (80). $(V_{n12mx}, V_{n12mn}, D12n80)$ $(V_{n13mx}, V_{n13mn}, D13n80)$ $(V_{n14mx}, V_{n14mn}, D14n80)$ (6) Find ratio between amplitude with maximum unicolor data and that with minimum unicolor data in conversion into decibel ($\Delta V13un$).
T ₈	Relative Amplitude (NTSC)	↑	↑	A	A	A	↑	A	—	—	FFH	—	—	↑	—	—	While inputting rainbow color bar signal (3.58MHz for NTSC) to pin 42 and 0.3V synchronizing signal to pin 51 so that video amplitude of pin 33 is 0.38V _{p-p} , find the relative amplitude $(Mnr-b = Vu14mx / Vu12mx, Mng-b = Vu13mx / Vu12mx)$.	
T ₉	Relative Phase (NTSC)	↑	↑	↑	↑	↑	↑	↑	—	—	↑	—	—	↑	—	—	(1) In the test condition of the Note T ₈ , adjust bus data on tint so that output of pin 12 (B OUT) has the peak level in the 6th bar. (2) Regarding the phase of pin 12 (B OUT) as a reference phase, find comparative phase differences of pin 14 (R OUT) and pin 13 (G OUT) from the reference phase respectively ($\theta nr-b, \theta ng-b$).	

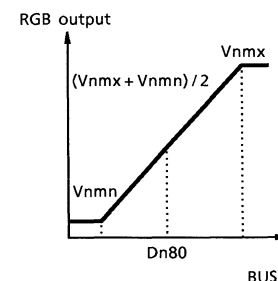

NOTE	ITEM	TEST CONDITION (Unless otherwise specified : H, RGB V _{CC} = 9V ; V _{DD} , Fsc V _{DD} , Y / C V _{CC} = 5V ; Ta = 25±3°C ; BUS = preset value)															
		SW MODE								SUB-ADDRESS & BUS DATA							MEASURING METHOD
		S ₂₁	S ₂₂	S ₃₁	S ₃₃	S ₃₄	S ₅₁	S ₄₂	—	—	00H	02H	1BH	—	—	—	
T ₁₀	Relative Amplitude (PAL)	B	B	A	A	A	A	A	—	—	FFH	—	BFH	—	—	—	While inputting rainbow color bar signal (4.43MHz for PAL) to pin 42 and 0.3V synchronizing signal to pin 51 so that video amplitude of pin 33 is 0.38V _{p-p} , find the relative amplitude. (Mpr-b = Vu14mx / Vu12mx, Mpg-b = Vu13mx / Vu12mx)
T ₁₁	Relative Phase (PAL)	↑	↑	↑	↑	↑	↑	↑	—	—	↑	—	—	—	—	—	(1) In the test condition of the Note T ₁₀ , adjust bus data on tint so that output of pin 12 (B OUT) has the peak level in the 6th bar. (2) Regarding the phase of pin 12 (B OUT) as a reference phase, find comparative phase differences of pin 14 (R OUT) and pin 13 (G OUT) from the reference phase respectively (θpr-b, θpg-b).
T ₁₂	Color Control Characteristic	↑	↑	B	B	B	↑	—	—	—	↑	FFH	↑	—	—	—	(1) Input 0.3V synchronizing signal to pin 51 (Sync IN). (2) Input 100kHz, 0.1V _{p-p} sine wave signal to both pin 33 (B-Y IN) and pin 34 (R-Y IN). (3) Connect pin 21 (Digital Ys) and pin 22 (Analog Ys) to ground. (4) Set bus data so that unicolor is maximum, drive is at center value and Y mute is on. (5) Measure amplitude of pin 12 (B OUT) as bus data on color is set maximum (FF). (V _{cmx}) (6) Read bus data when output level of pin 12 is 10%, 50% and 90% of V _{cmx} respectively (Dc10, Dc50, Dc90).
T ₁₃	Color Control Characteristic, Residual Color	↑	↑	↑	↑	↑	↑	—	—	—	↑	00H	↑	—	—	—	(7) From results of the above step 6, calculate number of steps from Dc10 to Dc90 (Δcol) and that from 00 to Dc50 (ecol). (8) Measure respective amplitudes of pin 12 (B OUT), pin 13 (G OUT) and pin 14 (R OUT) with color data set at minimum, and regard the results as color residuals (ecb, ecg, ecr).

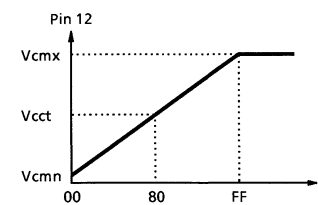

NOTE	ITEM	TEST CONDITION (Unless otherwise specified : H, RGB V _{CC} = 9V ; V _{DD} , Fsc V _{DD} , Y / C V _{CC} = 5V ; Ta = 25±3°C ; BUS = preset value)															
		SW MODE								SUB-ADDRESS & BUS DATA							MEASURING METHOD
		S ₂₁	S ₂₂	S ₃₁	S ₃₃	S ₃₄	S ₅₁	S ₄₂	—	—	00H	02H	1BH	—	—	—	
T ₁₄	Chroma Input Range	B	B	A	A	A	A	A	—	—	FFH	88H	BFH	—	—	—	(1) Input rainbow color bar signal (3.58MHz for NTSC or 4.43MHz for PAL) to pin 42 (C IN) and 0.3V synchronizing signal to pin 51 (Sync IN). (2) Connect pin 36 (B-Y OUT) and pin 33 (B-Y IN), pin 35 (R-Y OUT) and pin 34 (R-Y IN) in AC coupling respectively. (3) Connect pin 21 (Digital Ys) and pin 22 (Analog Ys) to ground. (4) Set bus data so that unicolor is maximum, drive and color are set at each center value (80) and mute is on. (5) While increasing amplitude of chroma signal input to pin 42, measure amplitude just before any of pin 12 (B OUT), pin 13 (G OUT) and pin 14 (R OUT) output signals is distorted (Vcr).

NOTE	ITEM	TEST CONDITION (Unless otherwise specified : H, RGB V _{CC} = 9V ; V _{DD} , Fsc V _{DD} , Y / C V _{CC} = 5V ; Ta = 25±3°C ; BUS = preset value)																
		SW MODE						SUB-ADDRESS & BUS DATA						MEASURING METHOD				
		S ₂₁	S ₂₂	S ₃₁	S ₃₃	S ₃₄	S ₅₁	—	—	—	00H	05H	—		—	—	—	
T ₁₅	Brightness Control Characteristic	B	B	B	B	B	A	—	—	—	FFH	00H	10H	—	—	—	—	(1) Short circuit pin 31 (Y IN), pin 33 (B-Y IN) and pin 34 (R-Y IN) in AC coupling. (2) Input 0.3V synchronizing signal to pin 51 (Sync IN). (3) Set bus data so that R, G, B cut off data are set at center value. (4) Connect pin 21 (Digital Ys) and pin 22 (Analog Ys) to ground.
T ₁₆	Brightness Center Voltage	↑	↑	↑	↑	↑	↑	—	—	—	80H	↑	—	—	—	—	—	(5) While changing bus data on brightness from maximum to minimum, measure video voltage of pin 13 (G OUT) to find maximum and minimum voltages (max : V _{brmx} , min : V _{brmn}). (6) With bus data on brightness set at center value, measure video voltage of pin 13 (G OUT) (V _{bcnt}).
T ₁₇	Brightness Data Sensitivity	↑	↑	↑	↑	↑	↑	—	—	—	—	—	—	—	—	—	—	(7) On the condition that bus data with which V _{brmx} is obtained in measurement of the above step 5 is D _{brmx} and bus data with which V _{brmn} is obtained in measurement of the above step 5 is D _{brmn} , calculate sensitivity of brightness data (ΔV _{brt}). $\Delta V_{brt} = (V_{brmxg} - V_{brmng}) / (D_{brmxg} - D_{brmng})$
T ₁₈	RGB Output Voltage Axes Difference	↑	↑	↑	↑	↑	↑	—	—	—	—	—	—	—	—	—	—	(1) In the same manner as the Note T ₁₆ , measure video voltage of pin 12 (B OUT) with bus data on brightness set at center value. (2) Find maximum axes difference in the brightness center voltage.
T ₁₉	White Peak Limit Level	↑	↑	↑	↑	↑	↑	—	—	—	00H	1FH	—	—	—	—	—	(1) Set bus data so that contrast and Y sub contrast are maximum and brightness is minimum. (2) Input TG7 sine wave signal whose frequency is 100kHz and amplitude in video period is 0.9V to pin 31 (Y IN). (3) Connect pin 21 (Digital Ys) and pin 22 (Analog Ys) to ground. (4) While turning on / off WPL with bus, measure video amplitude of pin 14 (R OUT) with WPL being activated (V _{wpl}).

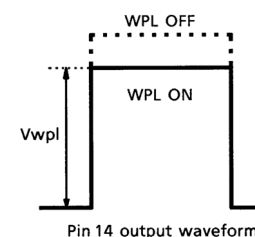

NOTE	ITEM	TEST CONDITION (Unless otherwise specified : H, RGB V _{CC} = 9V ; V _{DD} , Fsc V _{DD} , Y / C V _{CC} = 5V ; Ta = 25±3°C ; BUS = preset value)																	
		SW MODE						SUB-ADDRESS & BUS DATA						MEASURING METHOD					
		S ₂₁	S ₂₂	S ₃₁	S ₃₃	S ₃₄	S ₅₁	—	—	—	09H	0AH	0CH				0DH	0EH	—
T ₂₀	Cutoff Control Characteristic	B	B	B	B	B	A	—	—	—	80H	80H	FFH	FFH	FFH	—	(1) Short circuit pin 31 (Y IN), pin 33 (B-Y IN) and pin 34 (R-Y IN) in AC coupling. (2) Input 0.3V synchronizing signal to pin 51 (Sync IN). (3) Connect pin 21 (Digital Ys) and pin 22 (Analog Ys) to ground. (4) Set bus data on brightness at center value. (5) While changing data on cutoff from maximum to minimum, measure video voltage of pin 13 (G OUT) to find maximum and minimum values (max : Vcomx, min : Vcomn). (6) Set cutoff data at center value and measure video voltage of pin 13 (G OUT) (Vcoct). (7) On the condition that bus data with which Vcomx is obtained in measurement of the above step 5 is Dcomx and bus data with which Vcomn is obtained in the same is Dcomn, calculate number of steps (ΔDcut). $\Delta Dcut = Dcomx - Dcomn$		
T ₂₁	Cutoff Center Level	↑	↑	↑	↑	↑	↑	—	—	—	↑	↑	80H	80H	80H	—			
T ₂₂	Cutoff Variable Range	↑	↑	↑	↑	↑	↑	—	—	—	—	—	—	—	—	—			
T ₂₃	Drive Variable Range	↑	↑	↑	↑	↑	↑	—	—	—	FFH	FFH	00H	00H	80H	80H	80H	—	(1) Short circuit pin 33 (B-Y IN) and pin 34 (R-Y IN) in AC coupling. (2) Input a stepping signal whose amplitude in video period is 0.3V to pin 31 (Y IN). (3) Input 0.3V synchronizing signal to pin 51 (Sync IN). (4) Connect pin 21 (Digital Ys) and pin 22 (Analog Ys) to ground. (5) Set bus data so that contrast is maximum and Y sub contrast is minimum. (6) While changing drive data from minimum to maximum, measure video amplitude of pin 13 (G OUT) to find maximum and minimum values (max : Vdrmx, min : Vdrmn). (7) Set drive data at center value and measure video amplitude of pin 13 (G OUT) (Vdrct). Calculate amplitude ratio of the measured value to the maximum and minimum amplitudes measured in the above step 6 respectively (DR+, DR-).

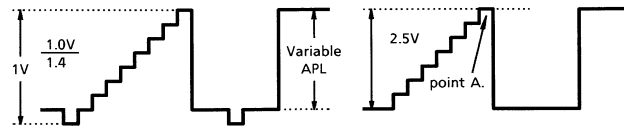
NOTE	ITEM	TEST CONDITION (Unless otherwise specified : H, RGB V _{CC} = 9V ; V _{DD} , Fsc V _{DD} , Y / C V _{CC} = 5V ; Ta = 25±3°C ; BUS = preset value)															
		SW MODE						SUB-ADDRESS & BUS DATA						MEASURING METHOD			
		S ₂₁	S ₂₂	S ₃₁	S ₃₃	S ₃₄	S ₅₁	S ₄₅	S ₃₉	S ₄₄	—	—	—			—	—
T ₂₄	DC Regeneration	B	B	A	B	B	A	B	A	A	—	—	—	—	—	—	<ol style="list-style-type: none"> Short circuit pin 33 (B-Y IN) and pin 34 (R-Y IN) in AC coupling. Input such the step-up signal as shown below to pin 45 (Y IN) and pin 51 (Sync IN). Connect pin 21 (Digital Ys) and pin 22 (Analog Ys) to ground. Set bus data so that contrast is maximum and DC transmission correction factor is minimum. Adjust data on Y sub contrast so that video amplitude of pin 13 (G OUT) is 2.5V. While varying APL of the step-up signal from 10% to 90%, measure change in voltage at the point A. 
T ₂₅	RGB Output S / N Ratio	↑	↑	B	↑	↑	↑	—	—	—	—	—	—	—	—	—	<ol style="list-style-type: none"> Short circuit pin 31 (Y IN), pin 33 (B-Y IN) and pin 34 (R-Y IN) in AC coupling. Input synchronizing signal of 0.3V in amplitude to pin 51 (Sync IN). Connect pin 21 (Digital Ys) and pin 22 (Analog Ys) to ground. Set bus data on contrast at maximum. Set bus data on Y sub contrast at center value. Measure video noise level of pin 13 (G OUT) with oscilloscope (no). $SNo = -20\log(2.5 / (1 / 5) \times no)$

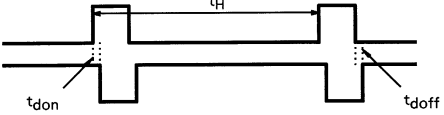
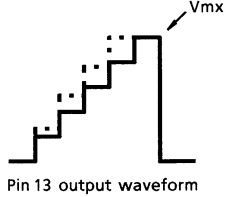
NOTE	ITEM	TEST CONDITION (Unless otherwise specified : H, RGB V _{CC} = 9V ; V _{DD} , Fsc V _{DD} , Y / C V _{CC} = 5V ; Ta = 25±3°C ; BUS = preset value)															
		SW MODE						SUB-ADDRESS & BUS DATA						MEASURING METHOD			
		S ₂₁	S ₂₂	S ₃₁	S ₃₃	S ₃₄	S ₅₁	—	—	—	01H	05H	08H				0CH
T ₂₆	Blanking Pulse Output Level	B	B	B	B	B	A	—	—	—	80H	10H	04H	80H	80H	80H	(1) Input synchronizing signal of 0.3V in amplitude to pin 51 (Sync IN) (2) Connect pin 21 (Digital Ys) and pin 22 (Analog Ys) to ground. (3) Set bus data so that blanking is on. (4) Measure voltage of pin 13 (G OUT) in V. blanking period (Vv). (5) Measure voltage of pin 13 (G OUT) in H. blanking period (Vh).
T ₂₇	Blanking Pulse Delay Time	↑	↑	↑	↑	↑	↑	—	—	—	↑	↑	↑	↑	↑	↑	In the setting condition of the Note T ₂₆ , find "t _{don} " and "t _{doff} " (see figure below) between the signal impressed to pin 6 (BFP IN) and output signal of pin 13 (G OUT). 
T ₂₈	RGB Min. Output Level	↑	↑	↑	↑	↑	↑	—	—	—	00H	↑	↑	00H	00H	00H	(1) Short circuit pin 31 (Y IN), pin 33 (B-Y IN) and pin 34 (R-Y IN) in AC coupling. (2) Input synchronizing signal of 0.3V in amplitude to pin 51 (Sync IN). (3) Connect pin 21 (Digital Ys) and pin 22 (Analog Ys) to ground. (4) Set bus data so that brightness and RGB cutoff are minimum. (5) Measure video voltage of pin 13 (G OUT) (Vmn).
T ₂₉	RGB Max. Output Level	↑	↑	↑	↑	↑	↑	—	—	—	80H	1fH	44H	80H	80H	80H	(1) Short circuit pin 33 (B-Y IN) and pin 34 (R-Y IN) in AC coupling. (2) Input stepping signal to pin 31 (Y IN) and synchronizing signal of 0.3V in amplitude to pin 51 (Sync IN). (3) Connect pin 21 (Digital Ys) and pin 22 (Analog Ys) to ground. (4) Set bus data so that contrast and Y sub contrast are maximum. (5) While increasing amplitude of the stepping signal, measure maximum output level just before video signal of pin 13 (G OUT) is distorted (Vmx). 

NOTE	ITEM	TEST CONDITION (Unless otherwise specified : H, RGB V _{CC} = 9V ; V _{DD} , Fsc V _{DD} , Y / C V _{CC} = 5V ; Ta = 25±3°C ; BUS = preset value)															
		SW MODE									SUB-ADDRESS & BUS DATA						MEASURING METHOD
		S ₁₈	S ₁₉	S ₂₀	S ₂₁	S ₂₂	S ₃₁	S ₃₃	S ₃₄	S ₅₁	15H	1CH	—	—	—	—	
T ₃₀	Halftone Ys Level	B	B	B	A	B	B	B	B	A	00H	80H	—	—	—	—	(1) Input stepping signal whose amplitude is 0.3V in video period to pin 31 (Y IN) and pin 51 (Sync IN). (2) Set bus data so that blanking is off and halftone is -3dB in on status. (3) Connect power supply to pin 21 (Digital Ys). While impressing 0V to it, measure amplitude and pedestal level of pin 13 (G OUT) in video period (V _{m13} , V _{p13}). (4) Raising supply voltage to pin 21 gradually from 0V, measure level (V _{tht1}) of pin 21 when amplitude of pin 13 output signal changes. At the same time, measure amplitude and pedestal level of pin 13 in video period after the pin 13 output signal changed in amplitude. (V _{m13b} , V _{p13b}) (5) According to results of the above steps 3 and 4, calculate gain of -3dB halftone and variation of pedestal level. $G_{3ht13} = 20 \log (V_{m13b} / V_{m13})$ (6) Set bus data so that halftone is -6dB in on status, and perform the same measurement as the above steps 4 and 5 to find gain of -6dB halftone and variation of pedestal level (G _{6ht13}). (7) Raising supply voltage to pin 21 further from V _{tht1} , measure level (V _{tx1}) of pin 21 when output signal of pin 13 (G OUT) changes in amplitude and DC level of pin 13 after the change of its output (V _{tx13}). (8) From results of the above steps 3 and 7, calculate low level of the output in the text mode. $V_{tx13} = V_{tx13} - V_{p13}$ (9) Raising supply voltage to pin 21 by 3V from that in the above step 7, confirm that there is no change in output level of pin 13.
T ₃₁	Halftone Gain 1	↑	↑	↑	↑	↑	↑	↑	↑	↑	↑	↑	—	—	—	—	
T ₃₂	Halftone Gain 2	↑	↑	↑	↑	↑	↑	↑	↑	↑	01H	↑	—	—	—	—	
T ₃₃	Text ON Ys, Low Level	↑	↑	↑	↑	↑	↑	↑	↑	↑	↑	↑	—	—	—	—	
T ₃₄	Text / OSD Output, Low Level	↑	↑	↑	↑	↑	↑	↑	↑	↑	↑	↑	—	—	—	—	

NOTE	ITEM	TEST CONDITION (Unless otherwise specified : H, RGB V _{CC} = 9V ; V _{DD} , Fsc V _{DD} , Y / C V _{CC} = 5V ; Ta = 25±3°C ; BUS = preset value)														MEASURING METHOD	
		SW MODE									SUB-ADDRESS & BUS DATA						
		S18	S19	S20	S21	S22	S31	S33	S51	—	15H	1CH	—	—	—		—
T35	Text RGB Output, High Level	A	A	A	A	B	B	B	A	—	02H	80H	—	—	—	—	(1) Input stepping signal whose amplitude is 0.3V in video period to pin 31 (Y IN) and pin 51 (Sync IN). (2) Set bus data so that blanking and halftone are off. (3) Connect power supply to pin 21 (Digital Ys). While impressing 0V to it, measure pedestal level of pin 13 output signal (G OUT) (Vpl13). (4) Connect power supply to pin 19 (Digital G IN) and impress it with 2V.
T36	OSD Ys ON, Low Level	↑	↑	↑	↑	↑	↑	↑	↑	—	↑	↑	—	—	—	—	(5) Raising supply voltage to pin 21 gradually from 0V, measure video level of pin 21 after output signal of pin 13 changed (Vlx13). (6) From measurement results of the above steps 3 and 5, calculate high level in the text mode. $V_{mt13} = V_{tx13} - V_{pt13}$
T37	OSD RGB Output, High Level	↑	↑	↑	↑	↑	↑	↑	↑	—	↑	↑	—	—	—	—	(7) Raising supply voltage to pin 21 further from that in the step 5, measure level (Vtost) of pin 21 when the level of pin 13 output signal changes from that in the step 5 to -6dB as halftone data is set to ON (the 6th step of Notes T30 to T34). (8) In the condition of the above step 7, raise voltage impressed to pin 19 to 3V and measure output voltage of pin 13 (Vos13). (9) From results of the above steps 3 and 7, calculate high level of the output in the OSD mode. $V_{mos13} = V_{os13} - V_{pt13}$

NOTE	ITEM	TEST CONDITION (Unless otherwise specified : H, RGB V _{CC} = 9V ; V _{DD} , Fsc V _{DD} , Y / C V _{CC} = 5V ; Ta = 25±3°C ; BUS = preset value)															
		SW MODE					SUB-ADDRESS & BUS DATA					MEASURING METHOD					
		S ₁₈	S ₁₉	S ₂₀	S ₂₁	S ₂₂	S ₃₁	S ₃₃	S ₃₄	S ₅₁	—					—	—
T ₃₈	Text Input Threshold Level	A	A	A	A	B	B	B	B	A	—	—	—	—	—	—	(1) Connect power supply to pin 21 (Digital Ys) and impress 1.5V to it. (2) Connect power supply to pin 19 (Digital G IN). While raising supply voltage gradually from 0V, measure supply voltage when output signal of pin 13 (G OUT) changes (V _{txt}). (3) Raising the supply voltage to pin 19 furthermore to 4V, confirm that there is no change in the output signal of pin 13 (G OUT).
T ₃₉	OSD Input Threshold Level	↑	↑	↑	↑	↑	↑	↑	↑	↑	—	—	—	—	—	—	(1) Connect power supply to pin 21 (Digital Ys) and impress 2.5V to it. (2) Connect power supply to pin 19 (Digital G IN). While raising supply voltage gradually from 0V, measure supply voltage when output signal of pin 13 (G OUT) changes (V _{osd}). (3) Raising the supply voltage to pin 19 furthermore to 4V, confirm that there is no change in the output signal of pin 13 (G OUT).

NOTE	ITEM	TEST CONDITION (Unless otherwise specified : H, RGB V _{CC} = 9V ; V _{DD} , Fsc V _{DD} , Y / C V _{CC} = 5V ; Ta = 25±3°C ; BUS = preset value)															
		SW MODE									SUB-ADDRESS & BUS DATA					MEASURING METHOD	
		S18	S19	S20	S21	S22	S31	S33	S34	S51	—	—	—	—	—		—
T40	OSD Mode Switching Rise-Up Time	A	A	A	A	B	B	B	B	A	—	—	—	—	—	—	<p>(1) Input a Signal Shown by (a) in the following figure to pin 21 (Digital Ys).</p> <p>(2) According to (b) in the figure, measure t_{ROsd}, t_{PROs}, t_{FOsd} and t_{PFos} for output signals of pin 14 (R OUT), pin 13 (G OUT) and pin 12 (B OUT) respectively.</p> <p>(3) Find maximum values of t_{PROs} and t_{PFos} respectively (Δt_{PROs}, Δt_{PFos}).</p>
T41	OSD Mode Switching Rise-Up Transfer Time	↑	↑	↑	↑	↑	↑	↑	↑	↑	—	—	—	—	—	—	
T42	OSD Mode Switching Rise-Up Transfer Time, 3 Axes Difference	↑	↑	↑	↑	↑	↑	↑	↑	↑	—	—	—	—	—	—	
T43	OSD Mode Switching Breaking Time	↑	↑	↑	↑	↑	↑	↑	↑	↑	—	—	—	—	—	—	
T44	OSD Mode Switching Breaking Transfer Time	↑	↑	↑	↑	↑	↑	↑	↑	↑	—	—	—	—	—	—	
T45	OSD Mode Switching Breaking Transfer Time, 3 Axes Difference	↑	↑	↑	↑	↑	↑	↑	↑	↑	—	—	—	—	—	—	

NOTE	ITEM	TEST CONDITION (Unless otherwise specified : H, RGB $V_{CC} = 9V$; V_{DD} , Fsc V_{DD} , Y / C $V_{CC} = 5V$; $T_a = 25 \pm 3^\circ C$; BUS = preset value)															
		SW MODE									SUB-ADDRESS & BUS DATA					MEASURING METHOD	
		S18	S19	S20	S21	S22	S31	S33	S34	S51	—	—	—	—	—		—
T46	OSD Hi DC Switching Rise-Up Time	A	A	A	A	B	B	B	B	A	—	—	—	—	—	—	<p>(1) Supply pin 21 (Digital Ys) with 2.5V.</p> <p>(2) Input 5V_{p-p} signal shown by (a) in the figure to pin 18 (Digital R IN).</p> <p>(3) Referring to (b) of the following figure, measure t_{R0sh}, t_{PRoh}, t_{F0sh} and t_{PFoh} for output signal of pin 14 (R OUT).</p> <p>(4) Input 5V_{p-p} signal shown by (a) in the figure to pin 19 (Digital G IN).</p> <p>(5) Perform the same measurement as the above step 3 for pin 13 output (G OUT) referring to (b) of the following figure.</p> <p>(6) Input 5V_{p-p} signal shown by (a) in the figure to pin 20 (Digital B IN).</p> <p>(7) Perform the same measurement as the above step 3 for pin 12 output (B OUT) referring to (b) of the following figure.</p> <p>(8) Find maximum axes differences in t_{PRoh} and t_{PFoh} among the three outputs (Δt_{PRoh}, Δt_{PFoh}).</p>
T47	OSD Hi DC Switching Rise-Up Transfer Time	↑	↑	↑	↑	↑	↑	↑	↑	↑	—	—	—	—	—	—	
T48	OSD Hi DC Switching Rise-Up Transfer Time, 3 Axes Difference	↑	↑	↑	↑	↑	↑	↑	↑	↑	—	—	—	—	—	—	
T49	OSD Hi DC Switching Breaking Time	↑	↑	↑	↑	↑	↑	↑	↑	↑	—	—	—	—	—	—	
T50	OSD Hi DC Switching Breaking Transfer Time	↑	↑	↑	↑	↑	↑	↑	↑	↑	—	—	—	—	—	—	
T51	OSD Hi DC Switching Breaking Transfer Time, 3 Axes Difference	↑	↑	↑	↑	↑	↑	↑	↑	↑	—	—	—	—	—	—	

NOTE	ITEM	TEST CONDITION (Unless otherwise specified : H, RGB V _{CC} = 9V ; V _{DD} , Fsc V _{DD} , Y / C V _{CC} = 5V ; Ta = 25±3°C ; BUS = preset value)																	
		SW MODE							SUB-ADDRESS & BUS DATA							MEASURING METHOD			
		S ₂₁	S ₂₂	S ₃₁	S ₃₃	S ₃₄	S ₅₁	—	—	—	06H	—	—	—	—				
T ₅₂	RGB Contrast Control Characteristic	B	A	B	B	B	A	—	—	—	FFH	80H	00H	—	—	—	—	—	<ol style="list-style-type: none"> Input 0.3V synchronizing signal to pin 51 (Sync IN). Supply 5V of external supply voltage to pin 22 (Analog Ys). Set bus data on drive at center value. Input TG7 sine wave signal (f = 100kHz, video amplitude = 0.5V) to pin 23 (Analog R IN). While changing data on RGB contrast from maximum (FF) to minimum (00), measure maximum and minimum amplitudes of pin 14 (R OUT) in video period. At the same time, measure video amplitude of pin 14 when the bus data is set at the center value (80). (V_{c14mx}, V_{c14mn}, D14c80) In the same manner as the above steps 4 and 5, measure output signal of pin 13 with input of the same external power supply to pin 24 (Analog G IN), and measure output signal of pin 12 with input of the same power supply to pin 25 (Analog B IN). (V_{c12mx}, V_{c12mn}, D12c80). Find amplitude ratio between signal with maximum unicolor data and signal with minimum unicolor data in conversion into decibel (ΔV13ct).

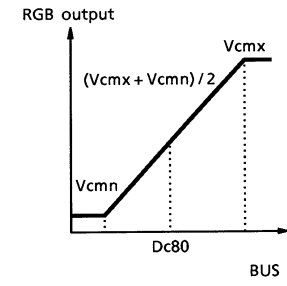

NOTE	ITEM	TEST CONDITION (Unless otherwise specified : H, RGB V _{CC} = 9V ; V _{DD} , Fsc V _{DD} , Y / C V _{CC} = 5V ; Ta = 25±3°C ; BUS = preset value)															
		SW MODE							SUB-ADDRESS & BUS DATA								MEASURING METHOD
		S ₂₁	S ₂₂	S ₃₁	S ₃₃	S ₃₄	S ₅₁	—	—	—	06H	—	—	—	—	—	
T ₅₃	Analog RGB AC Gain	B	A	B	B	B	A	—	—	—	—	—	—	—	—	In the setting condition of the Note T ₅₂ , calculate output / input gain (double) with contrast data being set maximum. G = Vc13mx / 0.5V	
T ₅₄	Analog RGB Frequency Characteristic	↑	↑	↑	↑	↑	↑	—	—	—	FFH	—	—	—	—	(1) Input 0.3V synchronizing signal to pin 51 (Sync IN). (2) Supply 5V of external supply voltage to pin 22 (Analog Ys). (3) Input TG7 sine wave signal (f = 100kHz, video amplitude = 0.5V) to pin 24 (Analog G IN). (4) Set bus data so that contrast is maximum and drive is set at center value. (5) Measure video amplitude of pin 13 (G OUT) and calculate output / input gain (double) (G6M). (6) From measurement results of the above step 5 and the preceding Note 53, find frequency characteristic. Gf = 20log (G6M / G)	

NOTE	ITEM	TEST CONDITION (Unless otherwise specified : H, RGB V _{CC} = 9V ; V _{DD} , Fsc V _{DD} , Y / C V _{CC} = 5V ; Ta = 25±3°C ; BUS = preset value)															
		SW MODE							SUB-ADDRESS & BUS DATA								MEASURING METHOD
		S ₂₁	S ₂₂	S ₃₁	S ₃₃	S ₃₄	S ₅₁	—	—	—	01H	06H	—	—	—	—	
T ₅₅	Analog RGB Dynamic Range	B	A	B	B	B	A	—	—	—	—	00H	—	—	—	—	(1) Input 0.3V synchronizing signal to pin 51 (Sync IN). (2) Supply 5V of external supply voltage to pin 22 (Analog Ys). (3) Set bus data so that contrast is minimum and drive is set at center value. (4) While inputting stepping signal to pin 24 (Analog G IN), increase video amplitude gradually from 0. (5) Measure video amplitude of pin 24 when video voltage of pin 13 (G OUT) does not change.
T ₅₆	RGB Brightness Control Characteristic	↑	↑	↑	↑	↑	↑	—	—	—	FFH 00H	—	—	—	—	—	(1) Short circuit pin 31 (Y IN), pin 33 (B-Y IN) and pin 34 (R-Y IN) in AC coupling. (2) Input 0.3V synchronizing signal to pin 51 (Sync IN). (3) Set bus data on RGB cutoff at center value. (4) Supply 5V of external supply voltage to pin 22 (Analog Ys).
T ₅₇	RGB Brightness Center Voltage	↑	↑	↑	↑	↑	↑	—	—	—	80H	—	—	—	—	—	(5) While changing data brightness from maximum to minimum, measure maximum and minimum voltages of pin 13 (G OUT) in video period. (max : V _{brmx} , min : V _{brmn}) (6) Set bus data on brightness at center value and measure video voltage of pin 13 (G OUT) (V _{bcnt}).
T ₅₈	RGB Brightness Data Sensitivity	↑	↑	↑	↑	↑	↑	—	—	—	—	—	—	—	—	—	(7) On the condition that bus data with which V _{brmx} is obtained in measurement of the above step 5 is D _{brmx} and bus data with which V _{brmn} is obtained in measurement of the above step 5 is D _{brmn} , calculate sensitivity of brightness data (ΔV _{brt}). ΔV _{brt} = (V _{brmx} - V _{brmn}) / (D _{brmx} - D _{brmn})
T ₅₉	Analog RGB Mode ON Voltage	↑	↑	↑	↑	↑	↑	—	—	—	80H	—	—	—	—	—	(1) Input TG7 sine wave signal (f = 100kHz, video amplitude = 0.3V) to pin 23 (Analog R IN). (2) Supply 5V of external supply voltage to pin 22 (Analog Ys) and raise the voltage gradually from 0V. (3) Measure voltage at pin 22 when signal 1 is output from pin 14 (R OUT) (V _{anath}).

NOTE	ITEM	TEST CONDITION (Unless otherwise specified : H, RGB V _{CC} = 9V ; V _{DD} , Fsc V _{DD} , Y / C V _{CC} = 5V ; Ta = 25±3°C ; BUS = preset value)														
		SW MODE							SUB-ADDRESS & BUS DATA							MEASURING METHOD
		S ₂₁	S ₂₂	S ₃₁	S ₃₃	S ₃₄	S ₅₁	—	—	—	—	—	—	—	—	
T ₆₀	Analog RGB Switching Rise-Up Time	B	A	B	B	B	A	—	—	—	—	—	—	—	—	(1) Supply signal (2V _{p-p}) shown by (a) in the following figure to pin 22 (Analog Ys). (2) Referring to (b) of the following figure, measure τ _{Rana} , t _{PRan} , τ _{Fana} and t _{PFan} for outputs of pin 14 (R OUT), pin 13 (G OUT) and pin 12 (B OUT). (3) Find maximum values of t _{PRan} and t _{PFan} respectively (Δt _{PRan} , Δt _{PFan}).
T ₆₁	Analog RGB Switching Rise-Up Transfer Time	↑	↑	↑	↑	↑	↑	—	—	—	—	—	—	—	—	
T ₆₂	Analog RGB Switching Rise-Up Transfer Time, 3 Axes Difference	↑	↑	↑	↑	↑	↑	—	—	—	—	—	—	—	—	
T ₆₃	Analog RGB Switching Breaking Time	↑	↑	↑	↑	↑	↑	—	—	—	—	—	—	—	—	
T ₆₄	Analog RGB Switching Breaking Transfer Time	↑	↑	↑	↑	↑	↑	—	—	—	—	—	—	—	—	
T ₆₅	Analog RGB Switching Breaking Transfer Time, 3 Axes Difference	↑	↑	↑	↑	↑	↑	—	—	—	—	—	—	—	—	

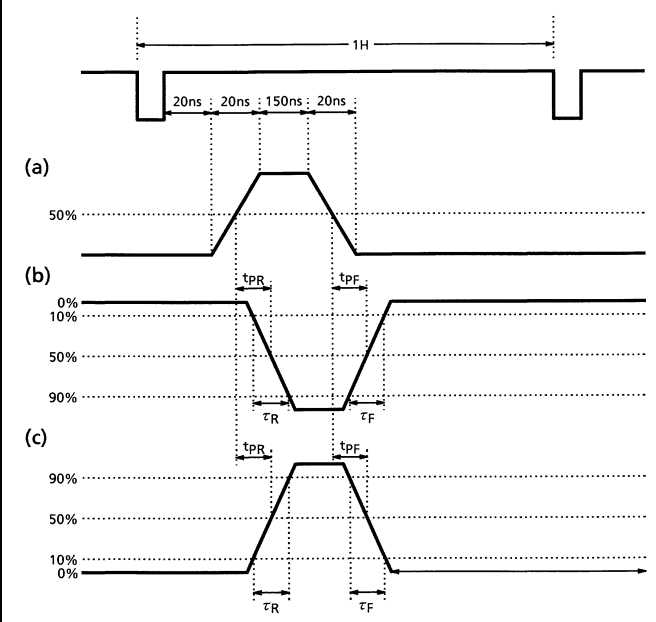

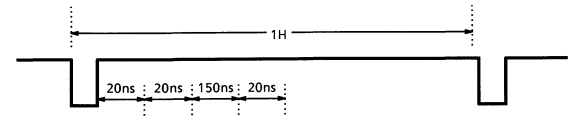
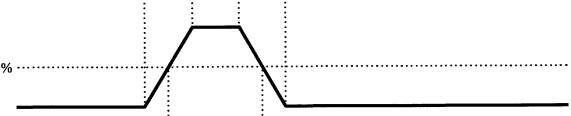
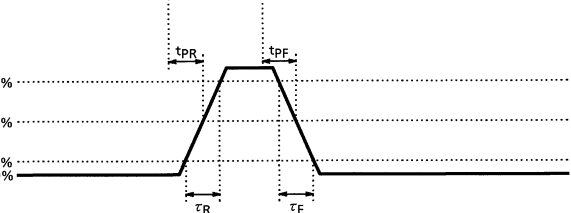
NOTE	ITEM	TEST CONDITION (Unless otherwise specified : H, RGB V _{CC} = 9V ; V _{DD} , Fsc V _{DD} , Y / C V _{CC} = 5V ; Ta = 25±3°C ; BUS = preset value)														
		SW MODE						SUB-ADDRESS & BUS DATA								MEASURING METHOD
		S ₂₁	S ₂₂	S ₃₁	S ₃₃	S ₃₄	S ₅₁	—	—	—	—	—	—	—	—	
T ₆₆	Analog RGB Hi Switching Rise-Up Time	B	A	B	B	B	A	—	—	—	—	—	—	—	—	(1) Supply 2V to pin 22 (Analog Ys). (2) Input 0.5V _{p-p} signal shown by (a) in the following figure to pin 23 (Analog R IN). (3) Referring to (b) of the following figure, measure τ _{RanH} , t _{PRah} , τ _{FanH} and t _{PFah} for output of pin 14 (R OUT).
T ₆₇	Analog RGB Hi Switching Rise-Up Transfer Time	↑	↑	↑	↑	↑	↑	—	—	—	—	—	—	—	—	(4) Input 0.5V _{p-p} signal shown by (a) in the following figure to pin 24 (Analog G IN). (5) Referring to (b) of the following figure, perform the same measurement as the above step 3 for output of pin 13 (G OUT).
T ₆₈	Analog RGB Hi Switching Rise-Up Transfer Time, 3 Axes Difference	↑	↑	↑	↑	↑	↑	—	—	—	—	—	—	—	—	(6) Input 0.5V _{p-p} signal shown by (a) in the following figure to pin 25 (Analog B IN). (7) Referring to (b) of the following figure, perform the same measurement as the above step 3 for output of pin 12 (B OUT). (8) Find maximum axes difference in t _{PRoh} and t _{PFoh} among the three outputs (Δt _{PRah} , Δt _{PFah}).
T ₆₉	Analog RGB Hi Switching Breaking Time	↑	↑	↑	↑	↑	↑	—	—	—	—	—	—	—	—	
T ₇₀	Analog RGB Hi Switching Breaking Transfer Time	↑	↑	↑	↑	↑	↑	—	—	—	—	—	—	—	—	
T ₇₁	Analog RGB Hi Switching Breaking Transfer Time, 3 Axes Difference	↑	↑	↑	↑	↑	↑	—	—	—	—	—	—	—	—	

NOTE	ITEM	TEST CONDITION (Unless otherwise specified : H, RGB V _{CC} = 9V ; V _{DD} , Fsc V _{DD} , Y / C V _{CC} = 5V ; Ta = 25±3°C ; BUS = preset value)														
		SW MODE							SUB-ADDRESS & BUS DATA							MEASURING METHOD
		S ₂₁	S ₂₂	S ₃₁	S ₃₃	S ₃₄	S ₅₁	—	—	—	—	—	—	—	—	
T ₇₂	TV-Analog RGB Crosstalk	B	A	B	B	B	A	—	—	—	—	—	—	—	—	(1) Input TG7 sine wave signal (f = 4MHz, video amplitude = 0.5V) to pin 31 (Y ₂ IN). (2) Short circuit pin 25 (Analog G IN) in AC coupling. (3) Input 0.3V synchronizing signal to pin 51 (Sync IN). (4) Set bus data so that contrast is maximum, Y sub contrast and drive are set at center value. (5) Supply pin 22 (Analog Ys) with 0V of external power supply. (6) Measure video voltage of output signal of pin 13 (G OUT) (Vtg). (7) Supply pin 22 (Analog Ys) with 2V of external power supply. (8) Measure video voltage of output signal of pin 13 (G OUT) (Vana). (9) From measurement results of the above steps 5 and 7, calculate crosstalk from TV to analog RGB. $Crtva = 20\log (Vana / Vtv)$
T ₇₃	Analog RGB-TV Crosstalk	↑	↑	↑	↑	↑	↑	—	—	—	—	—	—	—	—	(1) Short circuit pin 31 (Y ₂ IN), pin 34 (R-Y IN) and pin33 (B-Y IN) in AC coupling. (2) Input 0.3V synchronizing signal to pin 51 (Sync IN). (3) Set bus data so that contrast is maximum and drive is set at center value. (4) Input TG7 sine wave signal (f = 4MHz, video amplitude = 0.5V) to pin 24 (Analog G IN). (5) Supply pin 22 (Analog Ys) with 0V of external power supply. (6) Measure video voltage of output signal of pin 13 (G OUT) (Vant). (7) Supply pin 22 (Analog Ys) with 2V of external power supply. (8) Measure video voltage of output signal of pin 13 (G OUT) (Vtan). (9) From measurement results of the above steps 6 and 8, calculate crosstalk from analog RGB to TV. $Crant = 20\log (Vant / Vtan)$

NOTE	ITEM	TEST CONDITION (Unless otherwise specified : H, RGB V _{CC} = 9V ; V _{DD} , Fsc V _{DD} , Y / C V _{CC} = 5V ; Ta = 25±3°C ; BUS = preset value)															
		SW MODE							SUB-ADDRESS & BUS DATA							MEASURING METHOD	
		S ₂₁	S ₂₂	S ₃₁	S ₃₃	S ₃₄	S ₅₁	—	—	—	01H	15H	—	—	—		—
T ₇₄	ABL Point Characteristic	B	B	B	B	B	A	—	—	—	FFH	10H 90H F0H	—	—	—	—	(1) Input TG7 sine wave signal (f = 4MHz, video amplitude = 0.5V) to pin 31 (Y ₂ IN). (2) Short circuit pin 23 (Analog R IN), pin 25 (Analog G IN) and pin 26 (Analog B IN) in AC coupling. (3) Set bus data so that brightness is maximum and ABL gain is at center value, and supply pin 16 with external supply voltage. While turning down voltage supplied to pin 16 gradually from 7V, measure voltage at pin16 when the voltage supplied to pin 12 decreases by 0.3V in three conditions that data on ABL point is set at minimum, center and maximum values respectively. (Vablpl, Vablpc, Vablph)
T ₇₅	ACL Characteristic	↑	↑	↑	↑	↑	↑	—	—	—	—	—	—	—	—	—	(1) Input TG7 sine wave signal (f = 4MHz, video amplitude = 0.5V) to pin 31 (Y ₂ IN). (2) Input 0.3V synchronizing signal to pin 51 (Sync IN). (3) Measure video amplitude at pin 12. (Vacl1) (4) Measure DC voltage at pin 16 (ABCL). (5) Supply pin 16 with a voltage that the voltage measured in the above step 4 minus 2V. (6) Measure video amplitude at pin 12 (Vacl2) and its ratio to the amplitude measured in the above step 3. $Vacl = 20\log (Vacl2 / Vacl1)$
T ₇₆	ABL Gain Characteristic	↑	↑	↑	↑	↑	↑	—	—	—	FFH	00H 10H 1CH	—	—	—	—	(1) Short circuit pin 31 (Y ₂ IN), pin 34 (R-Y IN) and pin 33 (B-Y IN) in AC coupling. (2) Input 0.3V synchronizing signal to pin 51 (Sync IN). (3) Set bus data on brightness at maximum and measure video DC voltage at pin 12 (Vmax). (4) Measure voltage at pin 16 which is being supplied with the voltage measured in the step 5 of the preceding Note 75. (5) Changing setting of bus data on ABL gain at minimum, center and maximum values one after another, measure video DC voltage at pin 12. (Vabl1, Vabl2, Vabl3) (6) Find respective differences of Vabl1, Vabl2 and Vabl3 from the voltage measured in the above step 3. $Vabl1 = Vmax - Vabl1$ $Vabl2 = Vmax - Vabl2$ $Vabl3 = Vmax - Vabl3$

SECAM SECTION

NOTE	ITEM	TEST CONDITION (Unless otherwise specified : H, RGB V _{CC} = 9V ; V _{DD} , Fsc V _{DD} , Y / C V _{CC} = 5V ; Ta = 25±3°C)																								MEASURING METHOD	
		S	BUS : TEST MODE								BUS : NORMAL CONTROL MODE																
			02H				07H				0FH				10H								1FH				
			26	D ₄	D ₃	D ₂	D ₇	D ₅	D ₄	D ₄	D ₇	D ₅	D ₄	D ₃	D ₂	D ₁	D ₀	D ₇	D ₆	D ₅	D ₄	D ₃	D ₂	D ₁	D ₀		
S ₁	Bell Monitor Output Amplitude	ON	0	1	0	0	0	0	1	0	0	0	0	0	0	0	1	0	0	0	0	0	0	1	(1) Input 200mV _{p-p} (R-Y ID), 75% chroma color bar signal (SECAM system) to pin 42. (2) Measure amplitude of R-Y ID output of pin 36 as ebmo.		
S ₂	Bell Filter f ₀	↑	↑	↑	↑	↑	↑	↑	↑	↑	↑	↑	↑	↑	↑	↑	↑	↑	↑	↑	↑	↑	↑	↑	(1) While supplying 20mV _{p-p} CW sweep signal from network analyzer to pin 42 and monitoring output signal of pin 36 with the network analyzer, measure frequency having maximum gain as foBEL of the bell frequency characteristic. (2) Find difference between foBEL and 4.286MHz as foB-C.		
S ₃	Bell Filter f ₀ Variable Range	↑	↑	↑	↑	↑	↑	↑	↑	↑	↑	↑	↑	↑	↑	↑	↑	↑	↑	↑	↑	↑	Variable	Variable	(1) The same procedure as the steps 1 and 2 of the Note S ₂ . (2) Measure foBEL in different condition that SUB (IF) D ₁ D ₀ = (00) or (11), and find difference of each measurement result from 4.286MHz as foB-L or foB-H.		
S ₄	Bell Filter Q	↑	↑	↑	↑	↑	↑	↑	↑	↑	↑	↑	↑	↑	↑	↑	↑	↑	↑	↑	↑	↑	0	1	(1) The same procedure as the step 1 of the Note S ₂ . (2) While monitoring output signal of pin 36 with network analyzer, measure Q of bell frequency characteristic as QBEL. QBEL = (QMAX -3dB band width) / FoBEL		
S ₅	Color Difference Output Amplitude	OFF	—	—	—	—	—	—	0	↑	↑	↑	↑	↑	↑	↑	↑	↑	↑	↑	↑	↑	↑	↑	(1) Input 200mV _{p-p} (R-Y ID), 75% chroma color bar signal (SECAM system) to pin 42. (2) Measure color difference levels VRS and VBS with signals of pin 35 and pin 36.		
S ₆	Color Difference Relative Amplitude	↑	—	—	—	—	—	—	↑	↑	↑	↑	↑	↑	↑	↑	↑	↑	↑	↑	↑	↑	↑	↑	(3) Calculate relative amplitude from VRS / VBS.		

NOTE	ITEM	TEST CONDITION (Unless otherwise specified : H, RGB V _{CC} = 9V ; V _{DD} , Fsc V _{DD} , Y / C V _{CC} = 5V ; Ta = 25±3°C)																				MEASURING METHOD					
		S	BUS : TEST MODE								BUS : NORMAL CONTROL MODE																
			02H				07H				0FH				10H				1FH								
			D ₄	D ₃	D ₂	D ₇	D ₅	D ₄	D ₄	D ₇	D ₅	D ₄	D ₃	D ₂	D ₁	D ₀	D ₇	D ₆	D ₅	D ₄	D ₃		D ₂	D ₁	D ₀		
S ₇	Color Difference Attenuation Quantity	OFF	—	—	—	—	—	—	0	0	0	0	0	0	0	0	0	1	1	0	0	0	0	0	0	1	(1) The same procedure as the steps 1 and 2 of the Note S ₅ . (2) In the condition that SUB (IF) D ₆ = 1, measure amplitudes of color difference signals of pin 35 and pin36 as VRSA and VBSA respectively, and find SATTR and SATTB from measurement results. $\text{SATTR} = 20\log(\text{VRSA} / \text{VRS}),$ $\text{SATTB} = 20\log(\text{VBSA} / \text{VBS})$
S ₈	Color Difference S / N Ratio	↑	—	—	—	—	—	↑	↑	↑	↑	↑	↑	↑	↑	↑	0	↑	↑	↑	↑	↑	↑	↑	↑	(1) The same procedure as the steps 1 and 2 of the Note S ₅ . (2) Input non-modulated 200V _{p-p} (R-Y) chroma signal to pin 42. (3) Measure noise amplitude nR and nB (mV _{p-p}) appearing in color difference signals of pin 35 and pin 36 respectively. (4) Find S / N ratio by the following equation. $\text{SNB} - \text{S} = 20\log(2\sqrt{2} \times \text{VBS} / \text{nB} \times 10\text{E} - 3)$ $\text{SNR} - \text{S} = 20\log(2\sqrt{2} \times \text{VRS} / \text{nR} \times 10\text{E} - 3)$	
S ₉	Linearity	↑	—	—	—	—	—	↑	↑	↑	↑	↑	↑	↑	↑	↑	↑	↑	↑	↑	↑	↑	↑	↑	↑	(1) The same procedure as the step 1 of the Note S ₅ . (2) Measure and calculate amplitude of black bar levels in output waveforms of pin 35 and pin 36 as shown below. $\text{LinB} = V[\text{cyan}] / V[\text{red}]$ <div style="border: 1px solid black; padding: 5px; display: inline-block; margin: 5px 0;"> Maximum positive / negative amplitudes in respective axes </div> $\text{LinR} = V[\text{yellow}] / V[\text{blue}]$	

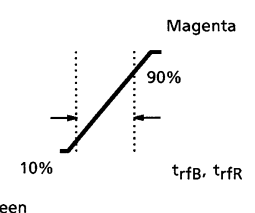
NOTE	ITEM	TEST CONDITION (Unless otherwise specified : H, RGB V _{CC} = 9V ; V _{DD} , Fsc V _{DD} , Y / C V _{CC} = 5V ; Ta = 25±3°C)																				MEASURING METHOD		
		S	BUS : TEST MODE								BUS : NORMAL CONTROL MODE													
			02H				07H				0FH				10H				1FH					
			D ₄	D ₃	D ₂	D ₇	D ₅	D ₄	D ₄	D ₇	D ₅	D ₄	D ₃	D ₂	D ₁	D ₀	D ₇	D ₆	D ₅	D ₄	D ₃		D ₂	D ₁
S ₁₀	Rising-Fall Time (Standard De-Emphasis)	OFF	—	—	—	—	—	0	0	0	0	0	0	0	0	1	0	0	0	0	0	0	1	(1) The same procedure as the step 1 of the Note S ₅ . (2) Measure output waveforms of pin 35 and pin 36 to find the period between the two points shown in the figure in time. 
S ₁₁	Rising-Fall Time (Wide-Band De-Emphasis)	↑	—	—	—	—	—	↑	↑	↑	↑	↑	↑	↑	↑	↑	↑	↑	↑	↑	↑	↑	(3) In the condition that SUB (IF) D ₅ = 1, perform the same measurement as the above step 2. Measurement results are expressed as trfBW and trfRW.	
S ₁₂	Killer Operation Input Level (Standard Setting)	↑	—	—	—	—	—	↑	↑	↑	↑	↑	↑	↑	↑	↑	↑	1	↑	↑	↑	↑	(1) Input 200mV _{p-p} (R-Y ID) standard 75% color bar signal (SECAM system) to pin 42. (2) Attenuate the input signal to pin 42. Measure R-Y ID signal level at pin 42 that turns on / off the killer as eSK and eSC.	
S ₁₃	Killer Operation Input Level (VID ON)	↑	—	—	—	—	—	↑	↑	↑	↑	↑	↑	↑	↑	↑	↑	0	↑	1	↑	↑	(3) In the condition that SUB (IF) D ₃ = 1, perform the same measurement as the above step 2 and express the measurement results as eSK and eSC.	
S ₁₄	Killer Operation Input Level (Low Sensitivity, VID OFF)	↑	—	—	—	—	—	↑	↑	↑	↑	↑	↑	↑	↑	↑	↑	↑	0	1	↑	↑	(4) In the condition that SUB (IF) D ₃ = 0, D ₂ = 1, perform the same measurement as the above step 2 and express the measurement results as eSWK and eSWC.	

TEST CIRCUIT

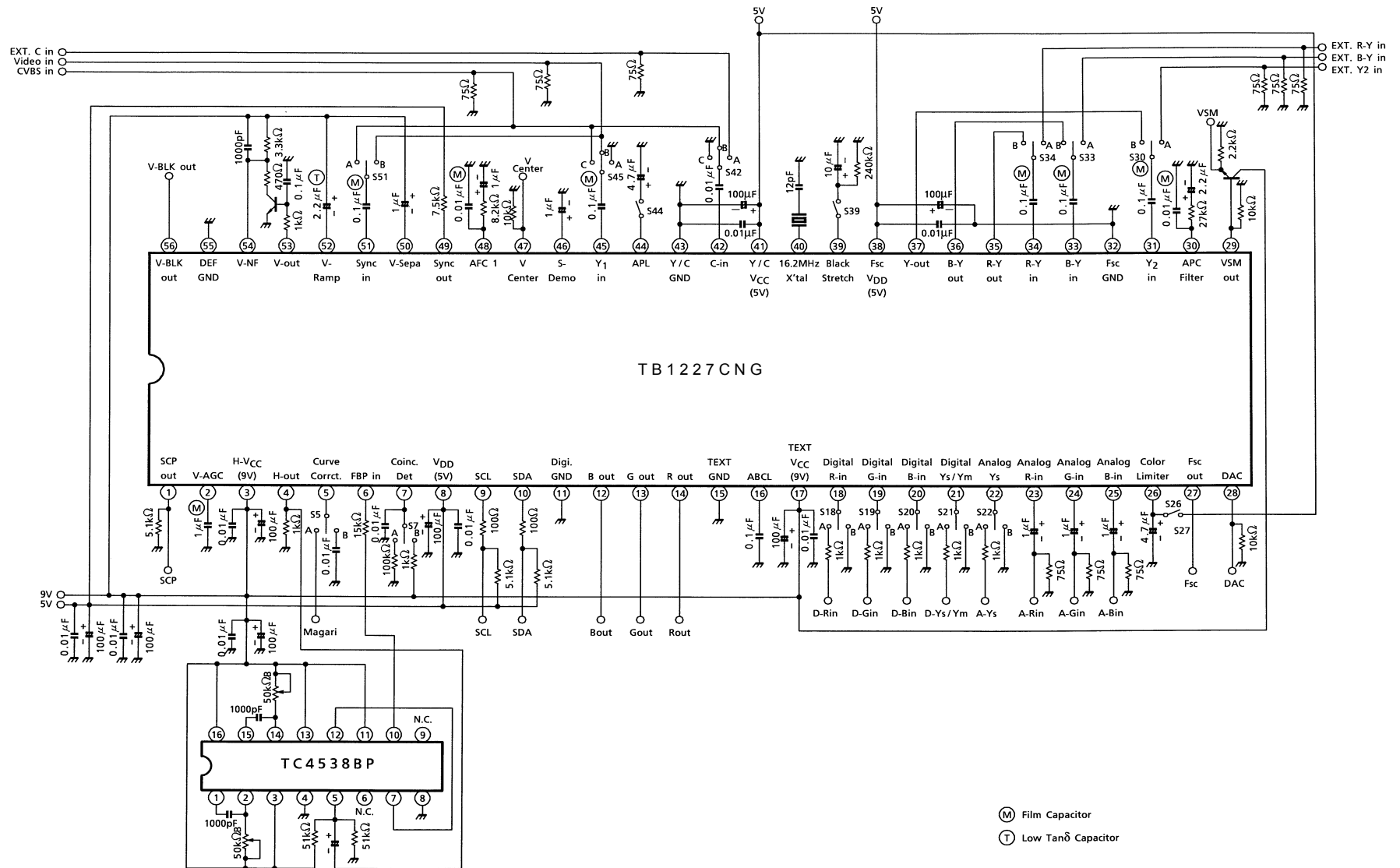

APPLICATION CIRCUIT

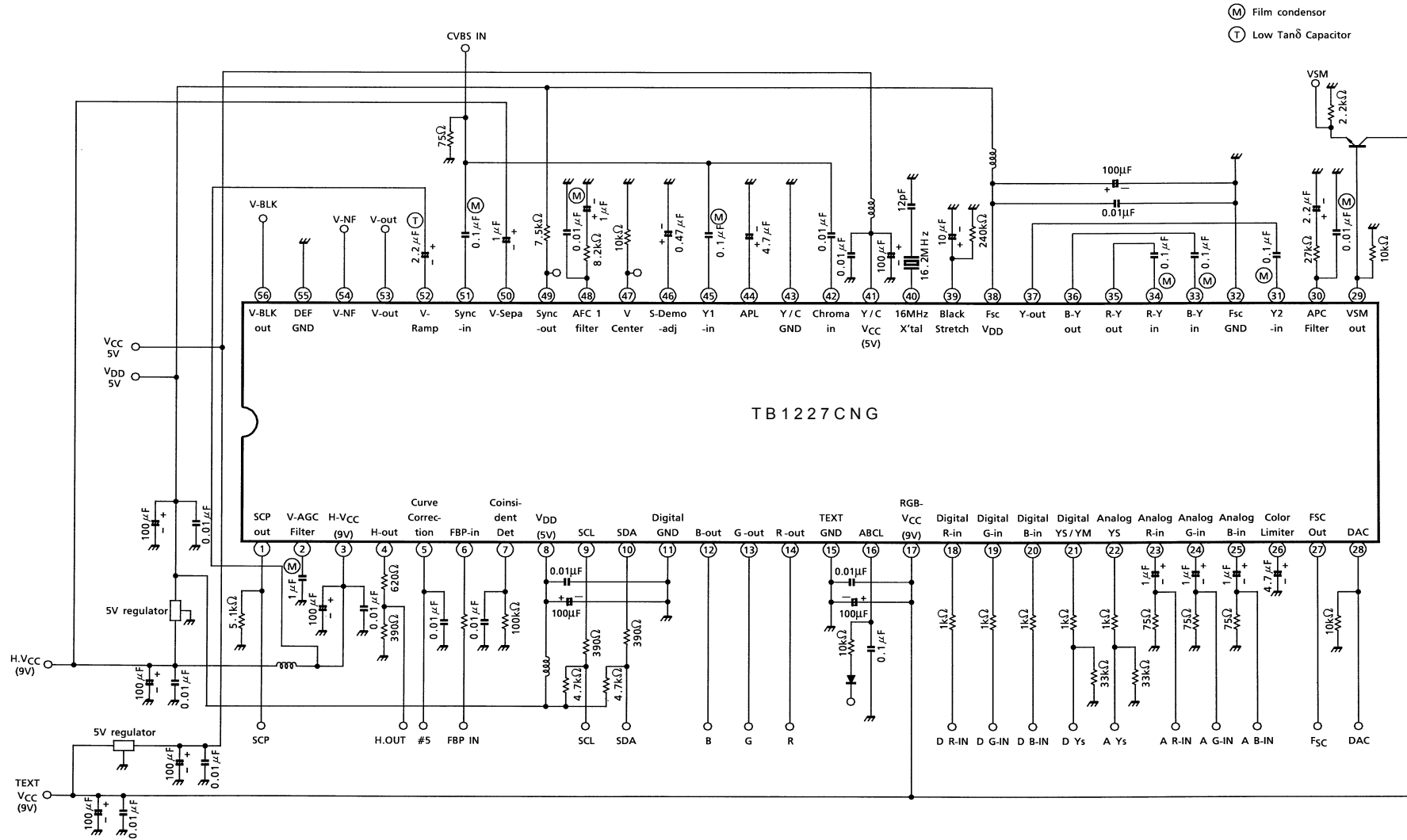

PACKAGE DIMENSIONS

SDIP56-P-600-1.78

Unit : mm

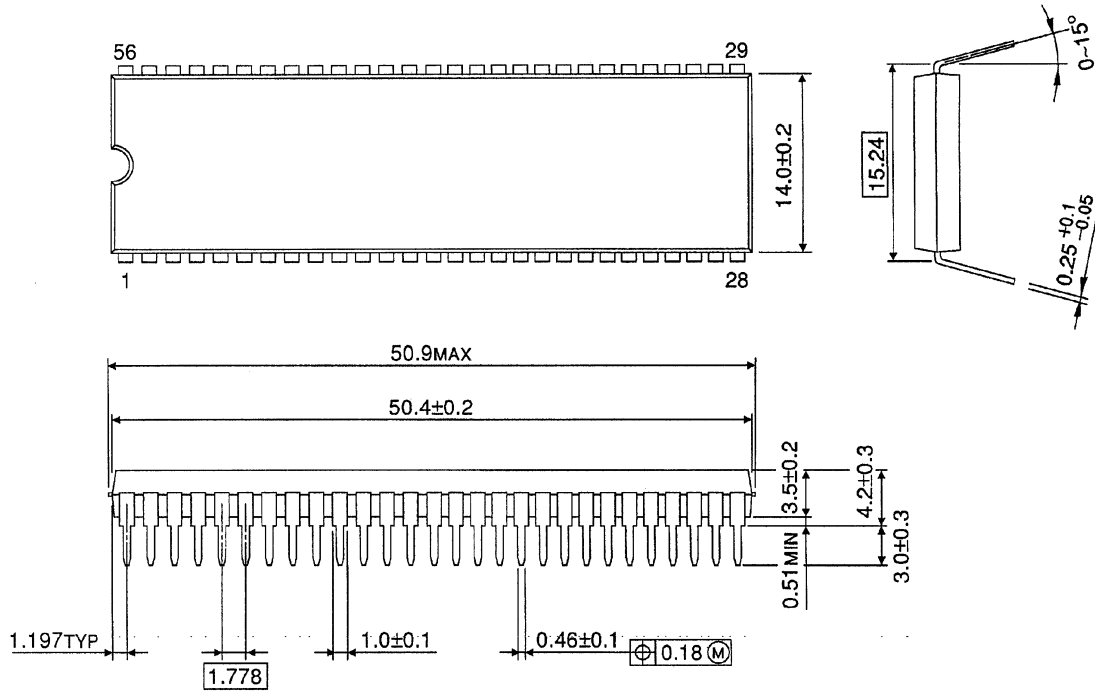

Weight: 5.55g (Typ.)

About solderability, following conditions were confirmed

- Solderability

- (1) Use of Sn-63Pb solder Bath

- solder bath temperature = 230°C
 - dipping time = 5 seconds
 - the number of times = once
 - use of R-type flux

- (2) Use of Sn-3.0Ag-0.5Cu solder Bath

- solder bath temperature = 245°C
 - dipping time = 5 seconds
 - the number of times = once
 - use of R-type flux

RESTRICTIONS ON PRODUCT USE

030619EBA

- The information contained herein is subject to change without notice.
- The information contained herein is presented only as a guide for the applications of our products. No responsibility is assumed by TOSHIBA for any infringements of patents or other rights of the third parties which may result from its use. No license is granted by implication or otherwise under any patent or patent rights of TOSHIBA or others.
- TOSHIBA is continually working to improve the quality and reliability of its products. Nevertheless, semiconductor devices in general can malfunction or fail due to their inherent electrical sensitivity and vulnerability to physical stress. It is the responsibility of the buyer, when utilizing TOSHIBA products, to comply with the standards of safety in making a safe design for the entire system, and to avoid situations in which a malfunction or failure of such TOSHIBA products could cause loss of human life, bodily injury or damage to property.
In developing your designs, please ensure that TOSHIBA products are used within specified operating ranges as set forth in the most recent TOSHIBA products specifications. Also, please keep in mind the precautions and conditions set forth in the "Handling Guide for Semiconductor Devices," or "TOSHIBA Semiconductor Reliability Handbook" etc..
- The TOSHIBA products listed in this document are intended for usage in general electronics applications (computer, personal equipment, office equipment, measuring equipment, industrial robotics, domestic appliances, etc.). These TOSHIBA products are neither intended nor warranted for usage in equipment that requires extraordinarily high quality and/or reliability or a malfunction or failure of which may cause loss of human life or bodily injury ("Unintended Usage"). Unintended Usage include atomic energy control instruments, airplane or spaceship instruments, transportation instruments, traffic signal instruments, combustion control instruments, medical instruments, all types of safety devices, etc.. Unintended Usage of TOSHIBA products listed in this document shall be made at the customer's own risk.
- The products described in this document are subject to the foreign exchange and foreign trade laws.
- TOSHIBA products should not be embedded to the downstream products which are prohibited to be produced and sold, under any law and regulations.