

TB153 **FR**

TB180 **FR**

Hydraulic Excavator

Serial No.

- TB153FR: 15820004~
- TB180FR: 17830004~

Book No. AL5E001

OPERATOR'S MANUAL



WARNING

Read and understand these instructions.
Failure to do so can cause injury or death.

TAKEUCHI





SAFETY ALERT SYMBOL

This symbol means Attention! Be Alert! Your Safety Is Involved. The message that follows the symbol contains important information about safety.

Read and understand the message to avoid personal injury or death.

- **It is the owner or employer's responsibility to fully instruct each operator in the proper and safe operation of all equipment. All persons using this machine should thoroughly familiarize themselves with the following sections.**
- **All operators must be instructed on the proper functions of the excavator before running the machine.**
- **Learn and practice correct use of the machine controls in a safe, clear area before operating this machine on a job site.**

 CAUTION	
 <small>E3A010</small>	<p>Improper operation, inspection and maintenance of this machine can cause injury or death.</p> <p>Read and understand this manual before performing any operation, inspection or maintenance on this machine.</p>

- **Always store this manual near at hand preferably on the machine itself. If it should be lost or damaged, immediately order a new one from your Takeuchi dealer. When transferring ownership of this machine, be sure to provide this manual to the next owner.**
- **Takeuchi supplies machines complying to the local regulations and standards of the country of export. If your machine has been purchased in another country or from a person or company of another country, it may not have the safety devices or safety standards required for use in your country. Should you have any question about whether your machine complies with the regulations and standards of your country, contact a Takeuchi dealer.**
- **Please note that the contents and diagrams included in this manual may not match your machine exactly.**

It is your responsibility to observe all pertinent laws and regulations and to follow the manufacturer’s instructions on machine operation, inspection and maintenance.

Virtually all accidents occur as the result of a failure to observe basic safety rules and precautions. An accident can often be avoided by recognizing potentially hazardous situations beforehand. Read and understand all of the safety messages which explain how to prevent these accidents from occurring. Do not operate the machine until you are sure that you have gained a proper understanding of its operation, inspection and maintenance.

■ SIGNAL WORDS

Safety messages appearing in this manual and on machine decals are identified by the words “DANGER”, “WARNING” and “CAUTION”. These signal words mean the following:

 DANGER

The word “**DANGER**” indicates an **imminently hazardous situation** which, if not avoided, can result in **serious injury or death**.

 WARNING

The word “**WARNING**” indicates a **potentially hazardous situation** which, if not avoided, could result in **serious injury or death**.

 CAUTION

The word “**CAUTION**” indicates a **potentially hazardous situation** which, if not avoided, may result in **minor or moderate injury**.

IMPORTANT: The word “**IMPORTANT**” is used to alert against operators and maintenance personnel about situations which can result in possible damage to the machine and its components.

It is impossible to foresee every possible circumstance that might involve a potential hazard. The warnings in this manual or on the machine can not cover all possible contingencies. You must exercise all due care and follow normal safety procedures when operating the machine so as to ensure that no damage occurs to the machine, its operators or other persons.

■ EXPLANATION OF GRAPHICAL SYMBOLS

Following is an explanation of symbols used in this manual.

 , X prohibition

 /  Lock

 /  Unlock

INTRODUCTION

Foreword

This manual describes operation, inspection and maintenance of the machine, as well as safety instructions to be heeded during these operations.

If you have any questions about the machine, please contact a Takeuchi sales or service outlet.

■ Manual storage compartment

A compartment for storing this manual is provided at the position shown on the diagram below.

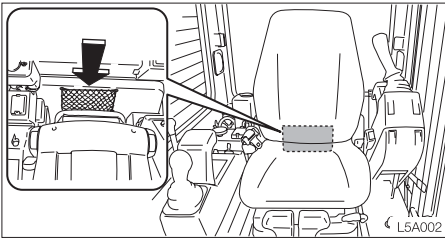

1. After using the manual, place it in the plastic pouch and store it back in the manual storage compartment.

< TB153FR : Canopy >

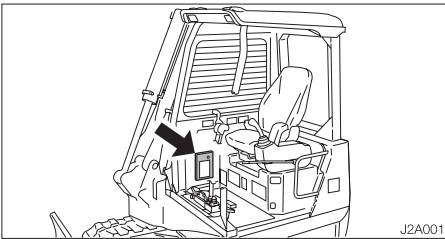

1. Insert the starter key and turn it counterclockwise to unlock the manual storage compartment.

■ Serial numbers

Check the serial numbers of the machine and the engine and write them in the spaces provided below.

Machine number :

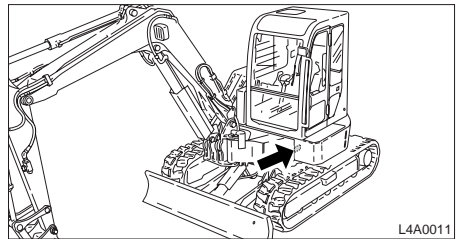

Engine number :

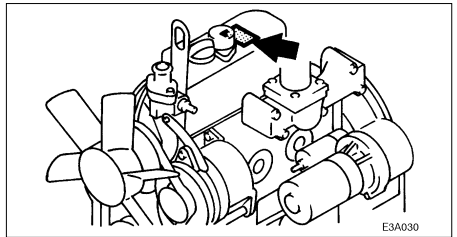

MACHINE DESCRIPTION

■ Front, rear, left and right

This manual refers the front, rear, left and right of the machine as seen when sitting in the operator's seat with the dozer blade visible to the front.

■ Designated operations

Use this machine primarily for the following operations:

- Excavating
- Digging ditches
- Digging side ditches
- Leveling
- Loading

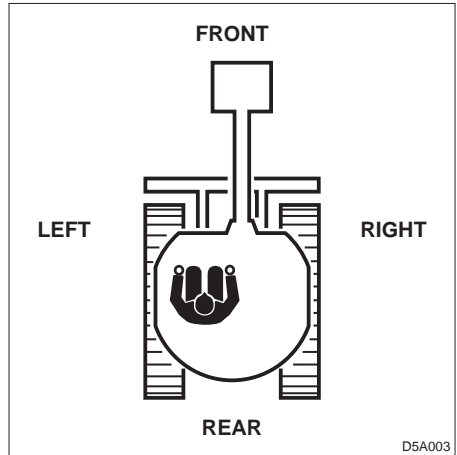

■ Features

- A unique adjustable offset boom system
- Short tail swing radius
- Short pitch rubber crawler
- Low engine noise and exhaust emissions
- Pilot operated joystick controls
- One touch engine deceleration button
- Slew cushioning system for easy bucket positioning
- Engine emergency stop / idle system
- Tilt-up operators platform for easy access to major compartment









■ Break-in period

When the machine is new, heed the instructions below when operating the machine for the first 100 hours (as indicated on the hour meter).

Using a new machine roughly without breaking it in will lead to quicker deterioration of machine performance and may shorten the machine's service life.

- Warm up the engine and hydraulic oil sufficiently.
- Avoid heavy loads and rapid operations. Operate with a load of about 80% the maximum load.
- Do not start up, accelerate, change directions, or stop abruptly unless necessary.

CONTENTS

	Introduction	2
	Machine Description	3
	Safety	7
	Controls	35
	Operation	67
	Transport	101
	Maintenance	107
	Troubleshooting	161
	Specifications	175
	Options	193
	Index	229



SAFETY

General Precautions	8
Preparing Precautions	12
Starting Precautions	14
Operating Precautions	16
Stopping Precautions	23
Transporting Precautions	24
Maintenance Precautions	25
Safety Signs (Decals)	32

**Observe all safety rules**

- Operation, inspection and maintenance of this machine must be performed only by a trained and qualified person.
- All rules, regulations, precautions and safety procedures must be understood and followed when performing operation, inspection and maintenance of this machine.
- Do not perform any operation, inspection and maintenance of this machine when under the adverse influence of alcohol, drugs, medication, fatigue, or insufficient sleep.

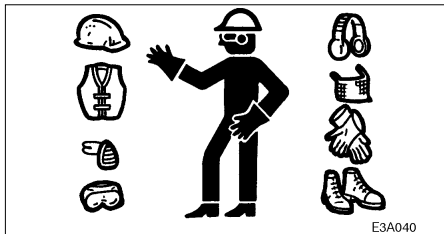
Wear appropriate clothing and personal protective equipment

- Do not wear loose clothing or any accessory that can catch on controls or in moving parts.
- Do not wear oily or fuel stained clothing that can catch fire.
- Wear a hard hat, safety shoes, safety glasses, filter mask, heavy gloves, ear protection and other protective equipment as required by job conditions. Wear required appropriate equipment such as safety glasses and filter mask when using grinders, hammers or compressed air, as metal fragments or other objects can fly and cause serious injury.
- Use hearing protection when operating the machine. Loud prolonged noise can cause hearing impairments, even the total loss of hearing.

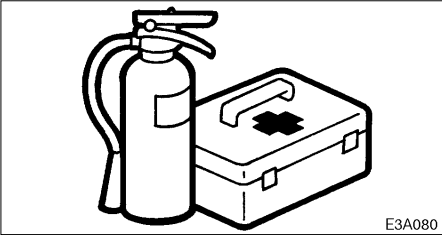
**Provide a fire extinguisher and first aid kit**

- Know where a fire extinguisher and first aid kit are located and understand how to use them.
- Know how to contact emergency assistance and first aid help.

Never remove safety equipment

- Make sure all protective guards, canopies, doors, etc., are in place and secure. Repair or replace damaged components before operating the machine.

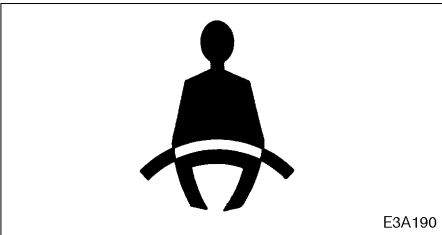

- Know how to use the safety lock lever, seat belt and other safety equipment and use them properly.
- Never remove any safety equipment except for service. Keep all safety equipment in good operating condition.

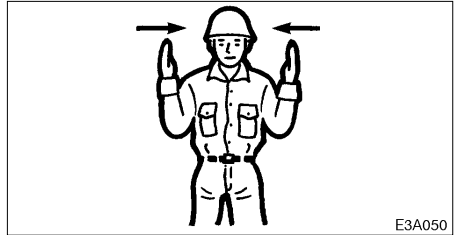
Use a signal person and flagman

Know and use the hand signals required for particular jobs and make sure who has the responsibility for signaling.

- All personnel must fully understand all the signals.
- The operator shall respond to signals only from the appointed signal person, but shall obey a stop signal at any time from anyone.
- The signal person must stand in a clearly visible location when giving signals.



Be sure to lock the safety lock lever before leaving the operator's seat

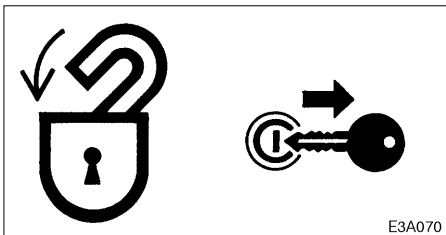

- Before leaving the operator's seat, raise the safety lock lever to engage the lock and stop the engine. If any controls should be touched accidentally when the safety lock lever is lowered, the machine will move suddenly, and cause serious injury or death.
- < TB153FR > : Note that the dozer blade control is not locked, even when the safety lock lever is set to the lock position. Do not touch this control accidentally.
- Before leaving the operator's seat, lower the working equipment, raise the safety lock lever to engage the lock and stop the engine. Also, be sure to remove the key and take it with you.

Avoid fire and explosion hazards



Keep flames away from fuel, hydraulic fluid, oil, grease and antifreeze. Fuel is particularly flammable and dangerous.

- When handling these combustible materials, keep lit cigarettes, matches, lighters and other flames or sources of flames away.
- Do not smoke or permit open flames while fueling or near fueling operations.
- Never remove the fuel cap or refuel with the engine running or hot. Never allow fuel to spill on hot machine components.
- Clean up spilled fuel, oil or other flammable fluids immediately.
- Check for fuel, oil or hydraulic fluid leaks. Stop all leaks and clean the machine before operating.
- Do not cut or weld on pipes or tubes that contain flammable fluids. Clean thoroughly with nonflammable solvent before cutting or welding.
- Remove all trash or debris from the machine. Make sure that oily rags or other flammable material are not stored on the machine.
- Handle all solvents and dry chemicals according to procedures identified on manufacturers' containers. Work in a well-ventilated area.
- Never use fuel for cleaning purposes. Always use a nonflammable solvent.
- Store all flammable fluids and materials in a safe and well-ventilated place.

**Exhaust fumes from the engine can kill**

- Do not operate the engine in an enclosed area without adequate ventilation.
- If natural ventilation is poor, install ventilators, fans, exhaust extension pipes or other artificial venting devices.

Be careful not to get crushed or cut

Never put your hands, feet or other parts of your body between the upperstructure and the undercarriage or tracks, between the machine body and working equipment, or between a cylinder and moving part. The size of these gaps change when the machine moves and if caught a person can suffer severe injury or death.

Handling asbestos dust

Inhaling asbestos dust has been linked to lung cancer. When handling materials which may contain asbestos, take the following precautions:

- Never use compressed air for cleaning.
- Avoid brushing or grinding of the materials.
- For clean up, use wet methods or a vacuum equipped with a high efficiency particulate air (HEPA) filter.
- Wear an approved respirator if there is no other way to control the dust. When working indoors, install a ventilation system with a macro molecular filter.

Using optional products

- Consult with a Takeuchi dealer before installing optional attachments.
- Do not use attachments that have not been approved by Takeuchi or a Takeuchi dealer. Doing so may compromise safety or adversely affect the machine's operation or service life.
- Takeuchi will not be held responsible for any injuries, accidents or damage to its products caused by the use of a non-approved attachment.

Never modify the machine

Unauthorized modifications to this machine can cause injury or death. Never make unauthorized modifications to any part of this machine.



Know the working area

Before starting operation, know the working area to ensure safety.

- Check the topography and ground condition of the working area, or the structure of the building when working indoors, and take the necessary safety measures in dangerous spots.
- Note and avoid all hazards and obstructions such as ditches, underground lines, trees, cliffs, overhead electrical wires or areas where there is danger of a slide.

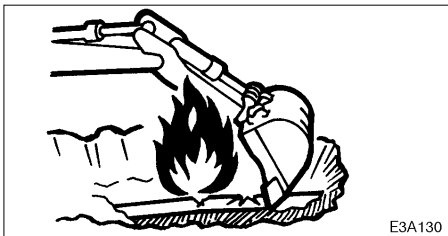

- Check with the local utilities for the locations of buried gas and water pipes and buried power cables. Determine jointly what specific precautions must be taken to insure safety.
- When working on roads, be sure to take into account the safety of pedestrians and vehicles.
 - Use a flagman and / or signals.
 - Fence off the working area and prohibit entry to unauthorized persons.
- When working in water or crossing shallow streams or creeks, check the depth of the water, the solidity of the ground, and the speed of the current beforehand. Make sure the water is not deeper than the allowable depth.

Refer to the section titled "Cautions on Operating" for further instructions.

Always keep the machine clean

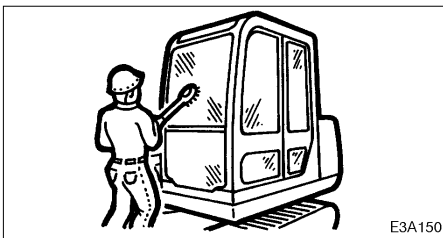

- Clean windows, mirrors and lights to ensure good visibility.
- Wipe off any oil, grease, mud, snow or ice, to prevent accidents due to slipping.
- Remove all loose objects stored in the machine and all objects which do not belong in or on the machine and its equipment.
- Remove any dirt, oil or grease from the engine area, to prevent fires.
- Clean the area around the operator's seat, removing any potential obstacles.

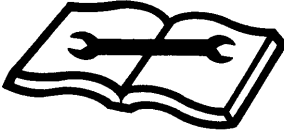
**Perform inspection and maintenance daily**

E3A520

Failure to notice or repair machine irregularities or damage can lead to accidents.

- Before operating, perform the prescribed inspections and make repairs immediately should any irregularities be found.
- If a failure that causes loss of control such as steering, service brakes or engine occurs, stop the machine motion as quickly as possible, follow the shutdown procedure, and keep machine securely parked until the malfunction is corrected.



Maintain three point contact when mounting and dismounting

- Do not jump on or off the machine. Never attempt to mount or dismount a moving machine.
- When mounting and dismounting the cab, first open the door fully to the locked position and check that it does not move. (For machines with cabs)



- Always face the access system and maintain a three point contact with the recommended handrails and steps while getting on and off the machine. Keep steps and platform clean.
- Never use the safety lock lever or control levers as hand holds.

Clear the area of other persons before starting the machine

Do not start the engine until you are sure it is safe. Before starting, check or perform the following.

- Walk around the machine and warn all personnel who may be servicing the machine or are in the machine path. Do not start until all personnel are clearly away from the machine.
- Check for any “DO NOT OPERATE” tags or similar warning notices on the cab door, controls or starter switch.
- Sound horn to alert everyone around the machine.

Start the engine from the operator’s seat

- Adjust, secure and latch the operator’s seat.

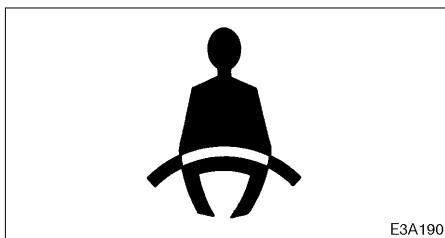

- Fasten the seat belt.
- Check that the parking device is applied and place all controls in the neutral position.
- Check that the safety lock lever is in the lock position.
- Clear the area of all persons.
- Start and operate the engine from the operator’s seat only.
- Never attempt to start the engine by shorting across the starter terminals.

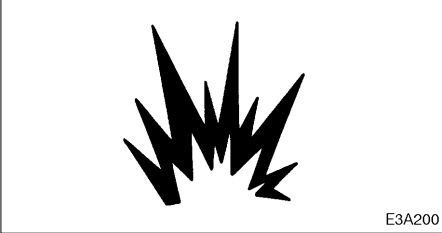
**Starting with jumper cables**

Use jumper cables only in the recommended manner. Improper use of jumper cables can result in battery explosion or unexpected machine motion.

Refer to the section titled “If the Battery Goes Dead” for proper instructions.

After starting the engine

After starting the engine, perform the following operations and checks in a safe place with no persons or obstacles in the area. If any malfunctions are found, follow the shutdown procedure and report the malfunction.

- Warm up the engine and hydraulic fluid.
- Observe all gauges or warning instruments for proper operation.
- Listen for unusual noises.
- Test engine speed control.
- Operate each control to insure proper operation.

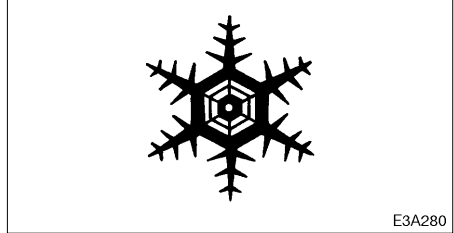
In cold weather

- Be careful of slippery conditions on freezing ground, steps and hand holds.
- In severe cold weather, do not touch any metal parts of the machine with exposed flesh, as flesh can freeze to the metal and Cause injury.
- Do not use ether or starting fluids on this engine. These starting aids can cause explosion and serious injury or death.
- Warm up the engine and hydraulic fluid before operating.

**Ensure good visibility**

- When working in dark places, turn on the machine's working lights and headlights and/or provide extra stationary lighting if necessary.
- When visibility is poor due to severe weather (fog, snow or rain), stop operating the machine and wait until conditions improves.

Do not permit riders on the machine

- Do not allow anyone to ride on any part of the machine at any time while traveling.
- Do not allow anyone to be on any part of the machine while operating.

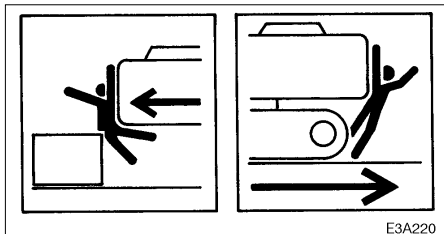
Check for safety in the surrounding area before starting

- Understand the machine limitations.
- Use a signal person where clearances are close or your vision is obstructed.
- Never allow anyone to enter the slewing (swing) radius and machine path.
- Signal your intention to move by sounding the horn.
- There are blind spots to the rear of the machine.

If necessary, swing the cab around before backing up to check that the area is safe and clear.



Check the position of the undercarriage (tracks) before traveling

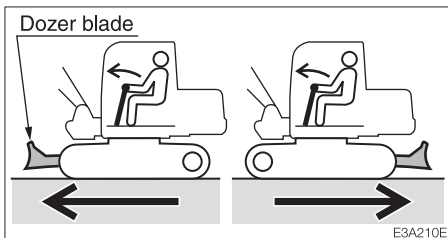

Before operating the travel levers, check to make sure that the dozer blade is to the front of the operator's seat. **BE AWARE** that when the dozer blade is to the rear of the operator's seat, the travel levers operate in the opposite direction to when the dozer blade is in the front.

Travel safety

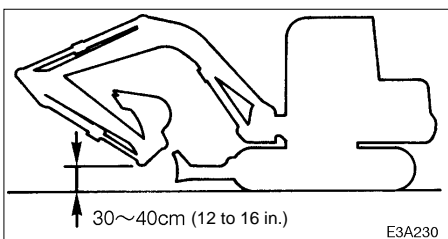

- Travel with the dozer blade up, the hoe attachment folded as shown on the diagram, and the bucket raised 30 to 40 cm (12 to 16 in.) from the ground.
- Do not slew (swing) while traveling. If you must operate the hoe attachment while traveling, operate at speeds slow enough so you have complete control at all times.

- When a load greater than a set value is applied during 2nd speed (high speed) travel, the speed will automatically slow down by switching to 1st speed (low speed). Thereafter, when the load becomes lighter, the speed will increase by returning to 2nd speed (high speed). Exercise due caution since the travel speed changes automatically.

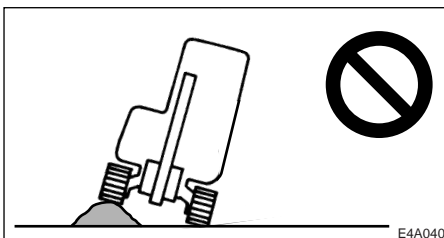

- Avoid crossing over obstacles whenever possible. If you must do so, keep the hoe attachment close to the ground and travel slowly. Never cross obstacles if they will seriously tilt the machine (to an angle of 10° or greater).
- On uneven ground, travel at low speed and avoid accelerating, stopping or changing directions abruptly.
- When roading a machine, know and use the signaling devices required on the machine. Provide an escort for road travel when required.



SAFETY

Operating Precautions

Cautions on traveling on slopes

When traveling on slopes or grades, be careful that the machine does not tip (roll) over or slide.

- Never exceed the machine's stability capabilities (maximum gradeability - 30°, lateral tipping angle - 15°). Also note that when actual working area conditions are poor the machine's stability capabilities may be lower.

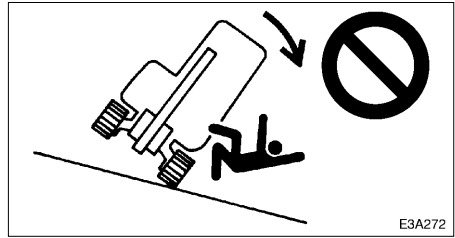

E3A272

- Do not change directions or cross slopes sideways. First return to a flat surface then redirect the machine.

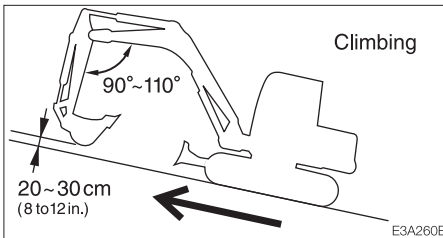
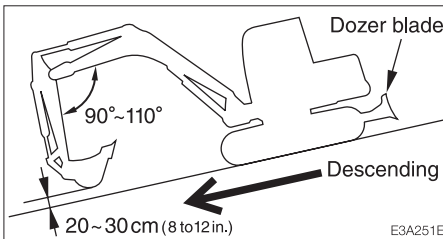

- When traveling on slopes or grades, lower the bucket to a height of 20 to 30 cm (8 to 12 in.) off the ground. In emergencies, lower the bucket to the ground and stop the machine.
- When traveling on slopes or grades, move slowly in first gear (low speed).
- Do not travel down slopes in reverse.
- On grass, dead leaves, wet metal or frozen surfaces, the machine may slide sideways even on very gentle slopes. Make sure the machine never faces sideways with respect to the slope.

Operate on snow or ice with extra care

- When traveling on snow or frozen surfaces, keep the machine travel speed down and avoid accelerating, stopping or changing directions abruptly.
- Remember that the road shoulder, fences, etc., may be buried in the snow and not visible.
- Lower the dozer blade when parked on unsure ground conditions.



Insure driver safety before loading trucks

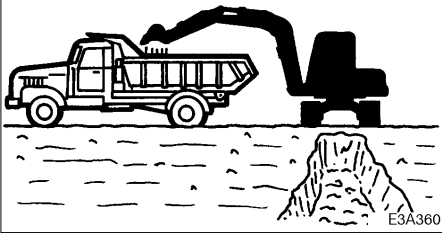

Do not load a truck unless the driver is in a safe place.

- Never swing or position the bucket over personnel or truck cabs.
- Load the truck from the rear.

Keep a safe distance from electrical power lines

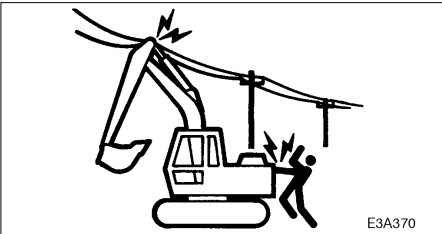

Never approach power lines with any part of the machine and its load unless all local and national required safety precautions have been taken. Electrocutation and death can result from arcing, touching or even being close to a machine that is in contact with or near an electrical source.

- Maintain the maximum possible distance from power lines and never violate the minimum clearance.

- Always contact the nearest electric utility and determine jointly what specific precautions must be taken to insure safety.
- Consider all lines to be power lines and treat all power lines as energized even though it is known or believed that the power is shut off and the line is visibly grounded.
- Use a signal person to observe the approach of any part of the machine or load to the power line.
- Caution all ground personnel to stand clear of the machine and the load at all times.
- If the machine should come in contact with a live electrical source, do not leave the operator's seat. Do not allow anyone to approach or touch the machine.

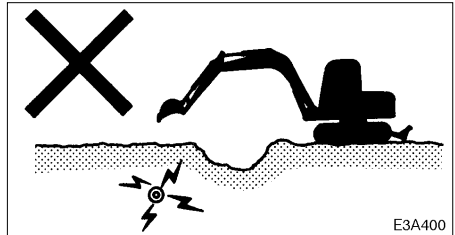

- Be especially careful of buried high voltage power lines.



Watch out for hazardous working conditions

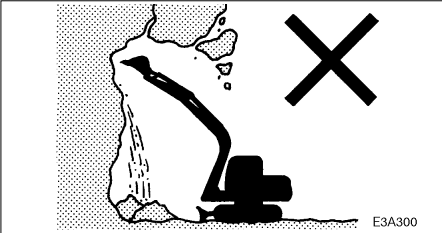

- Never undercut a high bank. Be particularly alert for the possibility of a cave-in.
- Do not operate in places where there is a danger of falling rocks.

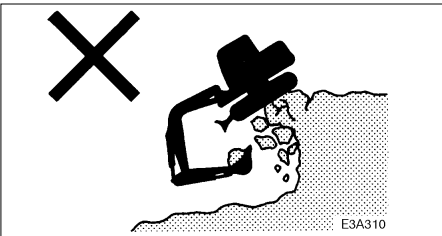

- Keep machine well back from the edge of an excavation. Avoid undercutting the machine.

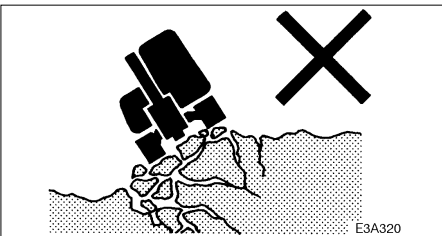

- Do not approach unstable surfaces (cliffs, road shoulders, deep trenches, etc.). The ground may give way under the machine's weight or vibrations, causing the machine to tip over.

- The ground is weak after rain or explosions.
- The ground is also unstable on banks and near dugout trenches.

Operating on slopes is dangerous

When operating on slopes or grades, slewing (swinging) or operating working equipment may cause the machine to lose stability and tip over. Avoid operating on slopes whenever possible.

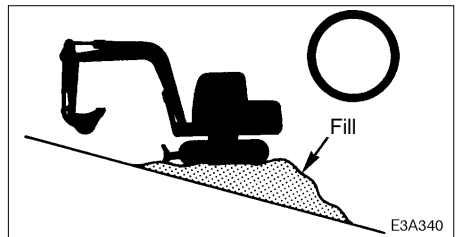

- Level off the work area.

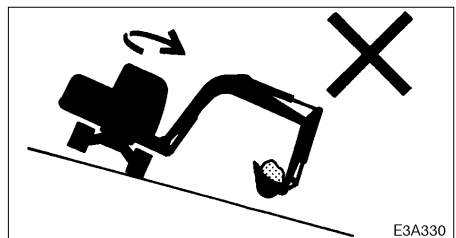

- Avoid swinging the loaded bucket in a downhill direction. This will reduce the stability of the machine.

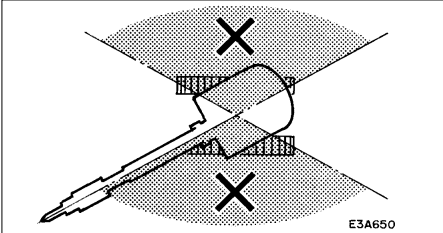
**Never slew (swing) sideways with excessive weights**

The machine can tip over more easily in the lateral direction than in the longitudinal direction.

- Do not slew (swing) sideways with excessive weight at the front. In particular do not slew sideways on slopes.
- The front is heavier for machines equipped with breakers, crushers or telescopic arms than for machines equipped with the standard bucket. Do not operate such machines sideways especially with the digging arm (boom) downhill.

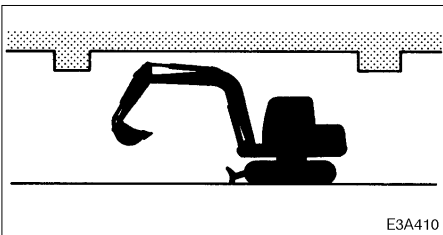
Watch boom clearance

When operating under bridges, in tunnels, near power lines or indoors, be careful not to hit the boom or arm against overhead objects.

Excavators are not designed for lifting loads

The machine is specifically designed for excavation work and has no safety devices for crane operation. Extreme caution should be used if the excavator is used for lifting.

- Never lift loads in excess of capacity. Overload will cause the machine to roll and can result in serious injury or death.
- All rated lift capacities are based on the machine being level and on a firm supporting surface. For safe working loads, the user is expected to make due allowance for the particular job conditions such as soft or uneven ground, non-level condition, side loads, dynamic or jerked loads, hazardous conditions, experience of personnel, etc. The operator and other personnel should fully acquaint themselves with the operator's manual before operating this machine, and rules for safe operation of equipment shall be adhered to at all times.
- Failure of the bucket linkage or slings could result if chains or slings are incorrectly attached, resulting in serious injury or death.
- Do not attempt to pull stumps out of the ground while using the machine as a crane. The loads imposed on the machine under this use are completely unknown.
- Never allow any personnel to stand on or under lifted loads or even within the maneuvering area.



Danger of flying objects

This machine is not equipped with protective guards to protect the operator from flying objects. Do not use the machine in places where there are risks of the operator being hit by flying objects.

Cautions on towing

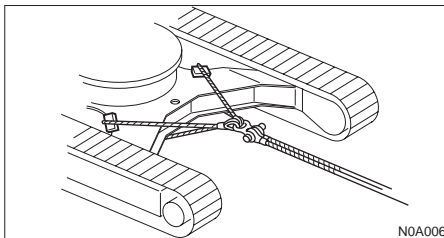

When towing, selecting the wrong wire rope, inspecting improperly, or towing in the wrong way could lead to accidents resulting in serious injury or death.

- The wire rope breaking or coming detached could be extremely dangerous. Use a wire rope suited for the required towing force.
- Do not use a wire rope that is kinked, twisted or otherwise damaged.
- Do not apply strong loads abruptly to the wire rope.
- Use safety gloves when handling the wire rope.
- Make sure there is an operator on the machine being towed as well as on the machine that is towing.
- Never tow on slopes.
- Do not let anyone near the wire rope while towing.

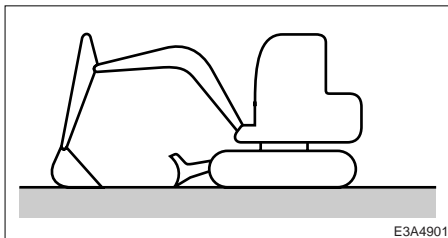
**Park safely**

- Park the machine on firm, level ground and apply the parking device.
- When parking on streets, use barriers, caution signs, lights, etc., so that the machine can easily be seen even at night to avoid collision with other vehicles.

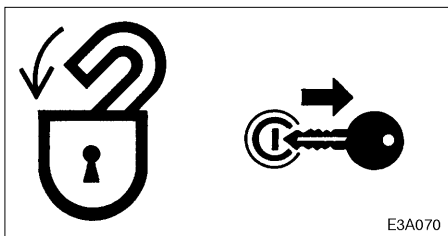

- Before leaving the machine, do the following:
 1. Lower the bucket and dozer blade to the ground.
 2. Raise the safety lock lever to engage the lock.
 3. Stop the engine and remove the key.
 4. Lock the cab and covers.



Load and unload the machine safely

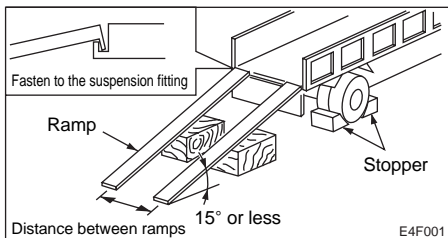

The machine may roll or tip over or fall while loading or unloading it. Take the following precautions:

- Select a firm, level surface and keep sufficient distance from road shoulders.
- Use loading ramps of adequate strength and size. Maintain the slope of loading ramps within 15 degrees.
- Secure the ramps to the truck bed.
- Keep the truck bed and loading ramps clean of oil, clay, ice, snow, and other materials which can become slippery. Clean the tracks.
- Block the transport vehicle so it can not move.
- Use a signal person when loading and unloading the machine, and travel slowly in first gear (low speed).
- Never change course on the ramp.
- Do not slew (swing) on ramps. The machine may tip over.
- When slewing (swinging) on the truck bed, do so slowly as the footing can be unstable.
- Engage the slew (swing) lock after loading.
- Block both tracks and secure the machine to the truck bed with load binders.

Hoist the machine safely

- Know and use correct crane signals.
- Inspect the hoisting equipment daily for damaged or missing parts.
- When hoisting, use a wire rope with sufficient strength with respect to the machine's weight.
- Do not hoist with the machine in a posture other than the one described in the procedure below. Doing so is dangerous as it may result in the machine losing its balance.
Refer to the section titled "Hoisting the Machine" for further instructions.
- Do not hoist the machine with an operator (s) on it.
- When hoisting, hoist slowly so that the machine does not tip.
- Keep all other persons out of the area when hoisting. Do not move the machine over the heads of the persons.

Transport the machine safely

- Know and follow the safety rules, vehicle code and traffic laws when transporting the machine.
- Consider the length, width, height and weight of the truck with the machine loaded on it when determining the best route.

**Attach a “DO NOT OPERATE” tag**

Severe injury could result if an unauthorized person should start the engine or touch controls during inspection or maintenance.

- Stop the engine and remove the key before performing maintenance.
- Attach a “DO NOT OPERATE” tag to the starter switch or control lever.

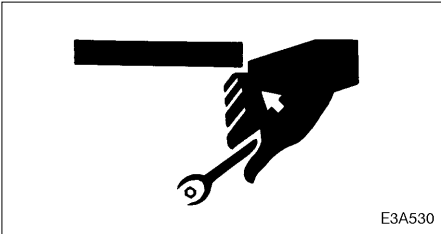
Use the correct tools

Do not use damaged or weakened tools or tools designed for other purposes. Use tools suited for the operation at hand.

Replace important safety parts periodically

- Replace fuel hoses periodically. Fuel hoses become weaker over time, even if they appear to be in good shape.
- Replace important safety parts whenever an irregularity is found, even if it is before the normal time for replacement. Refer to the section titled “Important Parts” for further details.

Anti-explosive lighting

Use anti-explosive electrical fixtures and lights when inspecting fuel, oil, coolant, battery fluid, etc. If lighting that is not anti-explosive should break, the substance could ignite, resulting in serious injury or death.

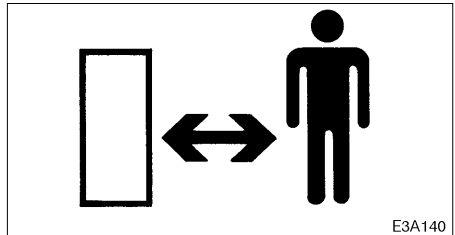
Do not allow unauthorized personnel in the work area

Do not allow unauthorized personnel in the work area. Chips or other debris can fly off machine parts when grinding, welding or using a hammer.



Prepare the work area

- Select a firm, level work area. Make sure there is adequate light and, if indoors, ventilation.
- Clear obstacles and dangerous objects. Eliminate slippery areas.

Stop the engine before performing maintenance

- Avoid lubrication or mechanical adjustments with the machine in motion or with the engine running while stationary.
- If maintenance must be performed with the engine running, always work as a two person team with one person sitting in the operator's seat while the other works on the machine.
 - When performing maintenance, be sure to keep your body and clothing away from moving parts.

Always clean the machine

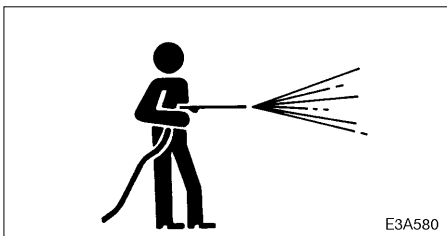

- Clean the machine before performing maintenance.
- Stop the engine and cover electrical parts when washing the machine. Water on electrical parts could cause short-circuits or malfunctions.

Do not use water or steam to wash the battery, sensors, connectors or the operator's seat area.

Stay clear of moving parts

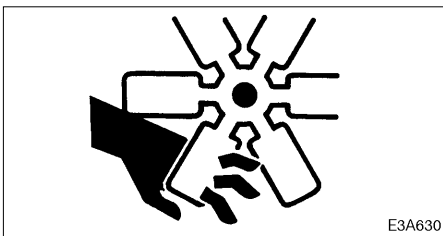

- Stay clear of all rotating and moving parts. Wrapping or entanglement may result in serious injury or death.
- Keep hands, clothing and tools away from the rotating fan and running fan belts.

**Securely block the machine or any component that may fall**

- Before performing maintenance or repairs under the machine, set all working equipment against the ground or in the lowermost position.
- Securely block the tracks.
- If you must work beneath the raised machine or equipment, always use wood blocks, jack-stands or other rigid and stable supports. Never get under the machine or working equipment if they are not sufficiently supported. This procedure is especially important when working on hydraulic cylinders.

Securely block the working equipment

To prevent unexpected movement, securely block the working equipment when repairing or replacing the cutting edges or bucket teeth.

Secure the engine hood or cover when opened

Be sure to secure the engine hood or cover when opening it. Do not open the engine hood or cover on slopes or in strong wind.

Cautions on tilting up the platform

- Raising or lowering the platform while the engine is running may cause the machine to move, and cause serious injury or death. Lower the working equipment to the ground and stop the engine before raising or lowering the platform.
- When the floor is tilted up, support it firmly with the stopper to prevent it from falling.

Place heavy objects in a stable position

When removing or installing the hoe attachment, place it in a stable position so that it does not tip over.

**Use caution when fueling**

- Do not smoke or permit open flames while fueling or near fueling operations.
- Never remove the fuel cap or refuel with the engine running or hot. Never allow fuel to spill on hot machine components.
- Maintain control of the fuel filler nozzle when filling the tank.
- Do not fill the fuel tank to capacity. Allow room for expansion.
- Clean up spilled fuel immediately.
- Tighten the fuel tank cap securely. Should the fuel cap be lost, replace it only with the original manufacturer's approved cap. Use of a non-approved cap without proper venting may result in pressurization of the tank.
- Never use fuel for cleaning purposes.
- Use the correct fuel grade for the operating season.

Handling of hoses

Fuel, oil or hydraulic fluid leaks can cause a fire.

- Do not twist, bend or hit the hoses.
- Never use twisted, bent or cracked hoses, tubes and pipes. They may burst.
- Retighten loose connections.

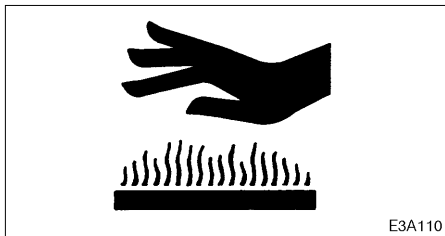
Be careful with hot and pressurized components

Stop the engine and allow the machine to cool down before performing inspection and maintenance.

- The engine, muffler, radiator, hydraulic lines, sliding parts and many other parts of the machine are hot directly after the engine is stopped. Touching these parts will cause burns.
- The engine coolant, oil and hydraulic fluid are also hot and under high pressure. Be careful when loosening caps and plugs. Working on the machine under these conditions could result in burns or injuries due to the hot oil spurting out.

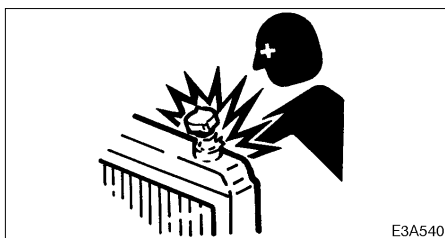
Be careful with hot cooling systems

Do not remove the radiator cap or drain plugs when the coolant is hot. Stop the engine, let the engine and radiator cool and loosen the radiator cap or drain plugs slowly.



Be careful with fluids under pressure

Pressure can be maintained in the hydraulic circuit long after the engine has been shut down.

- Release all pressure before working on the hydraulic system.

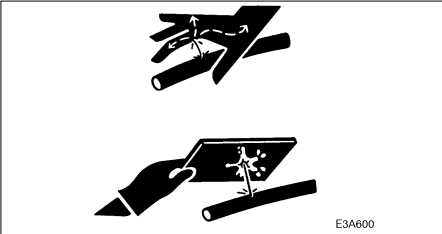

- Hydraulic fluid under pressure can penetrate the skin or eyes and cause injury, blindness or death. Fluid escaping from a small hole can be almost invisible. Wear a safety goggles and heavy gloves and use a piece of cardboard or wood to search for suspected leaks. If fluid is injected into the skin, it must be removed within a few hours by a doctor familiar with this type of injury.

Release all pressure before working on the hydraulic system

Oil may spurt out if caps or filters are removed or pipes disconnected before releasing the pressure in the hydraulic system.

- Gradually press the air breather button to relieve tank pressure.
- Move all the control levers and pedals several times in all directions to release the pressure from the working equipment circuitry. (When equipped with accumulator)
- When removing plugs or screws or disconnecting hoses, stand to the side and loosen slowly to gradually release the internal pressure before removing.

Handling of the accumulator



High pressure nitrogen gas is enclosed in the accumulator and incorrect handling could possibly bring about serious personal injury due to explosion. The following matters should be strictly observed :

- Do not disassemble.
- Do not bring close to fire or throw into a fire.
- Do not make hole, weld, or fuse.
- Do not subject to shock such as hitting or rolling.
- At time of disposal, it will be necessary to release the enclosed gas. Please contact a Takeuchi sales or service outlet.

**Be careful with grease under pressure < TB153FR >**

The track adjuster contains highly pressurized grease. If the tension is adjusted without following the prescribed procedure, the grease discharge valve may fly off, resulting in injury.

- Do not loosen the grease nipple.
- Loosen the grease discharge valve slowly.
- Do not put your face, arms, legs or body in front of the grease discharge valve.
- If no grease is expelled when grease discharge valve is loosened, there is a problem. Contact your nearest service outlet for repairs. DO NOT disassemble, as this is very dangerous.

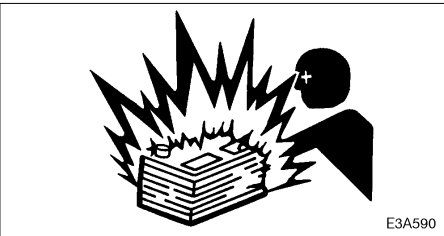
Disconnect the battery

Disconnect the battery before working on the electrical system or doing any welding. Remove the negative (-) battery cable first. When reconnecting the battery, connect the negative (-) battery cable last.

Avoid battery hazards

- Batteries contain sulfuric acid which will damage eyes or skin on contact.
 - If acid contacts eyes, flush immediately with clean water and get prompt medical attention.
 - If acid is accidentally swallowed, drink large quantities of water or milk and call a physician immediately.
 - If acid contacts skin or clothing, wash off immediately with clean water.
- Wear safety glasses and gloves when working with batteries.
- Batteries generate flammable and explosive gases. Keep arcs, sparks, flames and lighted tobacco away.
- Use a flashlight to check battery electrolyte level.
- Stop the engine and shut off electrical equipment while inspecting or handling the battery.
- Do not short circuit the battery posts with metal items.
- Always unfasten the negative (-) battery cable first when disconnecting the battery cable. Always connect the negative (-) battery cable last when fastening the battery cable.
- Loose battery terminals may result in sparks. Be sure to fasten terminals tightly.
- Make sure the vent caps are tightened securely.
- Do not charge a battery or jump-start the engine if the battery is frozen. Warm to 15°C (60°F) or the battery may explode.
- Do not use the battery when the fluid level is below the lower level. Doing so will hasten the deterioration of the internal portions of the battery and shorten the battery life, and can also cause rupturing (or an explosion).
- Do not fill the battery above the upper level. Doing so could cause the fluid to leak, contact and damage the skin, or cause parts to corrode.



SAFETY

Maintenance Precautions

Have a Takeuchi service agent repair welding cracks or other damage

Ask a Takeuchi service agent to repair any welding problems which are detected. If not feasible, make sure the welding is done by a qualified person in a properly equipped workplace.

Vibrations to which the operator is subjected

According to the results of the tests carried out to determine the vibrations transmitted to the operator by the machine, the upper limbs are subjected to vibrations lower than 2.5 m (8.2 ft) / sq.sec. while the seated part of the body is subjected to vibrations lower than 0.5 m (1.64ft) / sq.sec.

Checks after maintenance

- Gradually raise the engine speed from a low idle to maximum speed and check that no oil or water is leaking from serviced parts.
- Move the controls and check that the machine is operating properly.

Disposing of wastes

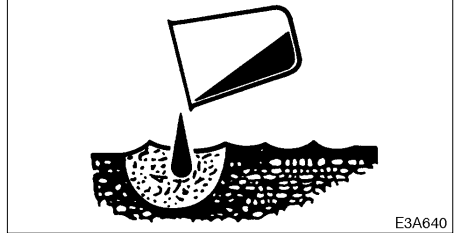

- Funnel spent fluids from the machine into containers. Disposing of fluids improperly destroys the environment.
- Follow the prescribed regulations when disposing of oil, fuel, engine coolant, refrigerant, solvents, filters, batteries or other harmful substances.



The following safety signs (decals) have been placed on your machine in the areas indicated. They are intended for the personal safety of you, and those working with you. Please take this manual, walk around your machine and note the content and location of these safety signs. Review these signs and the operating instructions in this manual with your machine operators.

- Keep the signs legible. If they are not, obtain replacements from your Service outlet.

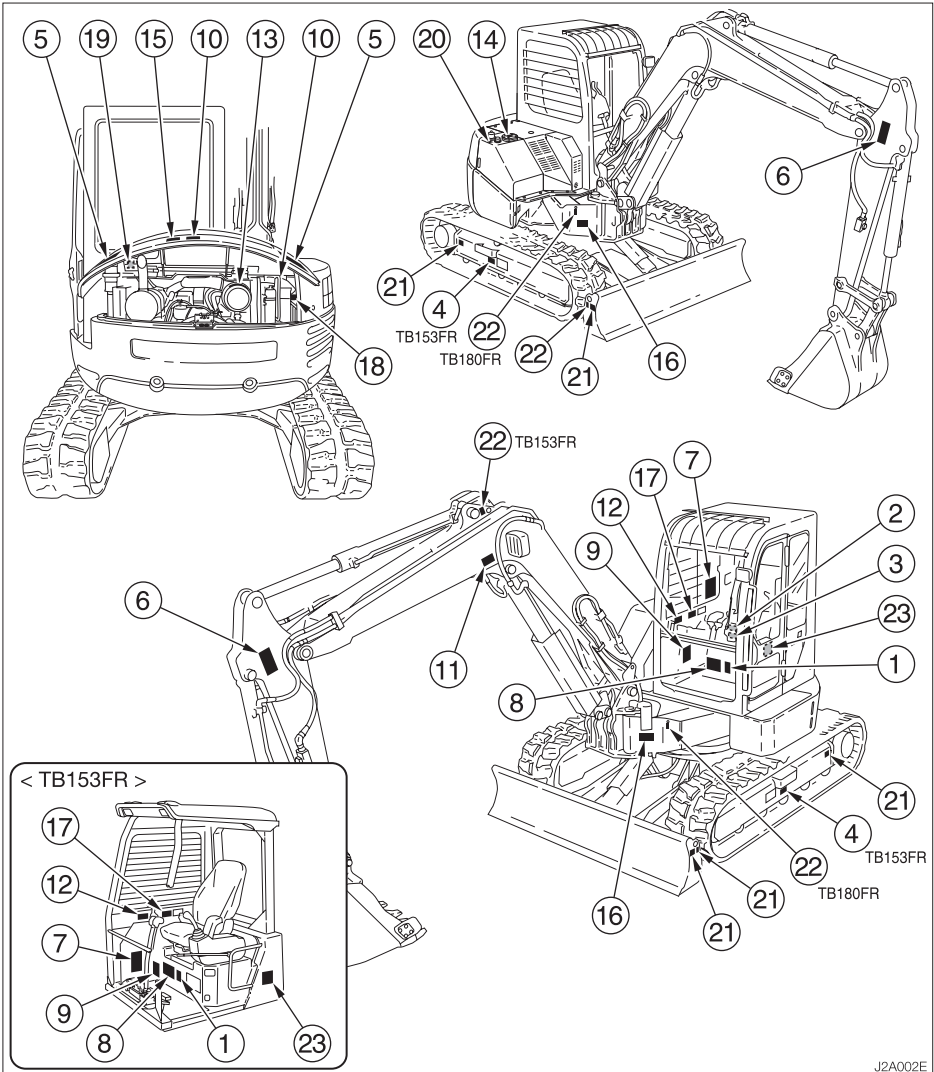



SAFETY

Safety Signs (Decals)

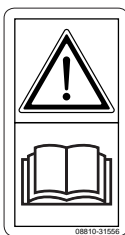

1. No.08810-31556
Warning
Read and understand this manual before performing any operation, inspection or maintenance on this machine.

2. No.08810-31557
Hazard from falling window.
After raising window, be sure to lock it in place with lock pins.

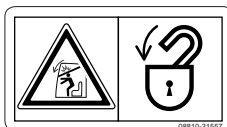

3. No.05793-00045
Hazard at lifting or lowering window
When the front window is opened or closed, it will come close to the head.
Be careful that the window does not strike the head.

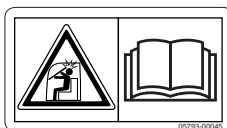

4. No.05793-00052 <TB153FR >
Hazard of a flying plug from track adjuster
Read manual before adjusting track for safe and proper handling.



5. No.05793-00011
Safety Distance
Do not get near or stand within the machine working area.

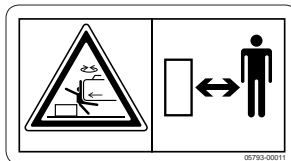

6. No.05793-00049
Safety Distance
Hazard of being hit by the working device of the machine.
Keep away from machine during operation.



7. No.05693-52506

WARNING

Handling the interference prevention system
To ensure operator safety, this excavator is equipped with a system which automatically stops boom or bucket when it approaches the cab to prevent it from hitting the cab.

CAUTIONS ON USE
Do not disassemble or damage the sensors installed on the boom and main body.
In addition, do not install attachments other than those designated by Takeuchi. The interference prevention system may not function properly if other attachments are installed.

Operation when the boom has stopped automatically

- ① If the boom has stopped while rising:
Operate the boom downward.
- ② If the boom has stopped while offsetting to the left:
1. Operate the boom downward to move it outside the automatic stop range.
2. Offset to the left.
* Offsetting to the right is possible regardless of the boom's posture.

Preliminary Inspection
Perform the inspection operation operations described below and check that the bucket, arm and boom do not touch the cab when the boom or bucket is moved near the cab and stops automatically.

- ① Upper part of cab
- ② Offset the boom to the front of the operator's seat and move the boom near the cab.
- ③ Offset the boom to the right and move the bucket near the cab.
- ④ Offset the boom fully to the right and check that it can be set to the maximum rear inclination.
- ⑤ Offset to the left in the posture in ④ above.

05693-52506



SAFETY

Safety Signs (Decals)

8. No.03593-13700

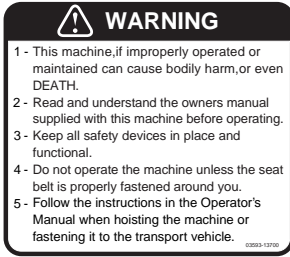

9. No.03793-37300

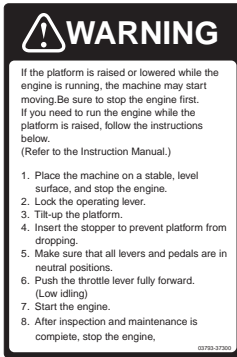

10. No.03593-07400



11. No.03593-47010



12. No.03393-68100



13. No.03393-75040



14. No.03393-75050



15. No.05693-21980

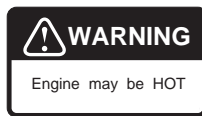

16. No.03993-52302



for USA

17. No.03993-52303



for USA

23. Noise Outside the Cab / for EU
This value indicates the noise level outside the machine and refers to the noise perceived by the persons who are in the vicinity of the work area.

< TB153FR >
No.03393-41031



< TB180FR >
No.05693-49035

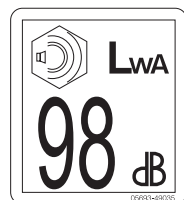

18. No.05693-53810



19. No.03593-06600

Diesel Fuel



20. No.03593-06700

Hydraulic oil



21. No.08810-31549

Tie down point



22. No.03993-00500

Position of Hoisting





CONTROLS

Names of Components	36
Doors and Covers	38
Seat and Seat Belt	44
Instrument Cluster	46
Switches	48
Levers and Pedals	53
Accessories	56

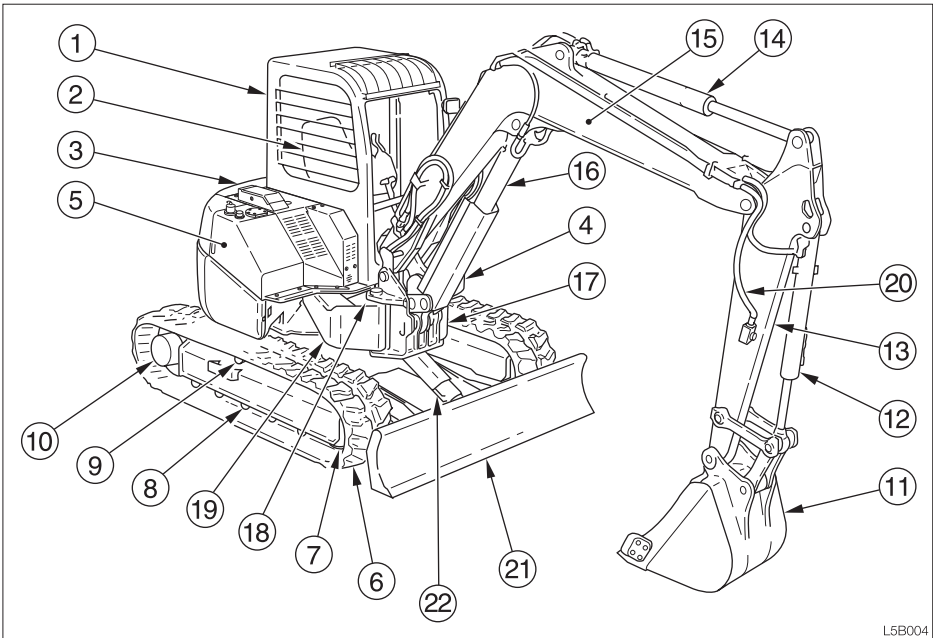

L5B004

Upperstructure

1. Cab
2. Seat
3. Engine hood
4. Fuel tank
5. Hydraulic tank

Undercarriage

6. Crawler belt
7. Idler
8. Track roller
9. Carrier roller
10. Travel motor

Working equipment

11. Bucket
12. Bucket cylinder
13. Arm
14. Arm cylinder
15. Boom
16. Boom cylinder
17. Boom bracket
18. Offset cylinder
19. Right link arm
20. Auxiliary hydraulic lines
21. Dozer blade
22. Blade cylinder

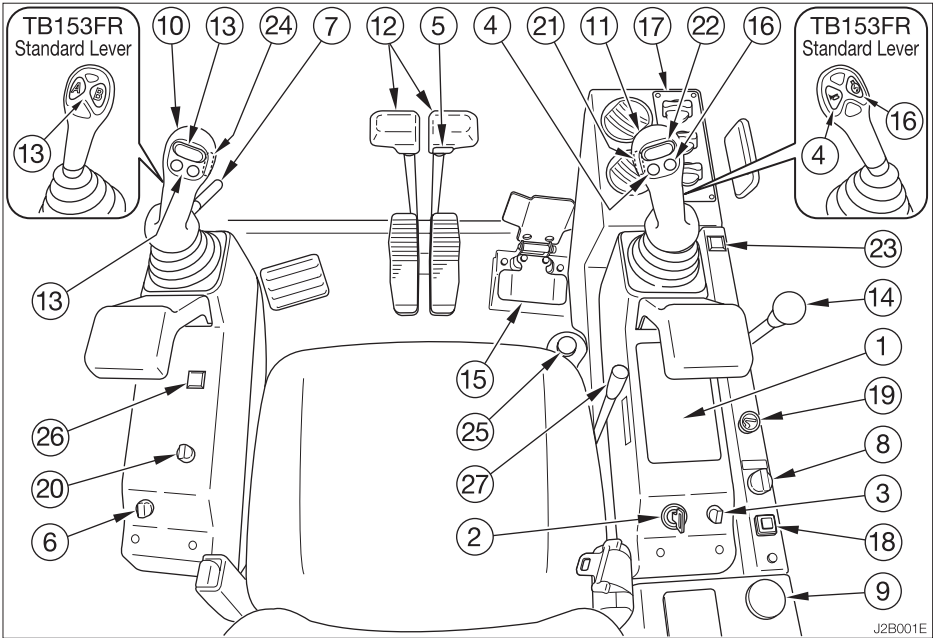

J2B001E

1. Instrument cluster
2. Starter switch
3. Light switch
4. Horn button
5. Travel speed switch
6. Wiper switch (Cab)
7. Safety lock lever
8. Attachment Interference switch
9. Throttle controller < TB180FR >
10. Left operating lever
11. Right operating lever
12. Travel levers
13. First Auxiliary hydraulic switches
14. Blade lever
15. Offset pedal
16. Decel. button
17. Heater & AC control panel
18. Automatic decel. button < TB180FR >
19. Cigarette lighter
20. Overload warning switch (Option)
21. Selector button (2nd or 4th Aux.) (Option) < TB180FR >
22. Second / fourth auxiliary hydraulic switch (Option)
23. Second auxiliary hydraulics operation indicator lamp (Option) < TB180FR >
24. Third auxiliary hydraulic button (Option)
25. Third auxiliary hydraulic switch (Option)
26. Third auxiliary hydraulics warning lamp (Option)
27. Throttle lever < TB153FR >



Starter Key

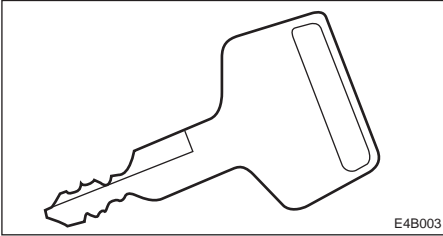

The starter key is used not only to start and stop the engine, but also to lock and unlock the following places :

- Cab door
- Fuel filler cap
- Rear cover
- Rear cover
- Tool box
- Manual storage compartment (Canopy)

Cab Door



When mounting and dismantling the cab, first open the door fully to the locked position and check that it does not move.

Open the door fully and press it against the catch at the back of the door to lock it in place. Always lock the door when mounting and dismantling and when operating the machine.

Lock and unlock

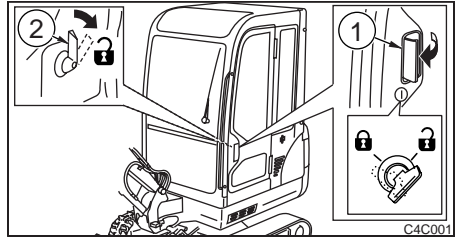

1. Insert and turn the starter key.

Opening

1. Pull the knob (1) towards you and open the door.
To open the door from inside the cab, push the lever (2) to the front.
2. Open the door fully and press it against the cab to lock it in place.

Closing

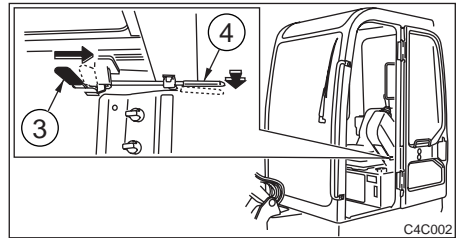

1. Either push release lever (3) to the front or lower release lever (4).
2. Close the released door.



Front Window (Cab)

WARNING

- Grasp the handles firmly with both hands when opening and closing the front window. Your head or hands may get caught if they slip.
- When the front window is opened or closed, it will come close to the head. Be careful that the window does not strike the head.
- If you open the front window, be sure to lock it in place with the knobs (latch) (2) on the left and right sides. The window may fall if it is not locked in place.

Opening

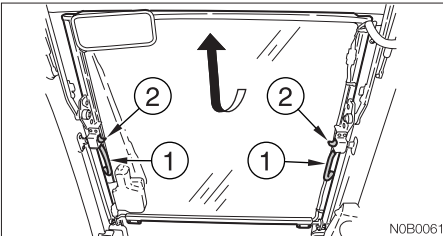

1. Grasp the left and right handles (1) and press the knobs (2) with your thumb to release the lock.
2. Pull the front window toward you and lift while doing so.

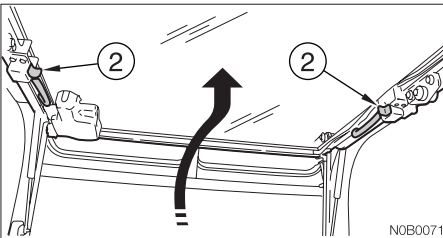

3. Lift the front window fully and then release your thumb from the knobs (2) and lock the front window.

Closing

WARNING

When closing the front window, lower the window slowly so as not to hit your head. Lowering the window abruptly may result in injury or damage the front window.

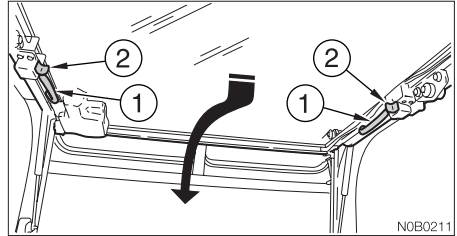

1. Grasp the left and right handles (1) and press the knobs (2) with your thumb to release the lock.
2. Pull down the front window and while doing so, slide it to the front and slowly lower it.

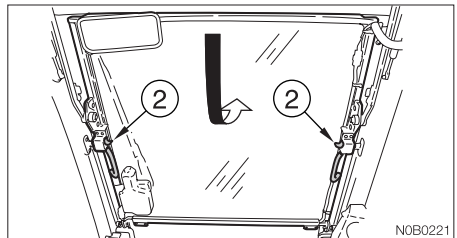

3. Lower the front window fully and then release your thumb from the knobs (2) and lock the front window.



Lower Front Window (Cab)

Removing

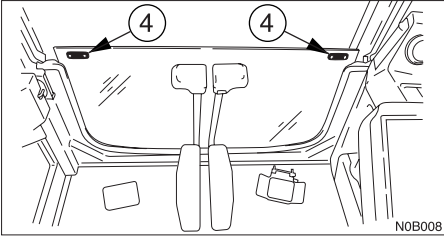

1. Open the front window and stow it in the ceiling.
2. Grasp the protruding parts (4) on the left and right with your fingers and slowly lift the lower front window off.

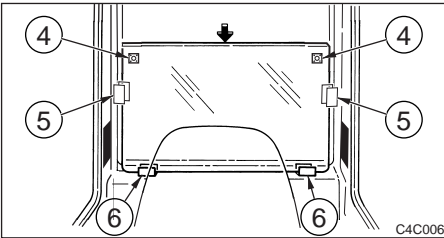

3. Hold the glass firmly, place the lower front window through the guides (5) at the rear, then set it on the supports (6) and fasten it in place.

Side Window (Cab)

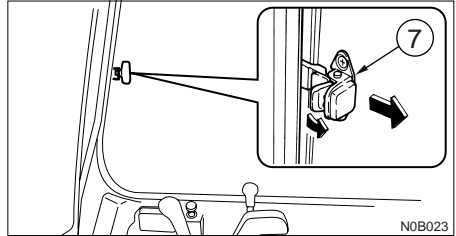

1. Grasp the catch (7), unlock it and open the side window.
2. To close the side window, close it until a click is heard.

Tool Case

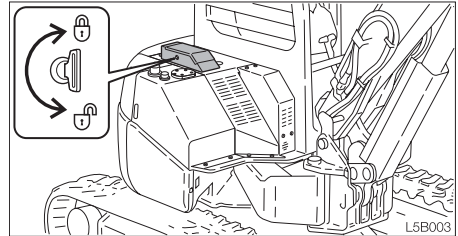

Lock and unlock

1. Insert and turn the starter key counterclockwise (clockwise) to unlock (lock).



Rear Cover

⚠ CAUTION

- When opening the rear cover, open it firmly to the locked position.
- When opening and closing the rear cover, be careful not to get your hands or other parts of your body caught.

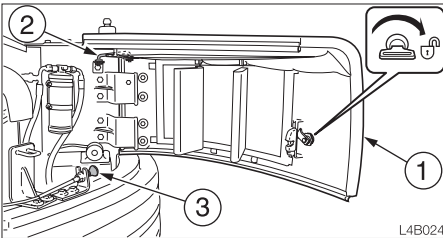

Opening

1. Insert the starter key and turn it clockwise to unlock the rear cover (1).
2. Open the rear cover (1) fully until it stops. (It locks automatically)
3. Check that the rear cover (1) is securely locked in place.

Engine hood unlock knob (3) is located behind the rear cover (1).

Closing

1. Raise the stay (2) to unlock the rear cover (1).
2. Close the rear cover (1) and press it inside until a click is heard at the front.

Engine Hood

⚠ WARNING

Before opening the engine hood, be sure to stop the engine. If your hands or tools should get caught in the fan or fan belt while the engine is running they may be severed.

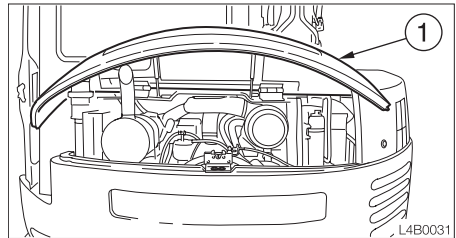

Opening

1. Open the rear cover and pull the unlock knob (3). Refer to "Rear Cover".
2. Lift the engine hood (1) fully.

Closing

1. Close the engine hood and press it down until a click is heard at the front.



Fuel Filler Cap

WARNING

- Do not smoke or permit open flames while fueling or near fueling operations.
- Supply fuel in a well ventilated place and with the engine stopped.
- Clean up spilled fuel immediately.
- Do not fill the fuel tank to capacity. Allow room for expansion.
- Tighten the fuel filler cap securely.

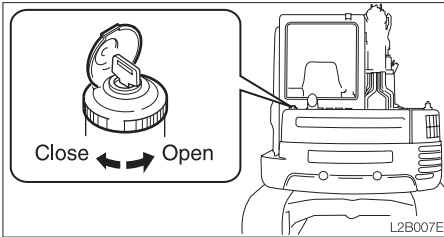

Opening

1. Open the key cover, insert and turn the key counterclockwise to unlock the fuel cap.
2. Turn the fuel cap counterclockwise and remove it.

Closing

1. Set the fuel cap in place and turn it clockwise.
2. Turn the key clockwise to lock the fuel cap, then remove the key.

MEMO



Seat

⚠ WARNING

Adjust, secure and latch the operator's seat.

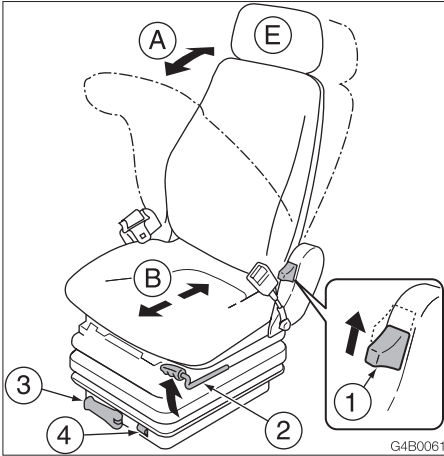

G4B0061

(A) Back angle adjustment**⚠ WARNING**

- Do not set the seat back to its maximum reclining position and slide the seat backwards at the same time. Doing so may break the rear window glass, resulting in injury.
- Be careful not to allow the force of the spring to bring the seat back sharply forward.

1. Raising your torso, sitting down firmly in the seat.
2. Pulling lever (1) allows you to use the pressure of the springs in the seat pressing against your back to adjust the reclining angle of the seat back. Release the lever (1) at the desired angle and the seat back will be locked in that position.

(B) Fore-and-aft adjustment

1. Pull on lever (2) and slide the seat backward or forward to bring it to the optimum position for operating the machine.
 2. Release the lever (2) at the desired position and the seat will be locked there.
- Adjustment stroke: 15 steps, 150 mm (5.9 in.)

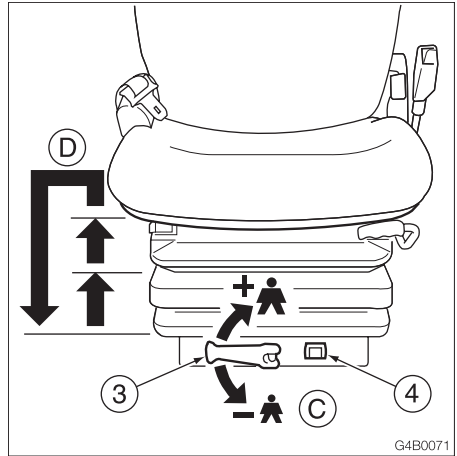

G4B0071

(C) Weight adjustment

1. Turn handle (3) until the indicator (4) will show the operator's weight.
May be set to any value from 10 kg steps, 50 to 130 kg (110 to 287 lbs.)

(D) Adjusting the height of the seat

Upward

1. Lift the seat to first or second position click-stop.

Downward

1. First lift the seat to highest position, then the seat can be lowered to lowest position.

(E) Headrest adjustment (Option)

The position of the headrest can be adjusted in the vertical and front/back directions.

1. To adjust in the vertical direction, grasp the headrest with both hands and move it upwards or downwards.
2. To adjust in the front/back direction, grasp the headrest with hands and move it forwards or backwards.

**Seat Belt** **CAUTION**

Always fasten the seat belt securely before starting the engine.

Fastening the seat belt

1. Adjust the seat to the optimum position for operating, raise your torso, and sit back firmly into the seat.
2. Pull the seat belt to the desired length.

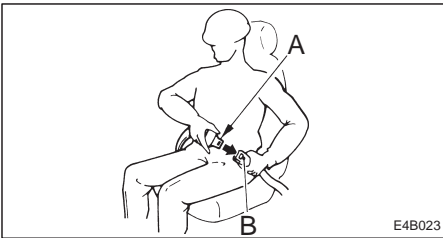

3. Make sure that the belt is not twisted and then insert the tongue plate (A) into the buckle (B) of the seat belt until you hear a clicking sound as it locks in place.

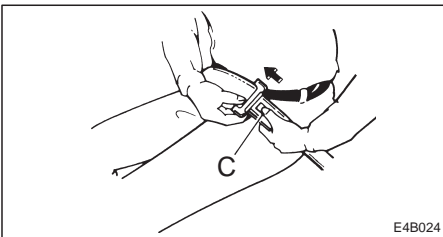
Releasing the seat belt

1. To remove the seat belt, simply press the button (C) located on the buckle. The seat belt is automatically stowed away.

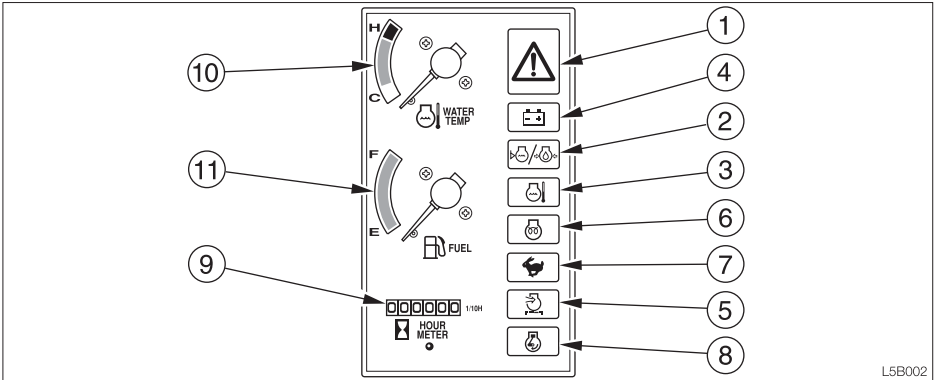

L5B002

Warning Lamps

IMPORTANT: If a warning lamp flashes and an alarm is sounded, stop all operations immediately and inspect and maintain the appropriate part.

Refer to page 169 “Troubleshooting”.

1. Engine Emergency Lamp



This lamp flashes and an alarm is sounded if the engine oil pressure or the coolant level in the radiator

drops or the coolant temperature rises abnormally while the engine is running. After approximately 5 seconds, the engine stops or low idling automatically.

2. Engine Oil Pressure / Coolant Level Warning Lamp



This lamp flashes and an alarm is sounded if the lubricant oil pressure or coolant level in the radiator

drops abnormally while the engine is running.

3. Coolant Temperature Warning Lamp



This lamp flashes and an alarm is sounded if the engine coolant temperature rises abnormally while the engine is running.

4. Battery Charge Warning Lamp

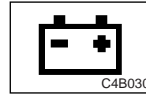

This lamp flashes and an alarm is sounded if a problem arises in the charging system while the engine is running.

5. Air Cleaner Warning Lamp



This lamp flashes and an alarm is sounded if the air cleaner filter is clogged while the engine is running.



Indicators

6. Glow Lamp



This lamp turns off when engine preheating is completed.

7. Travel Speed Lamp



This lamp lights when the travel speed is set to 2nd (high speed).

8. Decel. Lamp



This lamp lights when decel. switch pressed, the engine speed decreases.

Meters

9. Hour Meter



This displays the total engine running time in hours.

The rightmost digit indicates tenths of hours (6 minutes).

Set the inspection and maintenance intervals according to the time displayed on the hour meter.

10. Water Temperature Gauge

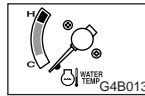

This gauge indicates the temperature of the engine coolant water.

The needle should be within the green range during machine operation. The red range indicates overheating.

11. Fuel Gauge



This gauge indicates the amount of fuel in the tank. Be sure to top off the tank before running out of fuel.



Starter Switch

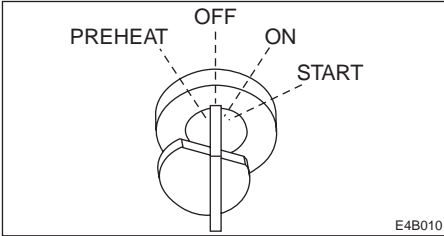

IMPORTANT: Do not repeatedly switch the key from OFF to ON and ON to OFF over a short period. Doing so will cause engine breakdown.

- PREHEAT Position for preheating the engine.
- OFF Position for stopping the engine and inserting or removing the key.
- ON Position in which the engine is running. At this position, all the electrical equipment is functional.
- START Position for starting the engine. When the key is released, the switch automatically returns to the ON position.

Battery Switch

IMPORTANT: Never set this switch to the OFF (O) position while the engine is running. Doing so might cause damage to the electrical system.

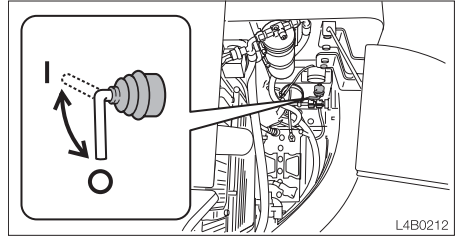

1. Open the rear cover.
- OFF (O) Switches off the electrical circuit. Be sure to set this switch to the OFF (O) position when storing the machine for a long period, or when performing maintenance of the electrical system.
 - ON (I) Connects the electrical system. Check that this switch is in the ON (I) position before starting the engine.

Supplement: Setting this switch to the OFF (O) position will shut down all of the electrical circuits and the memory of the radio preset tuning buttons will be deleted.



Horn Button

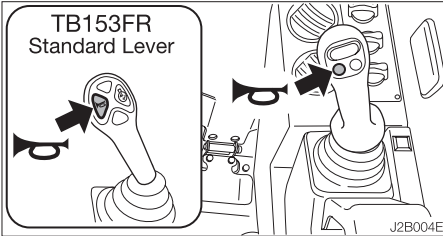

Press the button on the right operating lever to blow the horn.

Decel. Button

**WARNING**

Set the operating and travel levers to neutral before operating the decel. button. The machine's operating speed will change abruptly if the switch is operated while the levers are engaged.

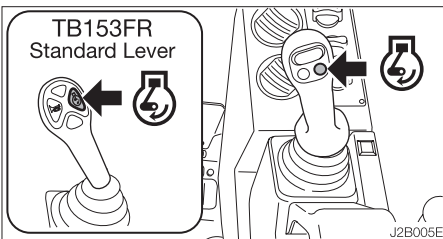

Press the button on the right operating lever to lower the engine speed to low idling. Press the button again to return to the engine speed set with the throttle controller.

Supplement: The one-touch decelerator is a device for lowering the engine speed and reducing fuel consumption when little engine output is required, for example when the operating and travel levers are in neutral.

Automatic Decel. Button < TB180FR >

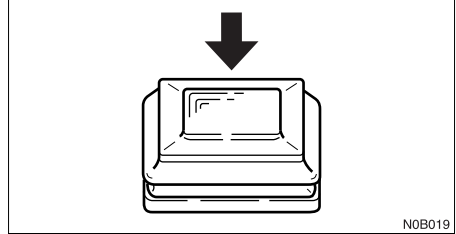

Pressing this button to the ON position will cause the lamp to light and will activate the deceleration function. Use of the deceleration button will not be possible at this time. After about 4 seconds with the control levers set to neutral, the engine speed will automatically drop to Low idling to reduce fuel consumption. Moving the control levers will cause the speed to return to the original engine speed.

Throttle Controller < TB180FR >

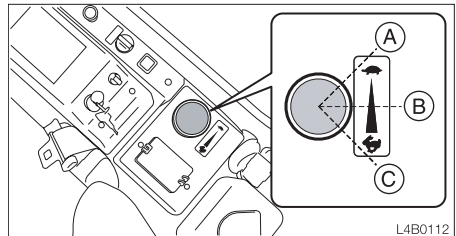

This controls the engine speed.

- (A) Low idling
- (B) Middle speed
- (C) Maximum speed



Attachment Interference Switch

WARNING

- Failure to properly set the Attachment Interference Switch can result in equipment damage, serious injury, or death.
- Ensure that all buckets used in the standard position are no longer than a standard bucket when measured from pin to tooth.

The Attachment Interference Switch (AIS) is automatically set to the M mode by the interference Prevention System (IPS) when the engine is started.

To use the minimal front radius feature, reset the AIS to the M position then select the appropriate attachment width (S.L or M).

< TB153FR >

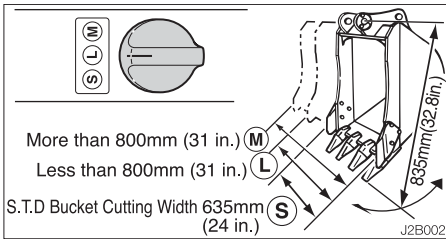

< TB180FR >

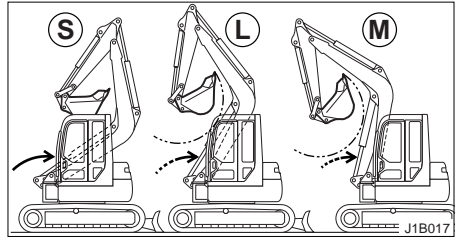
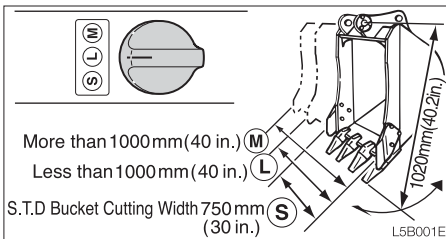

Modes of Operation

< TB153FR >

- S** Standard bucket attachment less than 635mm (24 inches) wide
- L** Bucket attachment more than 635mm (24 inches) and less than 800mm (31 inches) wide
- M** Bucket attachment more than 800mm (31 inches) wide or any other approved attachment

< TB180FR >

- S** Standard bucket attachment less than 750mm (30 inches) wide
- L** Bucket attachment more than 750mm (30 inches) and less than 1000mm (40 inches) wide
- M** Bucket attachment more than 1000mm (40 inches) wide or any other approved attachment

Refer to page 82 "Attachment Interference Switch / Interference Prevention System".



Travel Speed Switch

WARNING

When a load greater than a set value is applied during 2nd speed (high speed) travel, the speed will automatically slow down by switching to 1st speed (low speed). Thereafter, when the load becomes lighter, the speed will increase by returning to 2nd speed (high speed). Exercise due caution since the travel speed changes automatically.

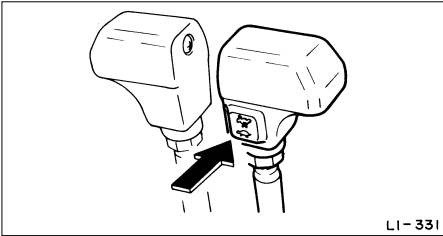

Press this switch to set the travel speed to 2nd speed (high speed). Press again to return to 1st speed (low speed).

First Auxiliary Hydraulic Switches

Slider Switch (Proportional control)

Proportional control allows for slow-to-fast movement of auxiliary functions. Example: If you move the slider switch half way, the auxiliary function will move at approximately one-half speed.

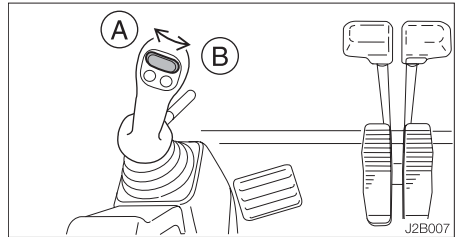

Move this switch to control the flow of the oil in the first auxiliary hydraulic lines.

Auxiliary Hydraulic Buttons

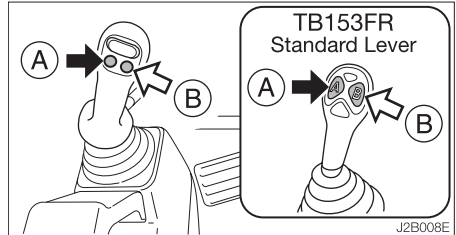

Press those buttons to control the flow of the oil in the first auxiliary hydraulic lines.

- Proportional control of the auxiliary hydraulic circuit is not possible.

- (A) ... Hydraulic oil flows to left auxiliary line(a)
 (B) ... Hydraulic oil flows to right auxiliary line(b)



Light Switch

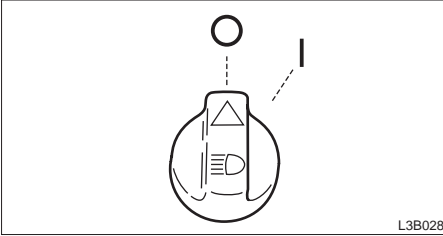

When this switch is turned while the starter switch is at ON, the lights turn on as follows :

O Off

I Meter light, front light and boom light turn on.

Wiper Switch (Cab)

IMPORTANT: If no washer fluid is discharged, do not operate the washer. Doing so may damage the pump.

IMPORTANT: Operating the wiper with no moisture on the windshield will scratch the glass. Apply water or washer fluid when operating the wiper.

IMPORTANT: In cold seasons, the wiper blade may freeze to the glass. Operating the wiper forcibly may damage the wiper motor.

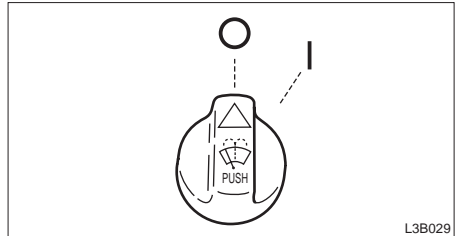

O Off

I Wiper operates.

PUSH Washer fluid is squirted from the nozzle while pressed, and stops when released.



Safety Lock Lever

WARNING

- Before leaving the operator's seat, raise the safety lock lever to engage the lock and stop the engine. If any controls should be touched accidentally when the safety lock lever is lowered, the machine will move suddenly, and cause serious injury or death.
- < TB153FR > : Note that the dozer blade control is not locked, even when the safety lock lever is set to the lock position. Do not touch this control accidentally.
- Be careful not to touch the operating levers when raising and lowering the safety lock lever.

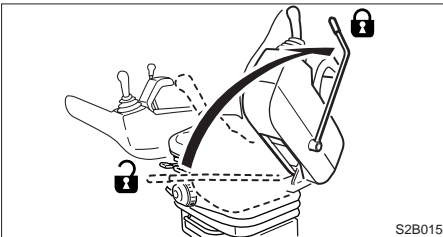

This device is for locking the working equipment, auxiliary hydraulic control, slewing and traveling.

When the lever is raised, the lever stand springs up and the lever is locked.

- < TB153FR > : Note that the dozer blade control is not locked, even when the safety lock lever is set to the lock position. Do not touch this control accidentally.

Operating Levers

WARNING

- Be careful to check which pattern of lever control arrangement you are operating with before beginning operations.
- The explanations in this manual are for the ISO pattern.

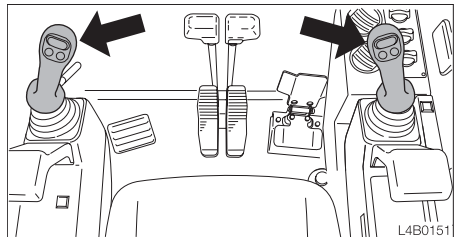

Use these levers to operate the boom, arm, bucket and upperstructure (slew).

Refer to page 74 "Lever Pattern".

Refer to page 84 "Operating the Working Equipment".

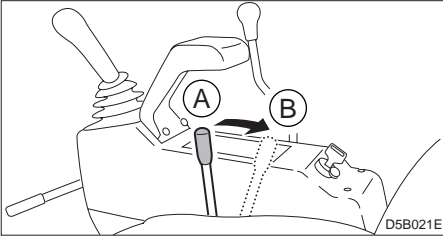
**Throttle Lever < TB153FR >**

This controls the engine speed.

- (A) Low idling
- (B) Maximum speed

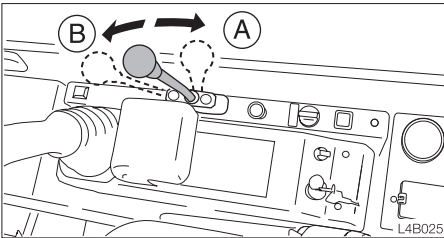
Blade Lever

Use this lever to operate the dozer blade.

- (A) Blade up
- (B) Blade down

Refer to page 85 “Operating the Dozer Blade”.

Travel Levers**⚠ WARNING**

Before operating the travel levers, check to make sure that the dozer blade is to the front of the operator’s seat. **BE AWARE** that when the dozer blade is to the rear of the operator’s seat, the travel levers operate in the opposite direction to when the dozer blade is in the front.

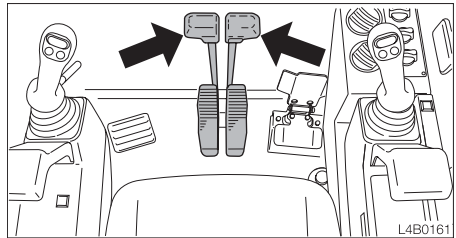

Use these to move forward and backward and to change directions.

Refer to page 79 “Operating the Travel Levers”.



Offset Pedal

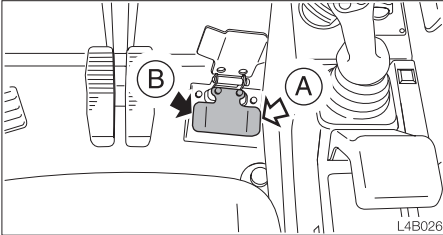

Use this pedal to operate the boom offset.

(A) Boom offset right

(B) Boom offset left

Refer to page 85 “Operating the Boom Offset”.

Pedal Lock



When not using the pedal, set the pedal lock to the locked position. Stepping on a pedal accidentally when it is not locked may lead to unexpected accidents.

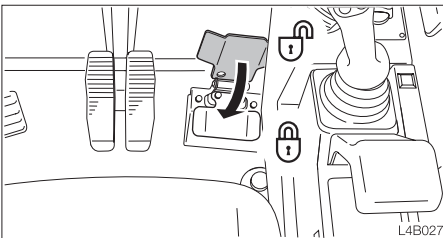

This device is for locking the offset pedal.
Set the pedal lock over the pedal to lock it.



Heater (Cab)

WARNING

- Always be sure to allow sufficient ventilation.
- Do not place combustible or explosive objects near the air outlets.

Control panel

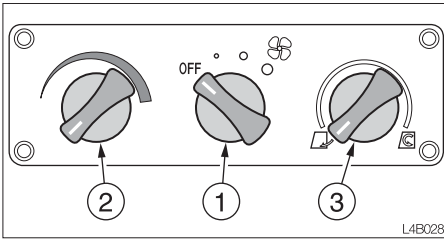

Fan Switch (1)

Use this switch to adjust the fan speed in three steps.

- OFF Fan off
- Low
 - Medium
 - High

Temperature Control Dial (2)

Use this dial to adjust the air temperature.
Counterclockwise

..... To lower the temperature
Clockwise To increase the temperature

Supplement: No warm air is emitted if the temperature of the engine coolant is low.

Airflow mode control dial (3)

Use this dial to select recirculation or fresh air intake.

- Recirculation
 - To cool or heat the cab quickly
 - When external air is dirty
- CENTER 50% fresh air intake
 - To ventilate while heating the cab slowly
- Fresh air intake
 - To remove fog from the windows
 - To ventilate while heating the cab

Outlets

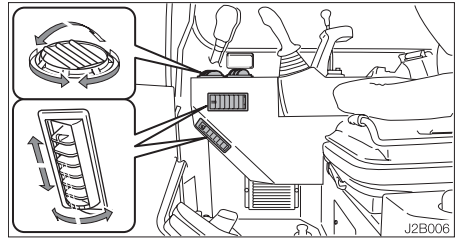

Move the louvers up and down or left and right to adjust the air flow direction and amount.

Supplement: Use the heater with care in warm seasons. Coolant circulates in the heater even when the heater switch is turned off.

When the heater is no longer needed, stop coolant circulation as follows :

IMPORTANT: Use the valve (1) either fully open or fully closed.

Cooling water could leak when the valve is set at a halfway position.



< TB153FR >

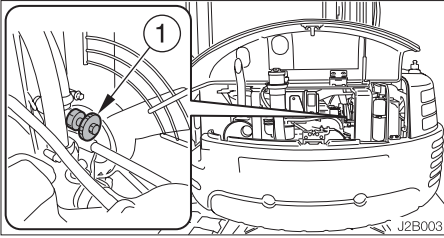

< TB180FR >

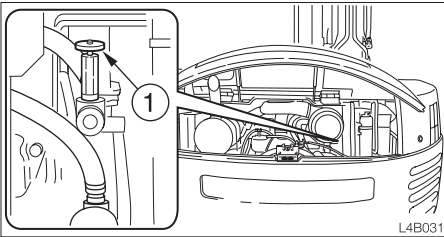

1. Park on a flat surface and stop the engine.
2. Open the engine hood.
3. Turn the valve (1) clockwise until it stops to close it.

Interior Light (Cab)

IMPORTANT: The battery capacity will decrease if the interior light is left on for long periods of time the engine stopped. Turn the lamp off when leaving the machine.

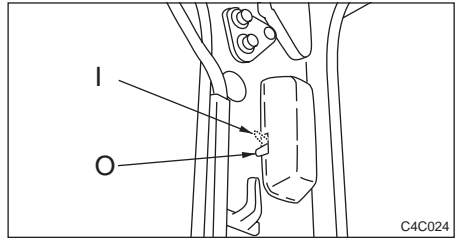

- O Off
I Lit



Cigarette Lighter (Cab)

WARNING

- Do not leave the cigarette lighter's knob pressed in. Doing so heats up the lighter, and could be dangerous.
- If the knob does not pop out after 30 seconds, it may be broken. Pull it out by hand.
- Do not use other cigarette lighters, as they may get stuck.
- Only use applicable electric products with this socket.
- Do not touch metal parts of the lighter. Doing so could cause burns.

This is the cigarette lighter and internal power supply socket.

When using the wiper and this socket simultaneously, be careful not to exceed 12V / 10A.

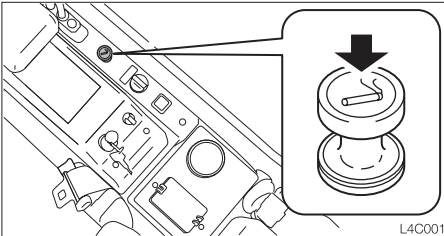

1. Press the lighter in.
2. Release the lighter and wait for it to pop out. The lighter pops out automatically when the heater becomes red.
3. Once the lighter pops out, pull it out.

Ashtray (Cab)

WARNING

- Be sure to extinguish cigarettes and matches completely before putting them in the ashtray, and always close the ashtray afterwards.
- Do not overfill the ashtray with cigarette butts or put in paper or other easily burnable objects. Doing so could lead to fire.

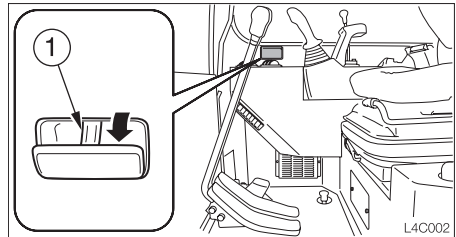

Pull the ashtray out towards you to use it. To clean, press the ash discharge button (1) and pull out the ashtray.



External Power Sockets (for EU)

WARNING

Only use applicable electric products with these sockets.

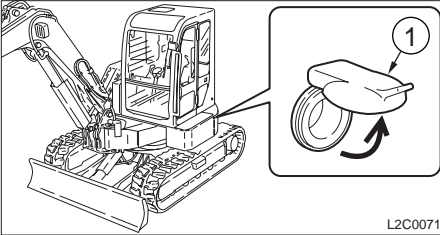

for Beacon

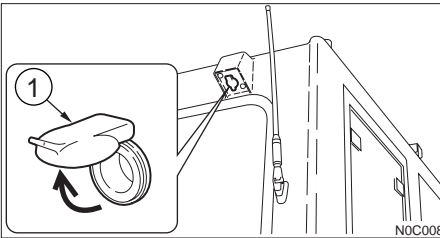

Use these sockets as an external power supply. When using these sockets, be careful not to exceed 12V / 10A.
To use, raise the cap (1).

Applicable plug: BOSCH 0352321007

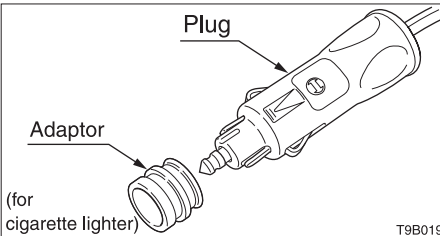



Radio

Operating precautions

- To ensure safe operation of the machine, always be sure to keep the volume of the radio down to a level where you can easily hear sounds from outside the machine.
- Do not keep the radio playing for long periods of time with the engine stopped. Doing so will drain the battery of its charge and make it difficult or impossible to restart the engine.
- Be careful not to allow water or other liquids to come into contact with the radio . Doing so may result in it being rendered inoperable.
- Be careful not to insert cassette tapes backward. Doing so may damage the cassette player. Insert tapes with the head of the tape facing to the right.
- Always remove the cassette from the player when not in use.

Names of components

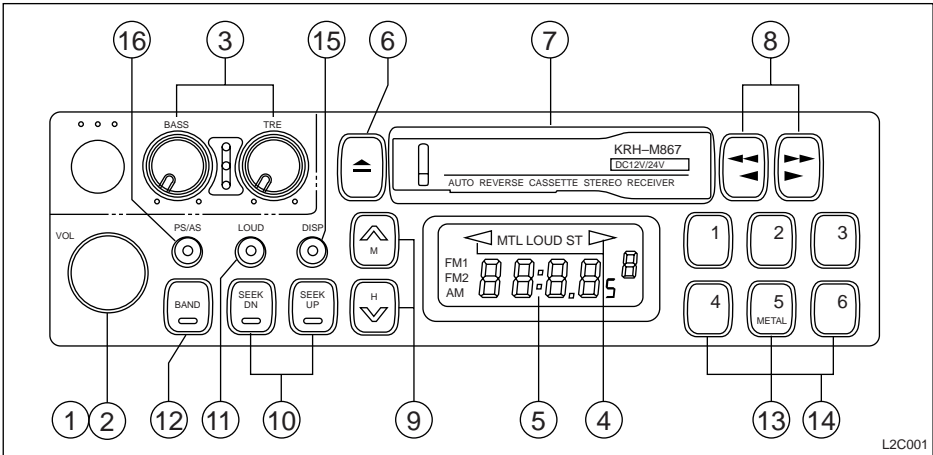

(1) (2) Power switch / volume control knob

Turn this knob clockwise. The “click” sound indicates that the power supply is turned on. Further turning increases the speaker volume. If a tape is loaded in the radio, eject the tape to switch to the radio.

(3) Tone control

- Bass control knob
- Treble control knob



(4) Program indicators

Indicates tape direction. When ► lamp is on. Upper side of a tape is playback, ◀ indicates playback of lower side.

(5) Display

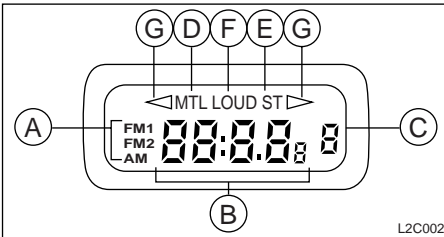

- (A) Band
- (B) Time / Frequency
- (C) Memory channel (1–6)
- (D) Metal
- (E) FM Stereo
- (F) Loudness
- (G) Tape direction

(6) Eject button

Push this button to eject the cassette tape.

- To change over to radio while listening to a cassette tape, press the EJECT button to stop the tape and the system will automatically change over to radio.

(7) Cassette door

Insert the cassette tape with the exposed magnetic tape side facing to the right.

- Simply insert a tape to change over to the cassette tape mode while listening to the radio.

(8) Fast-forward / rewind / program changeover button

Fast-forward

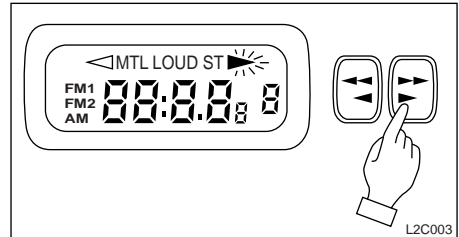

Fast-rewind / Stop

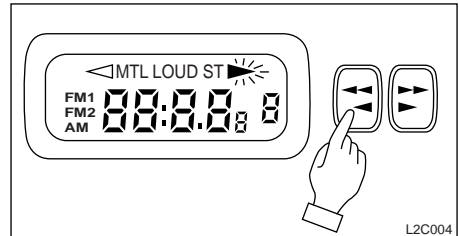

To fast-forward the tape, push the button matching the direction of program indication and to rewind, push the other button. To stop fast-forwarding or rewinding, lightly press the button which is not locked to cancel the operation. The system will then start playing the tape again normally.

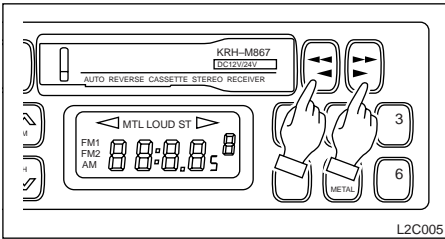

To change the program, press the fast-forward and rewind buttons simultaneously. The direction of tape feed will reverse.

- When the tape ends in one direction, the system automatically reverses the tape and plays the other side.
- To stop fast-forwarding or rewinding, lightly touch the unlocked key. This frees the locked key and normal playing resumes.

(9) Tuner switch (Manual tuning)

Pressing the \wedge shaped TUNER button raises the receiving frequency. Pressing the \vee shaped TUNER button lowers the receiving frequency similarly. Pressing either of these buttons continuously shifts the receiving frequency continuously.

(10) SEEK switch

Pressing the “SEEK” button shifts the receiving frequency in the higher or lower frequency direction before automatically stopping at a position where a station is picked up.

(11) LOUD switch

This button is used to operate the system at a lower sound volume but with enhanced bass and treble sound. (“LOUD” indication appears on the display.)

(12) Band select switch

Pressing the “BAND” button changes over between FM1, FM2 and AM (MW) bands. The display indicates the receiving band name and frequency.

(13) Metal switch

Press the “MTL” (5) button before playing a metal or CrO₂ tape.

The “MTL” indication appears on the display.

(14) Preset switch keys

One station each in the FM1, FM2 and AM(MW) bands, respectively, can be preset for each of these preset keys.

When listening to a preset station, select either of the AM, FM1, FM2 bands using the band select switch, then simply press the number key corresponding to the preset selected station.

The system can memorize 6 stations in AM band and 12 stations in FM bands (FM1: 6 stations and FM2: 6 stations).

Manual Memory

Use manual tuning button or seek tuning button to choose a radio station if a broadcasting station is wanted to be recorded. For 2 seconds press 1–6 preset key when the indication of frequency has already shown and the frequency is recorded. Flash stops and channel starts functioning.

- If the main power supply is interrupted, such as when exchanging machine battery, all presettings will be erased. Repeat the presetting procedure in such case.

**(15) DISP (Time / Frequency) button**

This system is equipped with a clock which can show the accurate time. Even if the radio is off, the clock still shows the time.

(16) PS / AS switch

Push this button 2 sec below will automatically operates to show the memorized station from 1 to 6. The signal scanning start by pushing this button momentarily. When a station is received the scanning automatically stops there for 5 seconds FLASHLY and then resumes scanning. As soon as the desired station is found, press the this button again.

If you will auto memory push this button over 5 sec so initiates a scan of the band. Station frequencies are either stored in order of low of frequency for FM, or in sequence for AM, starting from preset channel 1. If all of the preset channels have not been filled up after one scan, the remaining preset channels are left unchanged, and channel 1 is recalled. Channel 8 flashes during A.

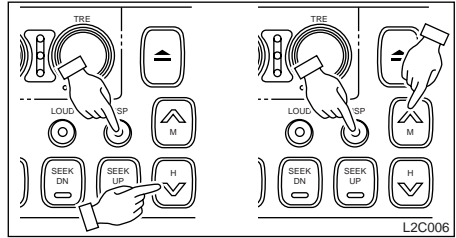
● Set the time

After pressing DISP button, press tuner button ∇ or \triangle to correct the time. Press tuner button ∇ to set the "hour" and tuner button \triangle for setting the "minute". Set the time when the time is shown.



First Auxiliary Hydraulic Lines

WARNING

Oil may spurt out if caps or filters are removed or pipes disconnected before releasing the pressure in the hydraulic system.

- When disconnecting hoses, release the internal pressure before removing.

These lines deliver the hydraulic oil necessary for operating a hydraulic breaker, crusher or other attachments.

< TB153FR >

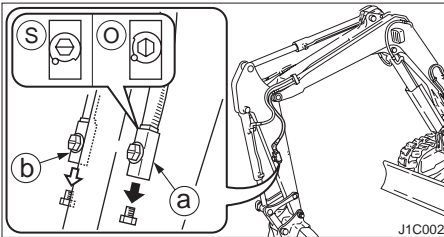

< TB180FR >

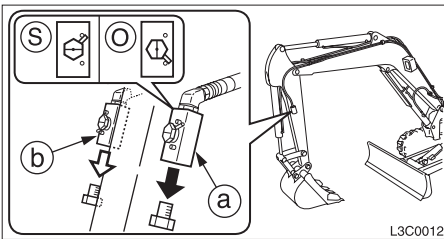

Stop valve (S) : Closed (O) : Open

Connecting the Hydraulic Circuits

To connect the attachment hydraulic lines, use the following procedures:

1. Release the pressure remaining in the lines then close the stop valve.
Refer to "Releasing the residual pressure".

2. Remove the plugs.
3. Connect the attachment hydraulic lines to ports (a) and (b).
When fitted with a hydraulic breaker, connect the return circuit to port (b) and the supply circuit to port (a).
4. Open the stop valves.
When fitted with a hydraulic breaker, open the selector valve (1).
Refer to page 65 "Selector valve".
5. When connecting is complete, purge air from the hydraulic lines.
 - a. Start and run the engine at low idle with no load for 10 minutes.
 - b. With the engine running at low idle operate the auxiliary hydraulic switches repeatedly (approx. 10 times) to purge air from the hydraulic lines.
 - c. Stop the engine and wait for more than 5 minutes until bubbles escape from the hydraulic oil in the tank.

IMPORTANT: Follow the procedures for purging air as instructed by the attachment manufacturer if specified to do so.

6. Check for leaks.

Disconnecting the hydraulic circuits

1. Release the pressure remaining in the lines then close the stop valve.
Refer to "Releasing the residual pressure".
2. Disconnect the lines from ports (a) and (b).
3. Install the plugs.

Releasing the residual pressure

After using the auxiliary hydraulic circuits, pressure remains in the circuits. This is called the residual pressure. Release this residual pressure before disconnecting the lines.

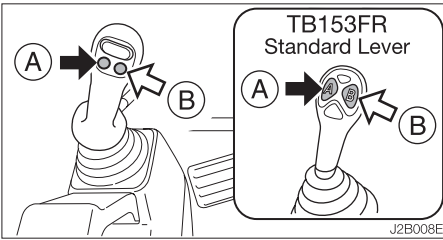

1. Start the engine and press the auxiliary hydraulic button (B).
(The residual pressure is released from the (a) port line, and pressure is generated in the (b) port.)
2. Stop the engine and open the selector valve (1) on the machine body.
(The residual pressure is released from the (b) port line.)

When equipped with accumulator (option) :
Refer to page 204 “Releasing the residual pressure”.

Selector valve

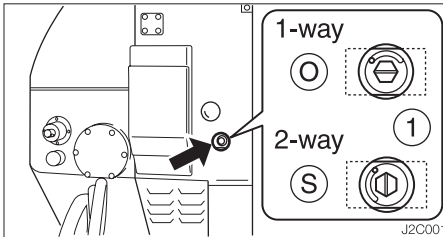

- ⊙: Open When using a hydraulic breaker (1-way flow)
- Ⓢ: Closed When using a reversible attachment (2-way flow)

Change the direction of the hydraulic oil flow by opening or closing the selector valve on the machine body.



OPERATION

Before Starting Operation	68
Starting and Stopping the Engine	
<TB153FR>	70
Starting and Stopping the Engine	
<TB180FR>	72
Machine Operation	74
Operating Procedures	88
Parking the Machine	96
Handling in Cold Weather	97
Handling Rubber Crawlers	98



Mounting and Dismounting

WARNING

- **Do not jump on or off the machine. Never attempt to mount or dismount a moving machine.**
- **When mounting and dismounting the cab, first open the door fully to the locked position and check that it does not move. (For machines with cabs)**

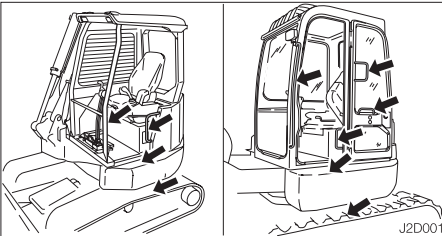

- **Always face the access system and maintain a three point contact with the recommended handrails and steps while getting on and off the machine. Keep steps and platform clean.**
- **Never use the safety lock lever or control levers as hand holds.**

Walk-Around Inspection

Perform the walk-around inspections once a day before starting the engine the first time that day.

Perform the inspections as described under “Maintenance - Walk-Around Inspection” (pages 118 and 119).

Daily Inspection

Perform the daily inspections once a day before starting the engine the first time that day.

Perform the inspections as described under “Maintenance - Daily Inspection” (pages 120 to 124).

**Before Starting the Engine**

1. Adjust the seat for a comfortable operating position.
2. Fasten the seat belt.

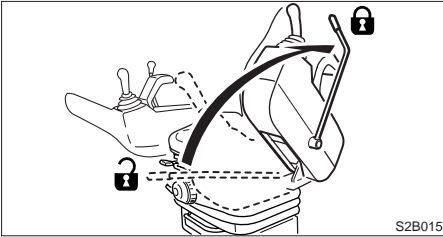

3. Check that the safety lock lever is in the locked position.

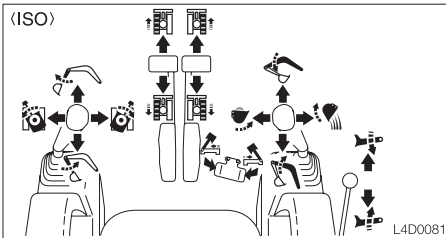

4. Check that all the levers and pedals are in the neutral position.

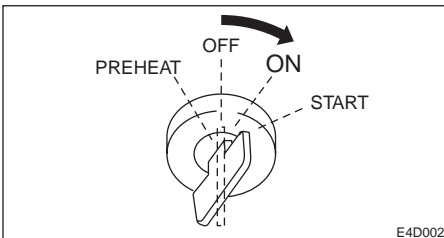

5. Insert the key into the starter switch, turn it to the ON position, then perform the following inspection :

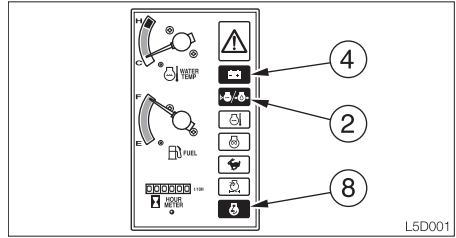

- All the warning lamps flash and an alarm is sounded for 2 seconds. The meters also start functioning. After 2 seconds, only the battery charge warning lamp (4) and engine oil pressure / coolant level warning lamp (2) flash, and the other lamps turn off.
- < TB180FR > : Check that the decel. lamp (8) is lit.
- Turn the light switch to check that the boom light, front light and meter light turn on.
- Check the fuel level.

If a lamp does not light or the alarm is not sounded, the bulb may be burnt out or a wire may be damaged. Contact a Takeuchi sales or service outlet for repairs.

**Starting the Engine****⚠ WARNING**

- Clear the area of all persons.
- Sound horn to alert everyone around the machine.

IMPORTANT: Do not run the starter motor for more than 15 consecutive seconds. If the engine fails to start, wait for 30 seconds to protect the battery, and then try again to start the engine.

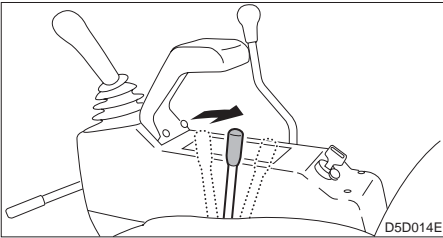
Normal Starting

1. Pull the throttle lever to the middle position.

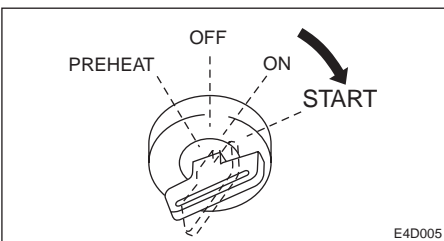

2. Turn the key to the START position and start the engine.
3. Once the engine starts, release the key. The key automatically returns to the ON position.
4. Check that the warning lamps are off.
5. Return the throttle lever and warm up the engine.
Refer to page 71 "Warming Up the Engine".

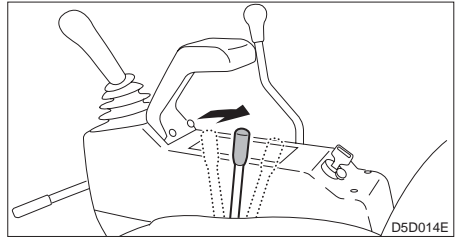
Starting in Cold Weather

1. Pull the throttle lever to the middle position.

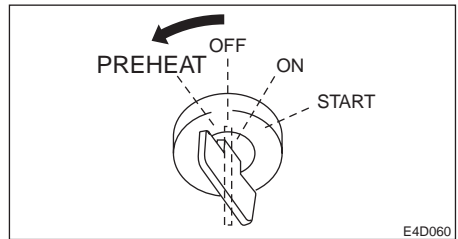

2. Turn the key to the PREHEAT position and hold it there while the glow lamp is lit (about 15 seconds).
3. After the glow lamp turns off, then turn it to the START position and start the engine.
4. Once the engine starts, release the key. The key automatically returns to the ON position.
5. Check that the warning lamps are off.
6. Return the throttle lever and warm up the engine.
Refer to page 71 "Warming Up the Engine".



Warming Up the Engine

IMPORTANT: Avoid racing the engine until it is warmed up.

Do not warm up the engine for long periods of time (20 minutes or more).

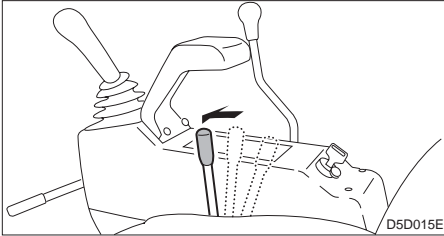

1. Return the throttle lever, then idle the engine and run it for about 5 minutes with no load.

Stopping the Engine

IMPORTANT: Do not stop the engine suddenly when operating with heavy loads or at maximum speed. Doing so may cause the engine to overheat or seize. Never bring the engine to a sudden stop except in the case of a true emergency.

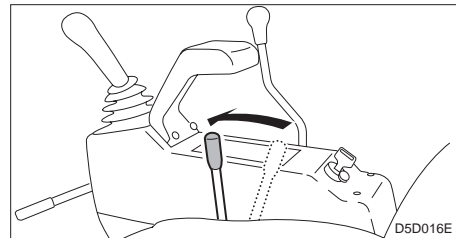
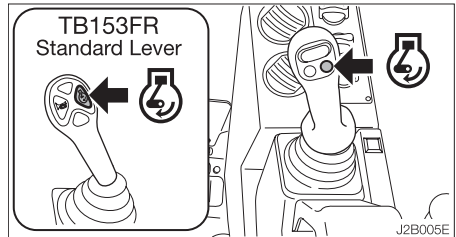

1. Press the decel. button or return the throttle lever.
2. Idle the engine for about 5 minutes to gradually let it cool.

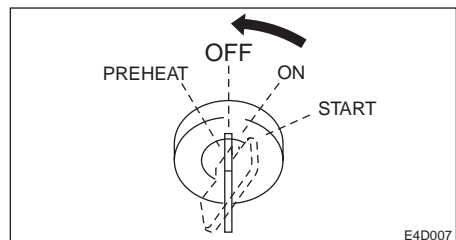

3. Turn the key to the OFF position to stop the engine.

**Starting the Engine****⚠ WARNING**

- Clear the area of all persons.
- Sound horn to alert everyone around the machine.

IMPORTANT: Do not run the starter motor for more than 15 consecutive seconds. If the engine fails to start, wait for 30 seconds to protect the battery, and then try again to start the engine.

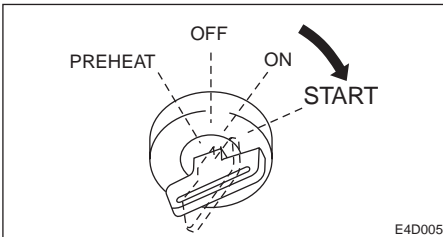
Normal Starting

1. Turn the key to the START position and start the engine.
2. Once the engine starts, release the key. The key automatically returns to the ON position.
3. Check that the warning lamps are off.
4. Warm up the engine :
Refer to page 73 "Warming Up the Engine".

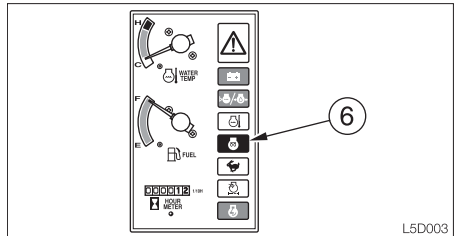
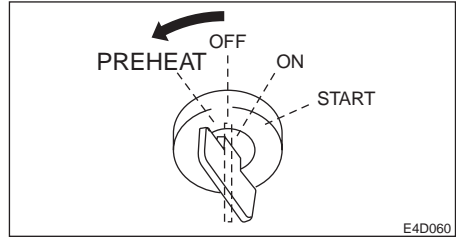
Starting in Cold Weather

1. Turn the key to the PREHEAT position and hold it there while the glow lamp (6) is lit (about 15 seconds).
2. After the glow lamp (6) turns off, then turn it to the START position and start the engine.
3. Once the engine starts, release the key. The key automatically returns to the ON position.
4. Check that the warning lamps are off.
5. Warm up the engine :
Refer to page 73 "Warming Up the Engine".



Warming Up the Engine

IMPORTANT: Avoid racing the engine until it is warmed up.

Do not warm up the engine for long periods of time (20 minutes or more).

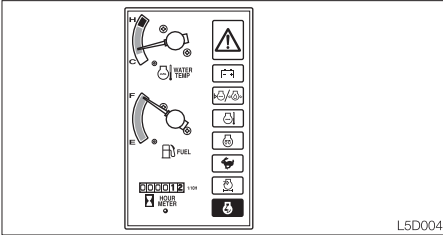

L5D004

1. Idle the engine and run it for about 5 minutes with no load.

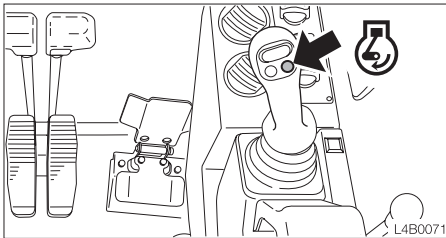

L4B0071

2. Press the decel. button to return to the engine speed set with the throttle controller.

Stopping the Engine

IMPORTANT: Do not stop the engine suddenly when operating with heavy loads or at maximum speed. Doing so may cause the engine to overheat or seize. Never bring the engine to a sudden stop except in the case of a true emergency.

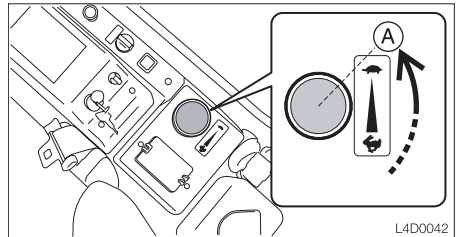

L4D0042

1. Press the decel. button or return the throttle controller.
2. Idle the engine for about 5 minutes to gradually let it cool.

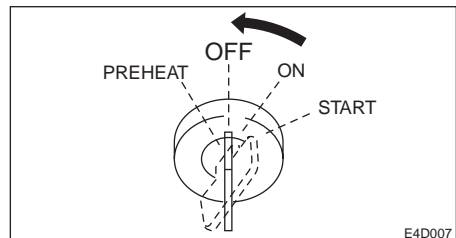

E4D007

3. Turn the key to the OFF position to stop the engine.



Lever Pattern (ISO Pattern)

WARNING

- Be careful to check which pattern of lever control arrangement you are operating with before beginning operations.
- The explanations in this manual are for the ISO pattern.

(ISO)

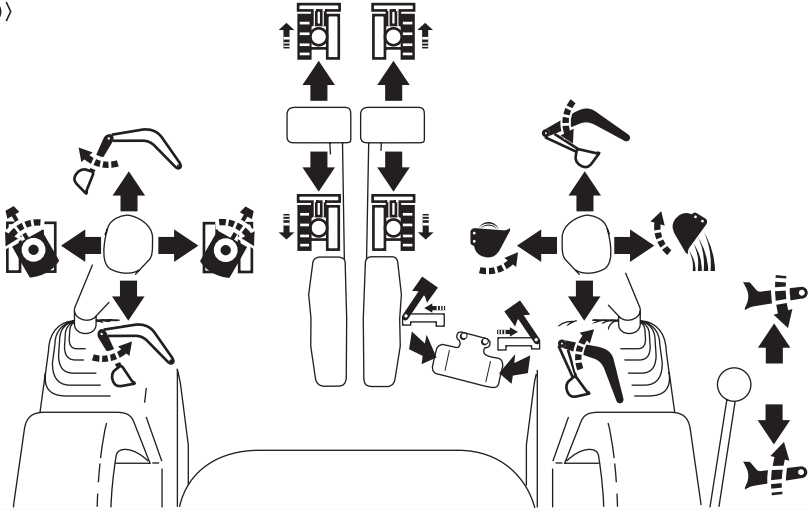

L4D0111

	Left Crawler Forward		Right Crawler Forward
	Left Crawler Reverse		Right Crawler Reverse
	Arm Out		Boom Lower
	Arm In		Boom Raise
	Upperstructure Left Slew		Bucket Load
	Upperstructure Right Slew		Bucket Dump
	Boom Offset Left		Dozer Blade Lower
	Boom Offset Right		Dozer Blade Raise



Lever Pattern (JCB Pattern)

WARNING

- Be careful to check which pattern of lever control arrangement you are operating with before beginning operations.
- The explanations in this manual are for the ISO pattern.

<JCB>

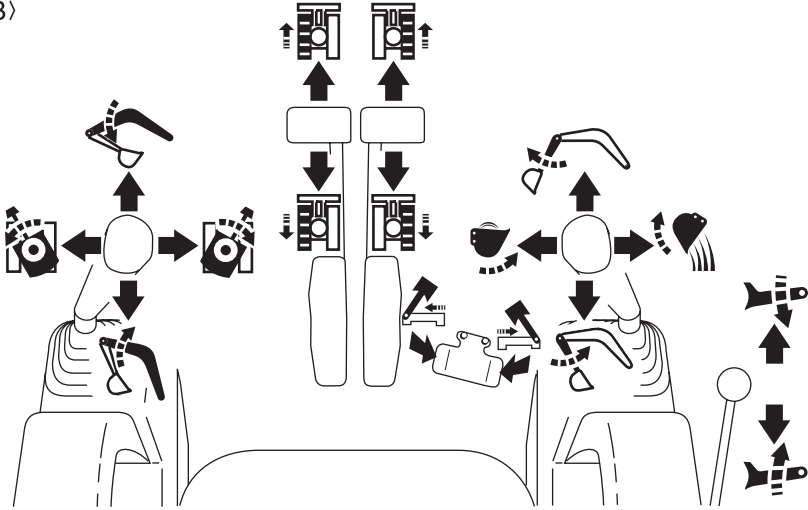

L4D0071

	Left Crawler Forward		Right Crawler Forward
	Left Crawler Reverse		Right Crawler Reverse
	Boom Lower		Arm Out
	Boom Raise		Arm In
	Upperstructure Left Slew		Bucket Load
	Upperstructure Right Slew		Bucket Dump
	Boom Offset Left		Dozer Blade Lower
	Boom Offset Right		Dozer Blade Raise



Warming Up the Machine (Hydraulic Oil)

⚠ WARNING

Operating the working equipment without warming up the machine (hydraulic oil) is dangerous, as response will be slow and the equipment may move in unexpected ways. Be sure to sufficiently warm up the machine.

IMPORTANT: Do not operate the levers suddenly when the hydraulic oil temperature is below 20°C (68°F). The proper hydraulic oil temperature during operation is 50 to 80°C (122 to 176°F), but if operations must be performed at lower temperatures, heat up the hydraulic oil to at least 20°C (68°F).

Normal Warm-up < TB153FR >

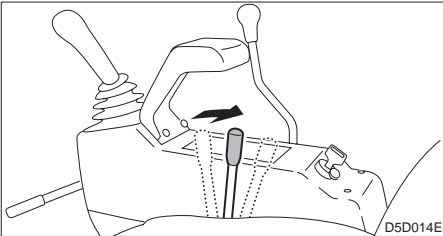

D5D014E

1. Pull the throttle lever to the middle position.

< TB180FR >

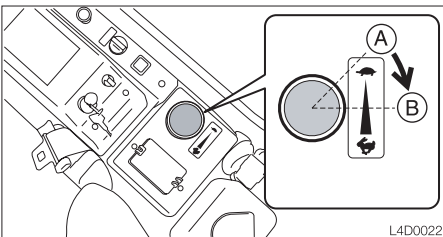

L4D0022

1. Turn the throttle controller to the middle position (B).
2. Run the engine at medium speed for about 5 minutes with no load.

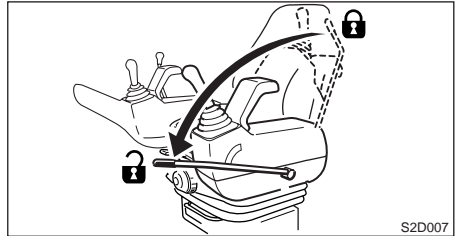

S2D007

3. Fully lower the safety lock lever to disengage the lock and raise the pedal lock to disengage the lock.

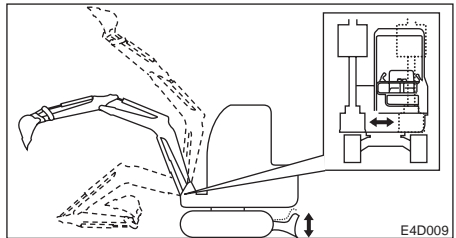

E4D009

4. Lift the bucket from the ground.
5. Extend and retract each of the cylinders several times with no load.

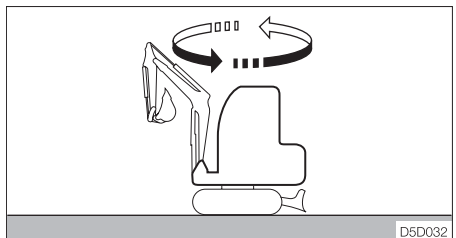

D5D032

6. Slew slowly left and right several times.

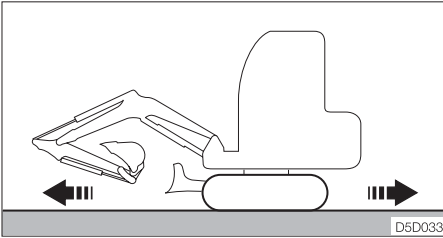

7. Travel slowly forward and backward several times.

Warming Up in Cold Weather

1. Perform the normal warm-up procedure.

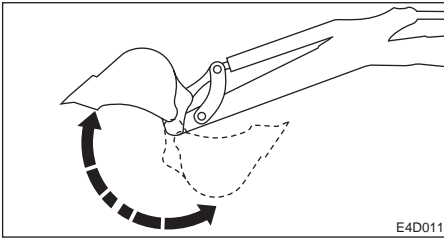

2. Set the bucket cylinder at the stroke end and keep it there.
Do not do this for more than 30 seconds.
3. Repeat step 2 until the bucket operating speed is normal.

Inspection After Warm-up

After warming up the engine and hydraulic oil, perform the checks and inspections described below, and repair if there is a problem.

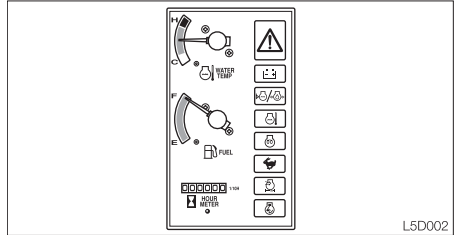

1. Check that the warning lamps and meters are as follows :
 - Are all the warning lamps off?
 - Is the water temperature gauge's needle within the green range?
2. Check that there are no irregularities in the exhaust color, sound and vibrations.

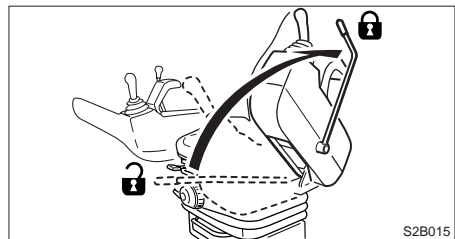

3. Raise the safety lock lever to engage the lock and check that the operating, offset, dozer blade and travel levers are locked.
 - < TB153FR >: Note that the dozer blade control is not locked, even when the safety lock lever is set to the lock position.
4. Perform the inspection operations described below and check that the bucket, arm and boom do not touch the cab when the boom or bucket is moved near the cab and stops automatically.

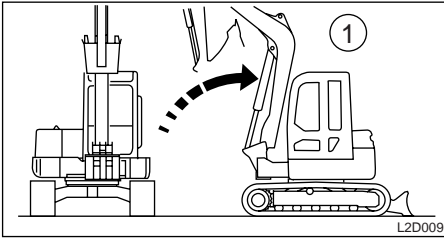

- (1) Offset the boom to the front of the operator's seat and move the boom near the cab.

Offset the boom to the right and move the bucket near the cab.

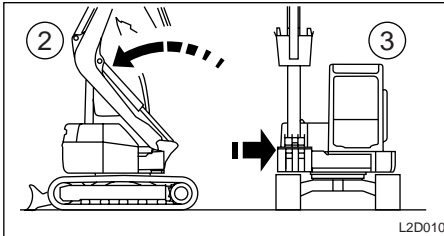

- (2) Offset the boom fully to the right and check that it can be set to the maximum rear inclination.
- (3) Offset to the left in the posture in (2) above

Operation when the boom has stopped automatically

1. If the boom has stopped while rising:
Operate the boom downward.
2. If the boom has stopped while offsetting to the left:
 - a. Operate the boom downward to move it outside the automatic stop range.
 - b. Offset to the left.
Offsetting to the right is possible regardless of the boom's posture.



Operating the Travel Levers

WARNING

- Never allow anyone to enter the slewing (swing) radius and machine path.
- Signal your intention to move by sounding the horn.
- There are blind spots to the rear of the machine.

If necessary, swing the cab around before backing up to check that the area is safe and clear.

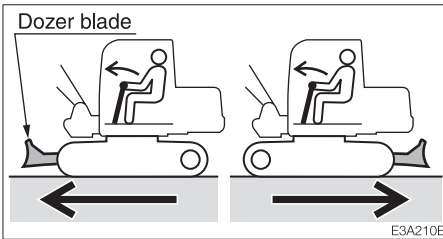

- Before operating the travel levers, check to make sure that the dozer blade is to the front of the operator's seat. **BE AWARE** that when the dozer blade is to the rear of the operator's seat, the travel levers operate in the opposite direction to when the dozer blade is in the front.
- Remove any obstacles in the machine's path.

Traveling Forward and Backward

1. Increase the engine speed.

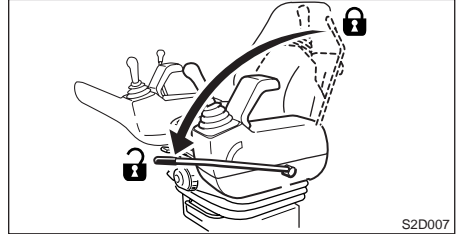

2. Fully lower the safety lock lever to disengage the lock.

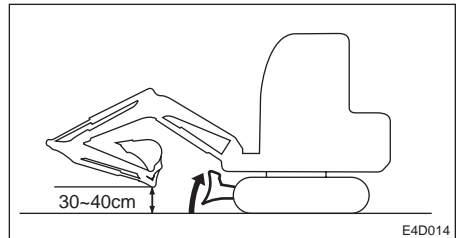

3. Fold the hoe attachment and lower it to 30 to 40 cm (12 to 16 in.) above the ground.
4. Lift the dozer blade.
5. Operate the left and right travel levers as described below.

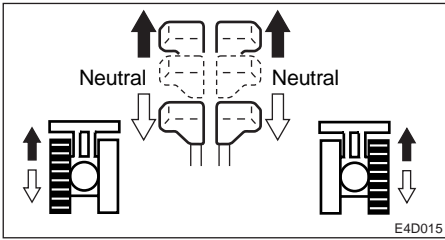

When the dozer blade is in front of the operator's seat :

- ➔ To move forward :
Tilt the levers forward.
- ⇨ To move backward :
Tilt the levers backward.

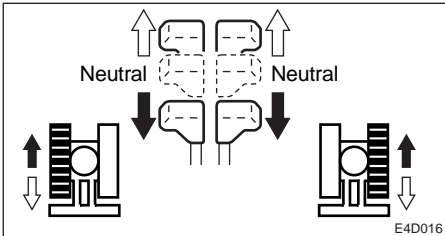

When the dozer blade is behind the operator's seat :

- ➔ To move forward :
Tilt the levers backward.
- ⇨ To move backward :
Tilt the levers forward.

Traveling in 2nd (High) Speed

! WARNING

When a load greater than a set value is applied during 2nd speed (high speed) travel, the speed will automatically slow down by switching to 1st speed (low speed). Thereafter, when the load becomes lighter, the speed will increase by returning to 2nd speed (high speed). Exercise due caution since the travel speed changes automatically.

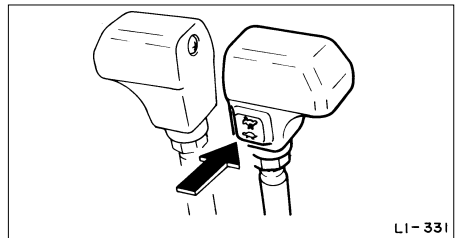

Press the travel speed switch on the right travel lever to switch to 2nd (high) speed, and press it again to return to 1st speed (low speed).

Pivot Turn

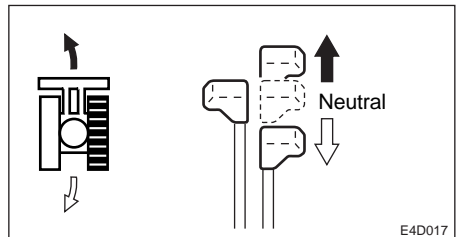

Turning to the left when stopped :

- ➔ To turn forward to the left :
Tilt the right lever forward.
- ⇨ To turn backward to the left :
Tilt the right lever backward.

To turn to the right, operate the left lever in the same way.

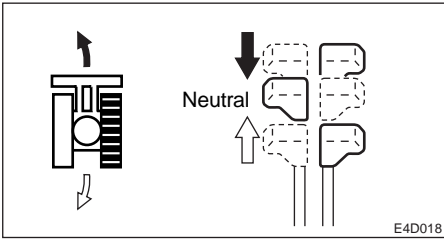

Turning to the left while traveling :

➔ To turn left while traveling forward :

Set the left lever to neutral.

⇨ To turn left while traveling backward :

Set the left lever to neutral.

To turn to the right while traveling, operate the right lever in the same way.

Spin Turn

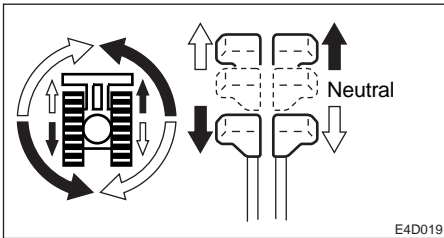

➔ To spin left :

Tilt the left lever backward and the right lever forward.

⇨ To spin right :

Tilt the right lever backward and the left lever forward.

Stopping Travel

! WARNING

- Park the machine on firm, level ground and apply the parking device. If you must park on a slope or incline, block the machine securely to prevent movement.
- If any controls should be touched accidentally when the safety lock lever is lowered, the machine will move suddenly, and cause serious injury or death.
- < TB153FR > : Note that the dozer blade control is not locked, even when the safety lock lever is set to the lock position. Do not touch this control accidentally.

! CAUTION

Never bring the machine to a sudden stop except in the case of a true emergency. Stop as gently as possible.

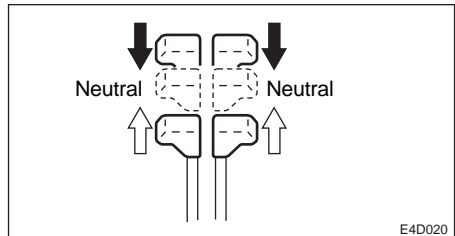

1. Slowly set the left and right travel levers to the neutral position. The machine stops.



Attachment Interference Switch / Interference Prevention System

⚠ WARNING

- All attachments other than a bucket should be used with the AIS set to the M mode.
- Ensure that all buckets used in the standard position are no longer than a standard bucket when measured from pin to tooth.
- Failure to properly set the Attachment Interference Switch can result in equipment damage, serious injury, or death.
- Do not disassemble or damage the sensors installed on the boom and main body. Doing so may cause the Interference Prevention System to malfunction. If there is a problem, contact a Takeuchi sales or service outlet for inspection or repair.

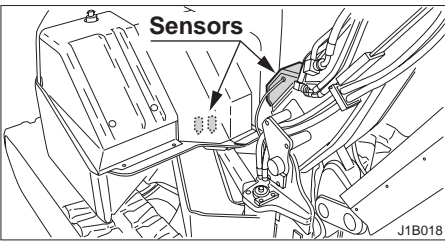

- The interference prevention system may not function properly if attachments other than Takeuchi approved attachments are installed. Do not install other non-approved attachments.

The Attachment Interference Switch (AIS) allows the operator to select the attachment size used on the excavator. The Interference Prevention System uses the operator's AIS selection to limit the movement of the boom (raising, lowering, and offsetting) to prevent the cab from being struck by the boom, attachment, or the material being handled. The Interference Prevention System (IPS) is automatically set to the M mode when the engine is started to provide the maximum operator protection.

< TB153FR >

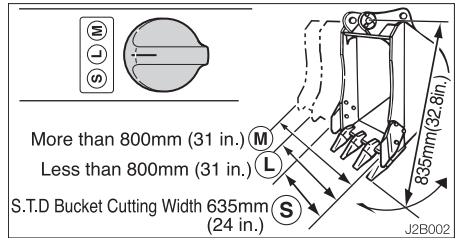

< TB180FR >

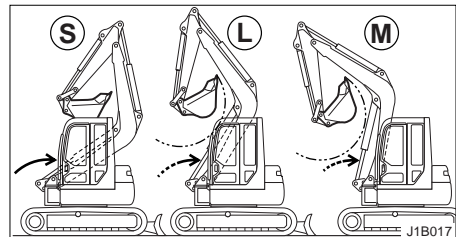
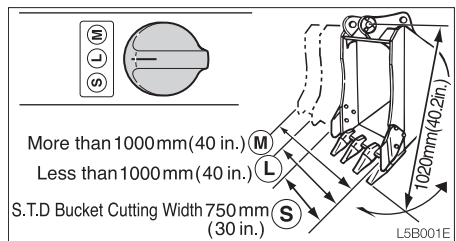



To properly set the AIS :
Reset the AIS to the M position
Select the appropriate attachment width

< TB153FR >

- S** Standard bucket attachment less than 635mm (24 inches) wide
- L** Bucket attachment more than 635mm (24 inches) and less than 800mm (31 inches) wide
- M** Bucket attachment more than 800mm (31 inches) wide or any other approved attachment

< TB180FR >

- S** Standard bucket attachment less than 750mm (30 inches) wide
- L** Bucket attachment more than 750mm (30 inches) and less than 1000mm (40 inches) wide
- M** Bucket attachment more than 1000mm (40 inches) wide or any other approved attachment

Operate excavator

The minimal front radius feature is only available for the standard bucket attachment 635mm (24 inches) TB153FR / 750mm (30 inches) TB180FR or smaller.

**Operating the Working Equipment****⚠ WARNING**

- Be careful to check which pattern of lever control arrangement you are operating with before beginning operations.
- The explanations in this manual are for the ISO pattern.

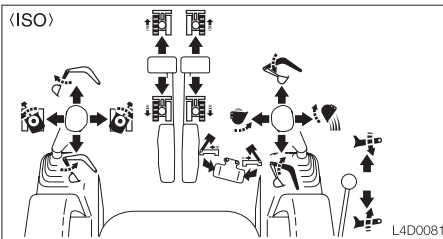

Use the right operating lever to operate the boom and bucket.

Use the left operating lever to operate the arm and for slewing.

Return the operating levers to the neutral position to stop the hoe attachments.

1. Fully lower the safety lock lever to disengage the lock.
2. Raise the pedal lock to disengage the lock.

Slewing**⚠ WARNING**

Check the surrounding area for safety before slewing.

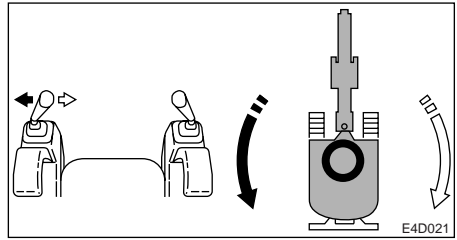

➔ To slew left :

Tilt the left operating lever to the left.

⇨ To slew right :

Tilt the left operating lever to the right.

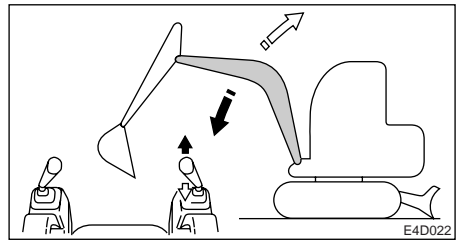
Operating the Boom

➔ To lower the boom :

Tilt the right operating lever forward.

⇨ To raise the boom :

Tilt the right operating lever backward.

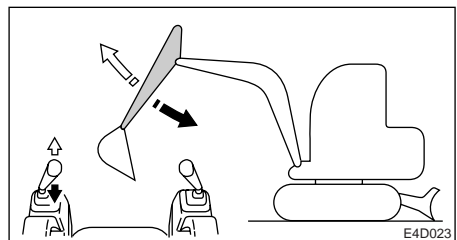
Operating the Arm

➔ To contract the arm :

Tilt the left operating lever backward.

⇨ To extend the arm :

Tilt the left operating lever forward.



Operating the Bucket

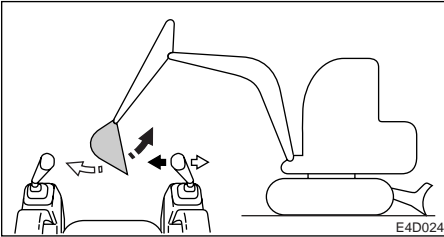

- ➔ To dig :
Tilt the right operating lever to the left.
- ⇨ To dump :
Tilt the right operating lever to the right.

Operating the Boom Offset

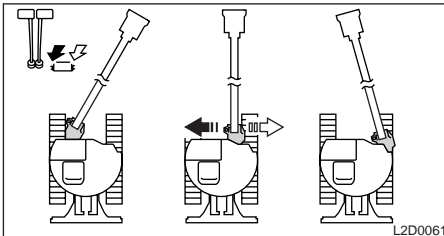

- ➔ To offset left :
Press the left side of the pedal.
- ⇨ To offset right :
Press the right side of the pedal.

Operating the Dozer Blade

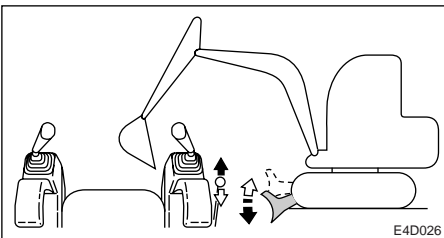

- ➔ To lower the dozer blade :
Tilt the lever forward.
- ⇨ To raise the dozer blade :
Tilt the lever backward.



Operating the First Auxiliary Hydraulics

Use this to operate a breaker, crusher or other attachment.

Two methods of operation are permitted: operation with the auxiliary hydraulic buttons and operation with the slider switch (proportional control).

< TB153FR >

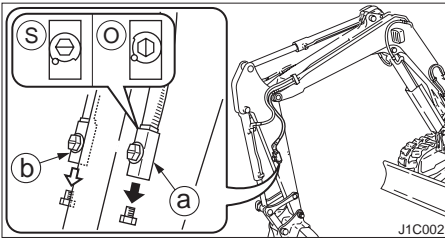

< TB180FR >

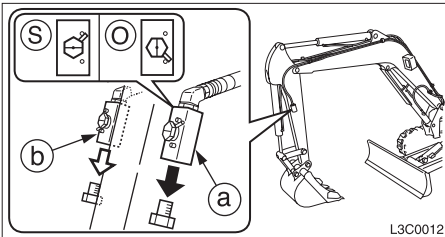

Operating With the Slider Switch (Proportional Control)

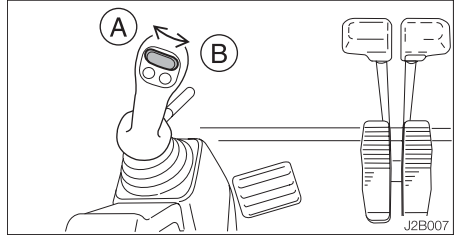

- ➔ To deliver hydraulic oil to port (a): Move the switch to the left (A).
- ⇨ To deliver hydraulic oil to port (b): Move the switch to the right (B).

Operating With the Auxiliary Hydraulic Buttons

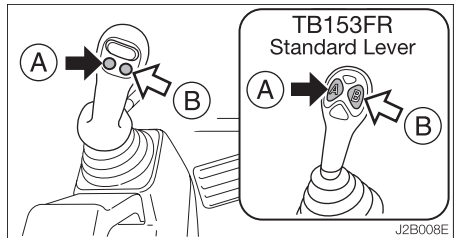

- ➔ To deliver hydraulic oil to port (a): Press (A).
- ⇨ To deliver hydraulic oil to port (b): Press (B).

MEMO



Prohibited Operations

WARNING

- Do not operate on base rock (hard or soft).
- Do not slew (swing) while traveling. If you must operate the hoe attachment while traveling, operate at speeds slow enough so you have complete control at all times.

Do not perform breaking or leveling operations using slew force

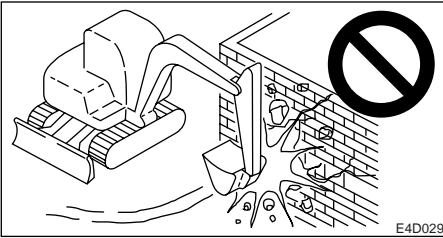

Do not break down walls or level ground using slew force. Also, do not dig the bucket teeth into the ground during slewing. Doing so will damage the hoe attachment.

Do not Dig while Traveling

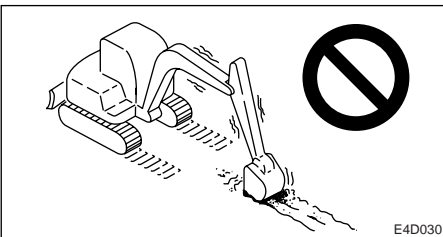

Do not dig the bucket into the ground and use the traveling force to dig.

Be Gentle on the Hydraulic Cylinders

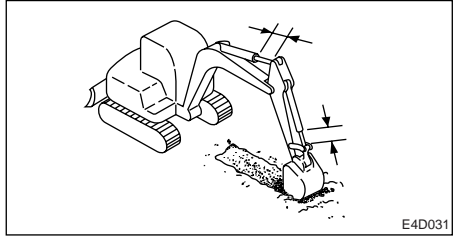

Do not extend the hydraulic cylinders to the stroke ends. Operate them with leeway.

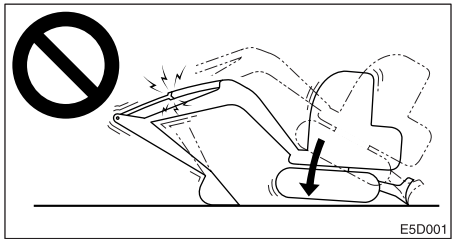

Do not support the machine body with the hoe attachment as it is lowering with the arm cylinder fully extended. Doing so concentrates the load on the arm cylinder and could damage the arm cylinder.

Do not Drive Piles with the Bucket or Dig with it Using Shock Force

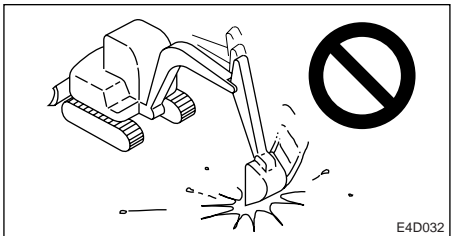

Doing so will shorten the service life of the hoe attachment. Use hydraulic force to dig.



Do not Perform Operations Using the Machine's Dropping Force

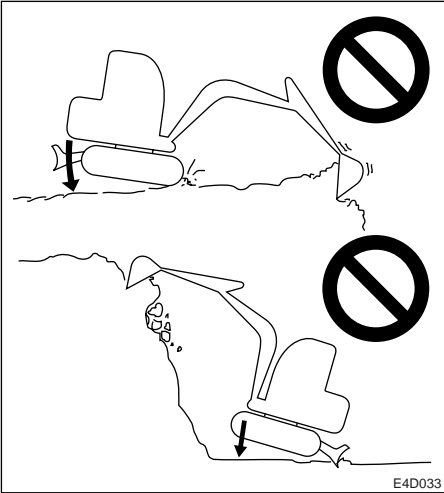

Putting excessive strain on the machine will shorten its service life. Use the hydraulic force of the cylinders and always dig with shallow, long strokes.

Digging Base Rock

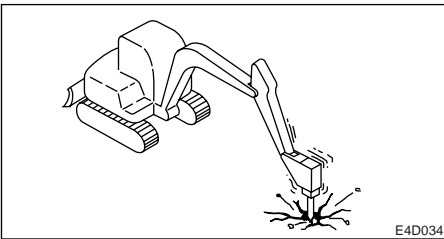

For hard base rock, break the rock up into small pieces with a breaker, etc., before digging. This prevents damage to the machine and is thus more economical in the end.

Caution on Exposing the Dozer Blade to Shocks

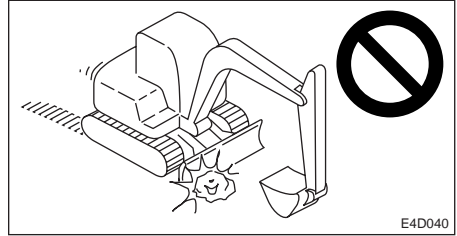

Hitting the dozer blade against rocks, etc., could damage the dozer blade or the blade cylinder.

Caution on Folding the Hoe Attachment

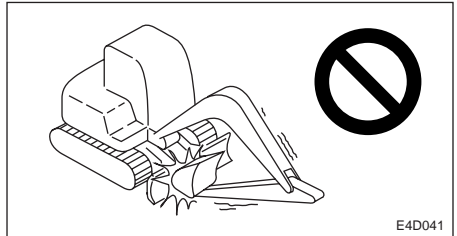

Be careful not to hit the bucket or dozer blade when folding the hoe attachment.

Do not use the Dozer Blade as an Outrigger

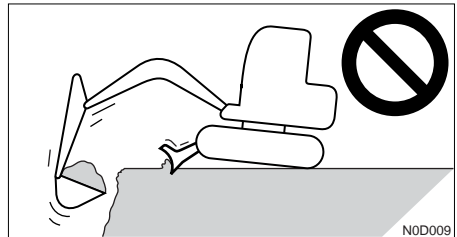



Pay Attention to the Dozer Blade when Digging

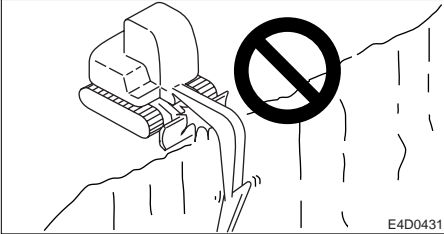

When digging deeply with the dozer blade positioned at the front, be careful that the boom cylinder and bucket do not hit the dozer blade.

Operate with the dozer blade at the rear whenever possible.

Caution on Digging Down with the Dozer Blade

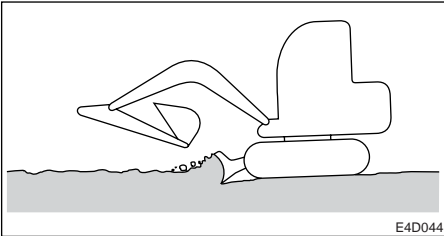

This dozer blade is designed for simple earth pushing. Do not dig down deeply with the dozer blade. Doing so could damage the dozer blade and lower body.



Cautions on Operating

Cautions on Traveling

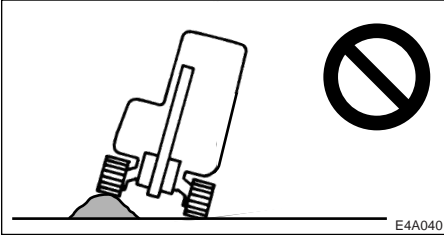

Traveling over obstacles (rocks, stumps, etc.) may subject the body to strong shocks and result in damage. Avoid traveling over obstacles whenever possible. If you must do so, keep the hoe attachment near the ground, travel at low speed, and go over the obstacle at the center of the crawler.

Cautions on Traveling in 2nd (High) Speed

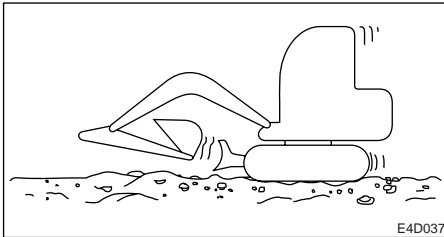

On uneven ground, travel at low speed and avoid accelerating, stopping or changing directions abruptly. Also, when traveling in 2nd speed, do so with the dozer blade at the front.

Cautions on Use in Water

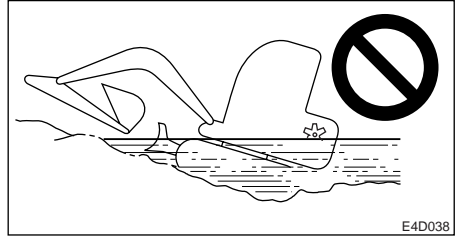

If you leave water at a sharp angle, the rear of the machine may be submerged, exposing the radiator fan to water and damaging them. Do not let the rear of the machine get submerged.

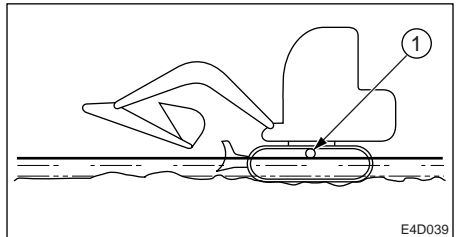

- Allowable water depth

In water, only use the machine up to a depth at which the water comes up to the middle of the carrier roller (1).

- When greasing places used under water for long periods of time, apply enough grease so that the old grease is expelled.
- Never submerge the slew bearing or main body in water or sand. If the slew bearing or main body should get submerged, contact a Takeuchi sales or service outlet for inspection.



Cautions on Traveling on Slopes

WARNING

- Never exceed the machine's stability capabilities (maximum gradeability – 30°, lateral tipping angle – 15°). Also note that when actual working area conditions are poor the machine's stability capabilities may be lower.
- When traveling on slopes or grades, lower the bucket to a height of 20 to 30 cm (8 to 12 in.) off the ground. In emergencies, lower the bucket to the ground and stop the machine.
- When traveling on slopes or grades, move slowly in first gear (low speed).
- Do not travel down slopes in reverse.

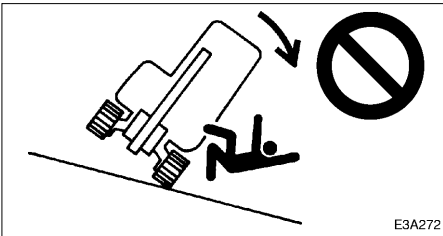

- Do not change directions or cross slopes sideways. First return to a flat surface then redirect the machine.
- On grass, dead leaves, wet metal or frozen surfaces, the machine may slide sideways even on very gentle slopes. Make sure the machine never faces sideways with respect to the slope.

Traveling Posture Traveling up slopes

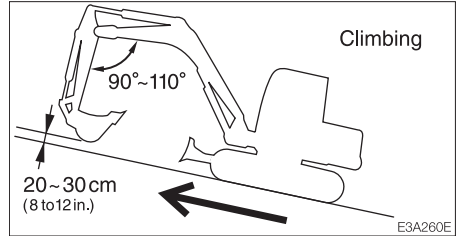

When traveling up slopes at an angle of 15° or greater, travel in the posture shown in the diagram above.

Traveling down slopes

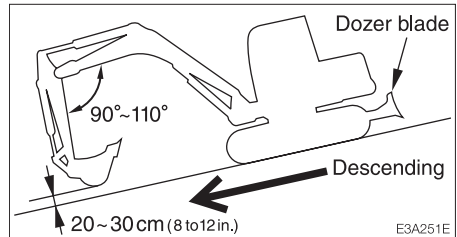

When traveling down slopes at an angle of 15° or greater, lower the engine speed and travel in the posture shown in the diagram above.

Braking when traveling down slopes

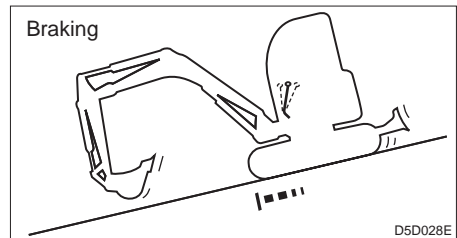

When traveling down slopes, the brakes are applied automatically when the travel levers are returned to the neutral position.



If the crawlers slip

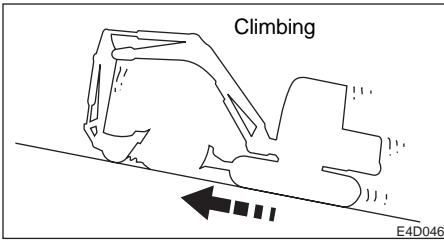

If the crawlers slip while traveling up a slope, use the pulling force of the arm to climb the slope.

If the engine stops

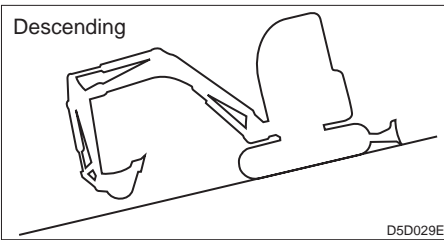

If the engine stops when traveling down a slope, set the travel levers to the neutral position, stop the machine, then start the engine.

Do not open the door while traveling on slopes

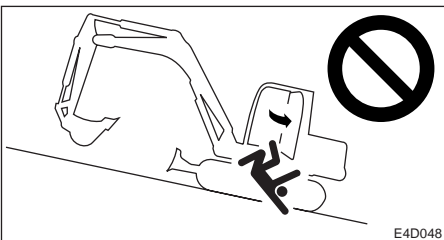

Opening the door while traveling on slopes is dangerous, as the force required to open and close the door changes abruptly. Always keep the door closed when traveling on slopes.



Getting Out of Mud

If the machine gets stuck in mud, use the procedure below to get it out.

If one crawler is stuck



1. Slew the bucket to the side which is stuck.
2. Set the arm and boom to an angle of 90 to 110°.
3. Press the bottom of the bucket (not the teeth) against the ground.
4. Place a plank, etc., under the lifted crawler.
5. Lift the bucket and slowly move out of the mud.

If both crawlers are stuck

1. Perform steps 1 to 4 above for both crawlers.
2. Dig the bucket into the ground in front of the machine.
3. Pull with the arm and travel forward simultaneously to slowly move out of the mud.

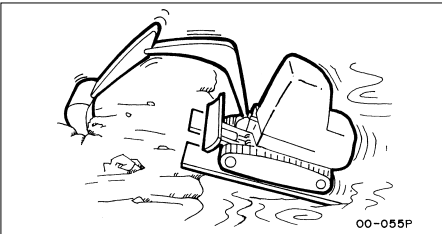

Operations Possible with this Machine

Excavating

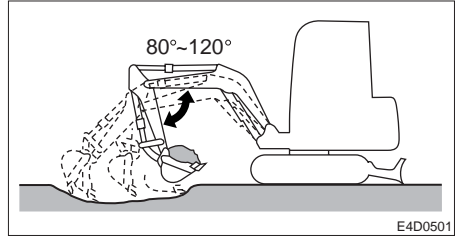

1. Set the dozer blade on the side opposite the side you want to dig on.
2. Use the arm and bucket and dig with shallow, long strokes. The digging force is strongest when the boom and arm angle is 80 to 120°. Use this angle for effective digging.

Digging Ditches

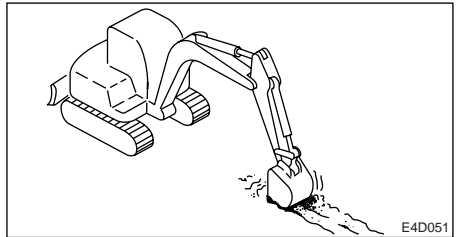

Mount a bucket suited for digging ditches and set the crawlers parallel to the ditch to be dug for greater efficiency.

When digging wide ditches, dig the sides first, the center later.



Digging Side Ditches

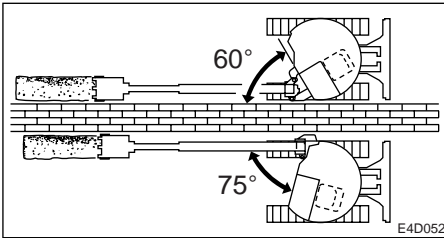

Use the boom swing function to dig side ditches as shown in the diagram.

Loading

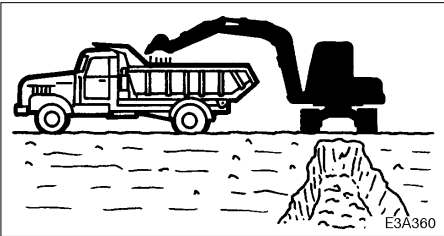

When loading dirt in a truck, starting from the back of the truck's bed makes for easier loading and increases the amount of dirt that can be loaded.

Also, use a small slewing angle for greater efficiency.

Leveling

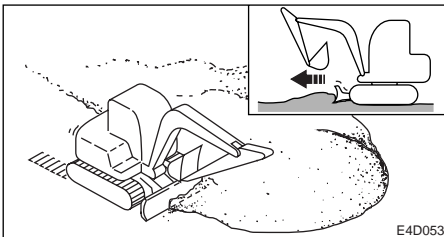

1. Bring the hoe attachment close to the body.
2. Gradually remove the dirt from the side of the mound.

3. Once the mound is low, remove the dirt from the top. If the load on the body is too heavy, adjust by raising or lowering the dozer blade.

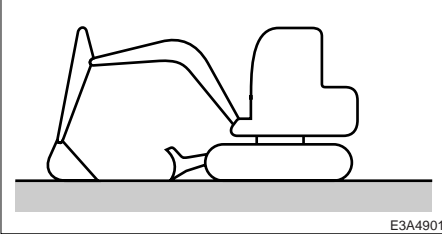
**Parking****⚠ WARNING**

- **Park the machine on firm, level ground and apply the parking device.**
- **Before leaving the operator's seat, raise the safety lock lever to engage the lock and stop the engine. If any controls should be touched accidentally when the safety lock lever is lowered, the machine will move suddenly, and cause serious injury or death.**

1. Set the left and right travel levers to the neutral position.
2. Return the throttle lever or controller and idle the engine at low speed.
3. Lower the bucket and dozer blade to the ground.
4. Raise the safety lock lever to engage the lock.
5. Stop the engine and remove the key.
Refer to page 71 or 73 "Stopping the Engine".

Inspection and Checks After Stopping the Engine

1. Check for oil and water leakage and inspect the working equipment, covers and lower body. If any irregularities are found, repair.
2. Fill the fuel tank.
Refer to page 122 "Inspecting the Fuel Level".
3. Remove any paper scraps or dirt from the engine room.
4. Remove any mud from the lower body.

Locking

Be sure to lock the following places :

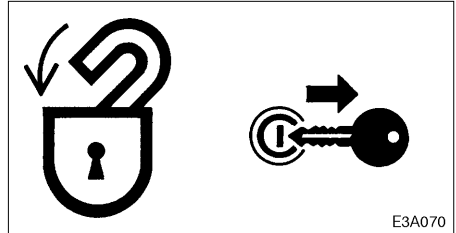

- Cab door
- Fuel filler cap
- Rear cover
- Tool box
- Manual storage compartment (Canopy)



Preparing for Cold Weather

In cold weather, it may be difficult to start the engine and the coolant may freeze. Make the preparations described below.

Changing the Fuel and Lubricant

Change the fuel, hydraulic oil and engine oil to types suited for cold conditions.

Refer to page 110 "Lubricant and Fuel Chart".

Engine Coolant



WARNING

The coolant is combustible. Keep flames away.

Use long-life coolant (antifreeze) and tap water for the engine coolant.

Supplement: New machines are delivered with JIS Type 2 long-life coolant (antifreeze) at a concentration of 50%.

Refer to page 110 "Lubricant and Fuel Chart".

Battery

As the temperature drops, the battery performance decreases.

Inspect the battery. If the charge is low, contact a Takeuchi sales or service outlet to have the battery charged.

Refer to page 131 "Inspecting the Battery Fluid Level and Replenishing".

Cautions after Completing Operations

Heed the following in order to prevent dirt, water, or other objects stuck on the machine as well as the lower body from freezing :

- Remove any dirt or water from the body.

In particular, water droplets on the hydraulic cylinder rod surfaces could freeze, and if dirt enters into the seals along with this, the seals could break.

- Park the machine on a dry, hard surface. If no appropriate place can be found, put boards down and park the machine on them.

- Drain any water from the fuel tank to prevent freezing.

Refer to page 132 "Draining the Fuel Tank".

- To prevent decreased battery performance, place a cover over the battery or remove it from the machine and store it in a warm place.

Also add battery fluid before starting the next morning. If battery fluid is added after completing operations, the distilled water may not mix, resulting in freezing.

After Cold Weather is Over

Perform the following after cold weather is over :

- Change the fuel and the oils for the different devices with those specified on the Lubricant and Fuel Chart.

Refer to page 110 "Lubricant and Fuel Chart".

- When using one-season type antifreeze coolant, completely drain the antifreeze coolant, carefully clean the inside of the coolant system, then add tap water.

Refer to page 138 "Cleaning the Engine Cooling System".



Rubber crawlers have an inherent weakness due to their use of rubber. Be sure to heed the prohibitions and cautions below so as to prevent damage to the crawlers and crawler slippage.

Prohibited Actions

Do not travel or operate the machine in the following places :

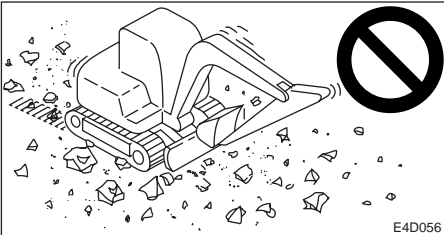

- Traveling or slewing on broken stone, jagged base rock, iron rods, iron scraps or the edges of iron sheets may damage or cut the crawlers.

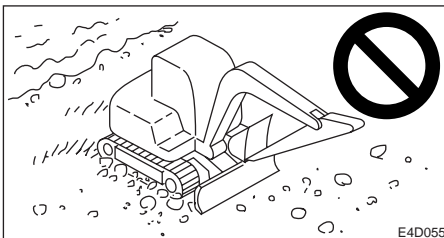

- Traveling on riverbeds or places with many soft rocks may cause the crawlers to slip off or be damaged due to rocks getting stuck in them.
- Do not use on the seashore. The salt may corrode the metal cores.

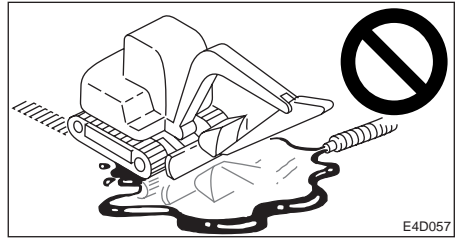

- Do not let fuel, oil, salt or chemical solvents get on the crawlers. These substances may corrode the couplings of the crawlers' metal cores, resulting in rust or peeling. If these substances should get on the crawlers, wipe them off immediately using water.

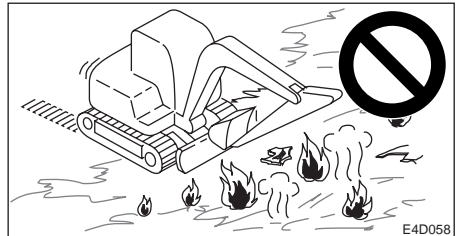

- Traveling on roads directly after asphaltting or on hot surfaces such as over fires or on iron sheets under strong sunlight may result in irregular wear or damage of the lugs.
- Do not move earth in places where the rubber crawlers may slip. Doing so may speed up lug wear.

**Cautions**

Heed the following cautions when operating the machine :

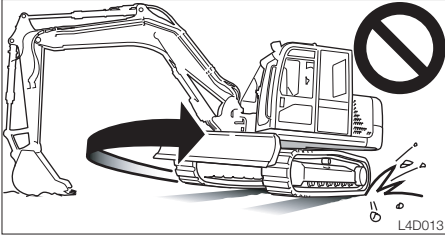

- Do not turn the undercarriage with the front of the machine body lifted using the hoe attachment and the upperstructure left in this posture. Doing so will twist the crawler with the load concentrated on a single point on the crawler belt, rapidly leading to damage.
- Avoid changing course abruptly and spinning on concrete surfaces whenever possible. Doing so may wear or damage the rubber crawlers.
- Avoid drops that may expose the rubber crawlers to strong shocks.
- Salt, potassium chloride, ammonium sulfate, potassium sulfate, and triple superphosphate of lime can damage the crawler belts. If any of these substances should get on the crawler belts, wash them off thoroughly with water.
- Do not let the sides of the rubber crawlers rub against concrete or walls.
- Do not damage the rubber crawlers by hitting the bucket against them.
- Be especially careful in the winter on snowy or frozen surfaces as the crawler belts tend to slip.
- Use rubber crawler belts at temperatures between -25°C to $+55^{\circ}\text{C}$ (-14°F to 131°F).

- When storing the rubber crawlers for long periods of time (3 months or more), do so indoors in a place not exposed to direct sunlight or rain.

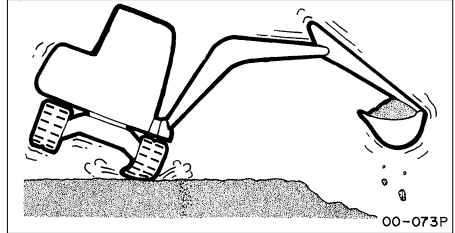

- Rubber crawler belts are not as stable as steel crawler belts since the entire lug is rubber. Be very careful when slewing and swinging sideways.

Preventing the Rubber Crawlers from Slipping Off

Heed the following in order to prevent the rubber crawlers from slipping off:

- Always keep the crawlers at the proper tension.

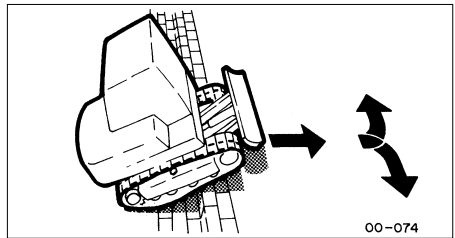

- When traveling up large cobblestone or rock steps (20 cm (8 in.) or greater), climb up the step at a direct angle and do not change course on top of the step.

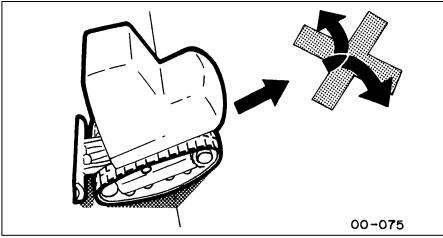

- When climbing in reverse, do not change course at the point where the slope starts.

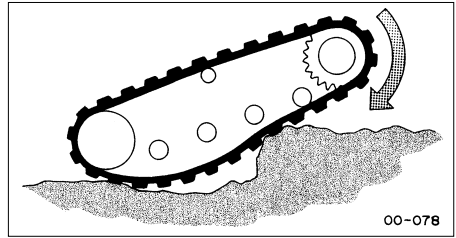
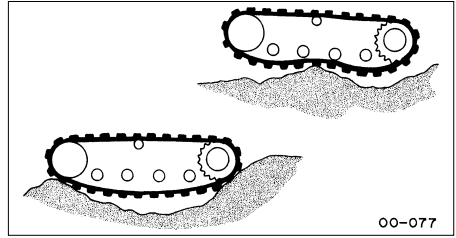

- Do not change directions when the crawler belts are slack as shown in the diagram.

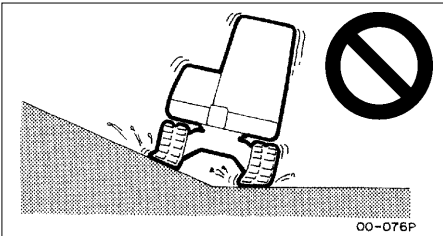

- Avoid traveling with one crawler on a slope or projecting object and the other crawler on a flat surface (with the machine at a tilt of 10° or greater). Travel with both crawlers on flat surfaces.



TRANSPORT

Loading and Unloading	102
Hoisting the Machine < TB153FR >	103
Hoisting the Machine < TB180FR >	104
Securing the Machine	105
Cautions on Transporting	105

**⚠ WARNING**

The machine may roll or tip over or fall while loading or unloading it. Take the following precautions :

- Select a firm, level surface and keep sufficient distance from road shoulders.
- Use loading ramps of adequate strength and size. Maintain the slope of loading ramps within 15 degrees.
- Keep the truck bed and loading ramps clean of oil, clay, ice, snow, and other materials which can become slippery. Clean the tracks.
- Never change course on the ramp.
- Do not slew (swing) on ramps. The machine may tip over.
- When slewing (swinging) on the truck bed, do so slowly as the footing can be unstable.

When loading or unloading the machine, be sure to use ramps and following the procedure below.

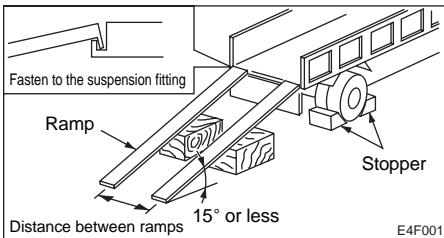

1. Apply the truck's parking brake and place stoppers against its tires.
2. Fasten the ramps securely to the truck bed so that they will not come off. Set the ramps to an angle of 15° or less.
3. Line up the center of the truck bed with the center of the machine and the center of the ramps with the center of the crawlers.
4. Make sure the dozer blade does not hit the ramps.
5. Lower the hoe attachment as much as possible, making sure it will not hit the truck.
6. Lower the engine speed.

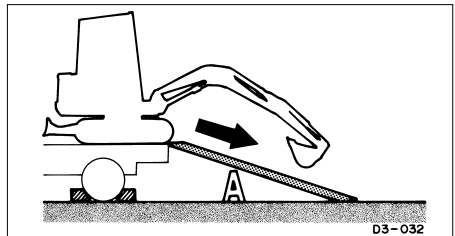
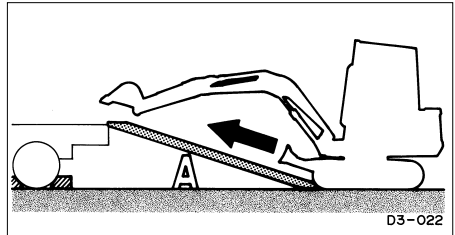

7. Determine the direction on the ramps, then slowly travel up or down the ramps in 1st speed (low speed), following the signals of a flagman.
8. Load the machine properly at the prescribed position on the bed. Refer to page 105 "Transporting Posture".

**⚠ WARNING**

- Know and use correct crane signals.
- Inspect the hoisting equipment daily for damaged or missing parts.
- When hoisting, use a wire rope with sufficient strength with respect to the machine's weight.
- Do not hoist with the machine in a posture other than the one described in the procedure below. Doing so is dangerous as it may result in the machine losing its balance.
- Do not hoist the machine with an operator (s) on it.
- When hoisting, hoist slowly so that the machine does not tip.
- Keep all other persons out of the area when hoisting. Do not move the machine over the heads of the persons.

IMPORTANT: This hoisting method applies to machines with standard specifications.

The center of gravity differs according to the attachments and options that are mounted.

Consult a Takeuchi sales or service outlet.

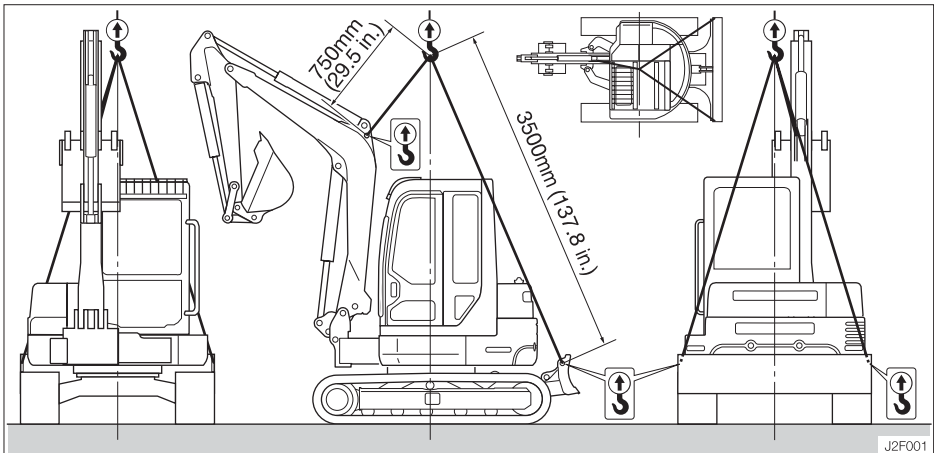
Hoisting posture**Hoisting**

1. Slew the upper structure so that the dozer blade is positioned to the rear of the body (so that the crawler frame and upper structure are parallel).
2. Raise the dozer blade fully.
3. Fully extend the bucket and arm cylinders and fully raise the boom.
4. If the boom is swung to either the left or right side, set it so that it is straight ahead.
5. Raise the safety lock lever to engage the lock.
6. Stop the engine and remove the starter key and get off the machine.
7. Install the sling as shown on the diagram below.
Suspend in such a way that the sling and Lifting tool do not touch the body.
8. Hoist slowly until the machine just leaves the ground.
9. Stop hoisting until the machine is stable and hoist slowly.

**⚠ WARNING**

- Know and use correct crane signals.
- Inspect the hoisting equipment daily for damaged or missing parts.
- When hoisting, use a wire rope with sufficient strength with respect to the machine's weight.
- Do not hoist with the machine in a posture other than the one described in the procedure below. Doing so is dangerous as it may result in the machine losing its balance.
- Do not hoist the machine with an operator (s) on it.
- When hoisting, hoist slowly so that the machine does not tip.
- Keep all other persons out of the area when hoisting. Do not move the machine over the heads of the persons.

IMPORTANT: This hoisting method applies to machines with standard specifications.

The center of gravity differs according to the attachments and options that are mounted.

Consult a Takeuchi sales or service outlet.

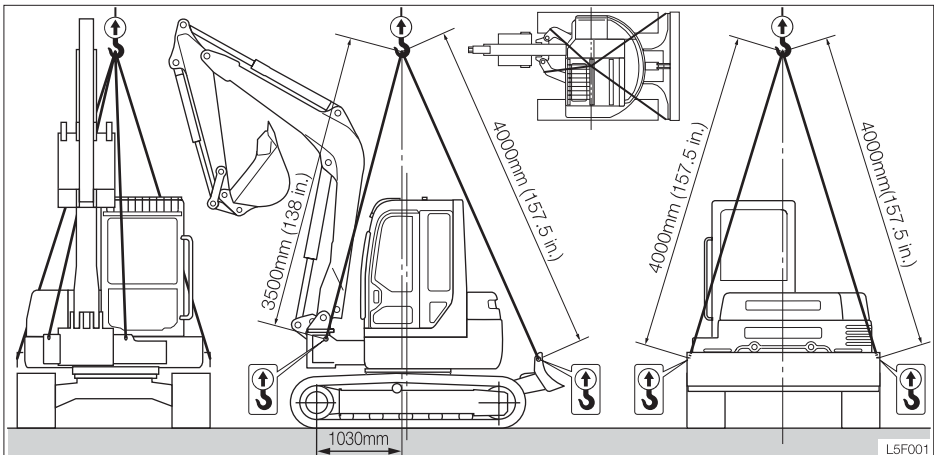
Hoisting posture**Hoisting**

1. Slew the upper structure so that the dozer blade is positioned to the rear of the body (so that the crawler frame and upper structure are parallel).
2. Raise the dozer blade fully.
3. Fully extend the bucket and arm cylinders and fully raise the boom.
4. If the boom is swung to either the left or right side, set it so that it is straight ahead.
5. Raise the safety lock lever to engage the lock.
6. Stop the engine and remove the starter key and get off the machine.
7. Install the sling as shown on the diagram below.
Suspend in such a way that the sling and Lifting tool do not touch the body.
8. Hoist slowly until the machine just leaves the ground.
9. Stop hoisting until the machine is stable and hoist slowly.



After loading the machine in the designated position, secure it as described below.

Transporting Posture

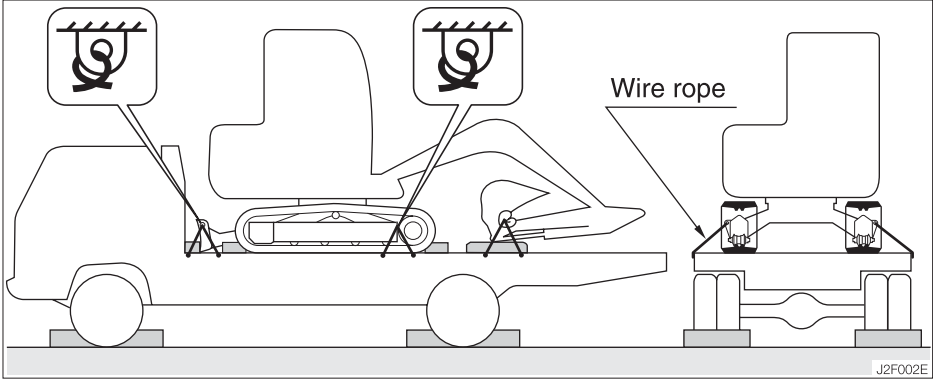

1. Lower the blade.
2. Fully extend the bucket and arm cylinders, then lower the boom.
3. Stop the engine and remove the starter key.
4. Raise the safety lock lever to engage the lock.
5. Set stoppers in front and behind the crawlers.
6. Put a chain or wire rope over the lower frame and fasten it securely to prevent sideways slippage.
7. Secure the bucket with a chain or wire rope.

IMPORTANT: Place a wooden block under the bucket so that it is not damaged by hitting the floor.

WARNING

- Know and follow the safety rules, vehicle code and traffic laws when transporting the machine.
- Consider the length, width, height and weight of the truck with the machine loaded on it when determining the best route.



MAINTENANCE

General	108
Service Data	110
Important Parts	115
Maintenance Chart	116
Walk-Around Inspection	118
Daily Inspection (Every 10 Hours).....	120
After First 50 Hours	
(New Machines Only).....	125
Every 50 Hours	128
After First 250 Hours	
(New Machines Only).....	133
Every 250 Hours	134
Every 500 Hours	137
Every 1000 Hours	138
Every 2000 Hours	142
When Required	145
Long-term Storage	160



Maintenance Description

For long-term use of the machine under good conditions, perform the inspection and maintenance procedures properly and safely as recommended in this manual.

The inspection and maintenance items are divided according to the machine's total operating time (inspection and maintenance to be performed every 10 hours (walk-around and daily inspection), every 50 hours, every 250 hours, etc.). Refer to the hour meter to determine when it is time to perform inspection and maintenance. Items for which it is not possible to determine the inspection and maintenance interval are included under "When Required".

When operating the machine in extremely harsh environments (with high dust levels or high temperatures), inspection and maintenance should be performed earlier than the times indicated on the Maintenance Chart.

Cautions on Maintenance

Do not perform inspection and maintenance procedures not prescribed in this manual. Have inspection and maintenance procedures not prescribed in this manual performed by a Takeuchi sales or service outlet.

Always keep the machine clean.

- Always keep the machine clean, and wash it before performing inspection and maintenance.
- When washing the machine with water, stop the engine and cover the electrical system with plastic to protect it from water. Exposing the electrical system to water is dangerous and could result in short-circuits or malfunction. Do not wash the battery, sensors, connectors or the inside of the cab with water or steam.

Fuel, lubricant and grease

- For fuels, lubricant and grease, follow the instructions on the "Lubricant and Fuel Chart".
- Use pure fuels, lubricants and greases which do not contain water, and be careful to keep dirt out when changing or replenishing fuel, lubricant or grease.
- Store fuels, lubricants and greases in the prescribed places and in such a way that no water or dirt can get in them.

Cautions on fueling

- If the port includes a strainer, do not remove the strainer when fueling.
- After fueling, be sure to securely tighten the cap, etc.
- Do not add more than the prescribed amount of fuel.

**Do not clean parts with fuel.**

Do not use fuel to clean parts. Use a non-combustible cleaning agent.

Keep dirt out.

When mounting and removing parts, do so in a place where there is no dust, clean the working area and the part, and keep dirt out.

Clean mounting surfaces.

When mounting and removing parts, be sure that the surfaces of contact of the parts are clean. If the sealing grooves of the surface of contact are damaged, consult a Takeuchi sales or service outlet.

Seals and split pins

- Replace removed seals and split pins with new ones.
- When mounting, be careful not to damage or twist the seal.

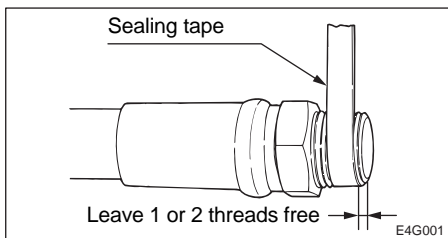
Sealing tape

- When wrapping sealing tape around plugs, etc., remove any old sealing tape from the threads and clean the threads.
- Wrap the sealing tape tight, leaving 1 or 2 threads at the tip free.

Disposing of wastes

- Collect spent fluids from the machine in containers. Disposing of wastes irresponsibly damages the environment.
- Dispose of oil, fuel, cooling water, coolant, filters, batteries and other harmful substances as prescribed by law.

Check after maintenance

- Gradually increase the engine speed from a low idle to maximum speed and check that there is no oil or water leaking from serviced parts.
- Operate all the operating levers and check that the machine is operating properly.

Cautions on handling of battery cables

- Disconnect the battery cables (+,-) before working on the electrical system or doing any welding.
Remove the negative (-) battery cable first. When reconnecting the battery, connect the negative (-) battery cable last.
- Do not disconnect the battery cables while the engine is running. Doing so could damage the electronic circuitry of the alternator and other parts.



Lubricant and Fuel Chart

Use different lubricants, greases and fuels according to the temperature, referring to the chart below.

- Change the lubricant earlier than as shown in the table if it is extremely dirty or its performance has deteriorated severely.
- Whenever possible, use the same brand of lubricant as before. If changing with a different brand, replace the entire quantity – do not mix different brands.

Lubricants and greases

Part	Type	Type by temperature										Replacement interval	Capacity ℓ (US. qt.)
		-22 -30	-4 -20	14 -10	32 0	50 10	68 20	86 30	104 40	°F	°C		
Engine oil pan	Diesel engine oil API - CD	SAE 5W-20										After first 50 hrs. Every 250 hrs.	Upper limit: <TB153FR> 7.4 (7.8) <TB180FR> 10.2 (10.8) Lower limit: <TB153FR> 4.0 (4.2) <TB180FR> 5.7 (6.0)
		SAE 10W-30											
		SAE 15W-40											
Hydraulic tank	Antiwear hydraulic oil	ISO VG32										Every 2000 hrs.	System: <TB153FR> 110 (29.1 US.gal.) <TB180FR> 120 (31.7 US.gal.) Tank: 68 (18.1 US.gal.)
		ISO VG46											
		ISO VG68											
Engine cooling system	Coolant (water + coolant) **	50% coolant mixture					30% coolant mixture					Every 1000 hrs.	<TB153FR> 8.4 (8.9) <TB180FR> 9.5 (10)
Travel reduction gear	Gear oil API-GL-4	SAE 90										After first 250 hrs.* Every 1000 hrs.	<TB153FR> 1.0 (1.06) <TB180FR> 1.5 (1.6)
Slew bearing	Lithium based grease EP-2 NLGI No. 2											Every 50 hrs.	As required
Working equipment												Daily or every 10 hrs.	
Levers												When required	

* : If the percentage of the traveling time within the total operating time is high, replace the gear oil earlier than the specified time.

** : For water, use tap water (soft). Do not use well or river water.

When the ambient temperature drops below 0°C, add coolant (antifreeze). Follow the coolant manufacturer's instructions to determine the mixture ratio.



Fuel

Part	Type	Capacity ℓ (US. gal.)
Fuel tank	Diesel fuel Use a clean, Quality fuel for good performance and optimum engine life. <ul style="list-style-type: none"> To prevent fuel flow problems in cold weather, use diesel fuel with a pour point of at least -12°C (10°F) below the lowest expected ambient temperature. Minimum cetane number is 45. Low temperature or high altitude operation may require the use of fuel with a higher cetane number. 	<TB153FR> 60 (15.9) <TB180FR> 92 (24.3)

Replace the hydraulic oil regularly!

When using a hydraulic breaker, the oil deteriorates quicker than during normal digging. Be sure to replace the hydraulic oil and return filter element.

- Failure to replace these in time can lead to damage to the machine and breaker's hydraulic systems. In order to improve the service life of the hydraulic systems, be sure to replace the hydraulic oil and return filter element according to the following chart of the replacement interval.
- Clean the suction strainer when changing the return filter element.

Replacement Interval (Hours)

Item	Hydraulic Oil	Filter Element
1st time	—	25
2nd time	—	100
Periodically	600	200

When the breaker operating ratio is 100% Refer to page 200 "Hydraulic Breaker".

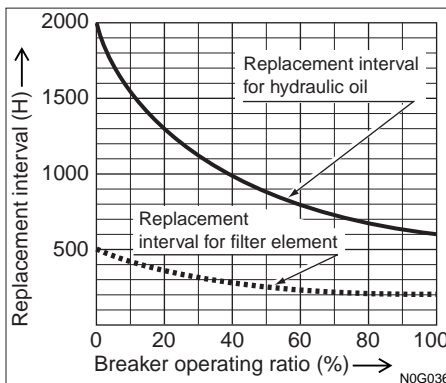

**Expendables**

Replace expendables such as filters and elements periodically, referring to the table below.

Item	Part name	Part No.	Replacement interval
Return filter	Element	15511-02600	After first 50 hrs. Every 500 hrs.
Fuel filter	Cartridge	119802-55800	Every 500 hrs.
Engine oil filter	Cartridge	<TB153FR> 129150-35152 <TB180FR> 129150-35151	After first 50 hrs. Every 250 hrs.
Air cleaner	Element (outer)	<TB153FR> 119808-12520 <TB180FR> 129062-12560	Every 1000 hrs. or after 6 cleanings (whichever comes first)
	Inner Element (option)	<TB153FR> 19111-02772 <TB180FR> 19111-07692	Every 1000 hrs. or after 3 cleanings of the outer element (whichever comes first)
Air breather filter	Element	15520-00902	Every 1000 hrs.



Tools

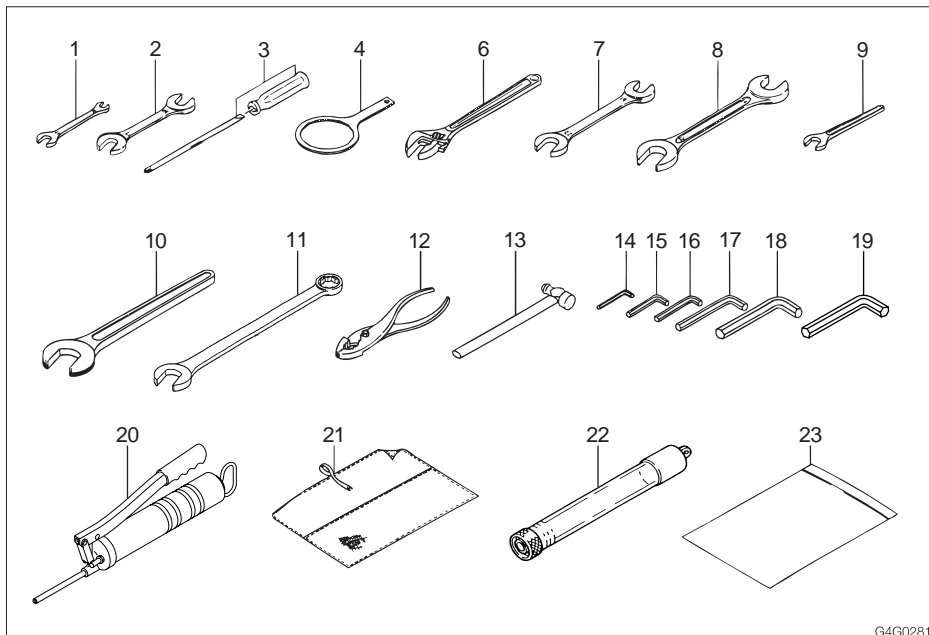

G4G0281

No.	Part name	Part No.	Remarks
1	Spanner	19100-47081	10-12
2	Spanner	19100-47082	14-17
3	Screwdriver	19100-06112	(+) (-)
4	Filter wrench	19100-65081	
6	Monkey wrench	16904-00250	250mm
7	Spanner	16900-01922	19-22
8	Spanner	16900-02427	24-27
9	Spanner	16901-00013	13
10	Spanner	16901-00041	41
11	Spanner	16909-00026	26
12	Pliers	16905-00200	200mm

No.	Part name	Part No.	Remarks
13	Hammer	16903-00330	3/4
14	Hex. wrench	16906-00400	4mm
15	Hex. wrench	16906-00500	5mm
16	Hex. wrench	16906-00600	6mm
17	Hex. wrench	16906-00800	8mm
18	Hex. wrench	16906-01000	10mm
19	Hex. wrench	16906-01400	14mm
20	Grease gun	16910-60610 16910-60600	TB153FR TB180FR
21	Tool case	16914-00001	
22	Drain connector for EU	15545-12601 15545-12600	TB153FR TB180FR
23	Case	16919-00001	



Tightening Torques

Nuts and Bolts (for ISO strength category 10.9)

Tighten nuts and bolts at the torques shown on the table below, unless otherwise specified in the text.

- Tightening torques when mounting plastic covers differ from the values on the table below. Consult a Takeuchi sales or service outlet. Tightening too strongly will break the cover.
- When replacing nuts and bolts, replace them with nuts and bolts of the same size and standards.
- Tighten nuts and bolts alternately (top, bottom, left then right) or in 2 or 3 times so that they are tightened uniformly.

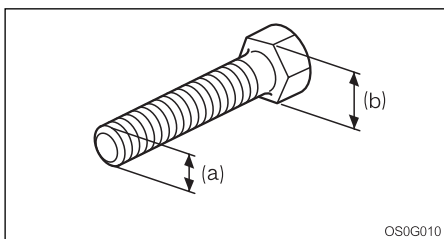
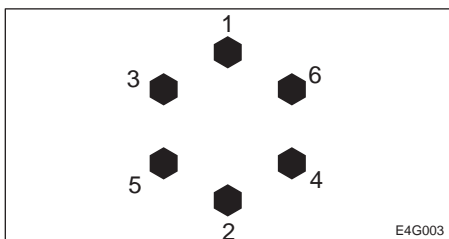

Thread	Head width (b) mm	Size (a) X Pitch mm	Torque	
			General Connection Points	
			N-m	ft-lb
Coarse	10	M6 X 1.0	9.8 ± 0.5	7.2 ± 0.4
	12, 13	M8 X 1.25	22.6 ± 1.1	16.6 ± 0.8
	14, 17	M10 X 1.5	47.1 ± 2.4	34.7 ± 1.7
	17, 19	M12 X 1.75	83.4 ± 4.1	61.5 ± 3.0
	19, 22	M14 X 2.0	134.4 ± 6.7	99.1 ± 4.9
	22, 24	M16 X 2.0	207.9 ± 10.4	153.3 ± 7.7
Fine	27, 30	M20 X 2.5	410.9 ± 20.5	303.1 ± 15.1
	12, 13	M8 X 1.0	24.5 ± 1.2	18.1 ± 0.9
	14, 17	M10 X 1.25	50 ± 2.5	36.9 ± 1.8
	17, 19	M12 X 1.5	87.3 ± 4.3	64.4 ± 3.2
	19, 22	M14 X 1.5	135.3 ± 6.8	99.8 ± 5.0
	22, 24	M16 X 1.5	220.6 ± 11	162.7 ± 8.1
	27, 30	M20 X 1.5	452.1 ± 22.6	333.4 ± 16.6



For safe use, the machine must be serviced periodically. To increase safety, periodically replace the parts listed in the following table of important parts.
Serious injury or a fire could result if they deteriorate or are damaged.

Table of Important Parts

Unit		Important parts to be replaced periodically	Replacement Interval
Fuel system		Fuel hoses	Every 2 years
		Packing in fuel filler cap	
Engine connection		Engine oil filter hoses	
Heater & AC systems		Heater hoses	
		Air conditioner hoses	
Hydraulic system	Machine body	Hydraulic hoses (Pump - delivery)	
		Hydraulic hoses (Pump - suction)	
		Hydraulic hoses (Slew motor)	
		Hydraulic hoses (Travel motor)	
	Working equipment	Hydraulic hoses (Boom cylinder lines)	
		Hydraulic hoses (Arm cylinder lines)	
		Hydraulic hoses (Bucket cylinder lines)	
		Hydraulic hoses (Offset cylinder)	
		Hydraulic hoses (Blade cylinder)	
		Hydraulic hoses (Pilot valve)	
		Hydraulic hoses (Auxiliary lines)	
		Seat belt	Every 3 years

Above important parts are vulnerable to aging and wear or deterioration and it is difficult to determine the degree to which they have deteriorated on the occasion of periodic service. To maintain their proper function at all times, therefore, replace them with new ones after using them for a specific period of time even if no abnormality is found with the parts. If you find abnormalities in these parts before their scheduled replacement time is reached, repair or replace them immediately. If a hose clamp is deformed or cracked, replace it immediately. When replacing the important parts, please contact a Takeuchi sales or service outlet .

Also check the hydraulic hoses other than the above important parts. If any abnormality is found in them, retighten them or replace them immediately.

When replacing the hydraulic hoses, replace the O-rings and seals at the same time.

Check the fuel and hydraulic hoses according to the periodic schedule described below. Refer to "Maintenance".

Type of inspection	Inspection item
Daily inspection	Leakages from joints, hydraulic or fuel hoses.
Monthly inspection	Leakages from joints, hydraulic or fuel hoses.
	Damaged hydraulic or fuel hoses (cracks, wear and tear).
Annual inspection	Leakages from joints, hydraulic or fuel hoses.
	Deteriorated, twisted, damaged hydraulic or fuel hoses (cracks, wear and tear) or hoses in contact with other parts of the machine.



Maintenance Items	See page
Walk-Around Inspection	
Inspecting by opening the engine hood and covers	118
Inspecting by walking around the machine	119
Inspecting while sitting in the operator's seat	119
Daily Inspection (Every 10 Hours)	
Inspecting and replenishing the coolant	120
Inspecting and replenishing the engine oil	121
Inspecting the water separator	121
Inspecting the fuel level	122
Inspecting the hydraulic oil level and replenishing	122
Lubricating the working equipment	124
After First 50 Hours (New Machines Only)	
Replacing the hydraulic oil return filter	125
Replacing the engine oil and oil filter	126
Inspecting and adjusting the fan belt	127
Every 50 Hours	
Inspecting and adjusting the crawler tension	128
Lubricating the slew bearing	130
Inspecting the battery fluid level and replenishing	131
Draining the fuel tank	132
After First 250 Hours (New Machines Only)	
Replacing the travel motor gear oil*	133
Every 250 Hours	
Replacing the engine oil and oil filter	134
Inspecting and adjusting the fan belt	134
Cleaning the air cleaner	134
Cleaning the radiator fins and oil cooler fins	136

* If the percentage of the traveling time within the total operating time is high, replace the gear oil earlier than the specified time.



Maintenance Items	See page
Every 500 Hours	
Replacing the hydraulic oil return filter	137
Replacing the fuel filter	137
Every 1000 Hours	
Cleaning the engine cooling system	138
Replacing the air cleaner element	140
Replacing the air breather filter	141
Replacing the travel motor gear oil	141
Inspecting and adjusting the engine valve clearance	141
Retightening the engine cylinder head bolts	141
Inspecting the engine fuel injection pressure and spray condition	141
Every 2000 Hours	
Replacing the hydraulic oil and cleaning the suction strainer	142
Inspecting the engine fuel injection timing	144
Inspecting the engine fuel injection valve	144
When Required	
Inspecting and replenishing the windshield washer fluid	145
Cleaning the water separator	145
Lubricating the levers	146
Adjusting the gap between the bucket and arm < TB180FR >	147
Replacing the bucket	148
Replacing the bucket teeth and the side cutters < TB153FR >	150
Replacing the bucket teeth and the side cutters < TB180FR >	152
Tilting up the platform	154
Inspecting the rubber crawlers	155
Replacing the rubber crawlers < TB153FR >	156
Replacing the rubber crawlers < TB180FR >	158



Perform the following inspections once every day before starting the engine the first time.

⚠ WARNING

- **Before operating, perform the walk-around inspections and make repairs immediately should any irregularities be found.**
- **Be sure to secure the engine hood or cover when opening it. Do not open the engine hood or cover on slopes or in strong wind.**

Before starting the engine, look around the machine and lower body, clean any combustible materials off high temperature parts of the engine, and inspect for such irregularities as oil leakage, water leakage and looseness of nuts and bolts.

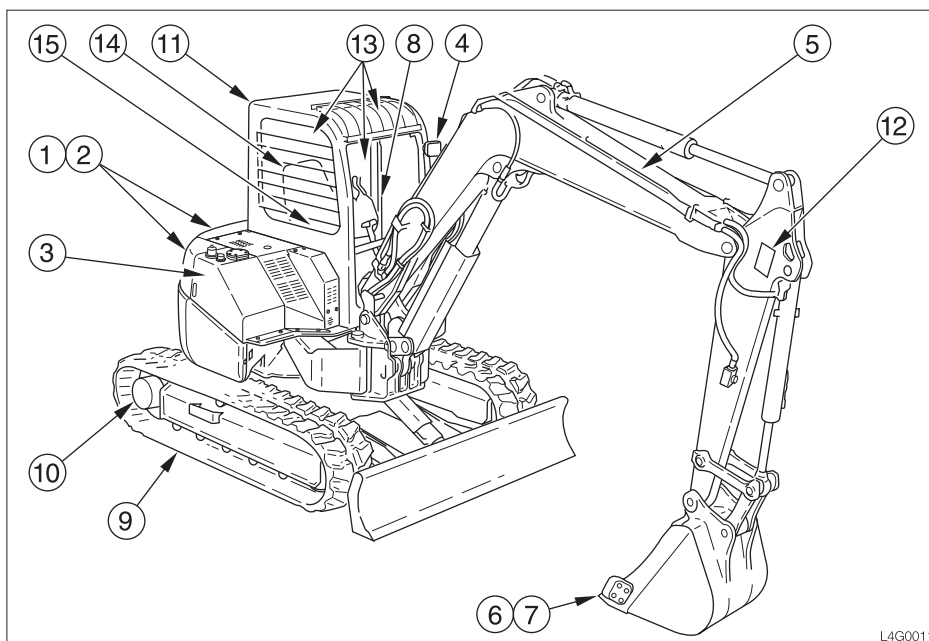

L4G0011

Inspecting by Opening the Engine Hood and Covers

1. Check for any twigs, leaves, oil or other combustible materials around the engine and battery.
2. Check for oil or engine coolant water leakage around the engine.
3. Check for oil leakage from the hydraulic tank, hydraulic devices, hoses and connections.



Inspecting by Walking Around the Machine

4. Check lights for dirt, damage and burnt out bulbs.
5. Check attachments and hoses for damage.
6. Check the bucket, bucket teeth and side cutter for wear, damage and looseness.
7. Check the hook, slip stopper and hook mount of buckets with hooks for damage. (Option)
8. Check the handrail and step for damage and loose bolts.
9. Check the crawler, carrier roller, track roller, idler and sprocket for damage, wear and loose bolts.
10. Check for oil leakage from the travel motor.
11. Check the canopy, cab and guard for damage and loose nuts and bolts.
Check the rear view mirror and room mirror for dirt, damage, and angle adjustment.
12. Check the labels for dirt and damage.

Inspecting While Sitting in the Operator's Seat

13. Check the windshield for dirt or damage.
14. Check the seat and seat belt for dirt or damage.
Check the operator's seat for dirt, oil or other combustible materials.
15. Check the monitor, instruments and switches for dirt or damage.



Perform the following inspections once every day before starting the engine the first time.

⚠ WARNING

- Before operating, perform the Daily inspections and make repairs immediately should any irregularities be found.
- Be sure to secure the engine hood or cover when opening it. Do not open the engine hood or cover on slopes or in strong wind.

Inspecting and Replenishing the Coolant

⚠ WARNING

Do not remove the radiator cap or drain plugs when the coolant is hot. Stop the engine, let the engine and radiator cool and loosen the radiator cap or drain plugs slowly.

Inspection

< TB153FR >

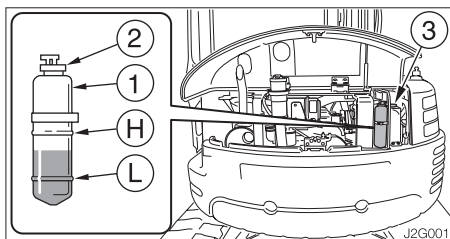

< TB180FR >

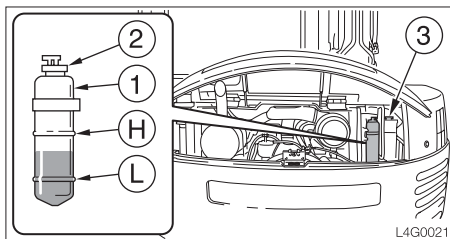

1. Open the engine hood.

2. Inspect the quantity of coolant in the reserve tank (1).

The level should be between the upper limit (H) and lower limit (L).

If it is below the lower limit (L), replenish.

Replenishing

1. Remove the reserve tank's cap (2).
2. Add coolant up to the upper limit (H) of the reserve tank (1).
If the reserve tank is empty, inspect for fluid leakage, then inspect the radiator coolant level. If it is low, add water to the radiator first, then to the reserve tank.
3. Install the cap (2).



Inspecting and Replenishing the Engine Oil

⚠ WARNING

Stop the engine and allow the machine to cool down before performing inspection and maintenance.

Inspection

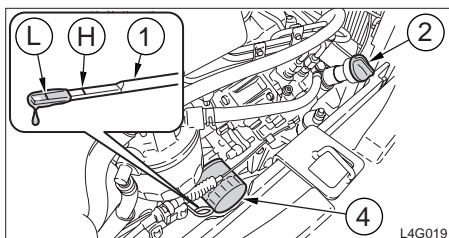

1. Open the engine hood.
2. Pull out the dipstick (1) and wipe off the oil with a rag.
3. Fully reinsert the dipstick (1), then pull it back out.
4. Check the oil on the dipstick (1).
The level should be between the upper limit (H) and lower limit (L).
If it is below the lower limit (L), replenish.

Replenishing

1. Remove the oil supply cap (2).
2. Add oil up to the upper limit (H) of the dipstick (1).
Problems could arise if the oil level is either too low or too high.
3. Tighten the oil supply cap (2).
4. Start the engine, run it at low idle for about 3 minutes, then stop it.
5. After about 10 minutes, inspect the oil level.

Inspecting the Water Separator

⚠ WARNING

Stop the engine and allow the machine to cool down before performing inspection and maintenance.

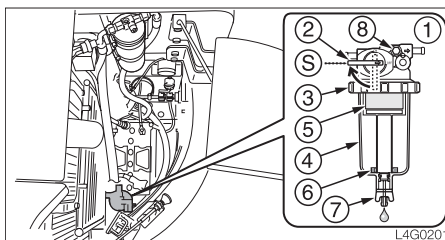

Ⓢ : Closed

1. Open the rear cover.
2. Inspect the water separator (1).
If the red indicator ring (6) is sunk to the bottom of the case (4), no water is mixed in.
If the red indicator ring (6) is floating, there is water up to the bottom of the ring. Drain the water and clean.
3. Place a pan under the drain valve (7).
4. Open the drain valve (7) and drain the water.
If the water does not drain easily, loosen the plug (8).
5. Close the drain valve (7) and plug (8).
Refer to page 145 "Cleaning the Water Separator".

Bleeding the air from the fuel system

Refer to page 168 "Bleeding the Air from the Fuel System".

Supplement: Air in the fuel system can make it difficult to start the engine and cause engine problems. Also bleed the air when the fuel tank is emptied.



Inspecting the Fuel Level

WARNING

- Do not smoke or permit open flames while fueling or near fueling operations.
- Stop the engine in a well-ventilated place when adding fuel.
- Clean up spilled fuel immediately.
- Do not fill the fuel tank to capacity. Allow room for expansion.
- Tighten the fuel filler cap securely.

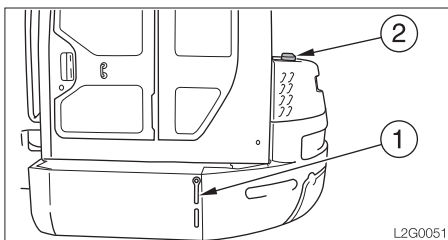

1. Check the fuel level at the sight gauge (1).
2. If the level is low, add fuel from the fuel port (2) while watching the sight gauge (1). Refer to page 42 "Fuel Filler Cap".

Inspecting the Hydraulic Oil Level and Replenishing

WARNING

Oil may spurt out if caps or filters are removed or pipes disconnected before releasing the pressure in the hydraulic system.

- Gradually press the air breather button to relieve tank pressure.

Inspection

The oil level changes according to the oil temperature. Inspect the oil level in the hydraulic oil level inspection posture shown in the diagram.

- Hydraulic oil level inspection posture

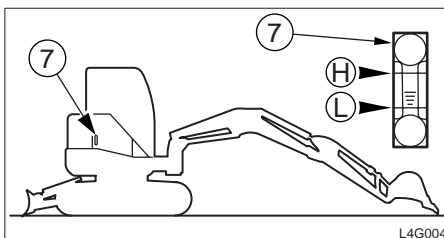

1. Start the engine and run it at low speed.
2. Fully offset the boom to the left.
3. Fully retract the arm and bucket cylinders and ground the bucket.
4. Ground the dozer blade, then stop the engine.
5. Inspect the oil level at the sight gauge (7). When the oil temperature is about 20°C (68°F):
 - The level should be halfway between the upper limit (H) and lower limit (L). If it is below the lower limit (L), replenish.
 - When the oil temperature is about 50 to 80°C (122 to 176°F):
 - The level should be near the upper limit (H).



Replenishing

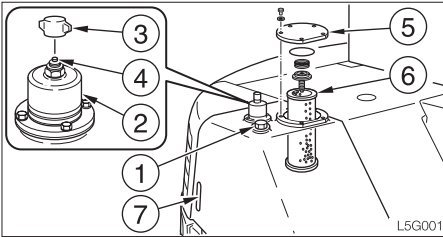

1. Remove cap nut (3) on the air breather (2).
2. Press button (4) and bleed the air from the tank.
3. Tighten securely by hand with cap nut (3).
4. Remove the plug (1).
5. Add hydraulic oil up to the middle of the sight gauge (7).
6. Tighten the plug (1).



Lubricating the Working Equipment

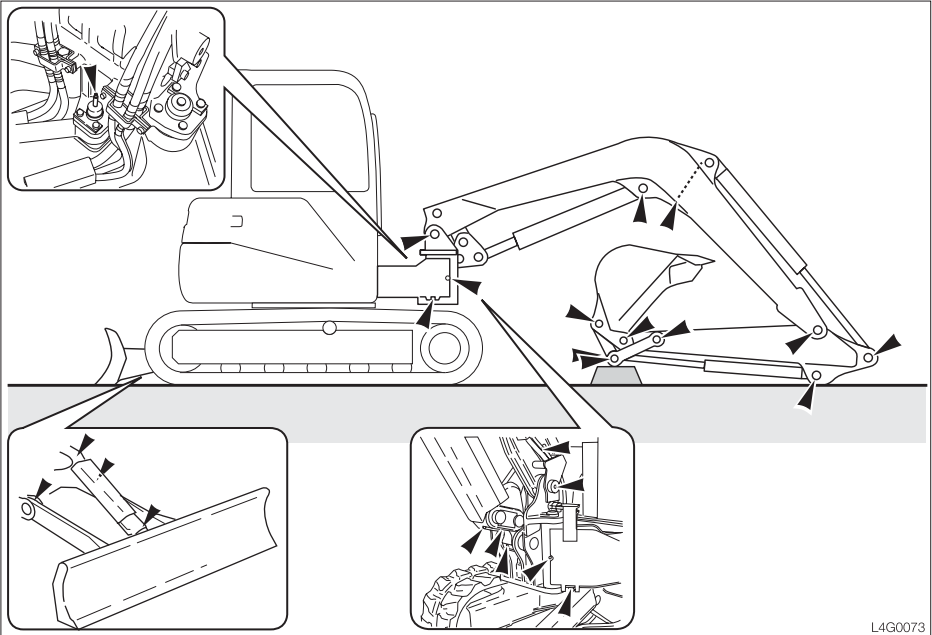

L4G0073

1. Set the machine to the lubrication posture shown in the diagram above, ground the working equipment, then stop the engine.
2. Use the grease gun to lubricate the grease nipples.
3. Wipe off the expelled grease.



Replacing the Hydraulic Oil Return Filter

WARNING

- Stop the engine and allow the machine to cool down before performing maintenance.
- The engine, hydraulic lines and many other parts of the machine are hot directly after the engine is stopped. Touching these parts will cause burns.
- The hydraulic fluid is also hot and under high pressure. Be careful when loosening caps and plugs. Working on the machine under these conditions could result in burns or injuries due to the hot oil spurting out.
- Oil may spurt out if caps or filters are removed or pipes disconnected before releasing the pressure in the hydraulic system.
- Gradually press the air breather button to relieve tank pressure.
- When removing plugs or screws or disconnecting hoses, stand to the side and loosen slowly to gradually release the internal pressure before removing.

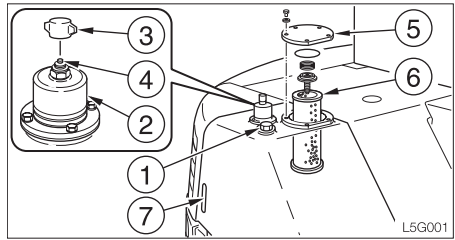

1. Remove cap nut (3) on the air breather (2).
2. Press button (4) and bleed the air from the tank.
3. Tighten securely by hand with cap nut (3).
4. Loosen the bolts, and remove the flange (5).
5. Remove the return filter (6).
6. Install the new return filter.
7. Install the flange (5).
8. Inspect the level with the sight gauge (7), and replenish if the level is low. Refer to page 122 "Inspecting the Hydraulic Oil Level and Replenishing".



Replacing the Engine Oil and Oil Filter

⚠ WARNING

Stop the engine and allow the machine to cool down before performing maintenance.

- The engine, muffler, radiator and many other parts of the machine are hot directly after the engine is stopped. Touching these parts will cause burns.
- The engine oil is also hot. Be careful when loosening caps and plugs. Working on the machine under these conditions could result in burns.

IMPORTANT: Check the spent oil. If it contains large amounts of metal powder, consult a Takeuchi sales or service outlet.

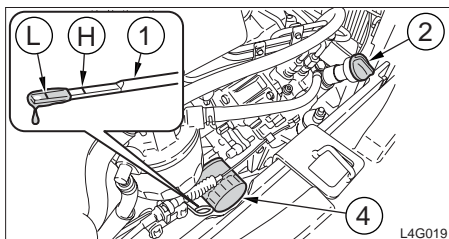

1. Open the engine hood and remove the oil supply cap (2).

< TB153FR >

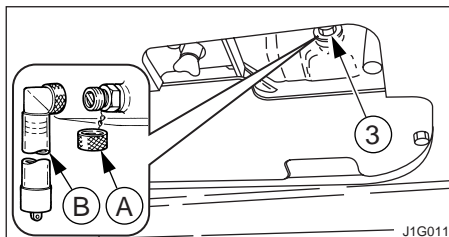

< TB180FR >

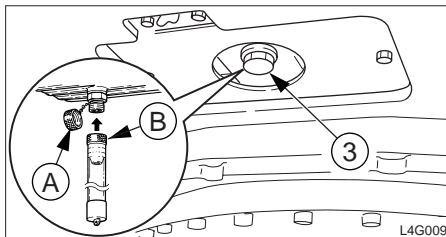

2. Place a pan for catching the spent oil under the drain plug (3).
3. Remove cap (A), install connector (B) and drain the oil. (The oil comes out when the screw is tightened.)
4. Remove connector (B) and install cap (A).
5. Using a filter wrench, turn the filter (4) counterclockwise and remove it.
6. Clean the filter installation surface on the filter stand.
7. Apply a thin layer of oil to the packing of the new filter.
8. Install the new filter by hand.
9. Tighten 3/4 more turns with the filter wrench after the filter packing comes in contact with the surface of installation.
 - Tightening torque : 20 to 24 N-m (14.5 to 17.4 ft-lb)
10. Remove the oil supply cap (2).
11. Add oil up to the upper limit (H) of the dipstick (1). Problems could arise if the oil level is either too low or too high.
12. Tighten the oil supply cap (2).
13. Start the engine, run it at low idle for about 3 minutes, then stop it.
14. After about 10 minutes, inspect the oil level.



Inspecting and Adjusting the Fan Belt

WARNING

Stop the engine and allow the machine to cool down before performing inspection and maintenance.

- The engine, muffler, radiator, hydraulic lines, sliding parts and many other parts of the machine are hot directly after the engine is stopped. Touching these parts will cause burns.

Inspection

1. Open the engine hood.

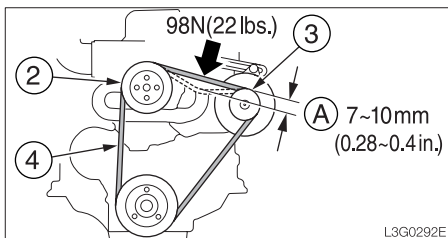

2. Press the fan belt at midway between the fan pulley (2) and alternator pulley (3) and check the tension (about 98 N or 22 lbs.). The slack (A) should be about 7 to 10 mm (0.28 to 0.4 in.).
3. Inspect the fan belt (4) and replace it if:
 - there are cuts or cracks.
 - the belt is worn and touches the bottom of the V groove in the pulley.
 - the belt stretches and cannot be adjusted.

Adjustment

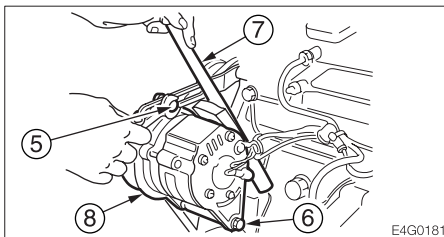

1. Tilt up the platform.
Refer to page 154 “Tilting Up the Platform”.
2. Loosen the adjusting bolt (5) and locking nut (6).
3. Using a lever (7), move the alternator (8) and adjust the slack.
4. Tighten the adjusting bolt (5) and locking nut (6).



Inspecting and Adjusting the Crawler Tension

⚠ WARNING

- If you must work beneath the raised machine or equipment, always use wood blocks, jack-stands or other rigid and stable supports. Never get under the machine or working equipment if they are not sufficiently supported. This procedure is especially important when working on hydraulic cylinders.
- < TB153FR > : The track adjuster contains highly pressurized grease. If the tension is adjusted without following the prescribed procedure, the grease discharge valve may fly off, resulting in injury.
 - Do not loosen the grease nipple.
 - Loosen the grease discharge valve slowly.
 - Do not put your face, arms, legs or body in front of the grease discharge valve.
 - If no grease is expelled when grease discharge valve is loosened, there is a problem. Contact your nearest service outlet for repairs. DO NOT disassemble, as this is very dangerous.

Inspection

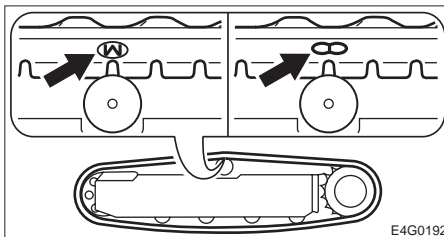

1. For rubber crawlers, move the machine so that the "M" or "∞" mark at the coupling is at the top center of the crawler frame.

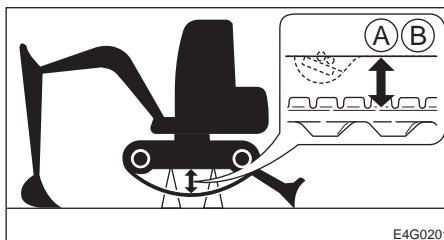

2. Use the operating devices to lift the body. Operate the levers slowly.

< TB153FR >

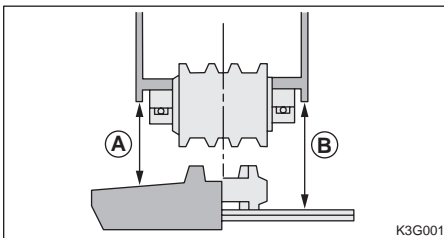



< TB180FR >

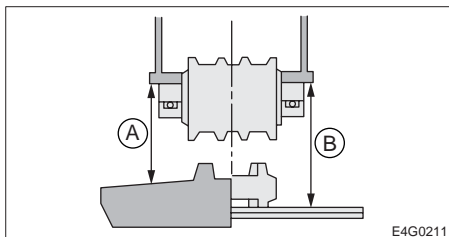

3. Inspect the gap (A or B) between the bottom surface of the frame at the center of the crawler frame and the top surface of the crawler.

The gap (A or B) should be within the following range :

< TB153FR >

(A) Rubber crawler :

108 to 118 mm (4.3 to 4.7 in.)

(B) Steel crawler :

172 to 192 mm (6.8 to 7.6 in.)

< TB180FR >

(A) Rubber crawler :

160 to 180 mm (6.3 to 7.1 in.)

(B) Steel crawler :

260 to 280 mm (10.2 to 11.0 in.)

Adjustment < TB180FR >

TB180FR uses a hydraulic cylinder to adjust the tension of the crawler belts. Note that it is not necessary to regularly perform adjustments of the tension of the belt itself.

Adjustment < TB153FR >

Increasing the tension

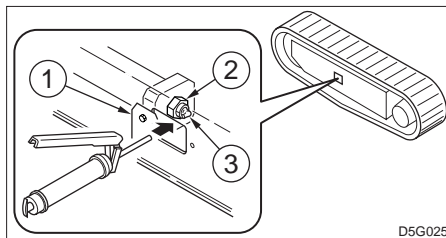

1. Remove the cover (1).
2. Using the grease gun, insert grease through the grease nipple (3) in the grease discharge valve (2).
3. Inspect the crawler tension.

Decreasing the tension

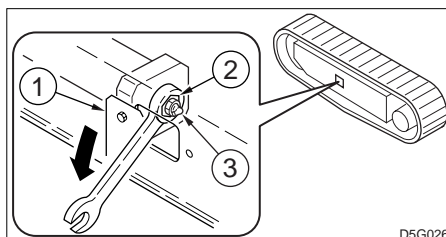

1. Remove the cover (1).
2. Using the Spanner, slowly loosen the grease discharge valve (2) and drain the grease.
If the grease does not drain easily, move the machine forward or backward.
3. Tighten the grease discharge valve (2).
 - Tightening torque : 177 N·m (130 ft.lb.)



Lubricating the Slew Bearing

WARNING

Do not slew while lubricating. Doing so is dangerous, as you may get caught in the machine.

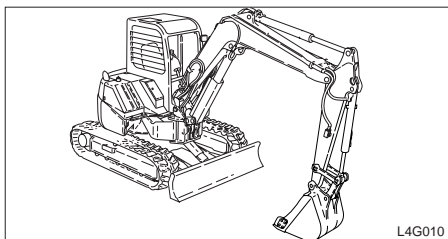

1. Stop the engine with the machine in the posture shown on the diagram above.

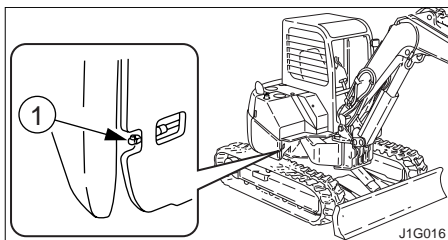

2. Use the grease gun to supply grease to the grease nipple (1).

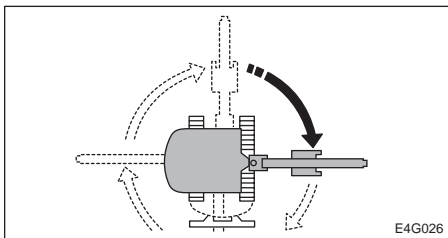

3. Start the engine, lift the bucket and slew clockwise 90°.
4. Ground the bucket and stop the engine.

5. Repeat steps 2 to 4 above three times.
6. Wipe off the grease expelled from the slew bearing and grease nipple.



Inspecting the Battery Fluid Level and Replenishing

⚠ DANGER

- Do not use the battery when the fluid level is below the lower level. Doing so will hasten the deterioration of the internal portions of the battery and shorten the battery life, and can also cause rupturing (or an explosion).
- Batteries generate flammable and explosive gases. Keep arcs, sparks, flames and lighted tobacco away.
- Use a dampened cloth to clean the area of the fluid level lines and check the fluid level. Note that if this area is cleaned with a dry cloth, static electricity could cause ignition or explosion.

⚠ WARNING

- Do not fill the battery above the upper level. Doing so could cause the fluid to leak, contact and damage the skin, or cause parts to corrode.
- Batteries contain sulfuric acid which will damage eyes or skin on contact.
 - If acid contacts eyes, flush immediately with clean water and get prompt medical attention.
 - If acid is accidentally swallowed, drink large quantities of water or milk and call a physician immediately.
 - If acid contacts skin or clothing, wash off immediately with clean water.

Inspection

IMPORTANT: Check the fluid level of all cells, even when the fluid level can be checked by indicator.

1. Open the rear cover.

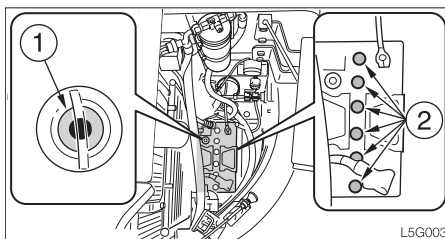

2. Inspect the indicator (1).
 - Blue : Good
 - White : Charging needed
 - Red : Insufficient battery fluid
3. Inspect the fluid level.

The fluid level should be between the lines indicating the upper level (H) and lower level (L). If not, add distilled water up to line (H).

 - If the fluid level can not be checked by fluid level lines.

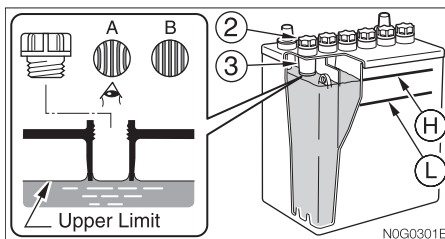

Remove the caps (2) and look into the fluid supply holes to check the fluid level. If the fluid is below the sleeve (3), be sure to add distilled water up to the bottom edge of the sleeve (3).

Proper amount (A)

The fluid reaches up to the bottom edge of the sleeve (3), so the surface tension causes the fluid to swell and the plate appears distorted.

Level too low (B)

The fluid does not reach up to the bottom edge of the sleeve (3), so the plate appears laminar, not distorted.

4. Also check the terminals for looseness and dirt.



Replenishing

When adding distilled water, do so before starting operations in order to prevent freezing.

1. Remove the caps (2), and add distilled water until the upper level (H).
2. Inspect the indicator (1) then it turns blue.
3. Clean the cap's exhaust hole, then tighten the caps (2) securely.

Draining the Fuel Tank

WARNING

- Do not smoke or permit open flames while handling fuel or working on the fuel system.
- Stop the engine in a well-ventilated place and allow it to cool down before performing maintenance.
- Clean up spilled fuel immediately.

Do this before operating the machine.

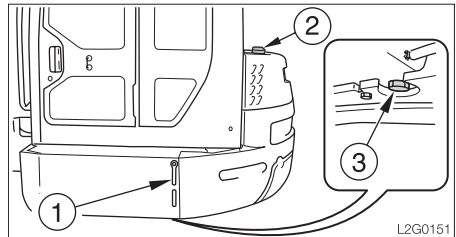

1. Remove the fuel filler cap (2).
2. Place a pan under the drain plug (3).
3. Open the drain plug (3) and drain the water and sediment from the bottom of the tank.
4. Close the drain plug (3).
5. While watching the sight gauge (1), add fuel.
6. Tighten the fuel filler cap (2) and lock it with the key.
7. Bleed the air.

Bleeding the air from the fuel system

Refer to page 168 "Bleeding the Air from the Fuel System".

Supplement: Air in the fuel system can make it difficult to start the engine and cause engine problems. Also bleed the air when the fuel tank is emptied.



Replacing the Travel Motor Gear Oil

WARNING

- Stop the engine and allow the machine to cool down before performing maintenance.
- The travel motors are hot directly after the engine is stopped. Touching them will cause burns.
- The gear oil is also hot and under high pressure. Be careful when loosening plugs. Working on the machine under these conditions could result in burns or injuries.
- The pressure in the travel motor reduction gears case may cause oil or the plug to fly out. Loosen the plug slowly to release the pressure.

IMPORTANT: If the percentage of the traveling time within the total operating time is high, replace the gear oil earlier than the specified time.

< TB153FR >

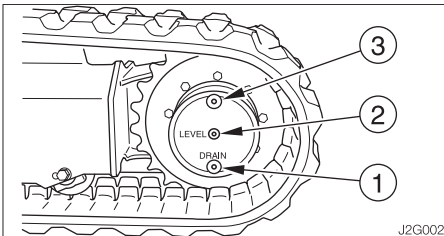

< TB180FR >

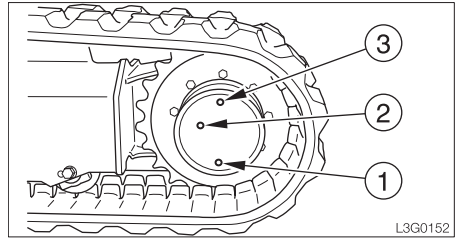

1. Set the travel motor so that plug (1) is at the very bottom.
2. Place a pan for catching the spent oil under plug (1).
3. Remove plugs (1), (2) and (3) and drain the oil.
4. Wrap new sealing tape around the plugs.
5. Tighten plug (1).
6. Add oil through the hole for plug (3) until oil flows out of the hole of plug (2).
7. Tighten plugs (2) and (3).



Replacing the Engine Oil and Oil Filter

Refer to page 126 “Replacing the Engine Oil and Oil Filter”.

Inspecting and Adjusting the Fan Belt

Refer to page 127 “Inspecting and Adjusting the Fan Belt”.

Cleaning the Air Cleaner

WARNING

- Stop the engine and allow the machine to cool down before performing maintenance.
- The engine, muffler, radiator and many other parts of the machine are hot directly after the engine is stopped. Touching these parts will cause burns.
- Wear required appropriate equipment such as safety glasses and filter mask when using compressed air, as metal fragments or other objects can fly and cause serious personal injury.

IMPORTANT: Be careful not to scratch the element. Do not use an element if it is damaged.

IMPORTANT: When operating the machine in very dusty places, inspection and maintenance should be performed every day.

Supplement: Do not remove and clean the inner element (option). Replace the inner element every 1000 hrs. or after every 3 cleaning of the outer element. (whichever comes first)

1. Open the engine hood.

< TB153FR >

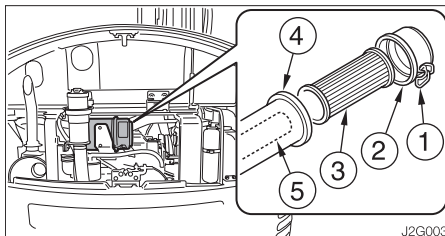

< TB180FR >

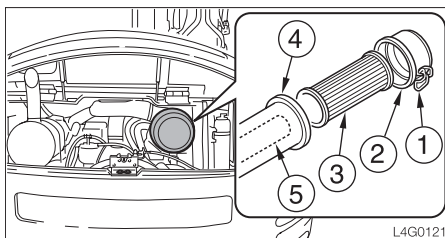

2. Loosen the clamp (1) and remove the dust cup (2).
3. Clean the inside of the dust cup (2).
4. Remove the element (3).
5. Cover the intake hole at the back of the body (4) with cloth or tape to prevent dirt from getting in.
< If equipped with the inner element >
To prevent dirt from getting inside the engine, do not remove the inner element (5).
6. Clean the inside of the body (4).

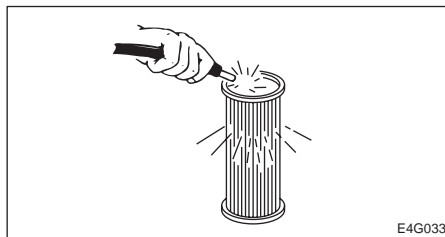



7. Clean the element (3) with dried compressed air {294 to 490 kPa (43 to 71 psi)}.

First blow the air from the inside of the element along the flutes, then blow the air from the outside, and finally from the inside again.

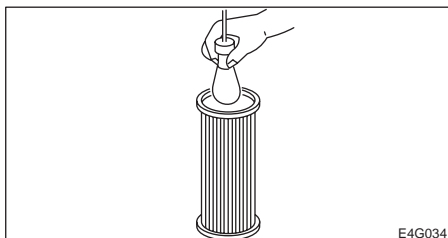

8. Light up the inside of the element (3) with a bulb, inspect it, and replace it if there are small holes or thin spots.
9. Remove the cloth or tape applied in step 5.
10. Install the element (3).
11. Install the dust cup (2) with the “TOP” mark at the top, then fasten it with the clamp (1).



Cleaning the Radiator Fins and Oil Cooler Fins

WARNING

Wear required appropriate equipment such as safety glasses and filter mask when using compressed air, as metal fragments or other objects can fly and cause serious personal injury.

IMPORTANT: Be careful not to damage the radiator fins and oil cooler fins when cleaning them.

- When using compressed air or pressurized water, make sure the pressure is no higher than 200 kPa (28 psi) and hold the nozzle sufficiently away from the fins.

IMPORTANT: When using water, cover the electrical system to prevent water from getting in.

IMPORTANT: When operating the machine in very dusty places, inspection and maintenance should be performed every day.

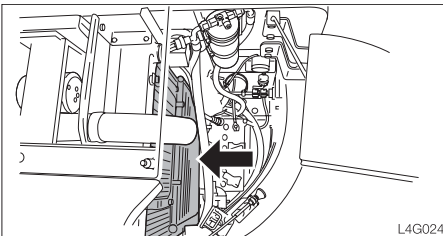

1. Open the rear cover.
2. Blow compressed air on the radiator fins and oil cooler fins to remove mud and dirt stuck on them.



Replacing the Hydraulic Oil Return Filter

Refer to page 125 “Replacing the Hydraulic Oil Return Filter”.

Replacing the Fuel Filter

WARNING

- Do not smoke or permit open flames while handling fuel or working on the fuel system.
- Stop the engine in a well-ventilated place and allow it to cool down before performing maintenance.
- Clean up spilled fuel immediately.

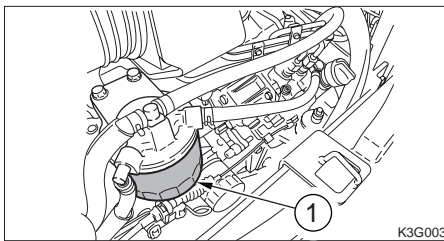

1. Open the engine hood.
2. Using a filter wrench, turn the filter (1) counterclockwise and remove it.
3. Clean the filter installation surface on the filter stand.
4. Apply a thin layer of oil to the packing of the new filter.
5. Install the new filter by hand.
6. Tighten 2/3 more turns with the filter wrench after the filter packing comes in contact with the surface of installation.
 - Tightening torque : 20 to 24 N·m (14.5 to 17.4 ft·lb)
7. Bleed the air.

Refer to page 168 “Bleeding the Air from the Fuel System”.



Cleaning the Engine Cooling System

⚠ WARNING

- Stop the engine and allow the machine to cool down before performing maintenance.
- The engine, muffler, radiator and many other parts of the machine are hot directly after the engine is stopped. Touching these parts will cause burns.
- The engine coolant is also hot and under high pressure. Be careful when loosening caps and plugs. Working on the machine under these conditions could result in burns or injuries due to the hot coolant spurting out.
- If maintenance must be performed with the engine running, always work as a two person team with one person sitting in the operator's seat while the other works on the machine.
- When performing maintenance, be sure to keep your body and clothing away from moving parts.
- Standing at the back of the machine while the engine is running is extremely dangerous, as the machine could move suddenly. Never stand at the back of the machine while the engine is running.
- Do not remove the radiator cap or drain plugs when the coolant is hot. Stop the engine, let the engine and radiator cool and loosen the radiator cap or drain plugs slowly.

1. Open the engine hood.

< TB153FR >

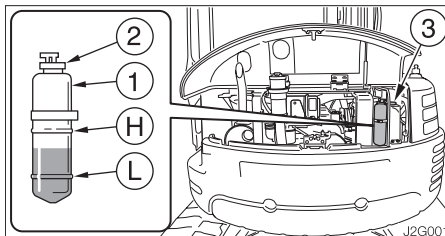

< TB180FR >

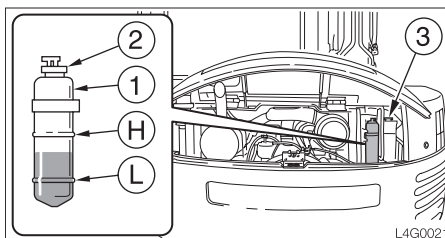

2. Gradually loosen the radiator cap (3) to release the internal pressure, then remove.

< TB153FR >

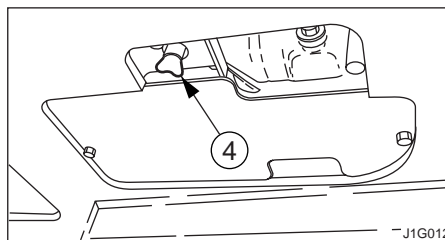



< TB180FR >

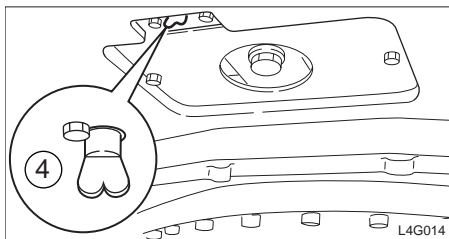

3. Place a pan for catching the spent coolant under the drain plug (4), then loosen the drain plug (4) and drain the coolant.

4. Tighten the drain plug (4), then add a little cleaning agent and tap water to the radiator until it is full. Take your time doing this.

Follow the manufacturer's instructions when using the cleaning agent.

5. Run the engine at a low idle for about 30 minutes. For the first 5 minutes after starting it, pay attention to the level of the cleaning fluid, and add tap water if the level drops.

6. Stop the engine and drain the cleaning fluid.

7. Tighten the drain plug (4), add tap water, run the engine at a low idle for about 10 minutes, then stop the engine and drain the water.

Clean repeatedly until the drained water is clear.

8. After cleaning is completed, tighten the drain plug (4) and add new coolant up to the specified level.

9. Run the engine at a low idle, bleed the air, then stop the engine once the coolant level stabilizes at the specified level.

10. Check the coolant level, then tighten the radiator cap (3).

11. Clean the inside of the reserve tank (1), then add coolant up to the upper limit (H).



Replacing the Air Cleaner Element

WARNING

Stop the engine and allow the machine to cool down before performing maintenance.

- The engine, muffler, radiator and many other parts of the machine are hot directly after the engine is stopped. Touching these parts will cause burns.

IMPORTANT: Do not use an element if its flutes, gaskets or seals are damaged.

Supplement: Do not remove and clean the inner element (option). Replace the inner element every 1000 hrs. or after every 3 cleaning of the outer element. (whichever comes first)

< TB153FR >

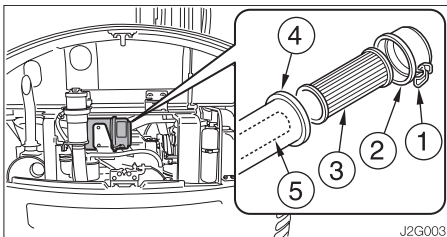

< TB180FR >

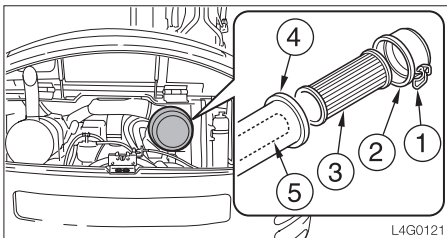

1. Open the engine hood.
2. Loosen the clamp (1) and remove the dust cup (2).

3. Clean the inside of the dust cup (2).
4. Remove the element (3).
5. Cover the intake hole at the back of the body (4) with cloth or tape to prevent dirt from getting in.
 - < If equipped with the inner element >
Do not yet remove the inner element (5).
6. Clean the inside of the body (4).
7. Remove the cloth or tape applied in step 5.
 - < If equipped with the inner element >
Remove the inner element (5).
8. Install the new elements.
9. Install the dust cup (2) with the "TOP" mark at the top, then fasten it with the clamp (1).



Replacing the Air Breather Filter

WARNING

Oil may spurt out if caps or filters are removed or pipes disconnected before releasing the pressure in the hydraulic system.

- Gradually press the air breather button to relieve tank pressure.

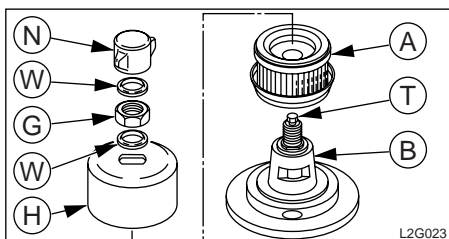

1. Remove cap nut (N) on the air breather.
2. Press button (T) and bleed the air from the tank.
3. Remove seal washers (W) and nut (G).
4. Remove cover (H).
5. Replace filter (A), making sure it is in the proper direction.
6. Line up the cut section of body (B) and cover (H) and install.
7. Install seal washers (W) and nut (G).
8. Tighten securely by hand with cap nut (N).

Replacing the Travel Motor Gear Oil

Refer to page 133 “Replacing the Travel Motor Gear Oil”.

Inspecting and Adjusting the Engine Valve Clearance

This operation requires experience. Have it performed by a Takeuchi sales or service outlet.

Retightening the Engine Cylinder Head Bolts

This operation requires experience. Have it performed by a Takeuchi sales or service outlet.

Inspecting the Engine Fuel Injection Pressure and Spray Condition

This operation requires experience. Have it performed by a Takeuchi sales or service outlet.



Replacing the Hydraulic Oil and Cleaning the Suction Strainer

⚠ WARNING

- **Stop the engine and allow the machine to cool down before performing maintenance.**
- **The engine, hydraulic lines and many other parts of the machine are hot directly after the engine is stopped. Touching these parts will cause burns.**
- **The hydraulic fluid is also hot and under high pressure. Be careful when loosening caps and plugs. Working on the machine under these conditions could result in burns or injuries due to the hot oil spurting out.**
- **Oil may spurt out if caps or filters are removed or pipes disconnected before releasing the pressure in the hydraulic system.**
- **Gradually press the air breather button to relieve tank pressure.**
- **When removing plugs or screws or disconnecting hoses, stand to the side and loosen slowly to gradually release the internal pressure before removing.**

1. Slew 45° clockwise and set the machine to the hydraulic oil level inspection posture. Refer to page 122 “Inspecting the Hydraulic Oil Level and Replenishing”.

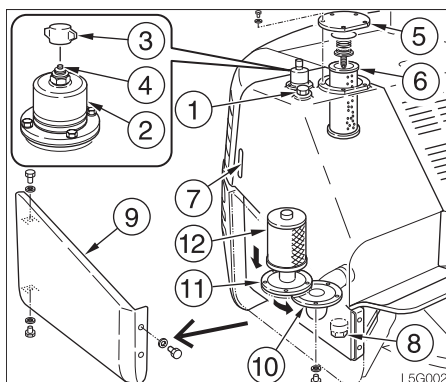

2. Remove cap nut (3) on the air breather (2).
3. Press button (4) and bleed the air from the tank.
4. Replace the air breather filter.
Refer to page 141 “Replacing the Air Breather filter”.
5. Remove the plug (1).
6. Loosen the bolts, and remove the flange (5).
7. Remove the return filter (6).
8. Place a pan for catching the spent oil under the drain plug (8).
9. Loosen the drain plug (8) and drain the hydraulic oil.
10. Loosen the bolts, and remove the cover (9).
11. Loosen the bolts, and remove the flange (10).
12. Shift the flange (10) to the right.
13. Remove the flange (11) and suction strainer (12) and clean them.
14. Clean the inside of the hydraulic tank.
15. Install the new return filter and flange (5).
16. Install the suction strainer (12) to the flange (11).
17. Install the flange (11) and (10).
18. Tighten the drain plug (8).
19. Add hydraulic oil up to the middle of the sight gauge (7).



20. Tighten the plug (1).
21. Follow the procedure next “Bleeding the air” to bleed the air from the hydraulic oil circuit.
22. Set the machine to the hydraulic oil level inspection posture and inspect the level once the temperature of the oil has dropped.
Refer to page 122 “Inspecting the Hydraulic Oil Level and Replenishing”.

Bleeding the air

IMPORTANT: After replacing the hydraulic oil, bleed the air from the hydraulic oil circuit and hydraulic devices. Failure to do so may damage the hydraulic devices.

● Hydraulic pump

1. Tilt up the platform.
Refer to page 154 “Tilting Up the Platform”.

< TB153FR >

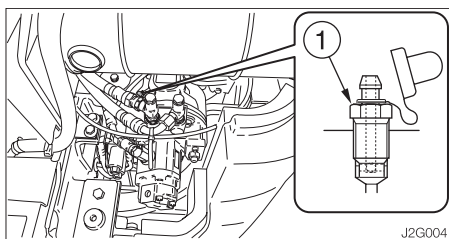

2. Loosen the hydraulic pump's air bleeding plug (1).
3. Once hydraulic oil overflows from the hole in the air bleeding plug (1), tighten the plug.

< TB180FR >

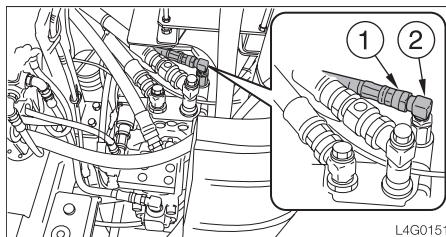

2. Disconnect the drain hose (1) from the hydraulic pump.
3. Once hydraulic oil overflows from the elbow (2), connect the drain hose (1).

● Slew motor

< TB153FR >

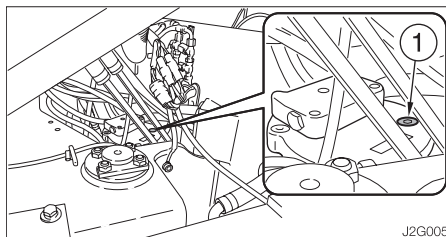

< TB180FR >

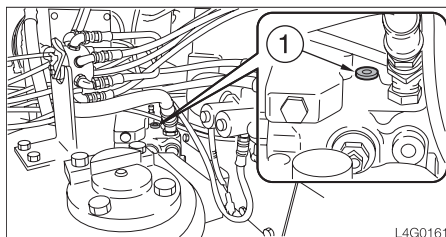

4. Loosen the air bleeding plug (1).
5. Once hydraulic oil overflows from the hole in the air bleeding plug (1), tighten the plug.
6. Lower the platform.

**● Cylinders**

7. Start the engine and run it at low idle for 10 minutes.
8. Set the engine to a low idle, then extend and contract all the cylinders 4 or 5 times, without going to the stroke end.
9. Run the engine at high speed, then extend and contract all the cylinders 4 or 5 times, without going to the stroke end.
10. Set the engine back to a low idle, then extend and contract all the cylinders 4 or 5 times to the stroke ends.

Inspecting the Engine Fuel Injection Timing

This operation requires experience. Have it performed by a Takeuchi sales or service outlet.

Inspecting the Engine Fuel Injection Valve

This operation requires experience. Have it performed by a Takeuchi sales or service outlet.



Inspecting and Replenishing the Windshield Washer Fluid

Use a windshield washer fluid designed specifically for motor vehicles. Follow the instructions including with the washer fluid.

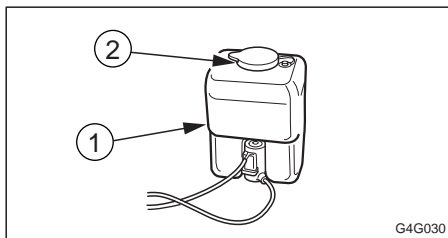

G4G030

Inspection

1. Open the cab door.
2. Inspect the washer tank (1) and add washer fluid if the level is low.

Replenishment

1. Mix the washer fluid to the prescribed concentration.
2. Remove the cap (2) and add washer fluid.
3. Reinstall the cap (2).

Cleaning the Water Separator

WARNING

- Do not smoke or permit open flames while handling fuel or working on the fuel system.
- Stop the engine in a well-ventilated place and allow it to cool down before performing maintenance.
- Clean up spilled fuel immediately.

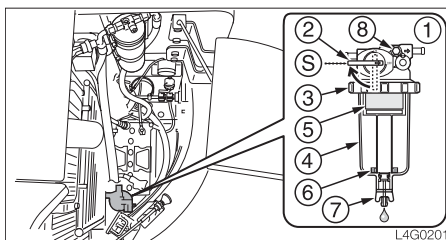

L4G0201

Ⓢ : Closed

1. Open the rear cover.
2. Close the lever (2).
3. Loosen the ring (3), then remove the case (4), element (5) and indicator ring (6) and clean them.
4. Inspect the O-ring, and if there are any scratches or other irregularities, replace it.
5. Assemble the indicator ring (6), case (4) and element (5) and tighten the ring (3).
6. Open the lever (2) and bleed the air.

Bleeding the air from the fuel system

Refer to page 168 "Bleeding the Air from the Fuel System".



Lubricating the Levers

WARNING

Set the machine to the parking posture, stop the engine, remove the starter key and store it. Failure to do so may result in the machine moving abruptly, leading to serious injury or death.

If the levers or pedals no longer move smoothly, supply grease.

Operating levers

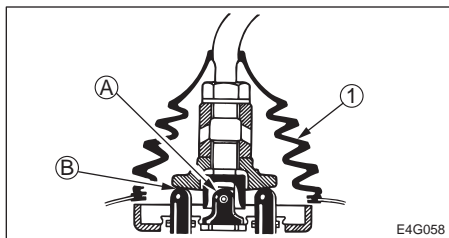

1. Remove the lower mount section of the boot (1) and turn it upwards.
2. Wipe off the old grease.
3. Supply grease to points (A) and (B).
4. Set the boot (1) back as it was.

Travel levers

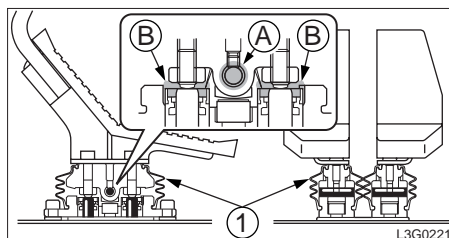

1. Remove the lower mount section of the boots (1) and turn it upwards.
2. Wipe off the old grease.
3. Supply grease to points (A) and (B).
4. Set the boots (1) back as it was.

Offset pedal

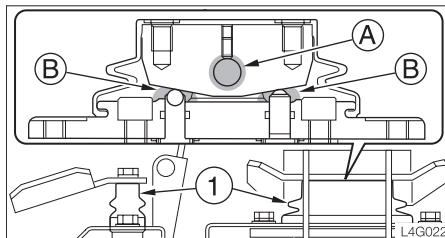

1. Remove the lower mount section of the boot (1) and turn it upwards.
2. Wipe off the old grease.
3. Supply grease to points (A) and (B).
4. Set the boot (1) back as it was.

Blade lever < TB180FR >

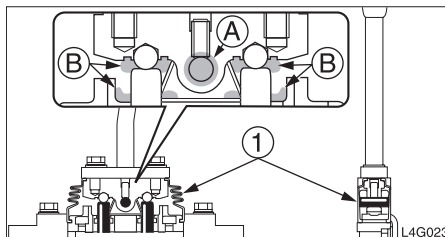

1. Remove the lower mount section of the boot (1) and turn it upwards.
2. Wipe off the old grease.
3. Supply grease to points (A) and (B).
4. Set the boot (1) back as it was.



Adjusting the Gap Between the Bucket and Arm < TB180FR >

⚠ WARNING

- Before performing maintenance or repairs under the machine, set all working equipment against the ground or in the lowermost position.
- To prevent unexpected movement, securely block the working equipment when adjusting.

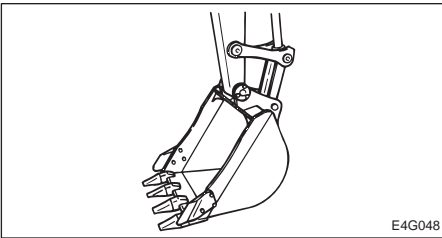

1. Ground the bucket as shown on the diagram above in a stable position.
2. Check that the bucket does not move, then set the safety lock lever to the locked position and stop the engine.

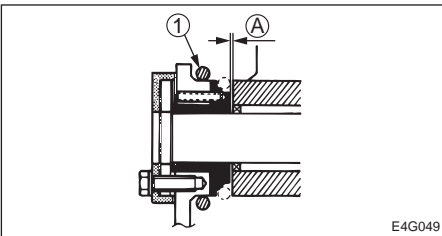

3. Slide the O-ring (1) to bring the gap (A) into view and measure the width of the gap (A).
The gap (A) should be 0.5 mm (0.02 in.). Swing the bucket slightly to the left and lightly press the arm point to the left side of the bucket (the side without an adjuster).

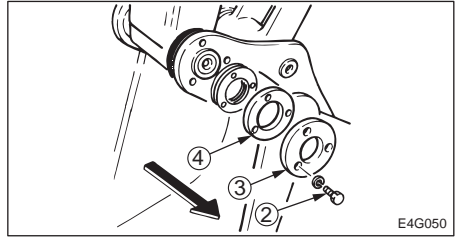

4. Remove the three bolts (2), the end plate (3) and flange (4).

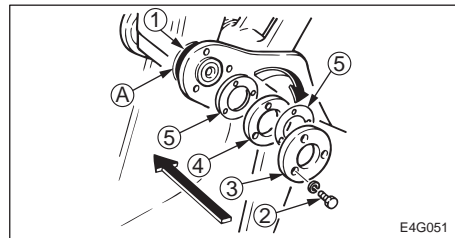

5. Extract adjustment shim (5) from between flange (4) and the bucket body according to gap (A).
Adjustment shim thickness : 0.5 mm (0.02 in.)
Be careful that the gap is no less than 0.5 mm (0.02 in.) after adjustment.

Supplement

Example (for a gap of 2 mm or 0.08 in.) :
2 mm (X) – 0.5 mm (standard value)
= 1.5 mm (0.06 in.)
In the above example, three shims (5) should be removed.

6. Insert adjustment shim (5) removed in step 5 above between end plate (3) and flange (4) and fasten it in place with the three bolts (2).
 - Tightening torque for bolts (2)
54.9 N·m (40.5 ft·lb.)
7. Return the O-ring (1) to their original position.



Replacing the Bucket

⚠ WARNING

- Before performing maintenance or repairs under the machine, set all working equipment against the ground or in the lowermost position.
- If maintenance must be performed with the engine running, always work as a two person team with one person sitting in the operator's seat while the other works on the machine.
 - When performing maintenance, be sure to keep your body and clothing away from moving parts.
- Wear required appropriate equipment such as safety glasses and filter mask when using hammers, as metal fragments or other objects can fly and cause serious personal injury.
- When lining up the pin holes, always do so by sight. Your finger may be cut off if you stick it into the hole.

Removal

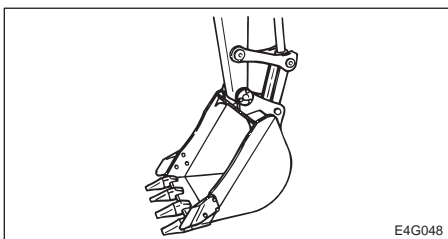

1. Ground the bucket as shown on the diagram above in a stable position.

Supplement: When removing pins, set the bucket so that it is just gently against the ground. If it is strongly against the ground, the resistance will be great and it will be difficult to remove the pin.

2. Set the safety lock lever to the locked position and stop the engine.
3. Remove the bolt (1).

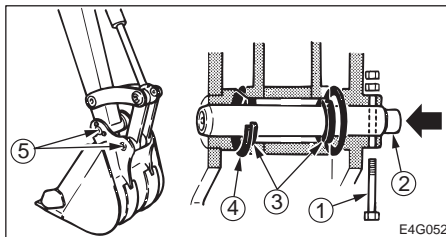

4. Hammer pin (2) out of the bucket.
5. Remove the bucket.
Inspect the pin seal (3) and replace it if it is deformed or damaged. (See next page.)

Installation

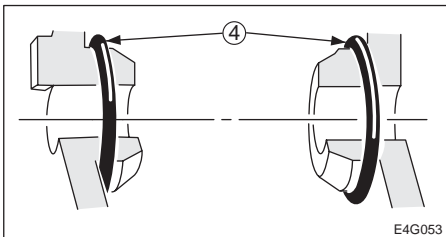

1. Set the bucket's O-ring (4) as shown on the diagram.

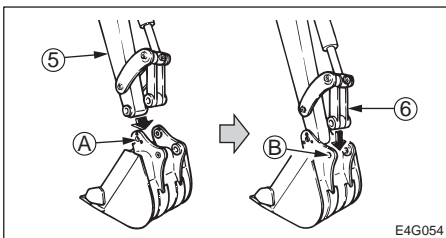

2. Line up pin hole (A) in the bucket with the pin hole in the arm (5), and install the pin (2).



3. Operate the cylinder, line up pin hole (B) in the bucket with the pin hole in the link arm (6), and install the pin (2).
2. Use a mallet to slowly press the pin seal in. Be careful not to damage the seal.

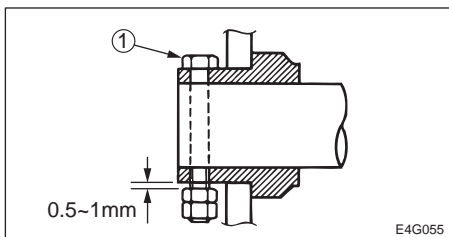

4. Line up the turn prevention holes, install the bolt (1), and the nuts. Be sure to leave a gap of about 0.5 ~ 1 mm (0.02 ~ 0.04 in.) between the nut and bucket bush, or the nut will come loose.

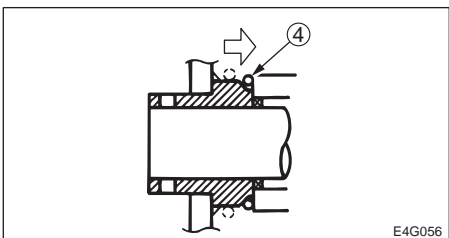

5. Adjust the gap between the bucket and the arm. Refer to page 134.
6. Slide the O-ring (4).

Replacing the pin seal

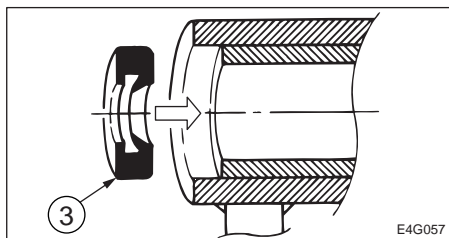

1. Set the pin seal (3) in the direction shown on the diagram above.



Replacing the Bucket Teeth and the Side Cutters < TB153FR >

Replace the bucket teeth and the side cutters when the tooth points or the side cutters are worn, before the adapter or the bucket is damaged.

WARNING

- Before performing maintenance or repairs under the machine, set all working equipment against the ground or in the lowermost position.
- To prevent unexpected movement, securely block the working elements when repairing or replacing the bucket teeth and the side cutters.
- Wear required appropriate equipment such as safety glasses when using hammers, as metal fragments or other objects can fly and cause serious personal injury.
- Do not allow unauthorized personnel in the work area.

• Bucket tooth

Removal

1. Clean the bucket and park the machine in a flat, safe place where the ground is hard.

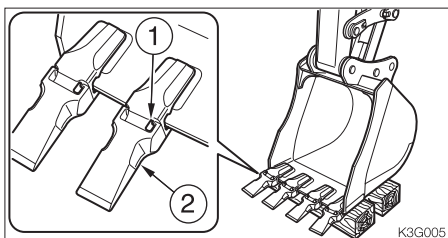

2. Set the bottom surface of the bucket flat and lower it on a block so that the locking pin (1) can be knocked out.

3. Remove the key, then check that the bucket is stable.

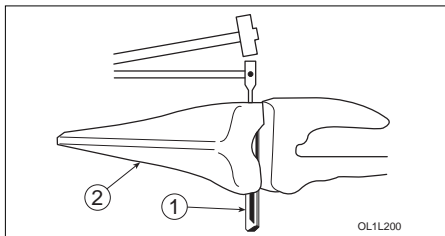

4. Place a rod against the locking pin (1) and knock the locking pin out by hammering against the rod. The rod should be round and thinner than the locking pin.

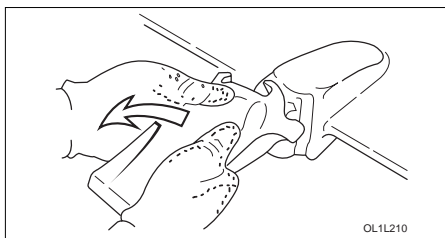

5. Remove the tooth point (2). Some tooth points (2) are of the type that are removed by turning (twisting) them counterclockwise. The same procedure can be used to remove the other tooth points.



Installation

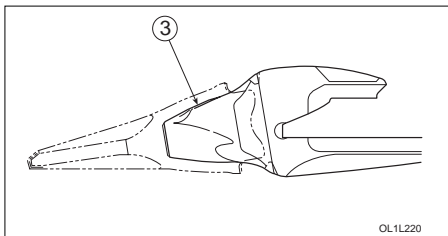

1. Clean the adapter nose (3).
If there is gravel or mud on the adapter nose, the tooth point will not go in all the way and the pin cannot be driven in.

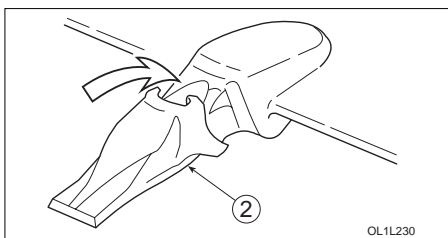

2. Put the tooth point (2) in the adapter nose (3).
Push in firmly until the tooth point (2) touches the tip of the adapter nose (3).
Some tooth points (2) are of the type that are installed by turning (twisting) them clockwise.

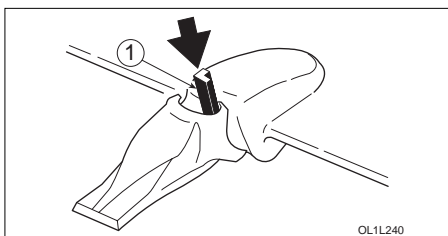

3. Insert the locking pin (1), making sure it is in the right direction.

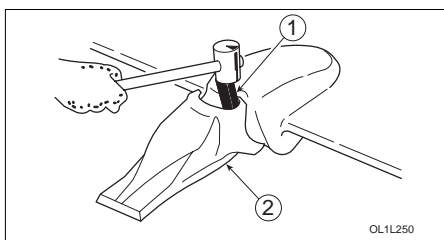

4. Drive in the locking pin (1) with a hammer until it is flush with the tip of the tooth point (2) ear.

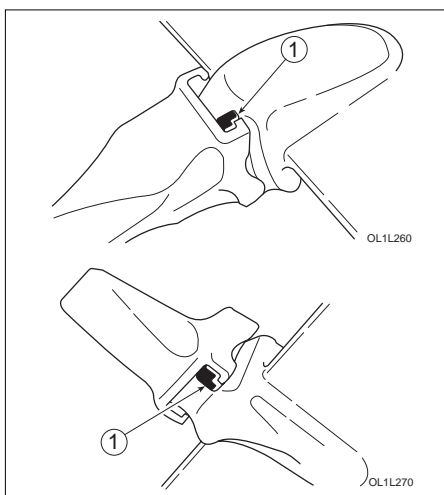

5. The locking pin (1) is now driven in.
The same procedure can be used to install the other tooth points.

- **Side cutter**

Refer to page 153 "Side cutter".



Replacing the Bucket Teeth and the Side Cutters < TB180FR >

Replace the bucket teeth and the side cutters when the tooth points or the side cutters are worn, before the adapter or the bucket is damaged.

⚠ WARNING

- Before performing maintenance or repairs under the machine, set all working equipment against the ground or in the lowermost position.
- To prevent unexpected movement, securely block the working elements when repairing or replacing the bucket teeth and the side cutters.
- Wear required appropriate equipment such as safety glasses when using hammers, as metal fragments or other objects can fly and cause serious personal injury.
- Do not allow unauthorized personnel in the work area.

● Bucket tooth

Removal

1. Clean the bucket and park the machine in a flat, safe place where the ground is hard.

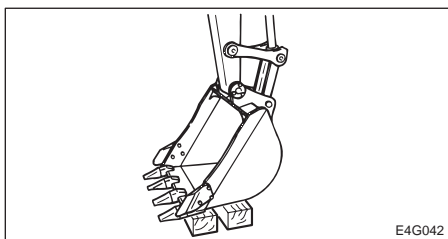

2. Set the bottom surface of the bucket flat and lower it on a block so that the locking pin can be knocked out.

3. Remove the key, then check that the bucket is stable.

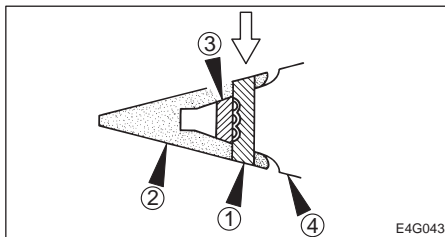

4. Remove locking pin (1) and remove point (2).
5. Take out rubber pin lock (3) and check whether it is still usable.

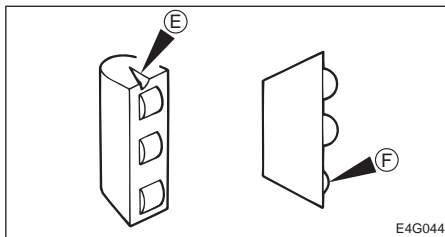

- E When these are cracks in the rubber and it seems like the roller is about to come off.
- F When the roller becomes dented when pressed with a finger.

Installation

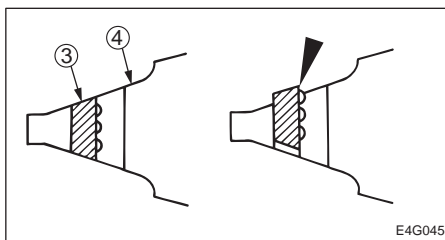

1. Push rubber pin lock (3) into welding adaptor (4).



Do not let the rubber pin lock stick out past the welding adaptor surface.

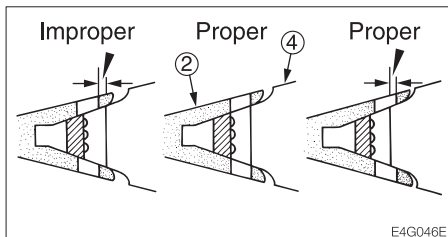

2. Install point (2) onto welding adaptor (4).
 - Insert the point so that the surface behind the point's pin hole is flush or deeper than the surface behind the welding adaptor's pin hole.

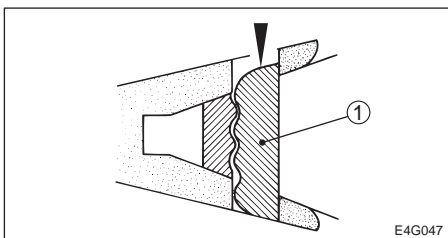

3. Drive in locking pin (1).

After driving in the locking pin, use a pin with the same surface as the point surface. Do not use worn locking pins.

● Side cutter Installation

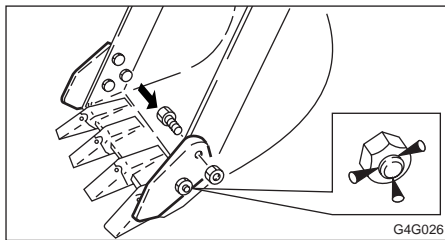

1. Insert the bolts from the inner of the bucket and tighten the nuts.
 - Tightening torque: 241 N·m (178 ft·lb)
2. Caulk the bolts with a punch at three spots along the periphery of the screw to prevent the nuts from coming loose.



Tilting Up the Platform

For inspection and maintenance, the platform is designed so that it can be tilted up.

WARNING

- **Raising or lowering the platform while the engine is running may cause the machine to move, and cause serious injury or death. Lower the working equipment to the ground and stop the engine before raising or lowering the platform.**
- **When the platform is tilted up, support it firmly with the stopper to prevent it from falling.**

IMPORTANT: Lower the working equipment to the ground before raising the platform. If not avoided, could result in the boom from touching the cab.

Raising (Tilt up)

1. Select a firm, level surface, lower the working equipment to the ground, and stop the engine.
2. Raise the safety lock lever to engage the lock.

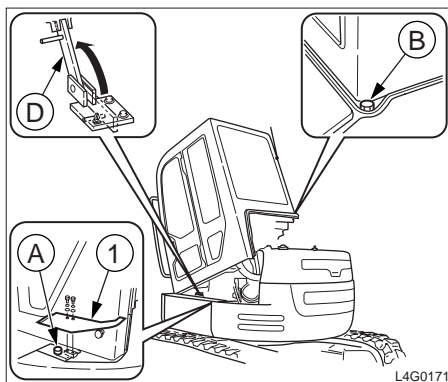

3. Loosen the bolts, and remove the cover (1).

4. Remove the lock bolts (A) and (B).
 5. Slowly raise the platform. (Tilt up : 30°)
 6. Lift stopper (D) and insert it into the platform's holder.
- If you need to run the engine while the platform is raised follow these steps.
7. Make sure that all levers and pedal are in neutral positions.
 8. Turn the throttle controller to the low idling position.
 9. Start the engine.
 10. Be sure to stop the engine after inspection and maintenance.

Lowering

1. Remove the stopper (D), and set back to the original position.
2. Lower the platform.
3. Tighten the lock bolts (A) and (B).
4. Install the cover (1).



Inspecting the Rubber Crawlers

Repair or replace the rubber crawlers if their conditions are as described below. Consult a Takeuchi sales or service outlet about repairs or replacement.

Rubber crawler

Replace the crawler if the entire crawler is stretched and cannot be adjusted.

(1) Lug

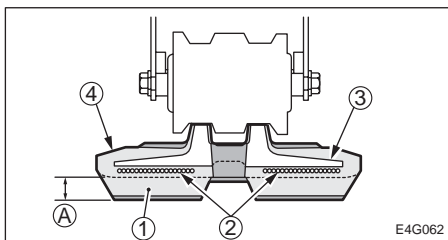

Replace if the height of (A) is 5 mm (0.2 in.) or below.

(2) Steel cord

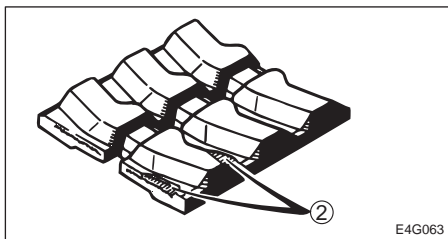

Replace if the steel cord is exposed over 2 or more links.

Replace if half or more of the steel cords on one side are cut.

(3) Metal core

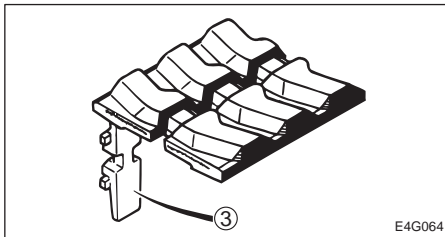

Replace if even one metal core is off.

(4) Rubber

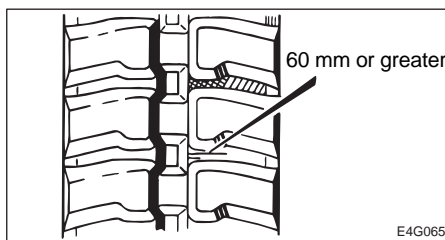

Repair if there are cracks of 60 mm (2.4 in.) or greater in length.

If the steel cord is visible, repair as soon as possible, regardless of the length of the crack.



Replacing the Rubber Crawlers < TB153FR >

WARNING

- If you must work beneath the raised machine or equipment, always use wood blocks, jack-stands or other rigid and stable supports. Never get under the machine or working equipment if they are not sufficiently supported. This procedure is especially important when working on hydraulic cylinders.
- If maintenance must be performed with the engine running, always work as a two-person team with one person sitting in the operator's seat while the other works on the machine.
 - When performing maintenance, be sure to keep your body and clothing away from moving parts.

Removal

1. Fully release the tension of the rubber crawler.

Refer to page 128 "Inspecting and Adjusting the Crawler Tension".

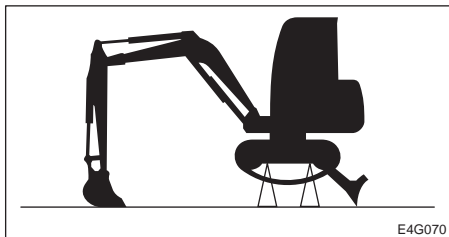

2. Use the working equipment to lift the body.

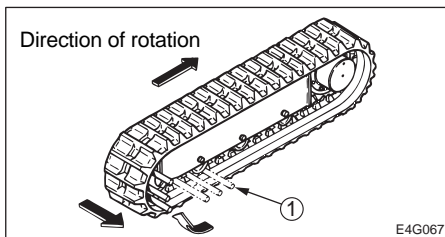

3. Set an iron pipe (1) in the rubber crawler and turn the sprocket slowly in the reverse direction.
4. Turn until the iron pipe (1) is directly next to the idler and the rubber crawler lifts away from the idler, then stop turning the sprocket.
5. Slide the rubber crawler sideways and remove it from the crawler frame. Remove the other rubber crawler using the same procedure.

Installation

1. Use the working equipment to lift the body.

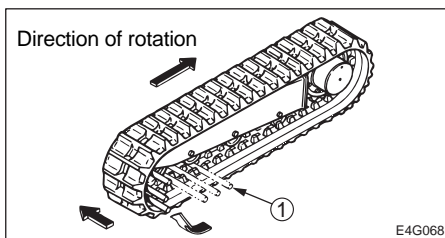

2. Set the rubber crawler on the sprocket.
3. Set an iron pipe (1) in the rubber crawler and turn the sprocket slowly in the reverse direction.
4. Turn until the iron pipe (1) is directly next to the idler and the rubber crawler lifts away from the idler, then stop turning the sprocket.
5. Slide the rubber crawler inward, engage it on the idler, then pull out the iron pipe.



6. Check that the rubber crawler is securely engaged on the sprocket and idler.

7. Tighten the rubber crawler to the standard tension.

Refer to page 128 “Inspecting and Adjusting the Crawler Tension”.

8. Install the other rubber crawler using the same procedure.



Replacing the Rubber Crawlers < TB180FR >

WARNING

- Replacements should always be done by two persons, with one person acting as operator and following instructions from the other.
- The machine must be elevated before replacing the rubber crawler belts. Be careful not to allow the machine to fall when replacing crawler belts, since this could be extremely dangerous. Slowly lower the machine on the side of the idler and remove the crawler belts.

This machine uses a hydraulic cylinder to adjust the tension of the crawler belts. Note that it is not necessary to regularly perform adjustments of the tension of the belt itself.

IMPORTANT: During the replacement procedure, only start the engine when raising and lowering the machine body. Otherwise, always keep the engine off.
IMPORTANT: When the travel speed switch is set to the 2nd speed side while the engine is running, the tensioning cylinder rods extend and the crawlers are tightened.

Removal

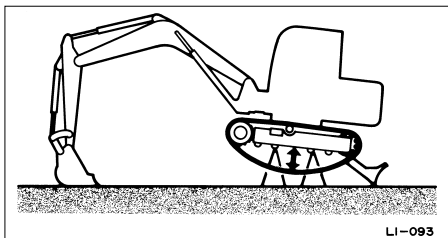

1. Start the engine and raise the machine body with the hoe attachment and dozer blade.

2. Stop the engine.

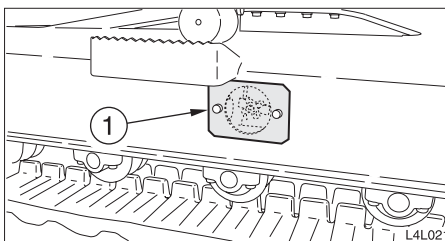

3. Remove the valve covers (1) at the center of the left and right crawler frames.

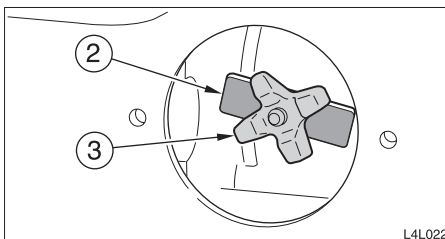

4. Loosen the lock plate (2) counterclockwise.
5. Turn the valve handle (3) counterclockwise to loosen the tension of the crawler.
6. Once the crawler is completely loose, tighten the valve handle (3).
7. Tighten the lock plate (2).
8. Do the same for the other side.

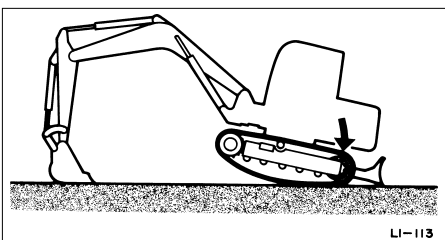

9. Slowly lower the dozer blade side of the machine body, by the dozer blade lever. (Do not start the engine.)



10. Ground the crawlers and lower the machine body so that the crawler slack is maximum.
11. When the crawlers come away from the idlers, slide the crawlers to the outside and remove them.
12. Disengage the crawlers and sprockets, then remove the crawlers from the crawler frames.

Installation

1. Engage the crawlers with the left and right sprockets.
2. Set the left and right crawlers on the idlers.
3. Start the engine.
4. Press the travel speed switch once and set it to the 2nd speed side. The left and right crawlers are tightened simultaneously.

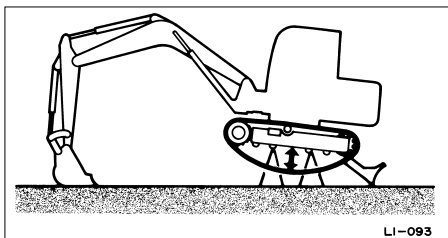

5. Check that the crawlers are properly tightened. Standard value (A). Refer to page 128 "Inspecting and adjusting the Crawler Tension".



Procedures for storage

If the machine is to be stored for 30 days or more, store it indoors. If it must be stored outdoors, stop it on wood laid out on a flat surface and place a waterproof cover over it so that it stays dry.

1. Clean the machine.
2. Inspect for oil leakage, water leakage and loose nuts and bolts.
3. Add fuel and replace the hydraulic oil and oil.
4. To prevent rusting and freezing, replace the engine coolant with long-life coolant (LLC).

Refer to page 138 "Cleaning the Engine Cooling System".

5. Use the grease gun to supply grease to the grease nipples.
6. Fully contract the bucket and arm cylinders and ground the bucket and dozer blade.
7. Apply rust-prevention oil to the hydraulic cylinder rods.
8. Disconnect the cable from the battery's "-" terminal and cover the battery to prevent freezing.

During storage

WARNING

- **Do not operate the engine in an enclosed area without adequate ventilation.**
- **If natural ventilation is poor, install ventilators, fans, exhaust extension pipes or other artificial venting devices.**

1. To prevent rusting, operate the machine once a month so that the oil is fully circulated.
2. Inspect the battery and recharge it if necessary.
Have the battery charged by a Takeuchi sales or service outlet.

Starting the machine after storage

IMPORTANT: If the "Procedures for storage" have not been performed and the machine has been stored for a long period of time, consult a Takeuchi sales or service outlet before reusing the machine.

1. Wipe off the rust-prevention oil that was applied to the hydraulic oil cylinders' piston rods.
2. Add fuel, oil and grease to all parts.



TROUBLESHOOTING

Symptoms that are not Malfunctions	162
If the Engine Overheats	163
If the Battery Goes Dead	164
If a Fuse Blows	166
After the Fuel Runs Out	168
If a Warning Lamp Flashes	169
Other Symptoms	170
To Lower the Boom	172
Towing	174



The following symptoms are not malfunctions:

- Performance decreases when an attachment weighing more than a standard arm or bucket is mounted.

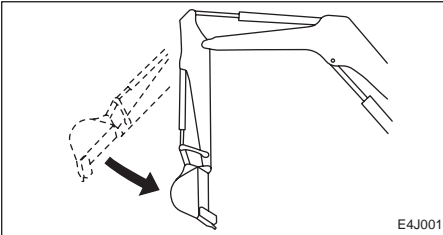

E4J001

- When the arm reaches the vertical position while contracting it while the engine is running at low speed, the contracting speed slows down momentarily.

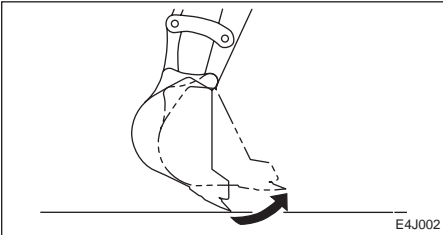

E4J002

- When the bucket teeth reach the horizontal position while the engine is running at low speed, the speed of bucket movement slows down momentarily.
- The slew motor produces noise at the beginning and end of the slewing operation.
- The travel motor produces noise when stopped suddenly during high speed travel.
- The control valve produces noise if excessive force is applied to the working equipment and when the stroke end is reached.



WARNING

- Do not open the engine hood when there is steam coming from the engine room. The steam or hot water may spurt out, resulting in burns.
- Do not remove the radiator cap or drain plugs when the coolant is hot. Stop the engine, let the engine and radiator cool and loosen the radiator cap or drain plugs slowly.
- Stop the engine and allow the machine to cool down before performing inspection and maintenance.

The following symptoms indicate overheating :

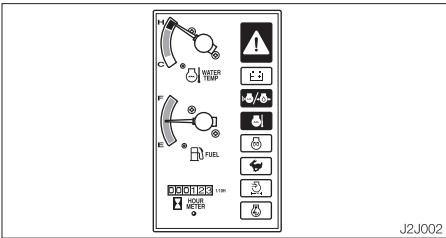

- An alarm is sounded and the coolant temperature warning lamp, engine emergency lamp flashes.
When the engine oil pressure / coolant level warning lamp is flashing simultaneously, the coolant level is low.
- The water temperature gauge is in the red zone.
- The engine slows down and the force decreases.
- Steam comes from the engine room.

Procedure

1. Park the machine in a safe place.
2. Inspect whether the engine oil pressure/coolant level warning lamp is flashing or if there is steam coming out when the engine hood is closed.
3. If there is steam, stop the engine immediately and contact a Takeuchi sales or service outlet for repairs.
If the engine oil pressure/coolant level warning lamp is off, run the engine at low idle and let the water temperature decrease.
4. Once the water temperature gauge drops to the green zone, stop the engine.
5. Once the engine is cool, perform the following inspections and procedures:
 - Fan belt slack Adjust. Refer to page 127.
 - Coolant level Add. Refer to page 120.
 - Water leakage Repair.
 - Radiator fins Clean. Refer to page 136.
 - Sediment in cooling system Clean. Refer to page 138.

If the problem persists after the above procedures are taken, contact a Takeuchi sales or service outlet for repairs.



The following symptoms indicate that the battery is dead :

- The starter motor does not turn or turns weakly, and the engine does not start.
- The horn is weak.

Procedure

Use jumper cables and start the engine using the rescue vehicle's battery.

WARNING

- **Use jumper cables only in the recommended manner. Improper use of jumper cables can result in battery explosion or unexpected machine motion.**
 - Do not let the problem vehicle and rescue vehicle touch each other.
 - Do not let the “+” and “-” clips of the jumper cables touch each other.
 - Connect the jumper cables to the “+” terminals first, and disconnect them from the “-” terminals (ground) first.
 - Connect the final clip of the jumper cable to a point as far away from the battery as possible.
- Use safety glasses when using jumper cables to start the machine.

IMPORTANT: Use jumper cables and clips of a size suited to the battery's capacity. Do not use damaged or corroded jumper cables and clips.

IMPORTANT: The rescue vehicle's battery must have the same capacity as the problem vehicle's battery.

IMPORTANT: Connect the clips securely.

Connecting the jumper cables

IMPORTANT: Set the starter keys of both the rescue vehicle and problem vehicle to the **OFF** position.

Refer to page 41 “Rear Cover”.

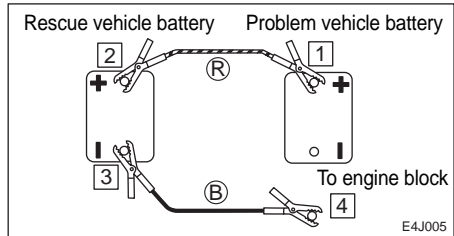

1. Connect the clip of jumper cable (R) to the problem vehicle's “+” terminal.
2. Connect the other clip of jumper cable (R) to the rescue vehicle's “+” terminal.
3. Connect the clip of jumper cable (B) to the rescue vehicle's “-” terminal.
4. Connect the other clip of jumper cable (B) to the problem vehicle's engine block. Connect the clip as far from the battery as possible.

Starting the engine

1. Check that the clips are securely connected to the terminals.
2. Start the rescue vehicle's engine and run it at high speed.
3. Start the problem vehicle's engine.

**Disconnecting the jumper cables**

Once the engine starts, disconnect the jumper cables following the connection procedure in reverse order.

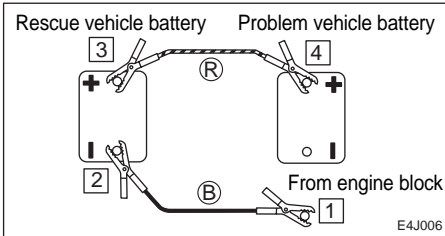

1. Disconnect the clip of jumper cable (B) from the problem vehicle's engine block.
2. Disconnect the other clip of jumper cable (B) from the rescue vehicle's "-" terminal.
3. Disconnect the clip of jumper cable (R) from the rescue vehicle's "+" terminal.
4. Disconnect the other clip of jumper cable (R) from the problem vehicle's "+" terminal.

Recharging

Have a Takeuchi sales or service outlet recharge batteries that have gone dead.



If a light does not turn on or the electric system does not operate, a fuse may be blown. Inspect the fuses.

Inspecting and Replacing the Fuse

WARNING

If the fuse blows as soon as it is replaced, there is a problem with the electric system. Continued use may lead to fire. Consult a Takeuchi sales or service outlet.

1. Turn the starter key to the OFF position and stop the engine.

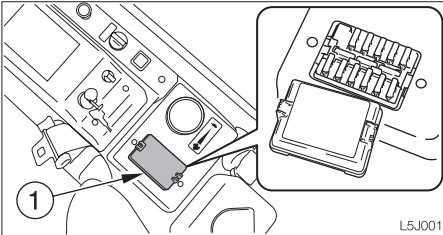

2. Open the fuse box cover (1).
3. Inspect for any blown fuses.

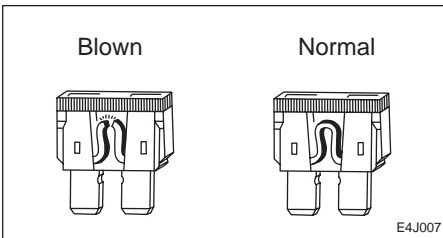

4. If a fuse is blown, replace it with a spare fuse of the same capacity.

Fuse Layout and Circuits Protected < TB153FR >

Capacity	Protected circuit	Capacity	Protected circuit
20A	Horn		
10A	Radio, Interior light	10A	Controller
10A	Lever lock	30A	Stop solenoid
30A	Lights	5A	Controller (ACC), Accessory relay
30A	Wiper, Cigarette lighter	5A	Instrument cluster Feed pump
10A	Optional	5A	Interference prevention

< TB180FR >

Capacity	Protected circuit	Capacity	Protected circuit
20A	Horn		
10A	Radio, Interior light	10A	Throttle controller
10A	Lever lock	30A	Emergency stop relay
5A	Lights	5A	Controller (ACC), Accessory relay
30A	Wiper, Cigarette lighter	5A	Instrument cluster
10A	Optional	5A	Interference prevention



Inspecting the Fusible Link

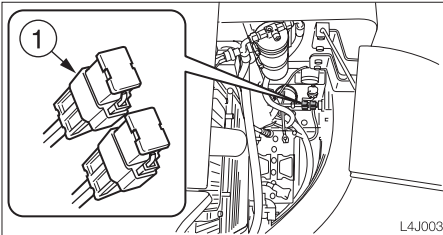

If the power is not switched on after turning the starter switch to the ON position, the cartridge type fusible links (1) might be blown open. Open the cover located at below of the left operating lever and inspect. If the fusible link is blown, please contact your dealer.

Supplement: A fusible link is a large piece of fuse wiring which is mounted in a circuit which carries a large electrical current. Link a regular fuse, the fusible link protects the electrical parts and wiring from damage due to abnormally large currents.



Bleeding the Air from the Fuel System

1. Add fuel.

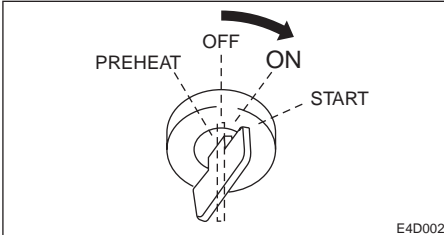





2. Turn the starter key to the ON position and hold it there for about 20 seconds.
The automatic air bleeder bleeds the air from the fuel system.

Supplement: Air in the fuel system can make it difficult to start the engine and cause engine problems. Also bleed the air when the fuel tank is emptied or air in the fuel system.

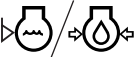
**If a Warning Lamp Flashes**

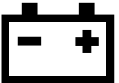
If an alarm is sounded or a warning lamp starts flashing during operation, park the machine in a safe place and perform the procedures described below.

Warning lamp	Lamp name	Procedure
 G4B009	Engine emergency lamp	<p>A problem has occurred in the engine lubrication system or cooling system.</p> <ul style="list-style-type: none"> • When there is a problem in the engine lubrication system or coolant level, the engine oil pressure / coolant level warning lamp flashes simultaneously. • When the coolant water temperature has risen irregularly, the coolant temperature warning lamp flashes simultaneously. <p>For the procedures, refer to the respective warning lamps below.</p>
 L3J004	Engine oil pressure/coolant level warning lamp	<p>Inspect the engine oil level or coolant level. If the lamp is flashing even though the level is normal or if it continues flashing after oil or coolant are supplied, consult a Takeuchi sales or service outlet.</p> <p>Refer to page 120 or 121 "Inspecting and replenishing the coolant" or "Inspecting and Replenishing the Engine Oil".</p>
 C4B012	Coolant temperature warning lamp	<p>The coolant temperature has risen irregularly and the engine is overheating.</p> <p>Refer to page 163 "If the Engine Overheats".</p>
 OSOB080	Battery charge warning lamp	<p>There is a problem with the fan belt or charger. Inspect the fan belt for slack or breakage and adjust as necessary. If the lamp continues flashing after maintenance, there is a problem with the charger. Consult a Takeuchi sales or service outlet.</p> <p>Refer to page 127 "Inspecting and Adjusting the Fan Belt".</p>
 G4B010	Air cleaner warning lamp	<p>The air cleaner filter is clogged.</p> <p>Refer to page 134 "Cleaning the Air Cleaner".</p>



For symptoms not included on the table below or if the problem persists after the proper procedures have been taken, consult a Takeuchi sales or service outlet.

Symptom	Main cause	Procedure
Left and right operating levers do not move smoothly	<ul style="list-style-type: none"> ● Insufficient grease on left and right operating levers 	<ul style="list-style-type: none"> ● Add grease. Refer to page 146.
Travel levers, offset pedal or blade lever do not move smoothly	<ul style="list-style-type: none"> ● Insufficient grease on travel levers, offset pedal or blade lever ● Stretched wire < TB153FR > (Blade lever) 	<ul style="list-style-type: none"> ● Add grease. Refer to page 146. ● Adjust or replace. (Request at a sales or service outlet)
Working equipment, auxiliary hydraulics, slewing or traveling operation not possible	<ul style="list-style-type: none"> ● Safety lock lever is raised ● Fuse is blown 	<ul style="list-style-type: none"> ● Lower the safety lock lever. Refer to page 53. ● Replace the fuse. Refer to page 166.
Digging force is insufficient	<ul style="list-style-type: none"> ● Insufficient hydraulic oil level ● Hydraulic oil is not heated ● Air cleaner is clogged ● Hydraulic oil is not of suitable type 	<ul style="list-style-type: none"> ● Replenish to the prescribed level. Refer to page 122. ● Perform the warm-up procedure. Refer to page 76. ● Clean the air cleaner. Refer to page 134. ● Replace the hydraulic oil. Refer to page 142.
Traveling is not possible or not smooth	<ul style="list-style-type: none"> ● Stones or foreign objects are stuck 	<ul style="list-style-type: none"> ● Remove the foreign object.
Machine does not travel straight forward	<ul style="list-style-type: none"> ● Stones or foreign objects are stuck ● Faulty crawler tension adjustment. 	<ul style="list-style-type: none"> ● Remove the foreign object. ● Adjust the crawler to the prescribed tension. Refer to page 128.
Travel speed cannot be changed	<ul style="list-style-type: none"> ● Fuse is blown 	<ul style="list-style-type: none"> ● Replace the fuse. Refer to page 166.
Slewing is not possible or not smooth	<ul style="list-style-type: none"> ● Insufficient grease on slew bearing 	<ul style="list-style-type: none"> ● Add grease. Refer to page 130.
Hydraulic oil temperature is too high	<ul style="list-style-type: none"> ● Insufficient hydraulic oil 	<ul style="list-style-type: none"> ● Replenish to the prescribed level. Refer to page 122.



Symptom	Main cause	Procedure
Starter motor turns but engine does not start	<ul style="list-style-type: none">● Insufficient fuel● Air in fuel system● Water in fuel system	<ul style="list-style-type: none">● Add fuel. Refer to page 122.● Bleed the air. Refer to page 168.● Drain the water. Refer to page 132.
Crawlers slip off	<ul style="list-style-type: none">● Crawlers are too loose● Tensioning cylinder valves are too loose < TB180FR >	<ul style="list-style-type: none">● Adjust the tension. Refer to page 128.● Increase the tension. Refer to page 158.
Engine exhaust is white or bluish	<ul style="list-style-type: none">● Excessive engine oil● Insufficient fuel	<ul style="list-style-type: none">● Adjust to the prescribed level. Refer to page 121.● Replace the fuel.
Engine exhaust is occasionally black	<ul style="list-style-type: none">● Air cleaner is clogged	<ul style="list-style-type: none">● Clean the air cleaner. Refer to page 134.
Irregular noise is produced from the engine (combustion or mechanical noise)	<ul style="list-style-type: none">● Low quality fuel is being used● Engine is overheating● Damage in muffler	<ul style="list-style-type: none">● Replace the fuel.● If the Engine Overheats Refer to page 163.● Replace the muffler. (Request at a sales or service outlet.)



If the hoe attachment must be lowered to the ground while the engine is stopped, use the following procedure to do so. This operation is dangerous and requires experience. Have it performed by a Takeuchi sales or service outlet.

Procedure

⚠ WARNING

- Do not approach in the area of the ground where the hoe attachment is to be lowered. You may be hit by dirt falling out of the bucket or the hoe attachment as it drops.
- Turn the port relief valve's set screw slowly so that the boom lowers slowly. Do not turn the screw more than the specified amount.

< TB180FR >

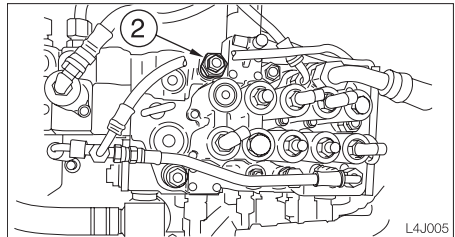
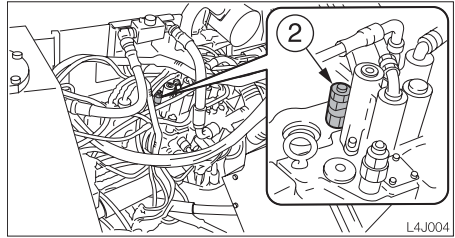

< TB153FR / TB180FR >

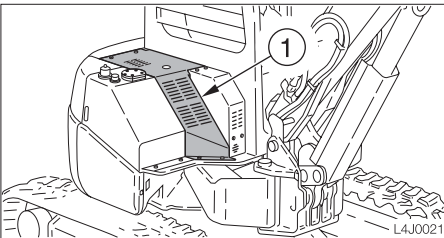
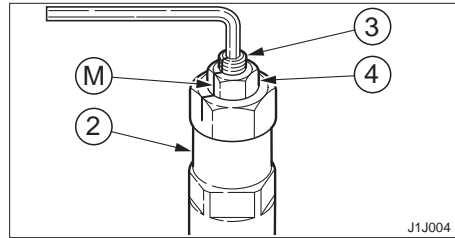

1. Loosen the bolts and remove the cover (1).

< TB153FR >

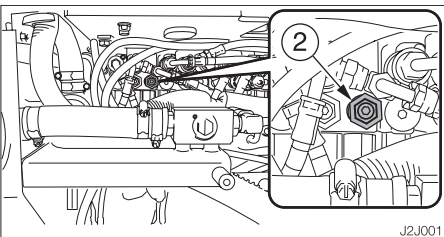

2. Put mark (M) on the plug of the port relief valve (2) and set screw (3).
3. Gripping the set screw (3) with a hexagonal wrench so that it does not turn together with the lock nut (4), loosen the lock nut (4).
4. Turn the set screw (3) slowly 1 and 1/3 turns to lower the boom. < TB153FR > Turn the set screw (3) slowly 1 turn to lower the boom. < TB180FR >
5. Check for safety and machine stability.
6. Turn the set screw (3) back to its original position.



7. Gripping the set screw (3) with a hexagonal wrench so that it does not turn together with the lock nut (4), tighten the lock nut (4).
 - Tightening torque : 27 to 31 N·m
(20 to 23 ft·lb.)
8. Reinstall the cover (1).

**⚠ WARNING**

When towing, selecting the wrong wire rope, inspecting improperly, or towing in the wrong way could lead to accidents resulting in serious injury or death.

- The wire rope breaking or coming detached could be extremely dangerous. Use a wire rope suited for the required towing force.
- Do not use a wire rope that is kinked, twisted or otherwise damaged.
- Do not apply strong loads abruptly to the wire rope.
- Use safety gloves when handling the wire rope.
- Make sure there is an operator on the machine being towed as well as on the machine that is towing.
- Never tow on slopes.
- Do not let anyone near the wire rope while towing.

Towing the Machine

Use the procedure described below to tow heavy objects or the machine itself if it should get stuck in the mud and not be able to get out on its own.

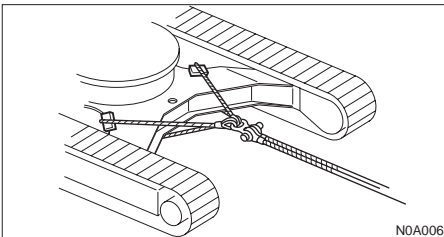

1. Fasten the wire rope to the frame.
2. Place splints or other objects between the wire rope and frame to prevent the machine and wire rope from getting damaged.
3. Move the machine to tauten the wire rope.
4. Move the machine slowly and tow.

Using the light load towing hole

IMPORTANT: Be sure to follow all the steps below closely when using the light load towing hole to tow. Failure to heed even one of the steps may cause damage to the light load towing hole or other parts of the frame.

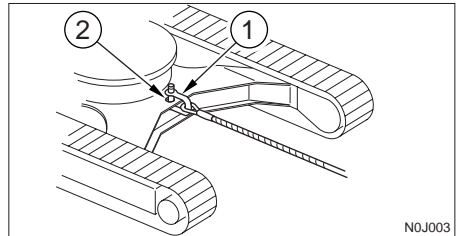

- Maximum pulling force :
 - < TB153FR > 27500 N (6170 lb) or less
 - < TB180FR > 43200 N (9700 lb) or less
1. Attach the wire rope to the shackle (1).
 2. Fasten the shackle (1) to the light load towing hole (2).
 3. Attach the wire rope to the object to be towed.
 4. Make the wire rope horizontal and line up straight with the travel frame.
 5. Move the machine to tauten the wire rope.
 6. Move the machine slowly and tow.



SPECIFICATIONS

Main Specifications	176
Machine Dimensions	178
Operating Range	180
Lifting Capacities	183



TB153FR

TYPE		CANOPY	CAB
MASS			
Machine mass kg (lb.) (not including operator)	Rubber crawlers	5505 (12135) {5540 (12215)}	5615 (12375) {5645 (12445)}
	Steel crawlers	5575 (12285) {5605 (12355)}	5680 (12525) {5715 (12600)}
PERFORMANCE			
Bucket capacity m ³ (cu.ft.) (standard bucket)	Heaped		0.141 (4.98)
	Struck		0.102 (3.60)
Slew speed min ⁻¹ (rpm)		9.8 (9.8)	
Travel speed km/h (mph)	Rubber crawlers	1st	2.8 (1.74)
		2nd	5.0 (3.11)
	Steel crawlers	1st	2.5 (1.55)
		2nd	4.7 (2.92)
Gradeability (degrees)		30	
Ground pressure kPa (psi)	Rubber crawlers	31.6 (4.58) {31.8 (4.61)}	32.2 (4.67) {32.4 (4.69)}
	Steel crawlers	32.0 (4.64) {32.2 (4.67)}	32.6 (4.72) {32.8 (4.75)}
Noise level dB(A)	Sound-power level		L _{WA} 96
	Sound-pressure level		L _{pA} 76
ENGINE			
Manufacturer and model		Yanmar 4TNV88-PTBZ1	
Rated output	kW / min ⁻¹ (hp / rpm)	28.9 / 2400 (38.7 / 2400)	
Displacement	ml (cu.in.)	2189 (133.6)	
Starter	V – kW	12 – 2.3	
Alternator	V – kW	12 – 0.48	
Battery	V – Ah	12 – 72	

{ } : Long Arm



TB180FR

TYPE		Standard Arm	Long Arm
MASS			
Machine mass kg (lb.) (not including operator)	Rubber crawlers	8325 (18355)	8350 (18410)
	Steel crawlers	8530 (18810)	8555 (18865)
PERFORMANCE			
Bucket capacity m ³ (cu.ft.) (standard bucket)	Heaped	0.245 (8.65)	
	Struck	0.165 (5.83)	
Slew speed min ⁻¹ (rpm)		9.9 (9.9)	
Travel speed km/h (mph)	Rubber crawlers	1st	2.7 (1.68)
		2nd	5.4 (3.36)
	Steel crawlers	1st	2.5 (1.55)
		2nd	5.0 (3.11)
Gradeability (degrees)		30	
Ground pressure kPa (psi)	Rubber crawlers	37.6 (5.45)	37.7 (5.46)
	Steel crawlers	38.5 (5.59)	38.6 (5.60)
Noise level dB(A)	Sound-power level	L _{WA} 98	
	Sound-pressure level	L _{pA} 76	
ENGINE			
Manufacturer and model		Yanmar 4TNV98-STB1	
Rated output	kW / min ⁻¹ (hp / rpm)	45.1 / 2200 (60.6 / 2200)	
Displacement	ml (cu.in.)	3319 (202.5)	
Starter	V – kW	12 – 3.0	
Alternator	V – kW	12 – 0.66	
Battery	V – Ah	12 – 72	

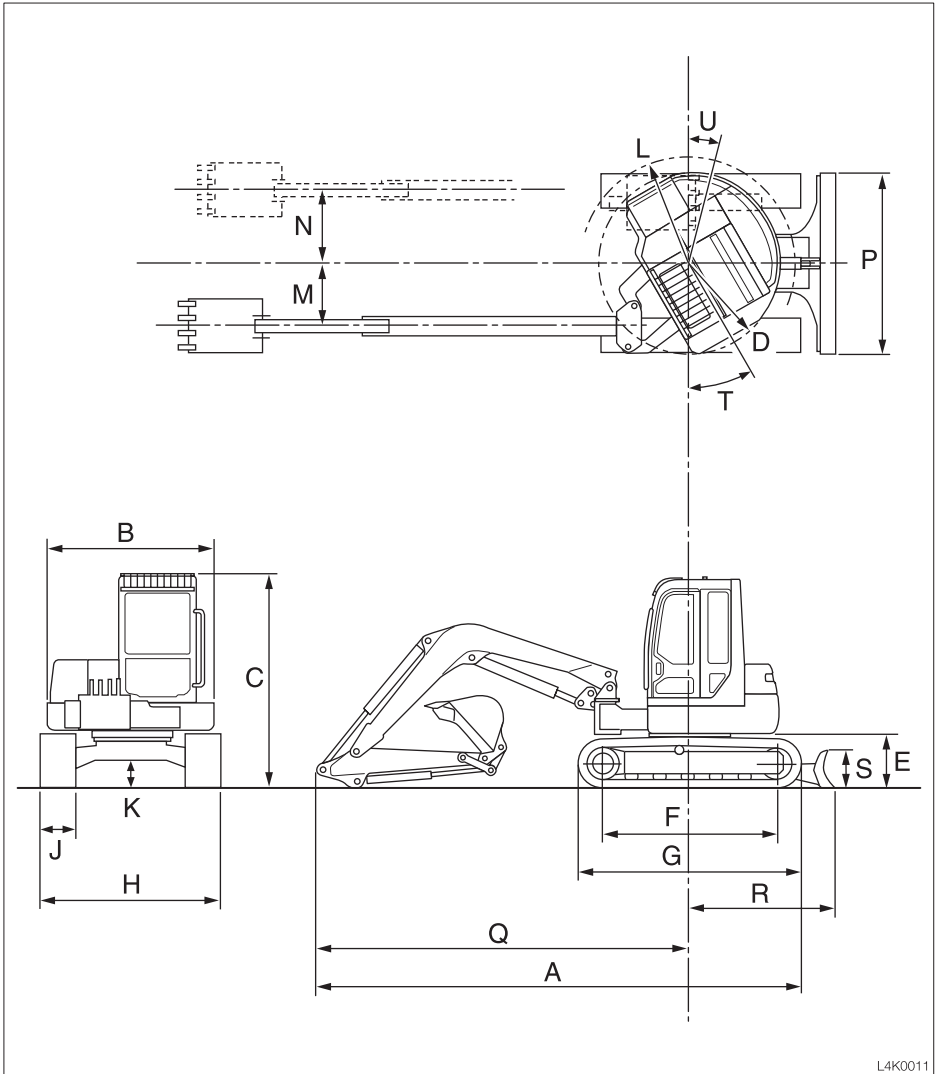

L4K0011



Units: mm (inches)

	TB153FR		TB180FR	
	Standard Arm	Long Arm	Standard Arm	Long Arm
Rubber Crawlers				
A	5330 (209.8)	5350 (210.6)	6150 (242)	6175 (243.1)
B	1860 (73.2)	←	2140 (84.3)	←
C	2570 (101.3) {2585 (101.7)}	←	2765 (108.9)	←
D	1110 (43.7)	←	1255 (49.4)	←
E	615 (24.2)	←	720 (28.3)	←
F	1985 (78.1)	←	2210 (87)	←
G	2500 (98.5)	←	2855 (112.4)	←
H	2000 (78.7)	←	2300 (90.6)	←
J	400 (15.7)	←	450 (17.7)	←
K	300 (11.8)	←	345 (13.5)	←
L	1285 (50.6)	←	1395 (55)	←
M	720 (28.3)	←	800 (31.4)	←
N	825 (32.4)	←	945 (37.2)	←
P	2000 (78.7)	←	2300 (90.6)	←
Q	4085 (160.8)	4105 (161.6)	4745 (186.8)	4775 (187.9)
R	1510 (59.4)	←	1855 (73.1)	←
S	430 (16.8)	←	500 (19.7)	←
T	30°		←	
U	15°		←	

{ } : Canopy

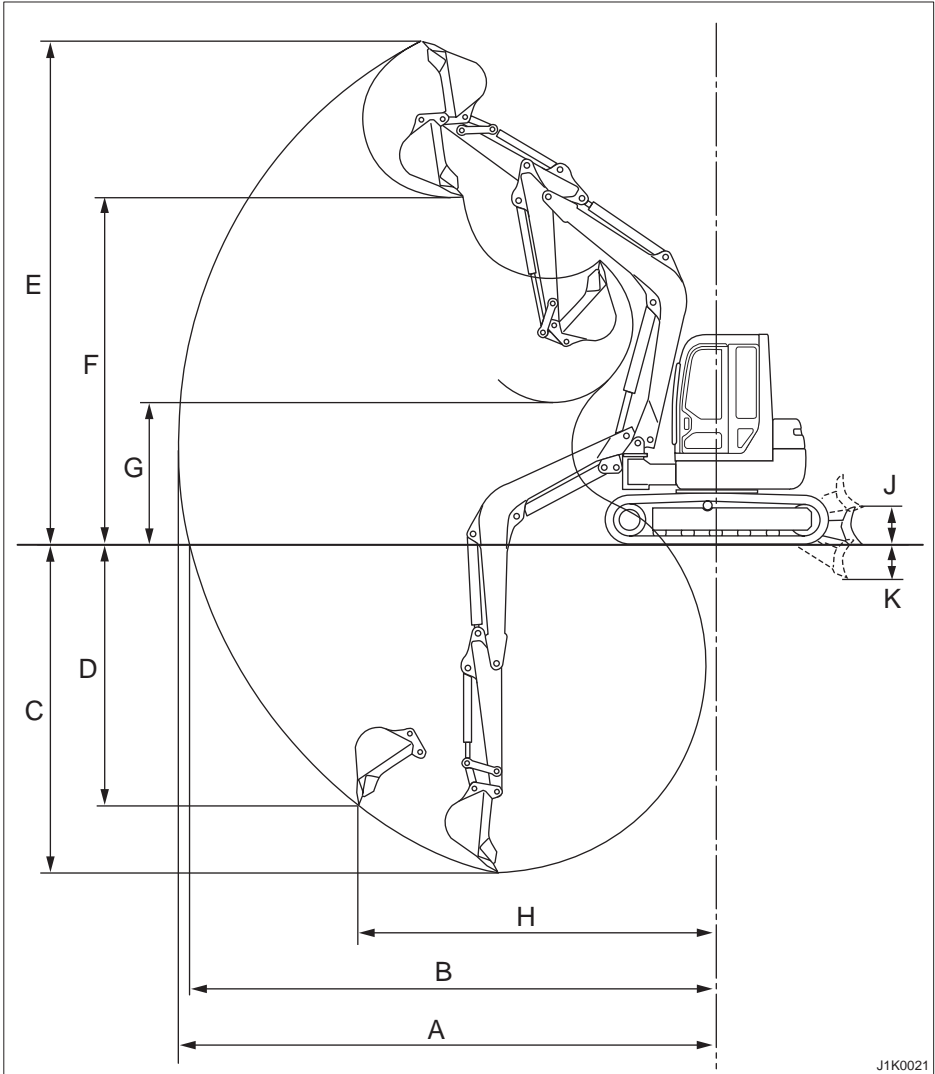

**TB153FR**

Units: mm (inches)

Item		Standard Arm	Long Arm
		Rubber Crawlers	
A	Max. digging radius	5905 (232.4)	6195 (243.9)
B	Max. ground digging radius	5765 (227.0)	6065 (238.7)
C	Max. digging depth	3590 (141.3)	3900 (153.5)
D	Max. vertical digging depth	2735 (107.7)	3030 (119.2)
E	Max. digging height	5320 (209.4)	5490 (216.2)
F	Max. dumping height	3710 (146.1)	3885 (152.9)
G	Min. dumping height	1435 (56.5)	1125 (44.3)
H	Max. vertical digging radius	3885 (153.0)	4075 (160.4)
J	Max. raising height	320 (12.6)	←
K	Max. lowering depth	325 (12.8)	←

TB180FR

Units: mm (inches)

Item		Standard Arm	Long Arm
		Rubber Crawlers	
A	Max. digging radius	6870 (270.5)	7195 (283.2)
B	Max. ground digging radius	6715 (264.3)	7045 (277.4)
C	Max. digging depth	4195 (165.2)	4545 (179.0)
D	Max. vertical digging depth	3165 (124.6)	3495 (137.6)
E	Max. digging height	6280 (247.2)	6460 (254.4)
F	Max. dumping height	4295 (169.1)	4475 (176.3)
G	Min. dumping height	1755 (69)	1405 (55.2)
H	Max. vertical digging radius	4700 (185.1)	4795 (188.8)
J	Max. raising height	505 (19.9)	←
K	Max. lowering depth	410 (16.1)	←

MEMO

**Rated lift capacity chart**

- The loads in the charts do not exceed 87% of hydraulic lift capacity or 75% of tipping load.
- Rated lift capacities limited by rated hydraulic lift capacity are identified by an asterisk(*).
- The mass of slings and any auxiliary lifting devices shall be deducted from the rated load to determine the net load that may be lifted.
- The load point is the bucket hinge pin, and the bucket posture is with the standard bucket completely retracted under the arm.
- Units: daN (lbs.)

Load hooking system

A load hooking system with all of the following capacities must be provided and used.

1. A system which can withstand a weight of two times the rated lift capacity no matter at what position the load is applied.
2. A system in which there is no risk of the lifted load falling from the hooking device, for example one equipped with a hook slippage prevention device.
3. A system in which there is no risk of the hooking system slipping from the hoe attachment.

 **WARNING**

- **DO NOT attempt to lift or hold any load that is greater than these rated values at their specified load radii and height.**
 - **All rated lift capacities are based on the machine being level and on a firm supporting surface. For safe working loads, the user is expected to make due allowance for the particular job conditions such as soft or uneven ground, non-level condition, side loads, hazardous conditions, experience of personnel, etc. The operator and other personnel should fully acquaint themselves with the operator's manual furnished by the manufacturer before operating this machine, and rules for safe operation of equipment shall be adhered to at all times.**
-



SPECIFICATIONS
Lifting Capacities

TB153FR Equipped with Standard Arm

Over Front ; Dozer Blade Up

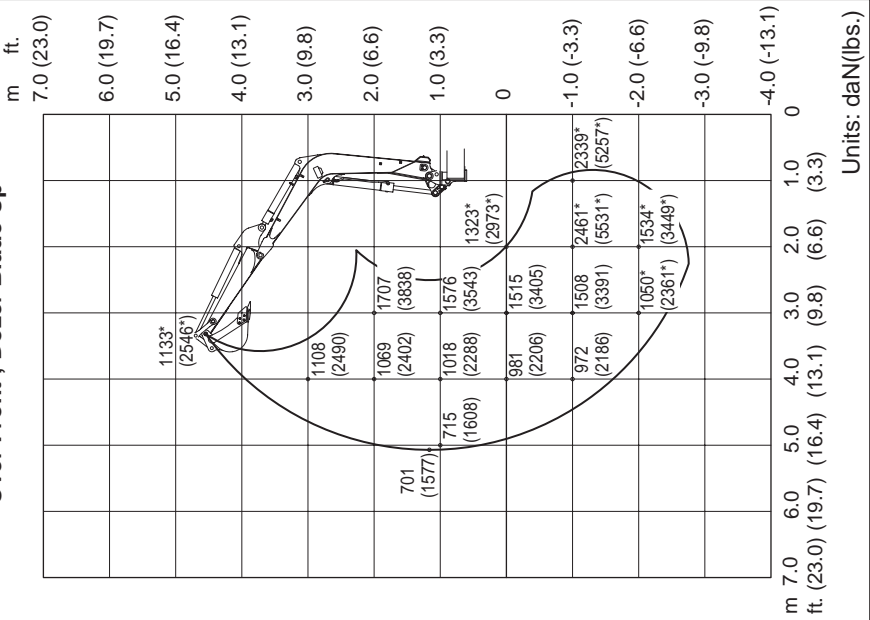



TB153FR Equipped with Standard Arm

Over Side

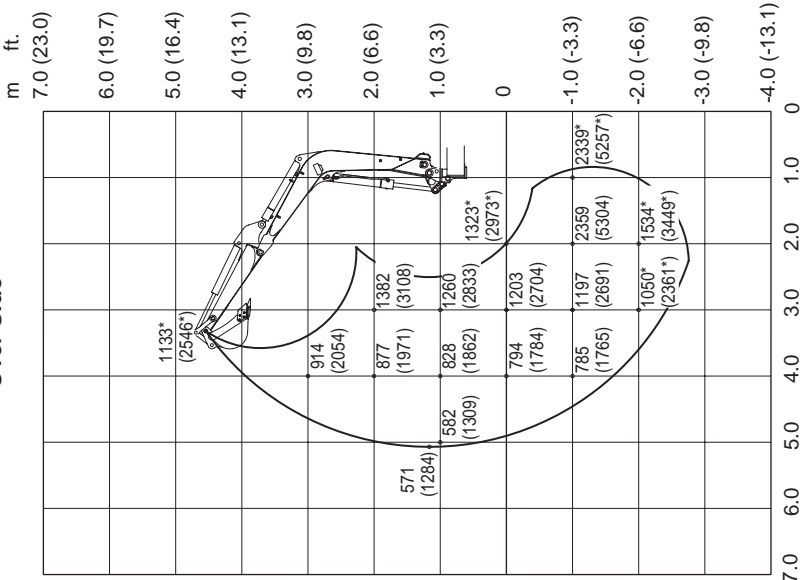

Over Rear

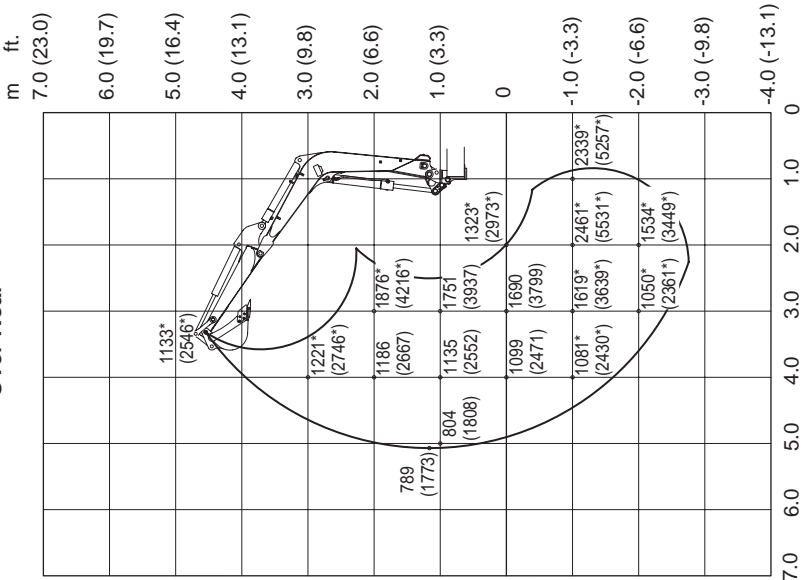

Units: daN(lbs.)



TB180FR Equipped with Standard Arm

Over Front ; Dozer Blade Up

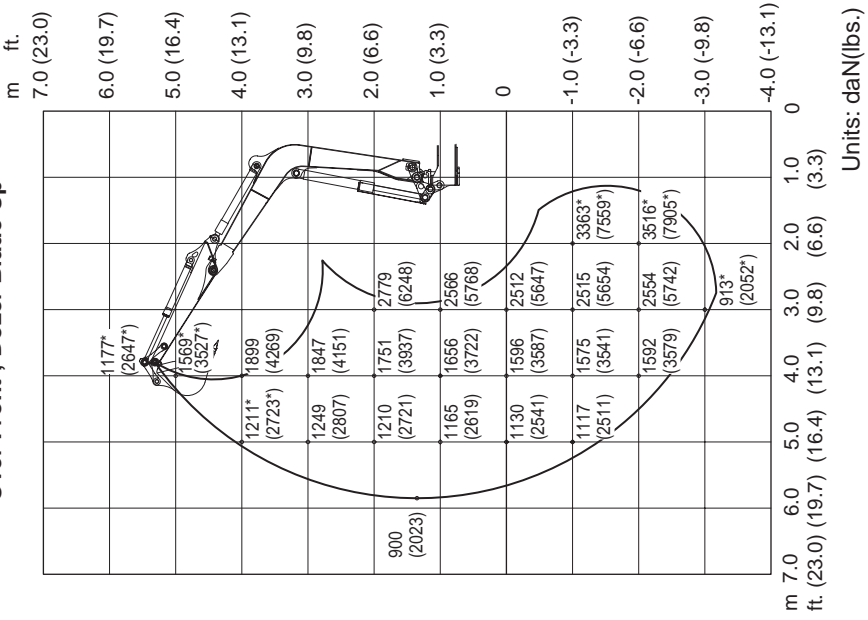



TB153FR Equipped with Long Arm

Over Front ; Dozer Blade Up

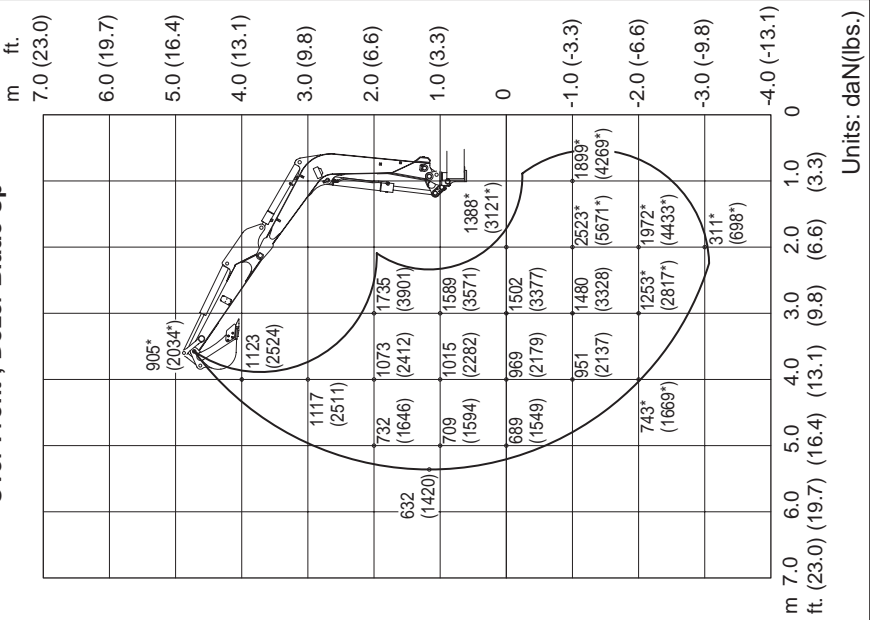



SPECIFICATIONS
Lifting Capacities

TB153FR Equipped with Long Arm

Over Side

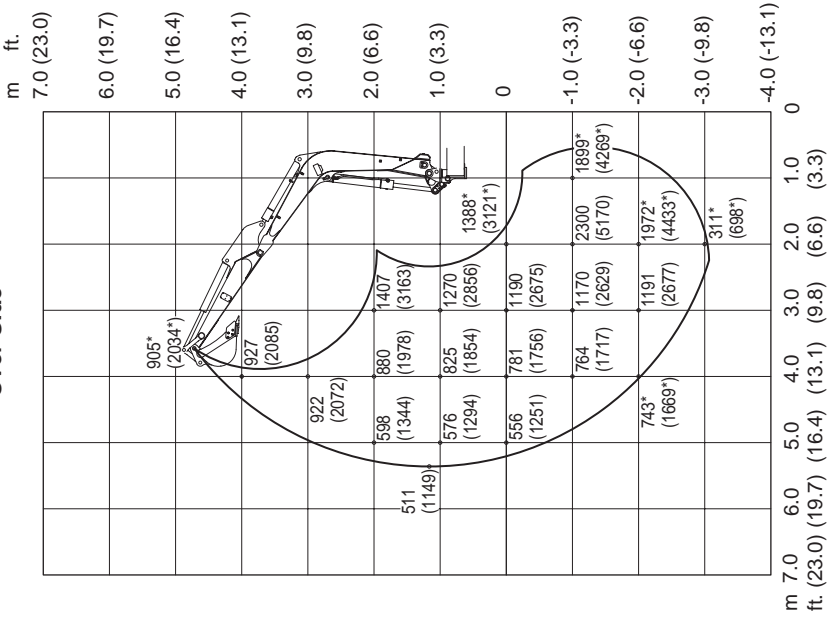

Over Rear

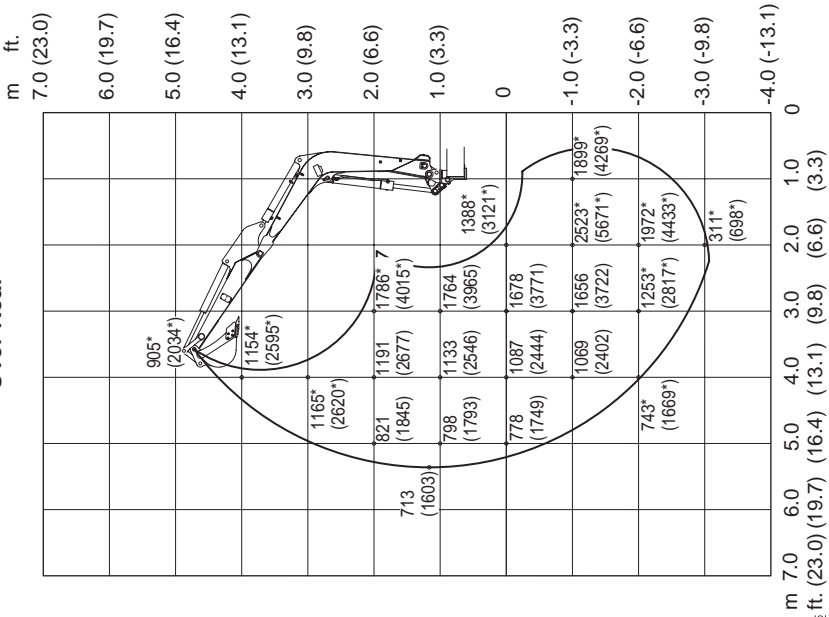

Units: daN(lbs.)

J2K004E



TB180FR Equipped with Long Arm

Over Front ; Dozer Blade Up

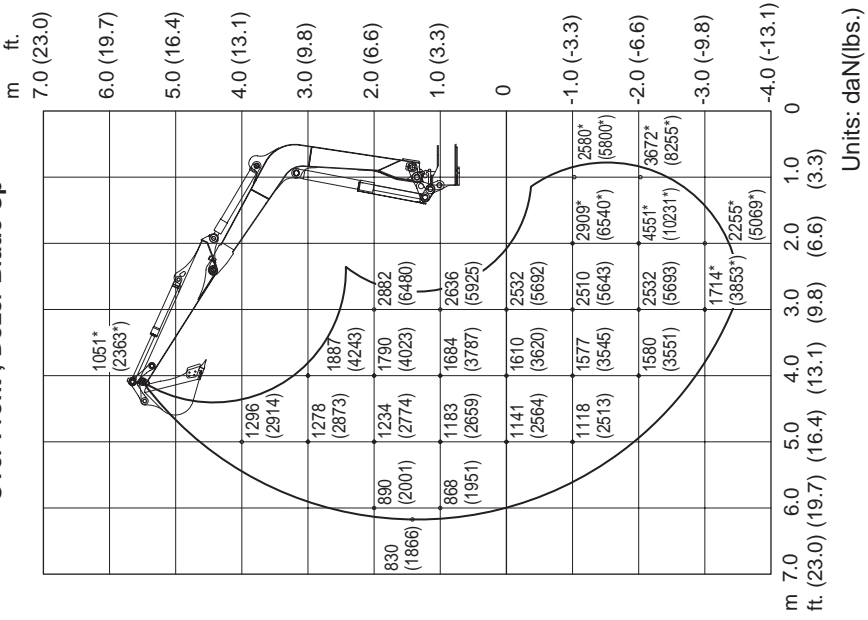

Units: daN(lbs.)



SPECIFICATIONS
Lifting Capacities

TB180FR Equipped with Long Arm

Over Side

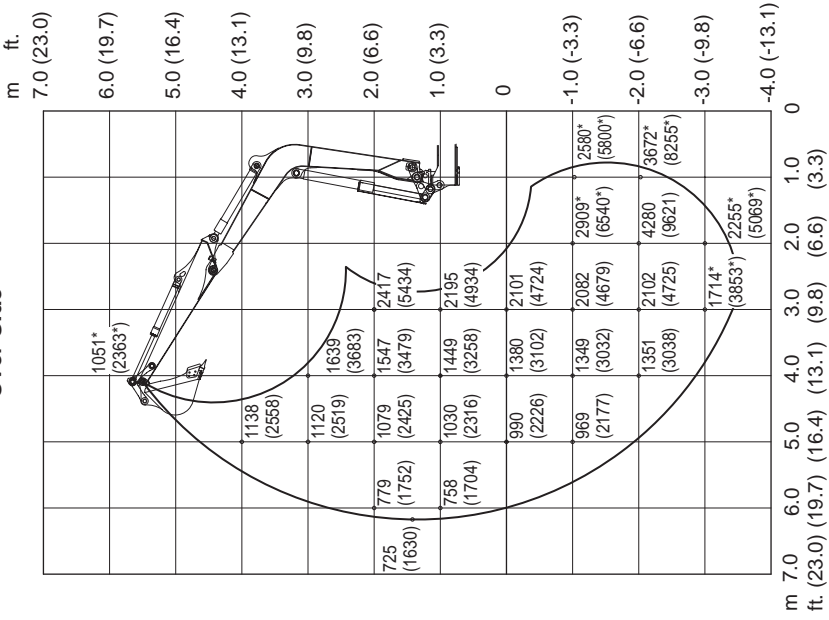

Over Rear

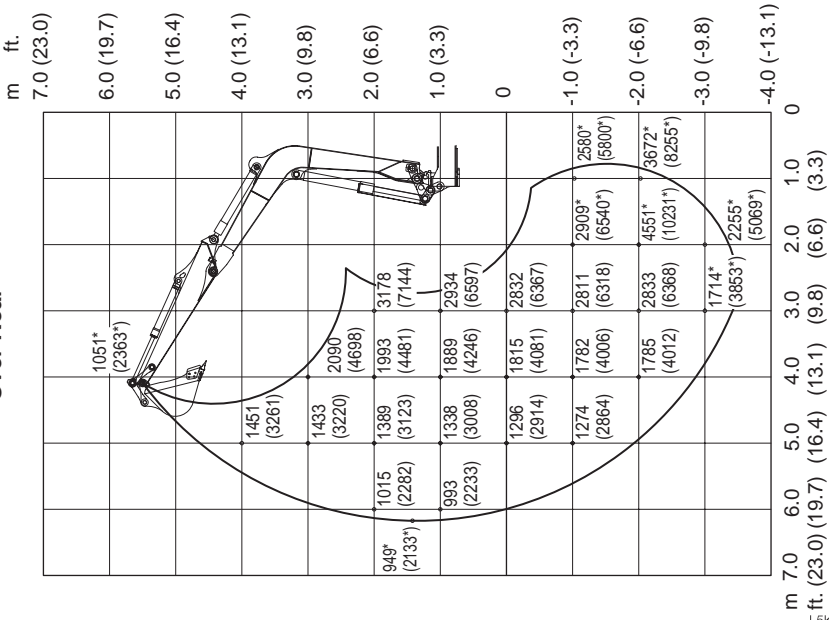

Units: daN(lbs.)

L5K004E



OPTIONS

General Precautions	194
Safety Signs (Decals)	196
Switching the Lever Pattern	198
3-Hole Bucket < TB180FR >	199
Hydraulic Breaker	200
Load Safety Device	202
Accumulator	204
Pre Cleaner < TB180FR >	205
Second Auxiliary Hydraulics	206
Third Auxiliary Hydraulics	208
Fourth Auxiliary Hydraulics < TB180FR > ..	210
Travel Alarm	212
Fuel Supply Pump < TB180FR >	213
Air Conditioner	214
Immobilizer System	224



Precautions on Safety

WARNING

Heed the following when removing or installing an attachment or option:

- Consult with a Takeuchi dealer before installing optional attachments.
- Do not use attachments that have not been approved by Takeuchi or a Takeuchi dealer. Doing so may compromise safety or adversely affect the machine's operation or service life.
- Takeuchi will not be held responsible for any injuries, accidents or damage to products caused by the use of a non-approved attachment.
- Choose a flat, hard surface to perform the operations. Also make sure there is enough light and good ventilation.
- Clean the area, remove any articles that may get in the way or be dangerous, and remove any spilled oil or grease.
- When performing lifting operations, determine a person to lead the operations and always follow that person's instructions.
 - Follow the leader's instructions on operating methods and procedures.
 - Determine a signal leader and heed this person's signals.
- When removing or installing the hoe attachment, place it in a stable position so that it does not tip over.
- Due to the risk of loads falling and / or hitting people, do not allow unauthorized personnel in the work area.
- Use the crane to carry heavy objects (25 kg (55 lb.) or greater).
- When removing heavy parts, be sure to prop them up before removing them. When lifting them with a crane, be careful to balance them properly.
- Operating with loads suspended with the crane is dangerous. Place loads on a stand and check for safety.
- When attaching the boom or arm, failure to follow proper procedures could result in serious damage. Consult with a Takeuchi dealer beforehand.

Precautions on Installing Attachments

After replacing optional attachments or other special attachments, test-run them, then inspect the hydraulic oil level and add oil if necessary.

In addition, consult with a Takeuchi dealer for details of removal and installation procedures.



Keep all safety signs clean and legible.

Replace all missing, illegible or damaged safety and warning signs.

There are other safety signs in addition to the ones listed here. Treat them in the same way.

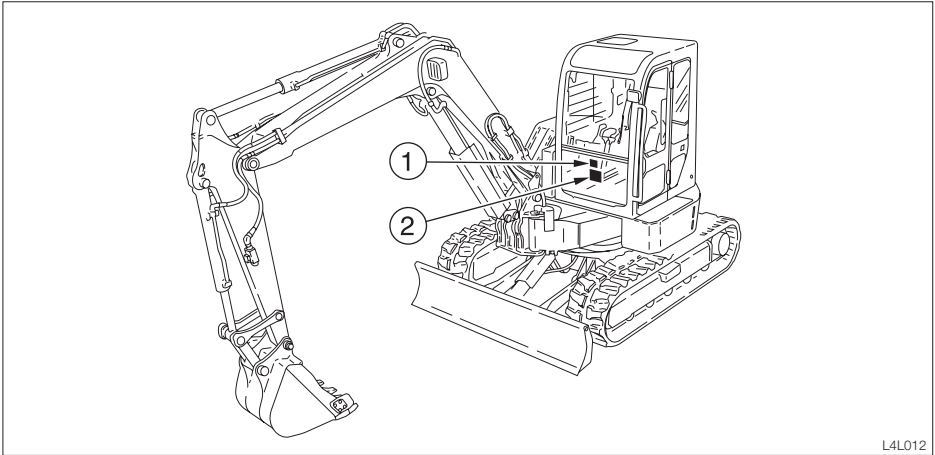

L4L012



OPTIONS

Safety Signs (Decals)

1. No.03593-32200

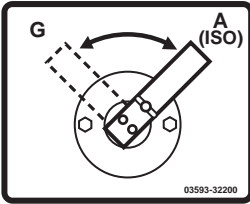

2. No.03593-32300





Switching the Lever Pattern

The operating pattern of the left and right operating levers can be changed.

WARNING

Before starting the engine, check the selector to see which operating pattern the left and right operating levers are set for.

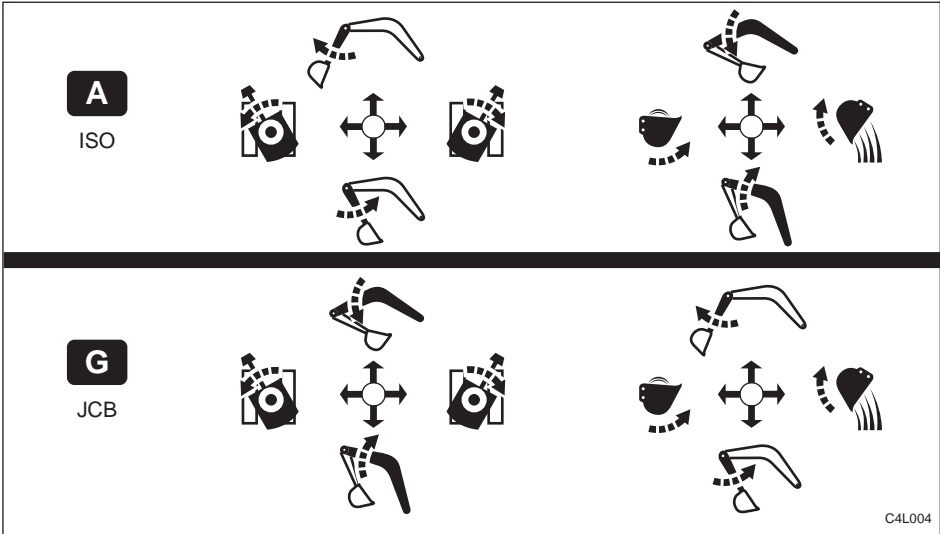

C4L004

Switching the Lever Pattern

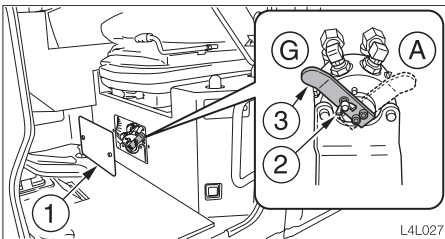

L4L027

(A) : ISO pattern
(G) : JCB pattern

1. Park the machine in a safe place and turn off the engine.
2. Fully open the cab door and fix it in place.
3. Remove the cover (1).
4. Loosen the wing bolt (2).
5. Turn the selector valve lever (3) and switch the pattern.
6. Tighten the wing bolt (2) and fasten the lever (3) in place.
7. Close the cover (1).
8. Check the lever pattern.

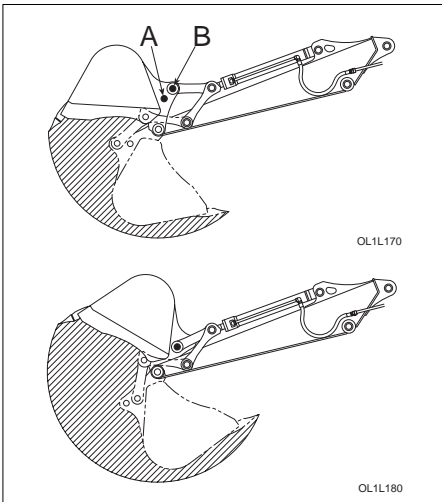

The digging capacity increases when the bucket's link arm installation position is switched from (A) to (B). However, this shortens the bucket stroke.

- Struck capacity (SAE) :
0.210 m³ (0.275 cu. yd.)
- Rated capacity (SAE) :
0.261 m³ (0.341 cu. yd.)

Changing the Link Arm Installation Position

Refer to page 148 "Replacing the Bucket" in the manual.



For handling of the breaker, read the hydraulic breaker's manual, provided separately.

IMPORTANT: When mounting devices, select devices suited for this machine. For advice on selecting device, contact a Takeuchi sales or service outlet.

Precautions on Operating

< TB153FR >

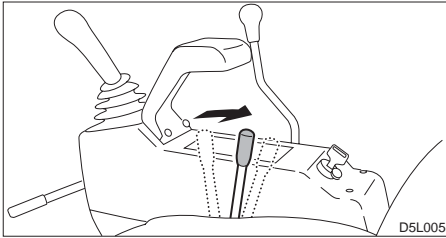

< TB180FR >

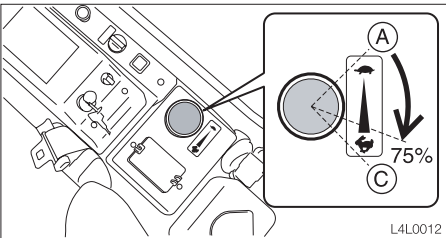

- Run the engine with 75% the maximum speed.

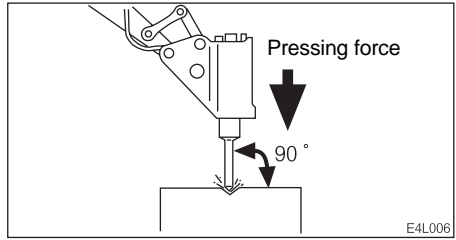

- Pound with the chisel perpendicular to the surface you are pounding.
- When pounding, press the chisel properly against the object to be broken so as to avoid pounding the air.

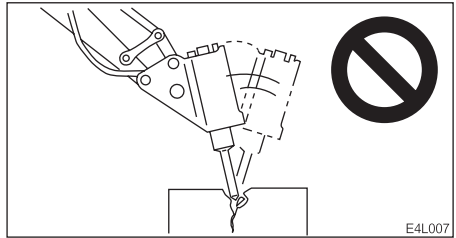

- Do not pry with the chisel, and do not pry while pounding.
- Do not move the chisel while pounding.
- Do not pound continuously for over 30 seconds on the same surface.

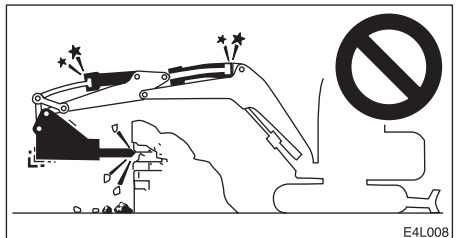

- Do not pound with the cylinder fully extended or contracted (at the stroke end). Leave a margin of at least 5 cm.

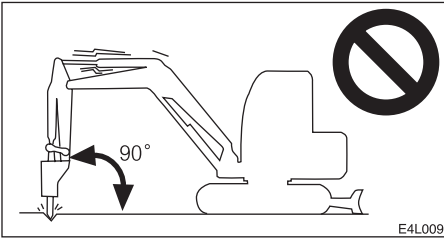

- Do not pound with the arm perpendicular to the ground surface.

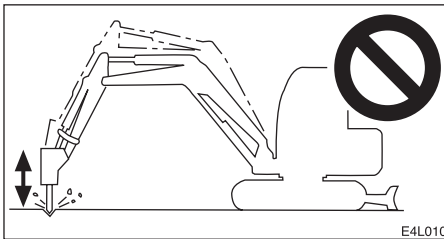

- Do not drop the breaker itself on the object to be broken in order to break it.
- Do not move objects to be broken or rocks with the breaker itself.
- Slew occasionally to cool the engine.
- If a hydraulic hose is vibrating abnormally, nitrogen gas may be leaking from the accumulator. Have an inspection as soon as possible.

Replace the Hydraulic Oil Regularly!

- When using a hydraulic breaker, the oil deteriorates quicker than during normal digging. Be sure to replace the hydraulic oil and return filter element.
- Failure to replace these in time can lead to damage to the machine and breaker's hydraulic systems. In order to improve the service life of the hydraulic systems, be sure to replace the hydraulic oil and return filter element according to the following chart of the replacement interval.
- Clean the suction strainer when changing the return filter element.

Replacement Interval (Hours)

Item	Hydraulic Oil	Filter Element
1st time	—	25
2nd time	—	100
Periodically	600	200

When the breaker operating ratio is 100%

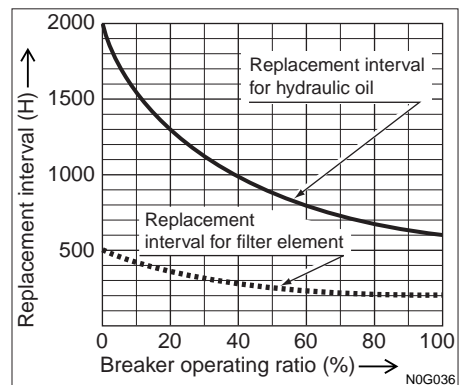



The load safety devices include an emergency shut-off valve and an overload warning device. The emergency shut-off valve stops the boom or arm part way through a fall. The overload warning device sounds an alarm when an excessive load is applied.

Emergency Shut-off Valve

When the hose of the boom or arm cylinders are ruptured and the boom or arm falls, the emergency shut-off valve is activated and stops the boom or arm part way through the fall.



WARNING

If the boom or arm drops and the emergency shut-off valves are activated, immediately move away from the suspended object.

Boom

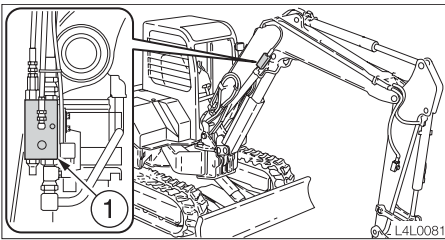

Arm

< TB153FR >

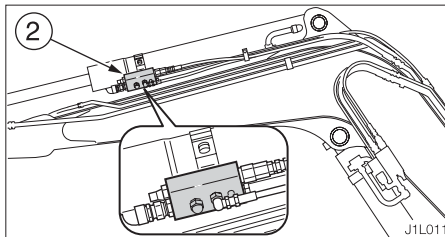

< TB180FR >

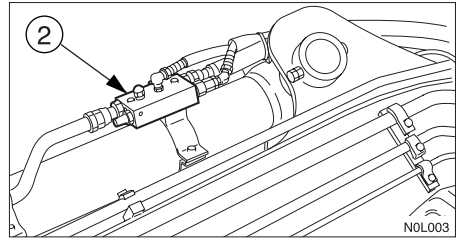

If the emergency shut-off valves (1) or (2) are activated, immediately set the operating lever to the neutral position. Do not move the operating lever to the boom or arm lowering side. Contact a Takeuchi dealer for maintenance.

If the engine can be started, the boom or arm can be lowered with the operating lever. Check for safety, then slowly lower the boom or arm.

If the engine cannot be started, the boom or arm can be lowered using the procedure described below.

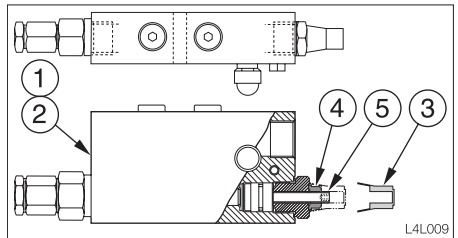

1. Check for safety in the working area and for stability of the machine and lifted load.
2. Remove the cap (3).
3. Loosen the lock nut (4).
4. Tighten the stem (5) to lower the boom or arm.
5. Check for stability of the hoe attachment and load.
6. Loosen the stem (5) secure it with the lock nut (4).



Overload Warning Device

If a weight greater than the machine is designed to lift is lifted, the overload warning device is activated and a horn is sounded (when the overload warning switch is turned on).

WARNING

Continuing to apply the load after the overload warning horn sounds could result in the machine tipping over or the emergency shut-off valve being activated. If the horn sounds, stop operating the machine and lighten the load.

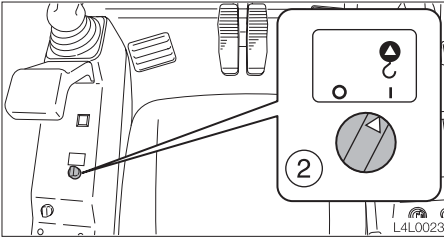

Overload warning switch (2)

- position OFF
- I position ON

When the emergency shut-off valve is activated, the overload warning horn stops. (This is because the pressure sensor can no longer detect hydraulic pressure.)



Operating the Machine with Accumulator

On machines equipped with an accumulator, the residual pressure in the auxiliary hydraulic circuits and the working equipment can be released within a specific amount of time (within 5 minutes) after the engine is stopped.

Releasing the residual pressure

After using the machine, pressure remains in the hydraulic circuits. This is called the residual pressure. Use the procedure below to release the residual pressure as necessary.

Perform the operation to release the residual pressure within 5 minutes after stopping the engine.

1. Press the decel. button and idle the engine at low speed.
2. Lower the bucket and dozer blade to the ground.
3. Check that the safety lock lever is in the released position.
4. Stop the engine.
5. Turn the starter switch to the ON position.

• First auxiliary hydraulics

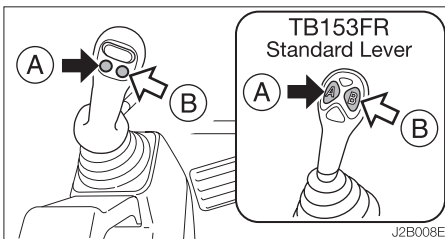

6. Press both the auxiliary hydraulic buttons (A) and (B) several times to release the residual pressure in the circuitry.

• Second and fourth auxiliary hydraulics

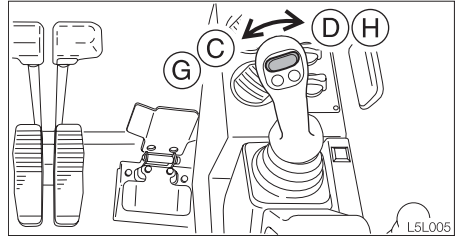

6. Move the second / fourth auxiliary hydraulic switch to the right and left several times.

When equipped with fourth auxiliary hydraulics. < TB180FR >

- a. Press the selector button (2nd or 4th Aux.) to change over to operation of the second auxiliary hydraulics.
 - b. Move the second / fourth auxiliary hydraulic switch to the right and left several times.
7. Move all the control levers and pedal several times in all directions to release the pressure from the working equipment circuitry.
 8. Raise the safety lock lever to engage the lock.

Lowering the boom when the engine has stopped.

Perform this operation within 5 minutes after stopping the engine.

1. Check that the safety lock lever is in the released position.
2. Check that the starter switch is in the ON position.
3. Push the operating lever slowly forward to lower the boom.



Inspecting and Cleaning the Pre Cleaner

WARNING

- Stop the engine and allow the machine to cool down before performing maintenance.
- The engine, muffler, radiator and many other parts of the machine are hot directly after the engine is stopped. Touching these parts will cause burns.
- Wear required appropriate equipment such as safety glasses and filter mask when using compressed air, as metal fragments or other objects can fly and cause serious personal injury.

IMPORTANT: When operating the machine in very dusty places, inspection and maintenance should be performed every day.

IMPORTANT: If the air cleaner warning lamp flashes and an alarm is sounded during operation, stop the engine immediately and inspect and/or clean.

Inspection

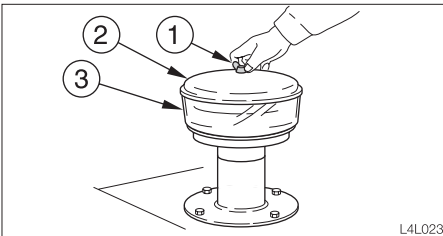

1. Inspect for any dirt or dust accumulated in the dust cup (3).
2. If dust has accumulated, clean the dust cup (3).

Cleaning

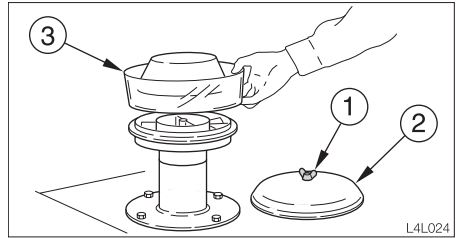

1. Loosen the wing nut (1) and remove the cover (2).
2. Remove the dust cup (3).
3. Clean the inside of the dust cup (3).
4. Install the dust cup (3) and cover (2) and tighten the wing nut (1).

**Second Auxiliary Hydraulic Lines****⚠ WARNING**

Oil may spurt out if caps or filters are removed or pipes disconnected before releasing the pressure in the hydraulic system.

- When disconnecting hoses, release the internal pressure before removing.

These lines deliver the hydraulic oil necessary for operating a hydraulic attachment.

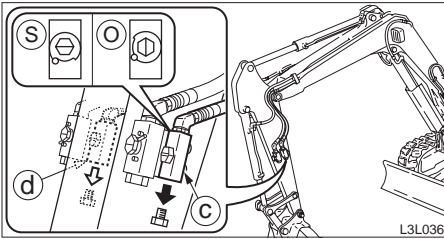

Stop valve (S): Closed (O): Open

Connecting the Hydraulic Circuits

To connect the attachment hydraulic lines, use the following procedures :

1. Release the pressure remaining in the lines then close the stop valve.
When equipped with accumulator :
Refer to page 204 "Releasing the residual pressure".
2. Remove the plugs.
3. Connect the attachment hydraulic lines to ports (c) and (d).
4. Open the stop valves.
5. When connecting is complete, purge air from the hydraulic lines.
 - a. Start and run the engine at low idle with no load for 10 minutes.

- b. With the engine running at low idle operate the auxiliary hydraulic switches repeatedly (approx. 10 times) to purge air from the hydraulic lines.
- c. Stop the engine and wait for more than 5 minutes until bubbles escape from the hydraulic oil in the tank.

IMPORTANT: Follow the procedures for purging air as instructed by the attachment manufacturer if specified to do so.

6. Check for leaks.



Second Auxiliary Hydraulic Switch

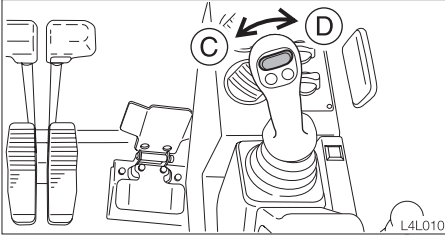

Move this switch to control the flow of the oil in the second auxiliary hydraulic lines.

- (C) Hydraulic oil flows to left auxiliary line(c)
 - (D) Hydraulic oil flows to right auxiliary line(d)
- When the safety lock lever is set to the lock position, this control is locked.

Disconnecting the hydraulic circuits

1. Release the pressure remaining in the lines then close the stop valve.
When equipped with accumulator :
Refer to page 204 "Releasing the residual pressure".
2. Disconnect the lines from ports (c) and (d).
3. Install the plugs.

**Third Auxiliary Hydraulic Lines****⚠ WARNING**

Oil may spurt out if caps or filters are removed or pipes disconnected before releasing the pressure in the hydraulic system.

- When disconnecting hoses, release the internal pressure before removing.

These lines deliver the hydraulic oil necessary for operating a quick attachment.

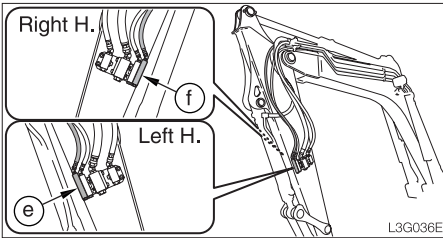
**Connecting the Hydraulic Circuits**

To connect the attachment hydraulic lines, use the following procedures :

1. Release the pressure remaining in the lines.
Refer to “Releasing the residual pressure”.
2. Remove the plugs.
3. Connect the attachment hydraulic lines to ports (e) and (f).
4. When connecting is complete, purge air from the hydraulic lines.
 - a. Start and run the engine at low idle with no load for 10 minutes.
 - b. With the engine running at low idle operate the auxiliary hydraulic switches repeatedly (approx. 10 times) to purge air from the hydraulic lines.
 - c. Stop the engine and wait for more than 5 minutes until bubbles escape from the hydraulic oil in the tank.

IMPORTANT: Follow the procedures for purging air as instructed by the attachment manufacturer if specified to do so.

5. Check for leaks.

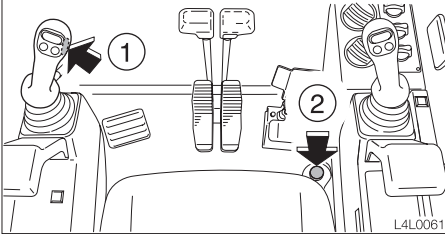
**Third Auxiliary Hydraulic Switch and Button**

Press those switch and button to control the flow of the oil in the third auxiliary hydraulic lines.

When the safety lock lever is released after the engine is started, hydraulic oil constantly flows in pipe (e). When button (1) and switch (2) are pressed simultaneously, the oil flow switches to pipe (f). When this happens, the pressure of pipe (e) drops, an alarm is sounded and the warning lamp lights. For safety, only operates when both button (1) and switch (2) are pressed.

Disconnecting the hydraulic circuits

1. Release the pressure remaining in the lines.
Refer to "Releasing the residual pressure".
2. Disconnect the lines from ports (e) and (f).
3. Install the plugs.

Releasing the residual pressure

After using the auxiliary hydraulic circuits, pressure remains in the circuits. This is called the residual pressure. Release this residual pressure before disconnecting the lines.

1. Stop the engine.
(The residual pressure is released from the (e) port line.)

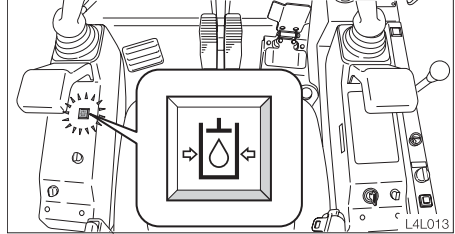
Third Auxiliary Hydraulics Warning Lamp

This lamp illuminates and an alarm sounds when the third auxiliary hydraulic pressure drops abnormally, when the safety lock lever is fully lowered to the unlocked position while the engine is running.

**Fourth Auxiliary Hydraulic Lines****⚠ WARNING**

Oil may spurt out if caps or filters are removed or pipes disconnected before releasing the pressure in the hydraulic system.

- When disconnecting hoses, release the internal pressure before removing.

These lines deliver the hydraulic oil necessary for operating a hydraulic attachment.

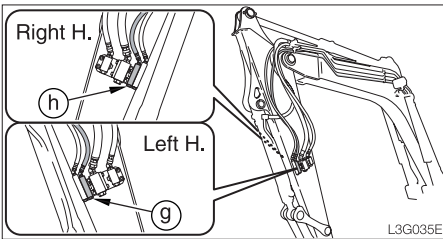
**Connecting the Hydraulic Circuits**

To connect the attachment hydraulic lines, use the following procedures :

1. Release the pressure remaining in the lines.
When equipped with accumulator :
Refer to page 204 "Releasing the residual pressure".
2. Remove the plugs.
3. Connect the attachment hydraulic lines to ports (g) and (h).
4. When connecting is complete, purge air from the hydraulic lines.
 - a. Start and run the engine at low idle with no load for 10 minutes.
 - b. With the engine running at low idle operate the auxiliary hydraulic switches repeatedly (approx. 10 times) to purge air from the hydraulic lines.

- c. Stop the engine and wait for more than 5 minutes until bubbles escape from the hydraulic oil in the tank.

IMPORTANT: Follow the procedures for purging air as instructed by the attachment manufacturer if specified to do so.

5. Check for leaks.

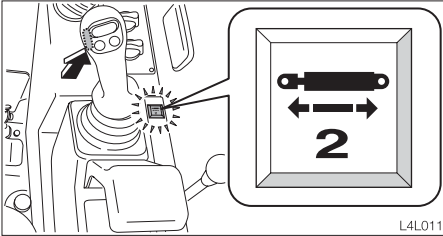
**Selector Button (2nd or 4th Aux.)**

This button changes from the fourth auxiliary hydraulics operation to the second auxiliary hydraulics operation.

Press this button to change over to operation of the second auxiliary hydraulics. The second auxiliary hydraulics operation indicator lamp will light. One more press of this button will result in a return to fourth auxiliary hydraulics operation. Actual operation is performed with the second / fourth auxiliary hydraulic switch (slider switch).

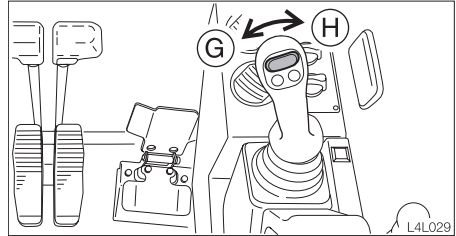
Second / Fourth Auxiliary Hydraulic Switch

Move this switch to control the flow of the oil in the fourth auxiliary hydraulic lines.

- (G) Hydraulic oil flows to left auxiliary line(g)
- (H) Hydraulic oil flows to right auxiliary line(h)

- When the safety lock lever is set to the lock position, this control is locked.

Disconnecting the hydraulic circuits

1. Release the pressure remaining in the lines.
When equipped with accumulator :
Refer to page 204 "Releasing the residual pressure".
2. Disconnect the lines from ports (g) and (h).
3. Install the plugs.



An alarm is sounded when the machine travels and stops when traveling is stopped. If the alarm does not sound when the machine travels, the fuse may be blown. Inspect the fuse.

⚠ WARNING

If the fuse which has just been replaced should blow again, there is a problem in the electrical system. This could cause fires. Contact a Takeuchi dealer.

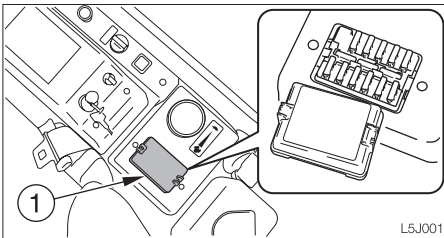

L5J001

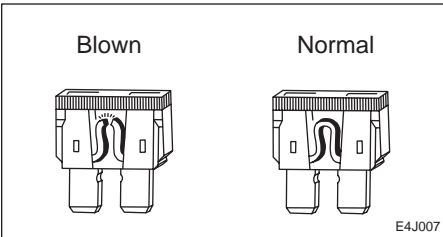

E4J007

1. Park the machine in a safe place.
2. Set the starter switch to OFF.
3. Open the fuse box cover (1).
4. Inspect for blown fuse.
5. If a fuse is blown, replace it with a spare fuse of the same capacity.

Fuse Layout and Circuits Protected
< TB153FR >

Capacity	Protected circuit	Capacity	Protected circuit
20A	Horn		
10A	Radio, Interior light	10A	Controller
10A	Lever lock	30A	Stop solenoid
30A	Lights	5A	Controller (ACC), Accessory relay
30A	Wiper, Cigarette lighter	5A	Instrument cluster Feed pump
10A	Optional Travel alarm	5A	Interference prevention

< TB180FR >

Capacity	Protected circuit	Capacity	Protected circuit
20A	Horn		
10A	Radio, Interior light	10A	Throttle controller
10A	Lever lock	30A	Emergency stop relay
5A	Lights	5A	Controller (ACC), Accessory relay
30A	Wiper, Cigarette lighter	5A	Instrument cluster
10A	Optional Travel alarm	5A	Interference prevention



This device automatically supplies fuel to the fuel tank and stops automatically when the fuel tank is full.



Do not use the fuel supply pump for gasoline or hydraulic oil. Doing so could result in explosion or damage. Only use the fuel supply pump for diesel fuel.

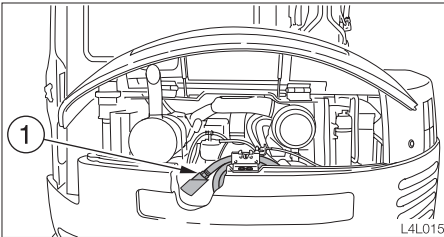

1. Open the engine hood.
2. Insert the pump's nozzle (1) in the fuel supply tank.

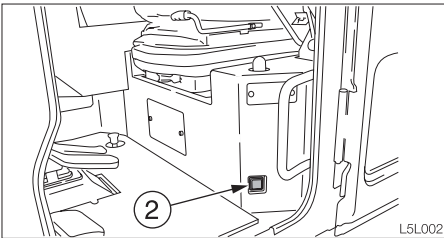

3. Open the cab door.
4. Press the switch (2).
The pump stops automatically once the fuel tank is full.



CAUTIONS ON USE

Ventilate periodically

- When using the air conditioner over an extended period of time, open the windows about once each hour to let in fresh air.
- Your eyes may become irritated if you smoke while using the air conditioner. If this happens, open the windows to let in fresh air. Cigarette smoke particularly irritates the eyes when using the air conditioner because the humidity in the cabin drops and the eyes' membranes tend to become dry.

Always maintain good visibility

Working with the windows dirty or fogged restricts visibility and is dangerous. Always clean dirt and moisture off the windows before working.

- The windows tends to get foggy when the humidity is high. If this happens, turn on the air conditioner and use outside air and the defroster to get rid of the fog.
- If the air conditioner is set to high when using the defroster, the difference between the external and internal temperatures increases, and fog may form on the outside of the windows. If this happens, either turn the air conditioner off or turn the temperature control dial clockwise to increase the internal temperature.
- Mist may blow out of the air outlets. This is not a malfunction. When moist air passes through the air conditioner unit's evaporator, water particles in the air freeze and are emitted as mist.

Do not overcool

For health purposes, the air inside the cab should be kept at a temperature at which you feel a little cool when entering the cab from outside (a difference of 5 to 6°C (9 to 11°F)). Be careful to adjust the temperature properly.

Do not turn the air conditioner on until the engine is started

To avoid placing an excessive load on the compressor, wait until the engine is started and is running smoothly before turning on the air conditioner.

Let hot air out first

If the excavator has been parked in the sun, open the windows or door to let the hot air out of the cab before using the air conditioner.

Caution on refrigerant (gas)

Exposure of the eyes or hands to the cooler's refrigerant could result in blindness or frostbite. Never touch the refrigerant or loosen the parts of the cooling circuit. Should the refrigerant gas leak, keep flames away.



NAMES OF COMPONENTS

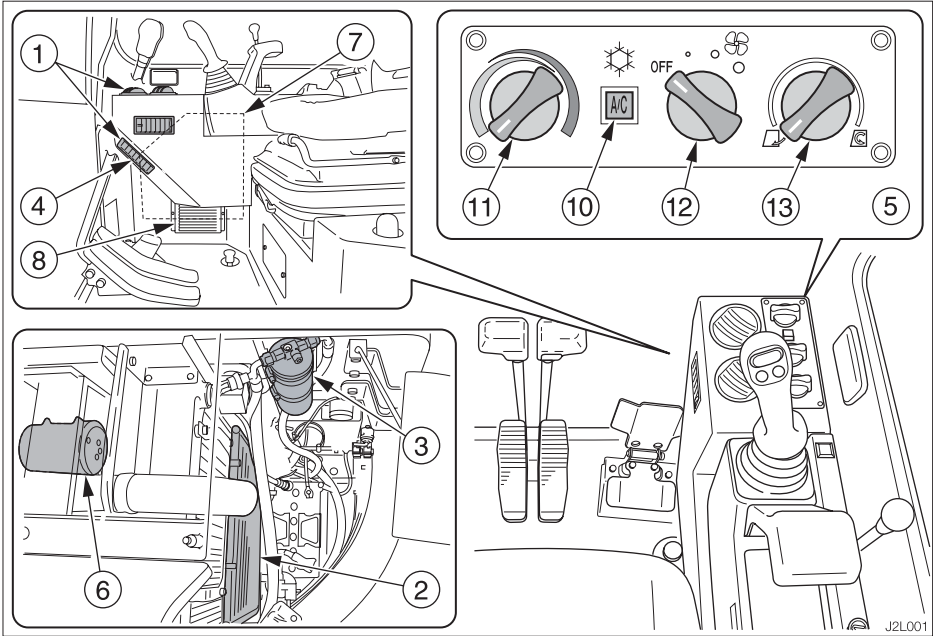

1. Defroster
2. Condenser
3. Receiver drier
4. Foot outlets
5. Control panel
6. Compressor
7. Air conditioner unit
8. Inner filter
9. Outer filter
10. Air conditioner switch
11. Temperature control dial
12. Fan switch
13. Airflow mode control dial

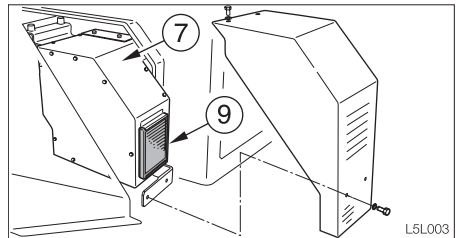



Air Conditioner Switch

IMPORTANT: To avoid placing an excessive load on the compressor, wait until the engine is started and is running smoothly before turning on the air conditioner.

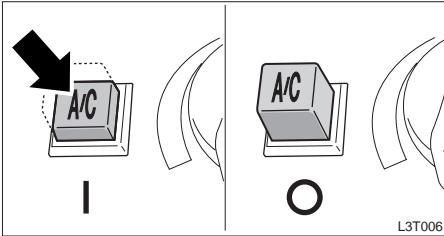

Use this switch to turn the air conditioner ON and OFF. When this switch is pressed while the engine is running and the fan switch is ON, the air conditioner turns on. Press the switch again or turn the fan switch OFF to stop the air conditioner.

- O OFF
- I ON

Supplement: To prevent leakage of coolant gas from the compressor's seal, operate the air conditioner at least once a week, regardless of the season.

Supplement: The air conditioner will not function if the temperature in the cab is low (about 3°C (38°F) or lower).

Temperature Control Dial

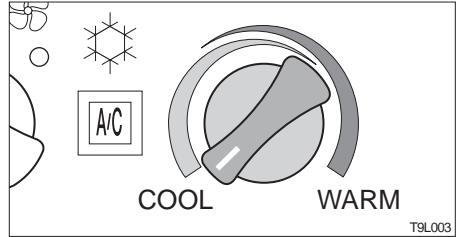

Use this dial to adjust the air temperature.

COOL To lower the temperature

WARM To increase the temperature

Supplement: No warm air is emitted if the temperature of the engine coolant is low.

Fan Switch

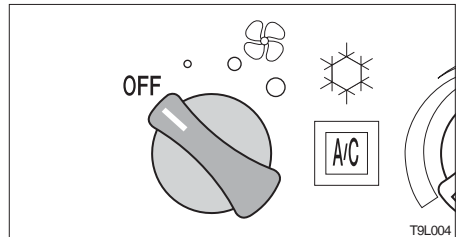

Use this switch to adjust the fan speed in three steps. At the OFF position, the air conditioner is also OFF.

OFF Fan and air conditioner off

- Low
- Medium
- High



Airflow Mode Control Dial

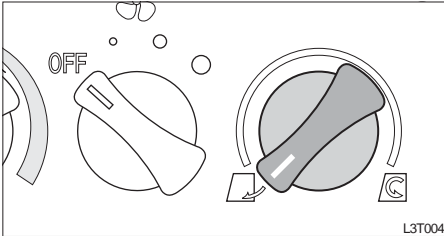

L3T004

Use this dial to select recirculation or fresh air intake.

..... Recirculation

- To cool or heat the cab quickly
- When external air is dirty

CENTER 50% fresh air intake

- To let in fresh air
- To ventilate while cooling or heating the cab slowly

..... Fresh air intake

- To let in fresh air
- To remove fog from the windows
- To ventilate while cooling or heating the cab

Outlets

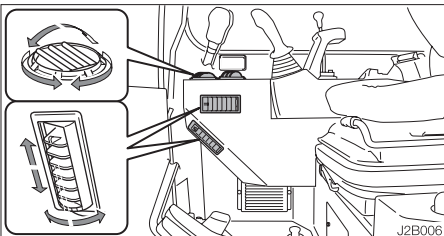

J2B006

Move the louvers up and down or left and right to adjust the air flow direction and amount.

OPERATION

**Heating and Dehumidifying
(in cold weather or when the humidity is high)**

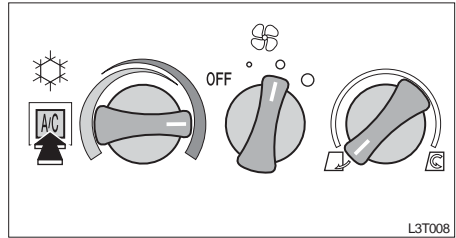

L3T008

After starting the engine, turn the air conditioner ON and adjust the switches as shown in the diagram above.

The outflow slot of foot area and the outflow slots of the defroster can be directed at the front window.

Warm, dehumidified air blows on the front window, preventing fogging.

Set the temperature control dial and fan switch to the desired positions.

Cooling

⚠ CAUTION

- When the air conditioner is set to the recirculation mode, the air in the cab gradually becomes dirty, so switch to external air to ventilate once a comfortable temperature is reached.
- Excessive cooling can be harmful to your health. It is best to keep the air inside the cab only about 5 to 6°C (9 to 11°F) cooler than the outside air.
- If the excavator has been parked in the sun, open the windows or door to let the hot air out of the cab before using the air conditioner.

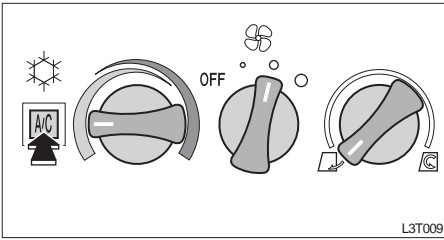

After starting the engine, turn the air conditioner ON and adjust the switches as shown in the diagram above. Set the temperature control dial and fan switch to the desired positions.

Quick cooling

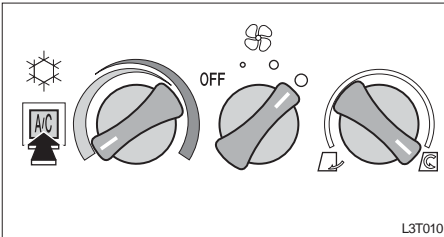

To cool the cab quickly, set the airflow mode control dial to the recirculation position and the fan switch to High, as shown on the diagram above.

Defogging the Windows

CAUTION

If the air conditioner is set to high when using the defroster, the difference between the external and internal temperatures increases, and fog may form on the outside of the windows. If this happens, either turn the air conditioner OFF or turn the temperature control dial clockwise (WARM).

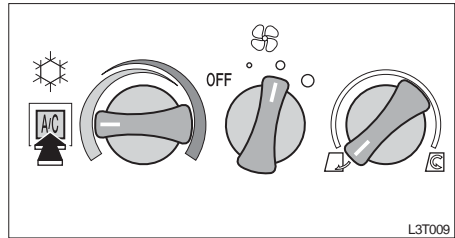

After starting the engine, turn the air conditioner ON and adjust the switches as shown in the diagram above.

The outflow slot of foot area and the outflow slots of the defroster can be directed at the front window.



INSPECTION AND MAINTENANCE

Inspection and maintenance interval
 Every 250 hours

Cleaning the Condenser

⚠ CAUTION

Cleaning the condenser with high pressured water may damage it. Clean the condenser gently.

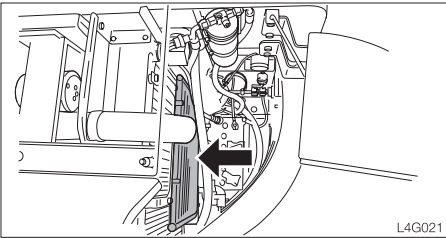

If the condenser is dirty, heat will not discharge properly. Wash dirt off the condenser with water.

1. Open the rear cover.
2. Clean the condenser.

Inspecting and Adjusting the Air Conditioner Belt

Inspection and maintenance interval
 ... After first 50 hours (New machines only)

IMPORTANT: Do not let any oil or grease get on the belt, as it will cause the belt to slip, shortening its service life and reducing the air conditioner's cooling capacity.

If the belt is slack, it will slip and vibrate, shortening its service life and reducing the air conditioner's cooling capacity. The belt should also not be too tense. Adjust the belt tension to the standard value (approximately 8 mm or 0.3 in.).

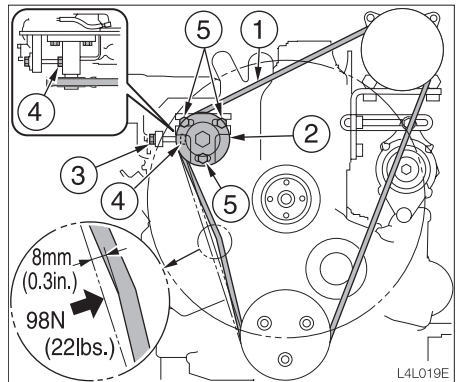
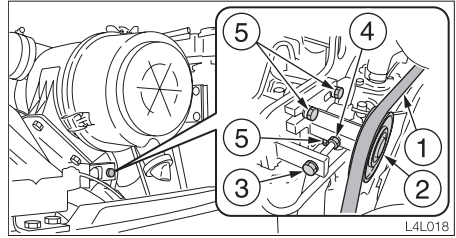

Inspection

1. Tilt up the platform.
2. Press on the center of the belt (1) with a finger. The belt's tension is normal if it bends about 8 mm (0.3 in.) when pressed with a force of about 98N or 22 lbs.

Adjustment

If the belt's tension is not normal, adjust it with the adjust bolt (3).

1. Loosen the nut (4) and bolts (5).
2. Tighten the bolt (3) to increase the tension. Loosen the bolt (3) to decrease the tension.
3. After adjusting is completed, tighten the nut (4) and bolts (5).



Replace

Replace the belt in the following cases:

- If it stretches and its tension cannot be adjusted.
- If it is cut or cracked.
- If the fan belt is worn and the pulley is touching the bottom of the V groove.

Cleaning the Filters

Clean the filters sooner when operating in dusty places.

If the filters are clogged, the air becomes weak and a muted booming sound is heard from the air conditioner unit.

Removing the filters

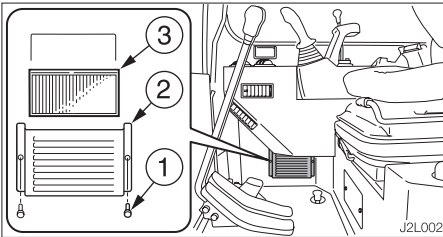

1. Loosen the bolts (1) and remove the cover (2).
2. Remove the inner filter (3).

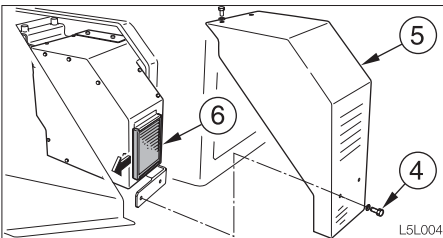

3. Loosen the bolts (4) and remove the cover (5).
4. Remove the outer filter (6).

5. Use compressed air to clean the filters.

Cleaning



Wear safety glasses when using compressed air.

1. Blow dry, compressed air (138 kPa or 20 psi or less) directly on the filter from the inside, moving up and down along the creases.
Be sure to keep the nozzle at an adequate distance from the filter.



Inspecting the Refrigerant (gas) Level

⚠ WARNING

Exposure of the eyes or hands to the cooler's refrigerant could result in blindness or frostbite. Never touch the refrigerant or loosen the parts of the cooling circuit. Should the refrigerant gas leak, keep flames away.

The cooling capacity will decrease if the amount of refrigerant is insufficient.

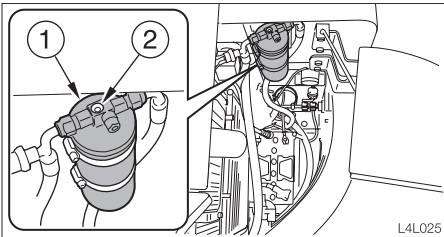

Inspect the refrigerant level using the sight glass (2) on the top of the receiver drier (1).

1. Open the rear cover.
2. Inspect under the following conditions:
 - Cab door Fully open
 - Temperature control dial Fully to the COOL side
 - Air strength High
 - Engine speed 1500 rpm
 - Air conditioner ... On
3. Inspect by watching the flow of air bubbles in the refrigerant through the sight glass (2). Refer to page 222 "Condition of the refrigerant".

⚠ CAUTION

The high pressure pipe becomes hot (80 to 120°C (176 to 248°F)), so be careful not to burn yourself when inspecting the refrigerant level.

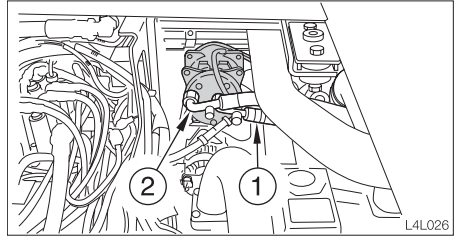

4. Open the engine hood.
5. Tilt up the cab.
Refer to page 154 "Tilting Up the Platform".
6. Also check the temperature of the compressor's high pressure pipe (1) and low pressure pipe (2). Refer to page 222 "Condition of the refrigerant."

Off-Season Inspection

Even off season, run the cooler for 3 to 5 minutes at least once a week to maintain oil in the various parts of the compressor.

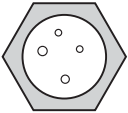
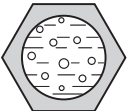
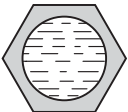
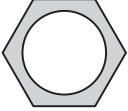

Condition of the Refrigerant

Sight glass (refrigerant)		High/low pressure pipe temperature	Pipe connection
<p>Normal</p> 	<p>Almost transparent, with some bubbles, but fully transparent when the engine speed is increased or decreased.</p>	<p>High pressure pipe (1) hot (80 to 120°C, 176 to 248°F), low pressure pipe (2) cold (8 to 15°C, 46 to 59°F). Clear difference in temperature between the pipes.</p>	<p>No irregularities.</p>
<p>Refrigerant low</p> 	<p>Flow of bubbles can be seen constantly. Refrigerant is sometimes transparent or has white bubbles. Refrigerant may be leaking.</p>	<p>High pressure pipe warm, low pressure pipe somewhat cool. No great difference in temperature between the pipes.</p>	<p>Some oily places.</p>
<p>Almost no refrigerant</p> 	<p>Some mist-like refrigerant can be barely seen flowing. Refrigerant has leaked, and almost none is left.</p>	<p>Almost no difference in temperature between the high and low pressure pipes.</p>	<p>Some heavily oily places.</p>
<p>Excess refrigerant</p> 	<p>No bubbles can be seen, even when the fan is set to high and the engine is idling.</p>	<p>High pressure pipe is hot, low pressure pipe is somewhat cool. There is a difference in temperature between the pipes.</p>	<p>No irregularities.</p>

If the air conditioner does not function

If the air conditioner does not cool or heat the air, set the fan switch to OFF and contact a service outlet for inspection and/or repairs.

IMPORTANT: Continued use of the air conditioner when it is not functioning properly may damage its various parts.

IMPORTANT: Using the air conditioner when there is no refrigerant will damage the compressor. Be particularly careful not to do this.

IMPORTANT: Always have a service outlet add or replace the refrigerant. Be sure to use R134a refrigerant (800g or 1.76 lb).

MEMO

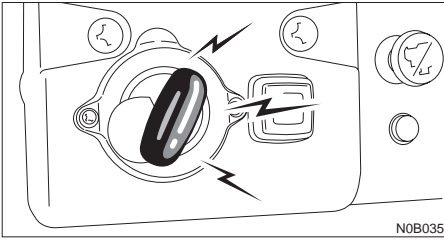

The immobilizer system is a device that protects the machine from theft through the use of falsified keys, etc. Signals are exchanged between the machine and the key, and the engine cannot be started unless the key is one of the included immobilizer keys or the registration key. If an attempt is made to force the engine to start using a falsified key, an alarm device is activated.

Stopping the alarm

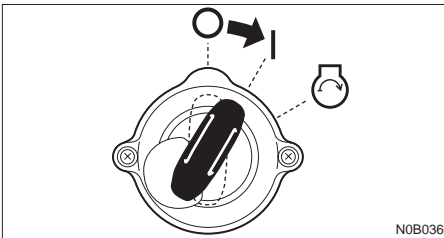

Using one of the included immobilizer keys or the registration key, turn the starter switch from OFF (O) to ON (I). When the signal is identified, the alarm stops.

Keys

The machine comes with two immobilizer keys and one registration key. The keys are used for the immobilizer system (theft prevention device).

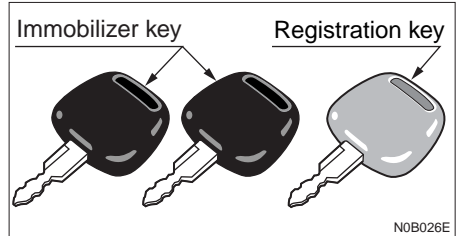

- Immobilizer key (key grip: black)
The immobilizer key is used not only to start and stop the engine, but also to lock and unlock the following places:
 - Fuel filler cap
 - Cab door
 - Covers
- Registration key (key grip: gray)
The registration key is used for key re-registration (rewriting the ID code). It can also be used in the same way as the immobilizer keys. If an immobilizer key is lost and a new immobilizer key is purchased, re-register the keys.
Refer to page 226 "Re-Registration of the key".

Immobilizer keys can be ordered individually. If the registration key is lost, however, the immobilizer system must be replaced. Be particularly careful not to lose the registration key, and store it separately from the immobilizer keys.



IMPORTANT: If a key from a different immobilizer system or a metal object is brought near or into contact with the starter switch or key section, the system may no longer be able to identify the keys' ID codes, in which case it is no longer possible to start the engine.

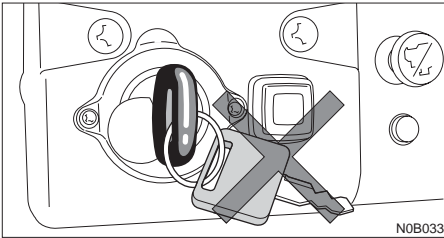

- Do not place keys for another immobilizer system together with your machine's keys.

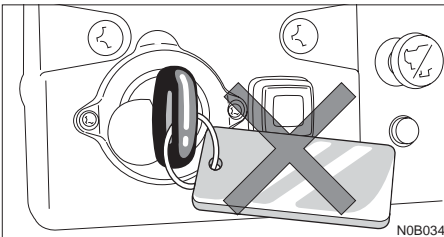

- Do not use metal key holders.



Re-Registration of the Keys

Re-register the keys in the following cases:

- If one of the immobilizer keys is lost, re-register the remaining keys so as to prevent theft.
- If you purchase new immobilizer keys, they must be registered before they can be used with the machine's immobilizer system.
- The ID code is changed each time a key is registered, so any keys you already have must also be re-registered.

Refer to page 224 "Immobilizer System".

IMPORTANT: Please read and understand the registration procedure before starting. If you stop in the middle, you may have to start over from the beginning.

Do not turn the key to the START () position while performing the steps 3 to 12.

Registration Procedure

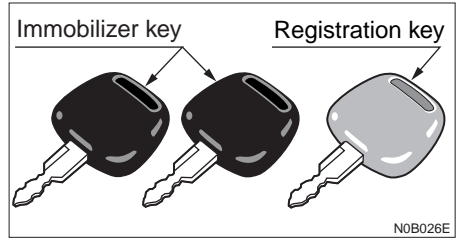

1. Prepare the immobilizer keys you wish to register (key grip: black/maximum of 5 keys) and the registration key (key grip: gray).
2. Check whether or not the engine starts with the registration key. If the engine does not start, it is possible that the registration key belongs to another product. This matter must be checked again.

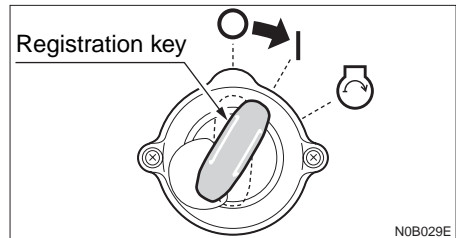

3. Insert the registration key into the starter switch and turn it from the OFF (O) position to the ON (I) position.
4. Hold for about 10 seconds.

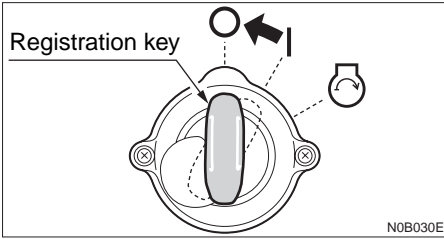

5. Return to the OFF (O) position from the ON (I) position and remove the registration key.

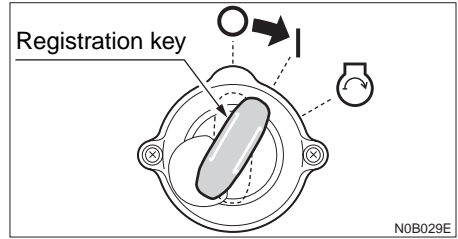

10. Within 10 seconds after registering the immobilizer keys, insert the registration key into the starter switch and turn it from the OFF (O) position to the ON (I) position.
11. Hold for about 10 seconds.

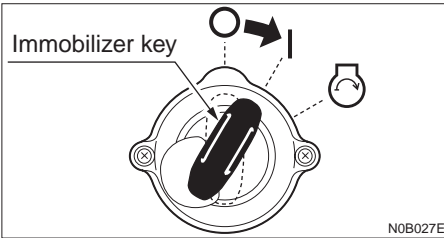

6. Within 10 seconds, insert the immobilizer key into the starter switch and turn it from the OFF (O) position to the ON (I) position.
7. Hold for about 10 seconds.

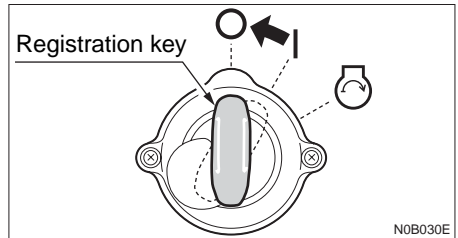

12. Return to the OFF (O) position from the ON (I) position and remove the registration key.
This completes the registration procedure.
13. Check that the engine starts using all the registered keys (registration key and immobilizer keys).
If the engine does not start, re-register the keys.
If the engine still does not start, consult a Takeuchi sales or service outlet.

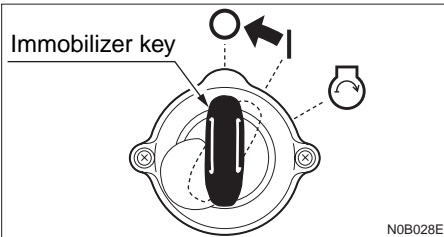

8. Return to the OFF (O) position from the ON (I) position and remove the immobilizer key.
9. Perform steps (6) to (8) for all immobilizer keys (maximum of 5 keys) that you wish to register.



INDEX

**D**

Daily Inspection	68
Daily Inspection (Every 10 Hours)	120
Danger of flying objects	22
Decel. Button	49
Defogging the Windows	218
Disconnect the battery	30
Disposing of wastes	31
Do not allow unauthorized personnel in the work area	25
Do not overcool	214
Do not permit riders on the machine	16
Do not turn the air conditioner on until the engine is started	214
Doors and Covers	38
Draining the fuel tank	132

E

Emergency Shut-off Valve	202
Engine Hood	41
Ensure good visibility	16
Every 1000 Hours	138
Every 2000 Hours	142
Every 250 Hours	134
Every 50 Hours	128
Every 500 Hours	137
Excavators are not designed for lifting loads	21
Exhaust fumes from the engine can kill	11
Expendables	112
External Power Sockets (for EU)	59

F

Fan Switch	216
First Auxiliary Hydraulic Lines	64

First Auxiliary Hydraulic Switches	51
Fourth Auxiliary Hydraulic Lines	210
Fourth Auxiliary Hydraulics < TB180FR >	210
Front Window (Cab)	39
Fuel Filler Cap	42
Fuel Supply Pump < TB180FR >	213

G

General	108
General Precautions	8
General Precautions	194
Getting Out of Mud	94

H

Handling asbestos dust	11
Handling in Cold Weather	97
Handling of hoses	28
Handling of the accumulator	29
Handling Rubber Crawlers	98
Have a Takeuchi service agent repair welding cracks or other damage	31
Heater (Cab)	56
Heating and Dehumidifying (in cold weather or when the humidity is high)	217
Hoist the machine safely	24
Hoisting the Machine < TB153FR >	103
Hoisting the Machine < TB180FR >	104
Horn Button	49
Hydraulic Breaker	200

I

If a Fuse Blows	166
If a Warning Lamp Flashes	169
If the Battery Goes Dead	164



If the Engine Overheats 163

Immobilizer System 224

Important Parts 115

In cold weather 15

Index 229

Indicators 47

Inspecting and Adjusting the Air Conditioner Belt 219

Inspecting and adjusting the crawler tension 128

Inspecting and adjusting the engine valve clearance 141

Inspecting and adjusting the fan belt 127

Inspecting and adjusting the fan belt 134

Inspecting and Cleaning the Pre Cleaner 205

Inspecting and Replacing the Fuse 166

Inspecting and replenishing the coolant 120

Inspecting and replenishing the engine oil 121

Inspecting and replenishing the windshield washer
fluid 145

Inspecting by opening the engine hood and covers .. 118

Inspecting by walking around the machine 119

Inspecting the battery fluid level and replenishing ... 131

Inspecting the engine fuel injection pressure and spray
condition 141

Inspecting the engine fuel injection timing 144

Inspecting the engine fuel injection valve 144

Inspecting the fuel level 122

Inspecting the Fusible Link 167

Inspecting the hydraulic oil level and replenishing ... 122

Inspecting the Refrigerant (gas) Level 221

Inspecting the rubber crawlers 155

Inspecting the water separator 121

Inspecting while sitting in the operator's seat 119

Inspection After Warm-up 77

Inspection and Checks After Stopping the Engine 96

Instrument Cluster 46

Insure driver safety before loading trucks 19

Interior Light (Cab) 57

Introduction 2

K

Keep a safe distance from electrical power lines 19

Keys 224

Know the working area 12

L

Let hot air out first 214

Lever Pattern (ISO Pattern) 74

Lever Pattern (JCB Pattern) 75

Levers and Pedals 53

Lifting Capacities 183

Light Switch 52

Load and unload the machine safely 24

Load Safety Device 202

Loading and Unloading 102

Long-term Storage 160

Lower Front Window (Cab) 40

Lubricant and Fuel Chart 110

Lubricating the levers 146

Lubricating the slew bearing 130

Lubricating the working equipment 124

M

Machine Description 3

Machine Dimensions 178

Machine Operation 74

Main Specifications 176

Maintain three point contact when mounting and
dismounting 14

Maintenance 107

Maintenance Chart 116

Maintenance Description 108

Maintenance Precautions 25

Meters 47



Mounting and Dismounting 68

N

Names of Components 36
 Never modify the machine 11
 Never remove safety equipment 9
 Never slew (swing) sideways with excessive weights 21

O

Observe all safety rules 8
 Off-Season Inspection 221
 Offset Pedal 55
 Operate on snow or ice with extra care 18
 Operating Levers 53
 Operating on slopes is dangerous 20
 Operating Precautions 16
 Operating Procedures 88
 Operating Range 180
 Operating the First Auxiliary Hydraulics 86
 Operating the Machine with Accumulator 204
 Operating the Travel Levers 79
 Operating the Working Equipment 84
 Operation 67
 Operations Possible with this Machine 94
 Options 193
 Other Symptoms 170
 Outlets 217
 Overload Warning Device 203

P

Park safely 23
 Parking 96
 Parking the Machine 96

Perform inspection and maintenance daily 13
 Place heavy objects in a stable position 27
 Pre Cleaner < TB180FR > 205
 Precautions on Installing Attachments 194
 Precautions on Operating 200
 Precautions on Operating Attachments 195
 Precautions on Safety 194
 Prepare the work area 26
 Preparing for Cold Weather 97
 Preparing Precautions 12
 Prohibited Actions 98
 Prohibited Operations 88
 Provide a fire extinguisher and first aid kit 9

R

Radio 60
 Rear Cover 41
 Release all pressure before working on the hydraulic system 29
 Replace important safety parts periodically 25
 Replace the hydraulic oil regularly! 111
 Replace the Hydraulic Oil Regularly! 201
 Replacing the air breather filter 141
 Replacing the air cleaner element 140
 Replacing the bucket 148
 Replacing the bucket teeth and the side cutters < TB153FR > 150
 Replacing the bucket teeth and the side cutters < TB180FR > 152
 Replacing the engine oil and oil filter 126
 Replacing the engine oil and oil filter 134
 Replacing the fuel filter 137
 Replacing the hydraulic oil and cleaning the suction strainer 142
 Replacing the hydraulic oil return filter 125
 Replacing the hydraulic oil return filter 137



Replacing the rubber crawlers < TB153FR > 156
 Replacing the rubber crawlers < TB180FR > 158
 Replacing the travel motor gear oil 133
 Replacing the travel motor gear oil 141
 Re-Registration of the Keys 226
 Retightening the engine cylinder head bolts 141

S

Safety 7
 Safety Lock Lever 53
 Safety Signs (Decals) 32
 Safety Signs (Decals) 196
 Seat 44
 Seat and Seat Belt 44
 Seat Belt 45
 Second / Fourth Auxiliary Hydraulic Switch 211
 Second Auxiliary Hydraulic Lines 206
 Second Auxiliary Hydraulic Switch 207
 Second Auxiliary Hydraulics 206
 Secure the engine hood or cover when opened 27
 Securely block the machine or any component that
 may fall 27
 Securely block the working equipment 27
 Securing the Machine 105
 Selector Button (2nd or 4th Aux.) 211
 Service Data 110
 Side Window (Cab) 40
 Specifications 175
 Start the engine from the operator's seat 14
 Starter Key 38
 Starter Switch 48
 Starting and Stopping the Engine <TB153FR> 70
 Starting and Stopping the Engine <TB180FR> 72
 Starting Precautions 14
 Starting the Engine 70
 Starting the Engine 72

Starting with jumper cables 15
 Stay clear of moving parts 26
 Stop the engine before performing maintenance 26
 Stopping Precautions 23
 Stopping the Engine 71
 Stopping the Engine 73
 Switches 48
 Switching the Lever Pattern 198
 Symptoms that are not Malfunctions 162

T

Temperature Control Dial 216
 Third Auxiliary Hydraulic Lines 208
 Third Auxiliary Hydraulic Switch and Button 209
 Third Auxiliary Hydraulics 208
 Third Auxiliary Hydraulics Warning Lamp 209
 3-Hole Bucket < TB180FR > 199
 Throttle Controller < TB180FR > 49
 Throttle Lever < TB153FR > 54
 Tightening Torques 114
 Tilting up the platform 154
 To Lower the Boom 172
 Tool Case 40
 Tools 113
 Towing 174
 Transport 101
 Transport the machine safely 24
 Transporting Precautions 24
 Travel Alarm 212
 Travel Levers 54
 Travel safety 17
 Travel Speed Switch 51
 Troubleshooting 161

U



Use a signal person and flagman	9
Use caution when fueling	28
Use the correct tools	25
Using optional products	11

V

Ventilate periodically	214
Vibrations to which the operator is subjected	31

W

Walk-Around Inspection	68
Walk-Around Inspection	118
Warming Up the Engine	71
Warming Up the Engine	73
Warming Up the Machine (Hydraulic Oil)	76
Warning Lamps	46
Watch boom clearance	21
Watch out for hazardous working conditions	20
Wear appropriate clothing and personal protective equipment	8
When Required	145
Wiper Switch (Cab)	52

First Published April 2006

No.23190

OPERATOR'S MANUAL

TB153FR
TB180FR Hydraulic Excavator

Edited and issued by TAKEUCHI MFG. CO., LTD.

Printed in Japan by STATION M Co., Ltd.

CALIFORNIA

Proposition 65 Warning

Diesel engine exhaust and some of its constituents are known to the State of California to cause cancer, birth defects, and other reproductive harm.

Battery posts, terminals and related accessories contain lead and lead compounds, chemicals known to the State of California to cause cancer and birth defects or other reproductive harm. Wash hands after handling battery.