

These operational amplifier are short circuit protected against $+V_{CC}$, $-V_{CC}$ and ground. No external components for frequency compensation are required. An internal gain reduction of 6 dB/octave yields maximum stability in feedback circuit applications.

- Simple handling
- Large input differential voltage
- Short circuit protected
- High open loop voltage gain
- Large supply voltage range

Type	Ordering codes
TBA 221	Q67000-A134
TBA 221 A	Q67000-A225
TBA 221 B	Q67000-A281
TBA 221 W	Q67000-A923
TBA 221 G	Q67000-A923 G
TBA 222	Q67000-A97
TBA 222 Q1	Q67000-A97-Q1
TBA 222 Q2	Q67000-A97-Q2
TBA 222 S1	Q67000-A97-S1

Package outlines

TBA 221, TBA 222

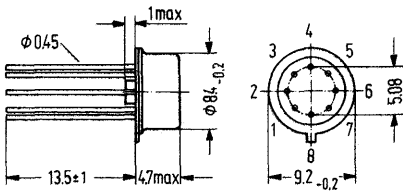

Case similar to 5 G 8 DIN 41873 (TO-99)
Weight approx. 1.2 g
Pin 4 and case connected

TBA 221 B

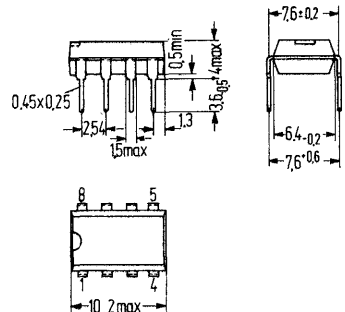

Plastic plug-in package, 8 pins
20 A 8 DIN 41866
Weight approx. .7 g

Dimensions in mm

Package outlines

TBA 221 A

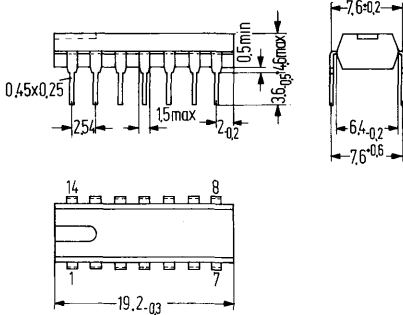

Plastic plug-in package, 14 pins
 20 A 14 DIN 41866 (TO-116)
 Weight approx. 1.1 g

TBA 221 W

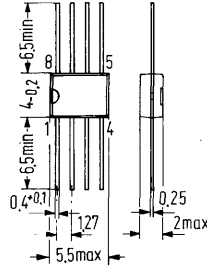

Miniature plastic package, 8 pins
 Weight approx. .15 g
 Colour code brown/brown

TBA 221 G

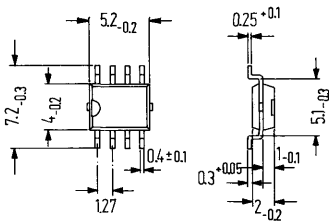

Miniature plastic package, 8 pins
 Weight approx. .15 g

Dimensions in mm

Pin connection

TBA 221 B

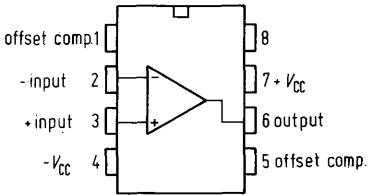

TBA 221, TBA 222, TBA 222 Q1, TBA 222 Q2
TBA 222 S 1

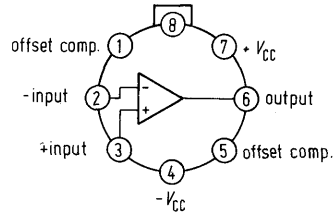

TBA 221 A

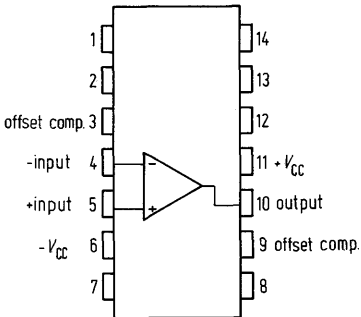

TBA 221 W, TBA 221 G

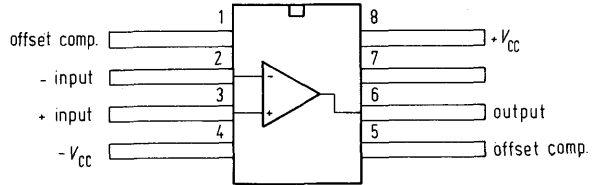

TBA 221; A; B; W; G-741
TBA 222; S1; Q1; Q2-741

Maximum ratings

		TBA 221 TBA 221 A TBA 221 B TBA 221 G TBA 221 W	TBA 222 TBA 222 Q 1 TBA 222 Q 2 TBA 222 S 1	
Supply voltage	V_{CC}	± 18	± 22	V
Input voltage ($V_{CC} = \pm 4$ to ± 15 V)	V_i	$\pm V_{CC}$	$\pm V_{CC}$	V
Input voltage ($V_{CC} = \pm 15$ to ± 18)	V_i	± 15	± 15	V
Differential input voltage	V_{iD}	± 30	± 30	V
Short circuit duration ¹⁾	t_{SC}	∞	∞	
Storage temperature	T_S	-65 to +150	-65 to +150	°C
Junction temperature	T_j	150	150	°C
Thermal resistance: System-case (TBA 221/222)	$R_{thScase}$	80	80	K/W
System-ambient air (TBA 221/222)	R_{thSamb}	190	190	K/W
System-ambient air (TBA 221 A)	R_{thSamb}	120		K/W
System-ambient air (TBA 221 B)	R_{thSamb}	140		K/W
System-ambient air (TBA 221 W/G)	R_{thSamb}	200		K/W

Range of operation

Supply voltage	V_{CC}	± 4 to ± 18	± 4 to ± 22	V
Ambient temperature in operation	T_{amb}	0 to +70	-55 to +125	°C

¹⁾ Short circuit may be ground or $\pm V_{CC}$, thereby the maximum ratings like T_j must not be exceeded.

Circuit diagram

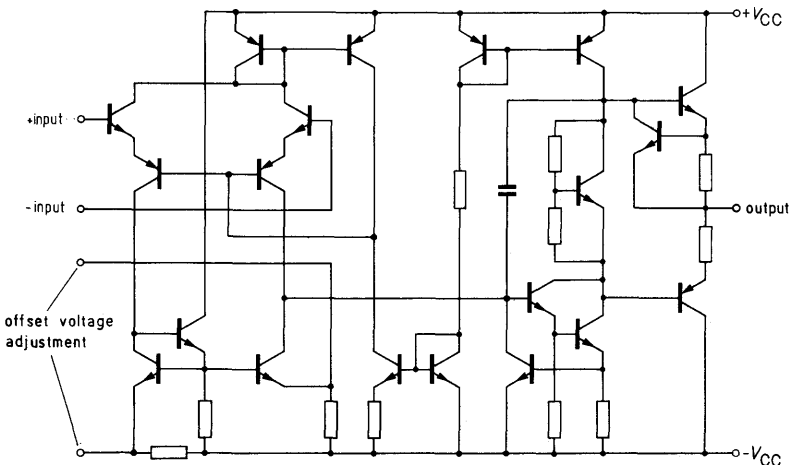

Operating characteristics

($V_{CC} = \pm 15\text{ V}$, $T_{amb} = 25^\circ\text{C}$
when not otherwise stated)

	TBA 221			TBA 222				
	TBA 221 A TBA 221 B TBA 221 G TBA 221 W			TBA 222 Q 1 TBA 222 Q 2 TBA 222 S 1				
	min	typ	max	min	typ	max		
Input offset voltage ($R_G \leq 10\text{ k}\Omega$, $T_{amb} = 0\text{ to }70^\circ\text{C}$)	V_{io}	-6		6	-4	4	mV	
($R_G \leq 10\text{ k}\Omega$, $T_{amb} = -55\text{ to }+125^\circ\text{C}$)	V_{io}	-7.5		7.5			mV	
Adjustable range of input offset voltage	ΔV_{io}	6	± 15	-6	6	± 15	mV	
Input offset current ($T_{amb} = 0\text{ to }70^\circ\text{C}$)	I_{io}	-200	± 20	200	-100	± 20	nA	
($T_{amb} = -55\text{ to }+125^\circ\text{C}$)	I_{io}	-300		300			nA	
Input current ($T_{amb} = 0\text{ to }70^\circ\text{C}$)	I_i		80	500	80		nA	
($T_{amb} = -55\text{ to }+125^\circ\text{C}$)	I_i			800			nA	
Current supply	I_{cc}		1.7	2.8	.3	1.2	μA	
Positive output short circuit current	I_{qsc+}	15	20	25	15	20	25	mA
Negative output short circuit current	I_{qsc-}	-25	-20	-15	-25	-20	-15	mA
Input resistance	R_i	300	2000		300	2000	k Ω	
Input capacitance	C_i		1.4			1.4	pF	
Output resistance	R_o		75			75	Ω	
Output voltage ($R_L \geq 10\text{ k}\Omega$)	V_{qpp}	12	± 14	-12	13	± 14	-12.5	V
($R_L \geq 2\text{ k}\Omega$)	V_{qpp}	10	± 13	-10	11	± 13	-11	V
Common mode input voltage range	V_{ICM}	12	± 13	-12	12	± 13	-12	V
Voltage gain ($V_{qpp} = \pm 10\text{ V}$, $R_L \geq 2\text{ k}\Omega$)	G_v	86	100		94	106		dB
($V_{qpp} = \pm 10\text{ V}$, $R_L \geq 2\text{ k}\Omega$, $T_{amb} = 0\text{ to }70^\circ\text{C}$)	G_v	83.5						dB
($V_{qpp} = \pm 10\text{ V}$, $R_L \geq 2\text{ k}\Omega$, $T_{amb} = -55\text{ to }+125^\circ\text{C}$)	G_v				88			dB
Common-mode rejection ratio	$CMRR$	70	90		80	90		dB
Sensitivity to supply voltage variations	$\frac{\Delta V_{io}}{\Delta V_{cc}}$		30	150		30	150	$\mu\text{V/V}$
Transient behaviour of the output voltage at $G_v = 1$:								
Rise time ($V_i = 20\text{ mV}$, $R_L = 2\text{ k}\Omega$, $C_L < 100\text{ pF}$)	t_r		.3			.3		μs
Overshoot			5			5		%
Leading edge slope ($R_L \geq 2\text{ k}\Omega$)	$\frac{dV_{qpp}}{dt}$.5			.5		V/ μs
Temperature coefficient of V_{io}	$\alpha_{V_{io}}$					3		$\mu\text{V/K}$
Temperature coefficient of I_{io}	$\alpha_{I_{io}}$.4		nA/K

TBA 222 Q 1: similar to TBA 222, however with special quality features

1. Burn-in at $T_{amb} = 80^{\circ}\text{C}$, 168 hours; $V_{CC} = \pm 15\text{ V}$ according to the test-circuit
2. Noise voltage $< 5\ \mu\text{V}_p$, according to the test-circuit and DIN 45405
3. AQL, critical electrical defects: 0.25

TBA 222 Q 2: similar to TBA 222, however with guaranteed noise voltage $< 5\ \mu\text{V}_p$ according to the test circuit AQL, critical electrical defects: 0.25

TBA 222 S 1: similar to TBA 222 Q 1, however with another burn-in.

1. Burn-in at $T_{amb} = 50^{\circ}\text{C}$, 168 hours, $V_{CC} = \pm 22\text{ V}$ according to the test-circuit
2. Noise voltage $< 5\ \mu\text{V}_{pp}$
3. AQL, critical electrical defects: 0.25

Burn-in circuit for TBA 222 Q 1

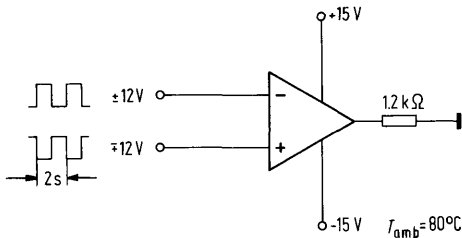

Burn-in circuit for TBA 222 S 1

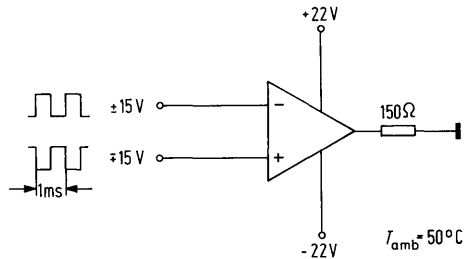

Test circuit for noise voltage: TBA 222 Q 1
 TBA 222 Q 2
 TBA 222 S 1

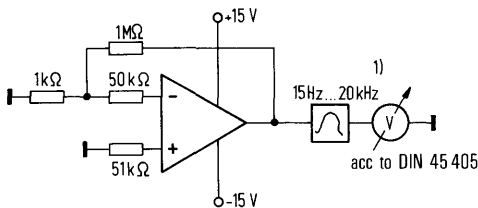

1) for TBA 222 S 1: 0.1 Hz to 20 kHz

Open-loop voltage gain
 $G_V = f(V_{CC})$

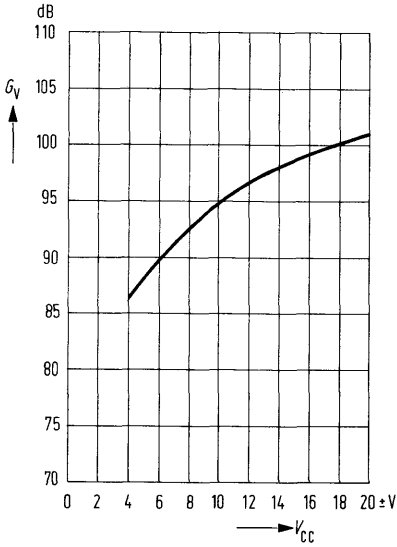

Output voltage $V_q = f(V_{CC})$
 $R_L \geq 2 \text{ k}\Omega$

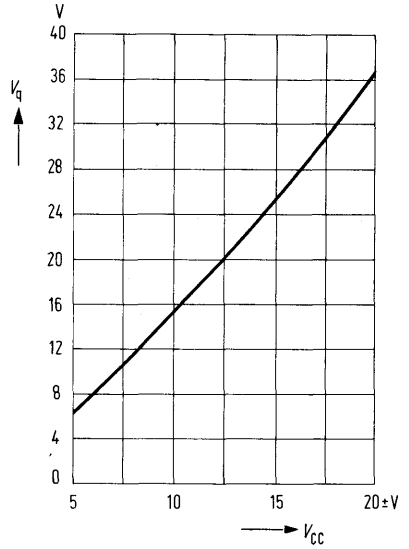

Common mode voltage range $V_{ICM} = f(V_{CC})$
 $R_L = 2 \text{ k}\Omega$

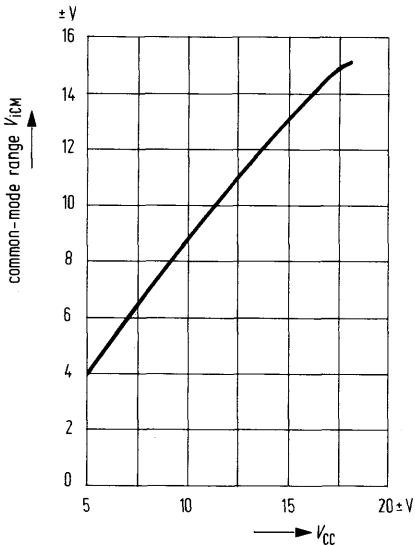

Short circuit current $I_{SC} = f(T_{amb})$

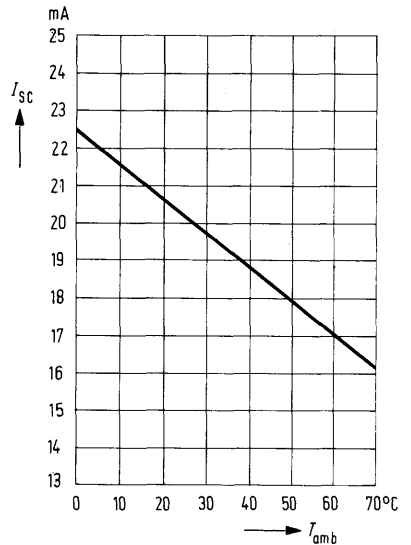

Input current $I_i = f(T_{amb})$
 $V_{CC} = \pm 15\text{ V}$

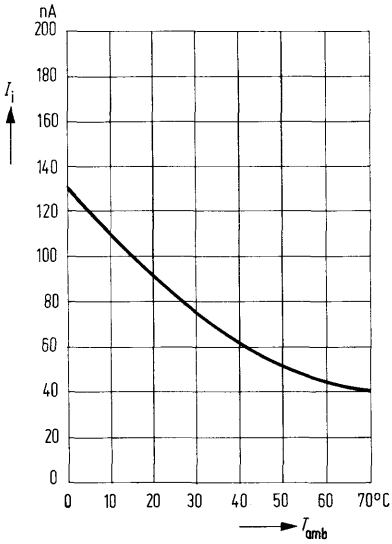

Input resistance $R_i = f(T_{amb})$
 $V_{CC} = \pm 15\text{ V}$

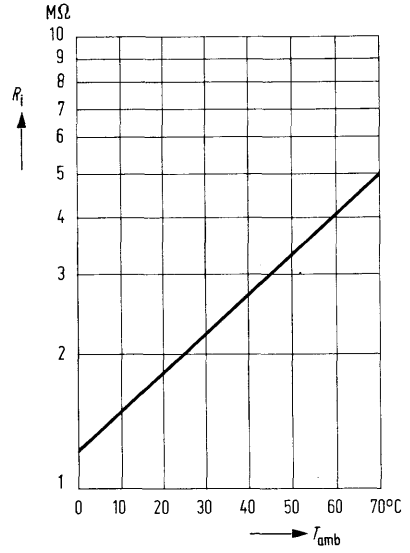

Input offset current $I_{i0} = f(V_{CC})$

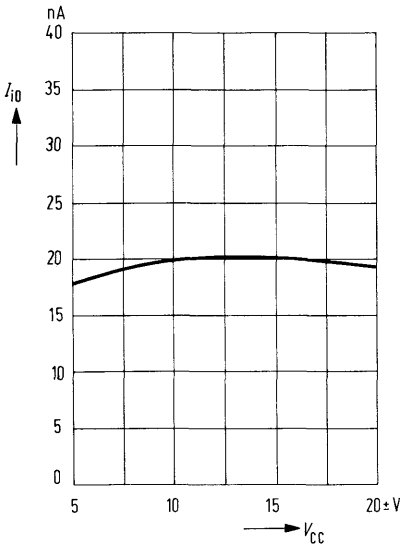

Input offset current $I_{i0} = f(T_{amb})$
 $V_{CC} = \pm 15\text{ V}$

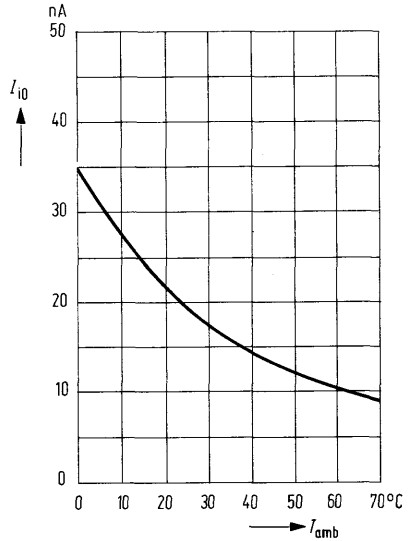

Output voltage $V_{app} = f(R_L)$
 $V_{cc} = \pm 15\text{ V}$

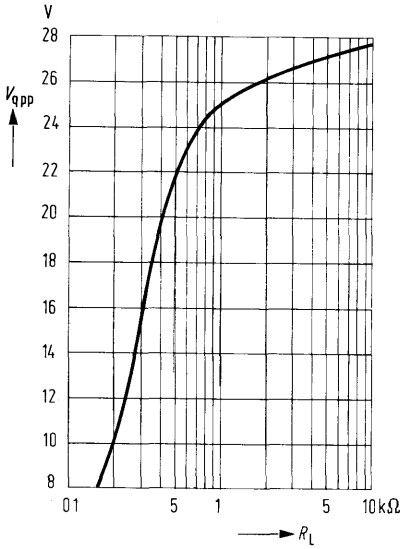

Phase of open-loop voltage gain
 $\varphi = f(f); V_{cc} = \pm 15\text{ V}$

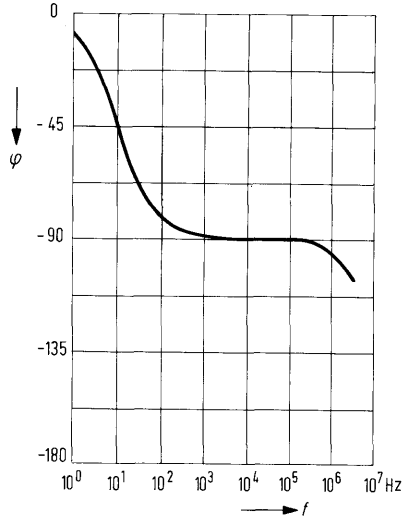

Output voltage $V_{app} = f(f)$
 $V_{cc} = \pm 15\text{ V}; R_L = 10\text{ k}\Omega$

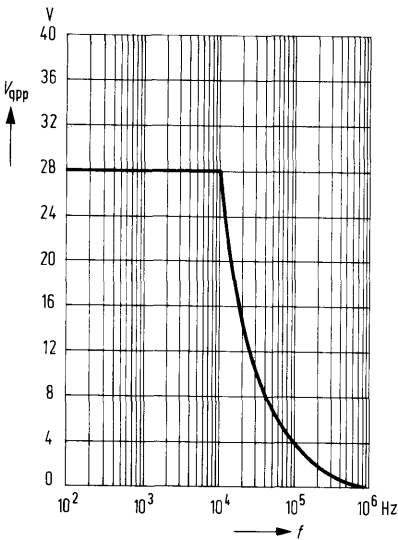

Input resistance $R_i = f(f)$
Input capacitance $C_i = f(f)$

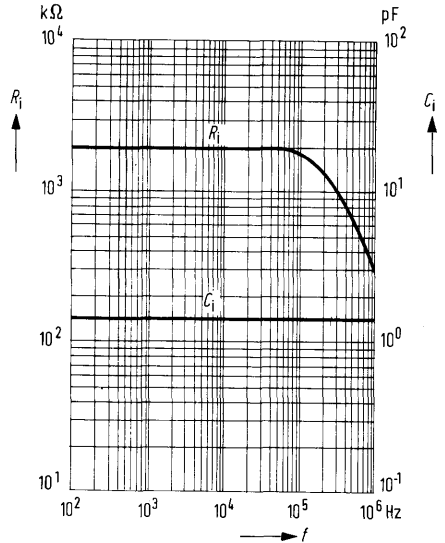

Output resistance $R_q = f(f)$

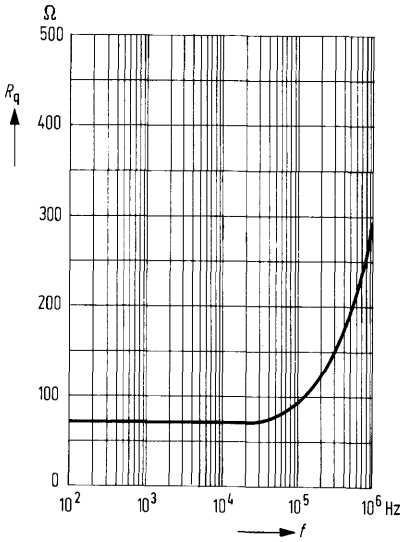

Open-loop voltage gain $G_V = f(f)$

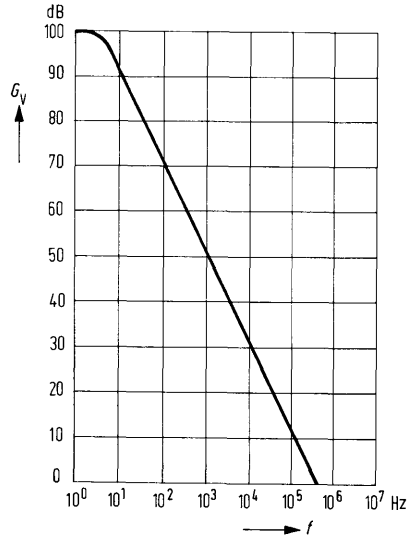

Supply current $I_{CC} = f(V_{CC})$

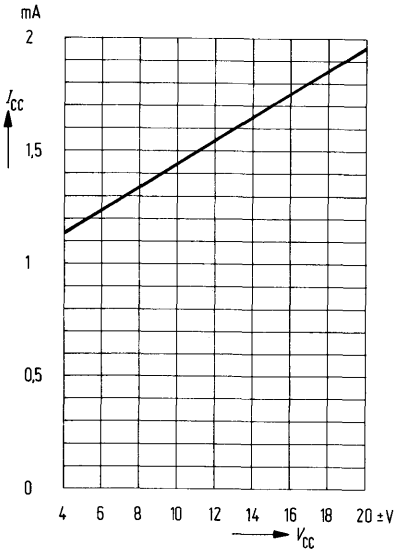

Offset voltage adjustment circuit

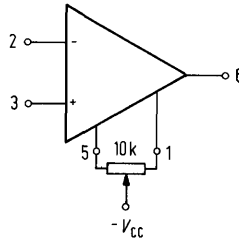

Test circuit for the transient behavior of V_{app}

