

# LINEAR INTEGRATED CIRCUIT

# TAA 550 TBA 271

## VOLTAGE STABILIZER

- LOW TEMPERATURE COEFFICIENT
- LOW ZENER RESISTANCE

The TAA 550/TBA 271 is a monolithic integrated voltage stabilizer in a TO-18 two pins metal case. It is especially designed as voltage supplier for varicap diodes in television tuners.

The TAA 550/TBA 271 is supplied in 3 groups of stabilized voltage identified by a letter after the code, as shown in the "ORDERING NUMBERS".

## ABSOLUTE MAXIMUM RATINGS

$I_z$	Zener current at $T_{case} \leq 70^\circ C$	15 mA
$T_{stg}$	Storage temperature	-20 to 150 °C
$T_{op}$	Operating temperature	*

\* Refer to "Power rating chart" (Fig. 1)

**ORDERING NUMBERS:** TAA 550 A or TBA 271 A (for  $V_z$  range : 30-32 V)  
TAA 550 B or TBA 271 B (for  $V_z$  range : 32-34 V)  
TAA 550 C or TBA 271 C (for  $V_z$  range : 34-36 V)

## MECHANICAL DATA

Dimensions in mm

Lead 1 connected to case

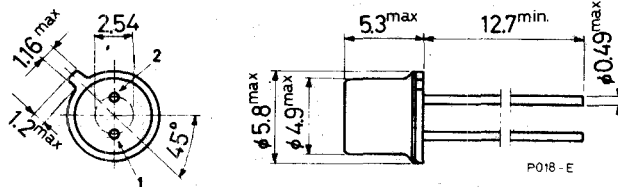

# TAA 550 TBA 271

## CONNECTION DIAGRAM (bottom view)

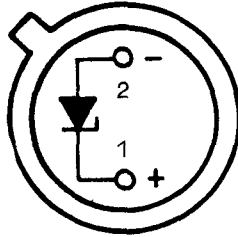

SS 0036

## SCHEMATIC DIAGRAM

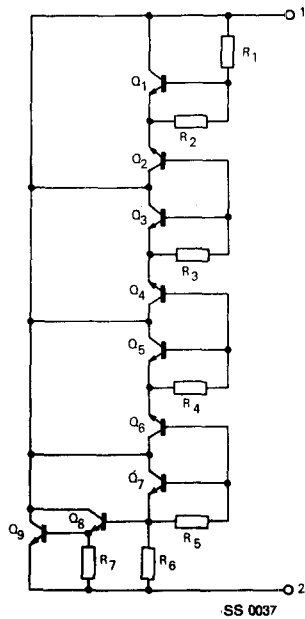

SS 0037

## TEST CIRCUITS

Circuit No. 1 (for  $V_z$  measurement)

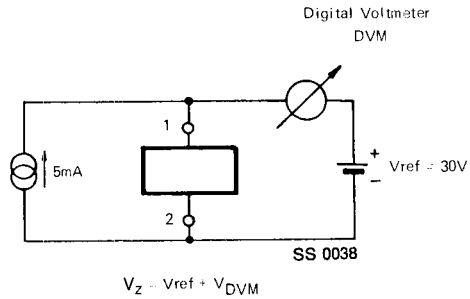

Circuit No. 2 (for  $r_z$  measurement)

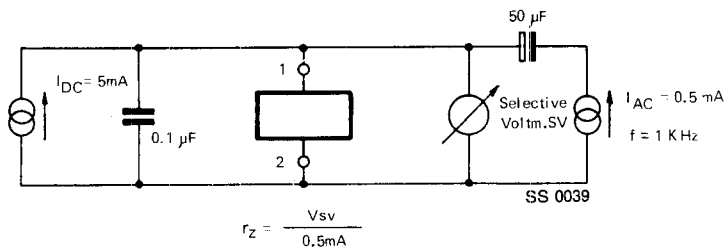

# TAA 550 TBA 271

## THERMAL DATA

$R_{th\ j-case}$	Thermal resistance junction-case	max	150	°C/W
$R_{th\ j-amb}$	Thermal resistance junction-ambient	max	400	°C/W

## ELECTRICAL CHARACTERISTICS ( $T_{amb} = 25\text{ °C}$ unless otherwise specified)

Parameter	Test conditions	Min.	Typ.	Max.	Unit
$V_z$ Zener voltage	$I_z = 5\text{ mA}$ (circuit No. 1) for TAA 550 A/TBA 271 A for TAA 550 B/TBA 271 B for TAA 550 C/TBA 271 C	30	31	32.2	V
		32	33	34.2	V
		34	35	36	V
$r_z$ Zener dynamic resistance	$I_z = 5\text{ mA}$ $I_{AC} = 0.5\text{ mA}$ $f = 1\text{ kHz}$ (circuit No. 2)		10	25	$\Omega$
$\frac{\Delta V_z}{\Delta T_{amb}}$ Temperature coefficient	$I_z = 5\text{ mA}$ $\Delta T_{amb} = 0\text{ to }50\text{ °C}$	-3.2		+1.6	mV/°C

Fig. 1 - Power rating chart

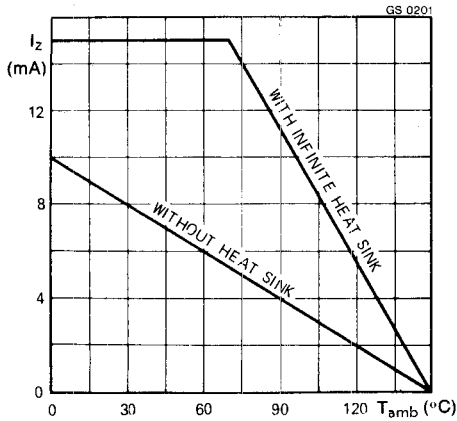

Fig. 2 - Typical zener dynamic resistance vs zener current

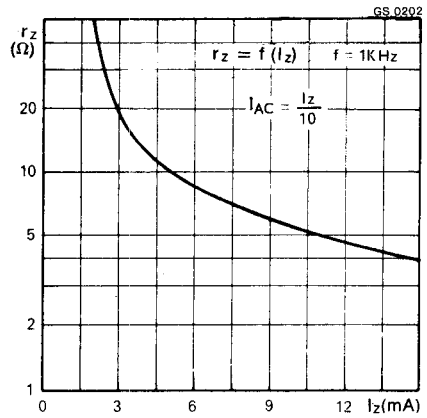

Fig. 3 - Typical temperature coefficient

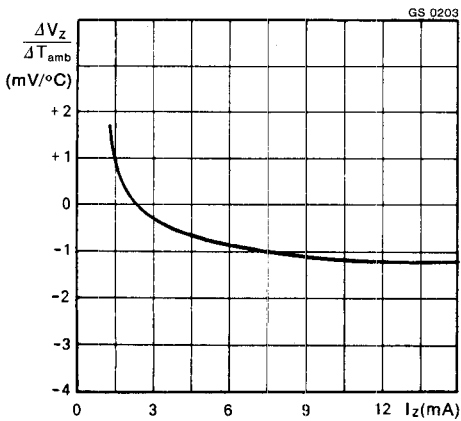
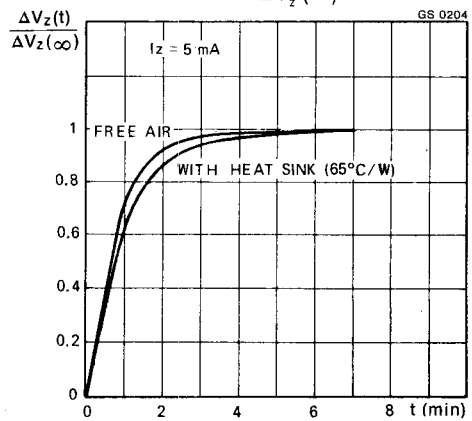

Fig. 4 - Typical  $\frac{\Delta V_z(t)}{\Delta V_z(\infty)}$  vs time



# TAA 550 TBA 271

## TYPICAL APPLICATION

