



TBA 440 N/P

VIDEO IF AMPLIFIER DEMODULATOR

The TBA440 (TBA440N for NPN tuners, TBA440P for PNP tuners) comprises a high-gain regulated video IF amplifier, a controlled demodulator and two low-resistance video outputs with positive and negative signal as well as the complete key control and delayed tuner control.

ABSOLUTE MAXIMUM RATINGS

Supply voltage steady	15V
transitory	16.5V
Voltage at pin 5	20V
Voltage at pin 4	5V
Voltage at pin 14	5V
Operating ambient temperature	-10° to +60°C
Total power dissipation at T _{amb} ≤ 55°C	700mW
Ohmic resistance between pins 8 and 9	20Ω

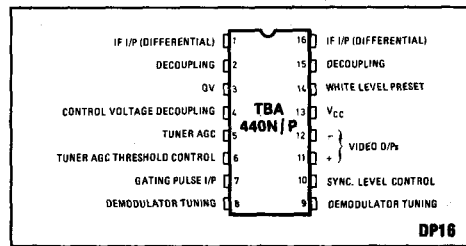

Fig. 1 Pin connections

FEATURES

- Complete Video IF in one IC
- High Sensitivity
- Positive and Negative Video Signals
- Gated AGC and Delayed AGC for Tuner
- White and Black Levels Separately Adjustable
- Ability to Control PIN Diode Attenuators

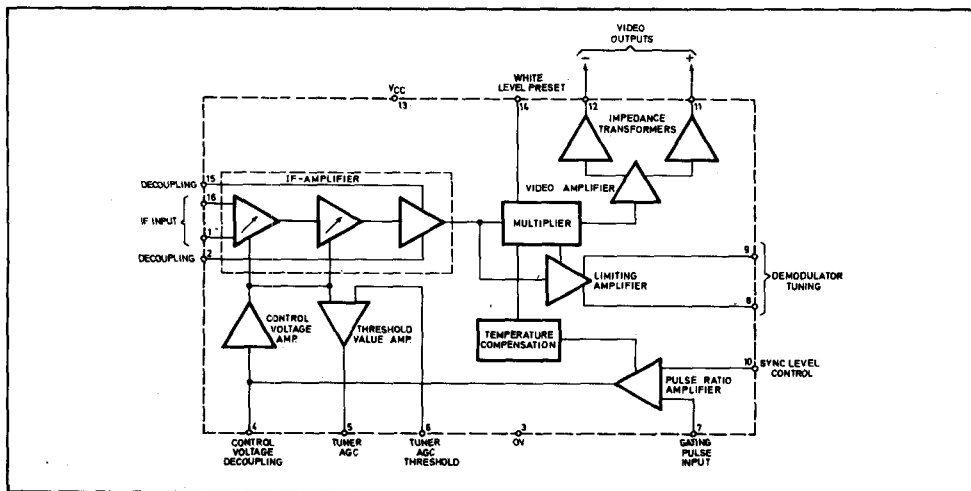

Fig. 2 TBA440 block diagram

TBA440N / TBA440P

ELECTRICAL CHARACTERISTICS

Test Conditions (unless otherwise stated):

$T_{amb} = +25^{\circ}C$
 $V_{CC} = +13V$
 Reference point is pin 3 (0V)

Characteristic	Pin	Value			Units	Conditions
		Min.	Typ.	Max.		
Supply voltage, V_{CC}	13	10.5	13	15	V	
Current consumption	13	28	40	52	mA	$V_{CC} = 15V$
DC output voltage	11	4.1	5.1	6.1	V	$V_{in} = 0V, R_{14} = \infty$
	11		6.2		V	$V_{in} = 0V, R_{14} = 0$
	12	0.5	1.1	1.8	V	$V_{in} = 0V, R_{14} = \infty$
	12		2.5		V	$V_{in} = 0V, R_{14} = 0$
White level deviation						
$\Delta V_{11}/\Delta V_{13}$	11, 13		0.15			
$\Delta V_{12}/\Delta V_{13}$	12, 13		0.05			
Resistance R_{14-3} for $\Delta V_{11} = 1V$	14, 3		1		k Ω	
AGC threshold $V_{10} = \text{sync pulse level for } R_{10-11} = 0$	10, 11		1.2		V	$V_{10} = V_{11}$
Regulating slope R_{10-11}/V_{11}	10, 11		4.5		k Ω/V	
Sync. pulse level with async. or without gating pulses	11		0.2		V	
Control current for tuner pre amp.	5	10	15		mA	$V_5 > 2V, 10dB \text{ after AGC (TBA440P)}$ $10dB \text{ before AGC (TBA440N)}$
IF control voltage for max gain	4	0		0.5	V	
for min gain	4	2.5		5	V	
Gating pulse voltage	7	-2		-5	V	
Residual IF voltage	11, 12		50		mV	
Output current to earth	11, 12			5	mA	
Output current to V_{13}	11, 12			-1	mA	
Input impedance at max gain	1		1.8/2		k Ω/pF	
at min gain	1		1.9/0		k Ω/pF	
Input voltage for $V_{11} = 3V$ p-p	1		100		μV	Input 60 Ω via 3:5 transformer
Video bandwidth			7		MHz	
AGC range		52	58		dB	
Intermodulation			55		dB	Input 0.3 to 1.5V p-p

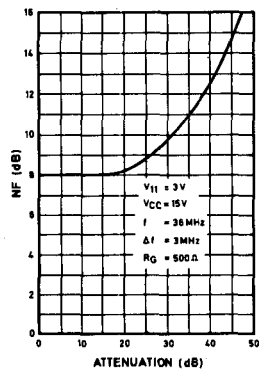

Fig. 3 Noise figure v. attenuation (measured at video frequency)

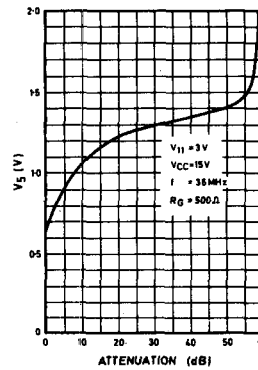

Fig. 4 Control voltage v. attenuation

TBA440N / TBA440P

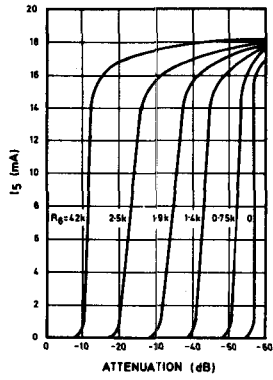

Fig. 5 Tuner control current v. attenuation with R_G as parameter (TBA440P)

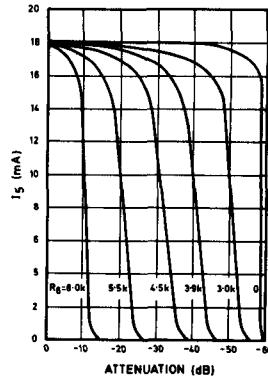

Fig. 6 Tuner control current v. attenuation with R_G as parameter (TBA440N)

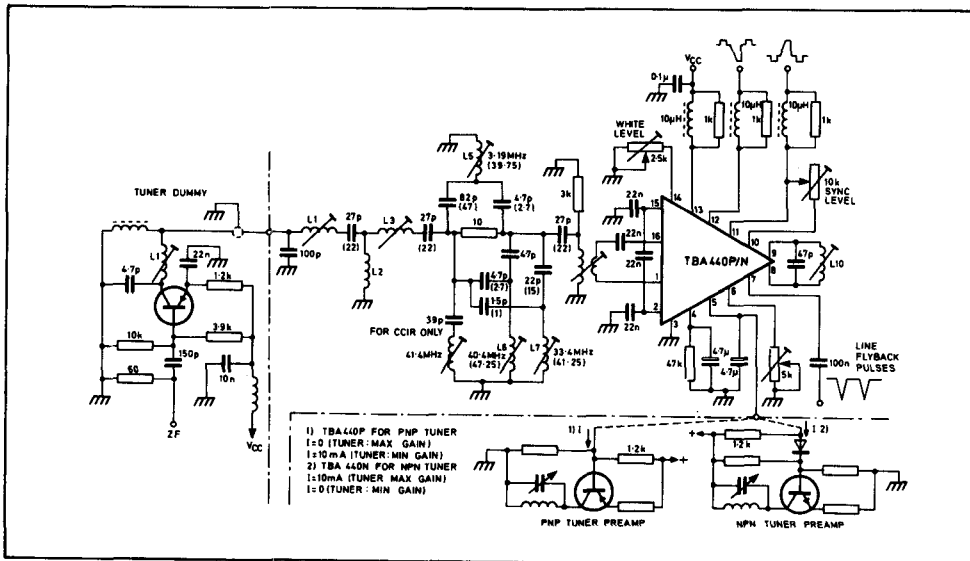

Fig. 7 IF application with TBA440P or TBA440N for CCIR standard (values in brackets for U.S. standard)