

TBA 625A

LINEAR INTEGRATED CIRCUIT

VOLTAGE REGULATOR

- OUTPUT CURRENT ≥ 100 mA
- TIGHT TOLERANCE for OUTPUT VOLTAGE
- LOAD REGULATION $\leq 1\%$
- RIPPLE REJECTION 60 dB TYPICAL
- OVERLOAD and SHORT CIRCUIT PROTECTION

The TBA 625A is an integrated monolithic 5 V voltage regulator in TO-39 metal case which can supply more than 100 mA. The device features high temperature stability, internal overload and short circuit protection, low output impedance and excellent transient response. The TBA 625A is intended for use as voltage supply for digital circuits and for any other industrial application.

ABSOLUTE MAXIMUM RATINGS

V_i	Input voltage	20 V
P_{tot}	Power dissipation at $T_{amb} = 25^\circ\text{C}$	0.75 W
	at $T_{case} = 25^\circ\text{C}$	4 W
T_{stg}	Storage temperature	-55 to 150 $^\circ\text{C}$
T_j	Junction temperature	175 $^\circ\text{C}$
T_{op}	Operating temperature	0 to 70 $^\circ\text{C}$

ORDERING NUMBER: TBA 625A X5

MECHANICAL DATA

Dimensions in mm

Ground connected to case

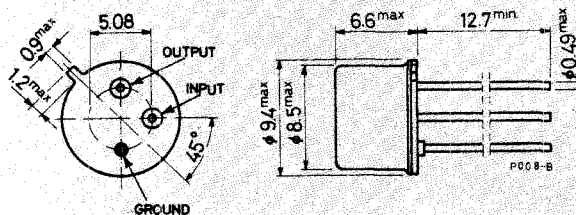

TBA 625A

SCHEMATIC DIAGRAM

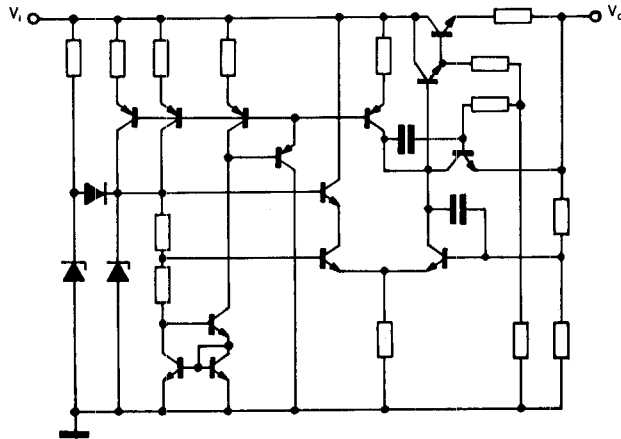

THERMAL DATA

$R_{th\ j-case}$	Thermal resistance junction-case	max	37.5	°C/W
$R_{th\ j-amb}$	Thermal resistance junction-ambient	max	200	°C/W

ELECTRICAL CHARACTERISTICS ($T_j = 25\text{ °C}$ unless otherwise specified)

Parameter	Test conditions	Min.	Typ.	Max.	Unit
V_o Output voltage	$V_i = 8\text{ V to } 20\text{ V}$ $I_o = 5\text{ mA}$ $C_L = 10\text{ }\mu\text{F}$	4.75	5	5.25	V
$\frac{\Delta V_o}{V_o}$ Load regulation	$V_i = 8\text{ V to } 20\text{ V}$ $I_o = 5\text{ mA to } 100\text{ mA}$ $C_L = 10\text{ }\mu\text{F}$		0.3	1	%
I_o Regulated current	$V_i = 12\text{ V}$ $\frac{\Delta V_o}{V_o} \leq 1\%$	100	140		mA

TBA 625A

ELECTRICAL CHARACTERISTICS (continued)

Parameter		Test conditions	Min.	Typ.	Max.	Unit
I_o	Max. regulated current	$V_i = 12\text{ V}$	130	150	200	mA
R_o	Output resistance	$V_i = 12\text{ V}$ $I_o = 5\text{ mA to }100\text{ mA}$		0.1		Ω
$\frac{\Delta V_o}{V_o}$	Line regulation	$V_i = 8\text{ V to }20\text{ V}$ $I_o = 5\text{ mA}$ $C_L = 10\ \mu\text{F}$		0.2	1	%
SVR	Supply voltage rejection	$V_i = 10\text{ V}$ $\Delta V_i = 4\text{ V}_{pp}$ $I_o = 5\text{ mA}$ $C_L = 10\ \mu\text{F}$ $f = 100\text{ Hz}$	46	60		dB
e_N	Output noise voltage	$V_i = 12\text{ V}$ $I_o = 5\text{ mA}$ $C_L = 10\ \mu\text{F}$ $B = 10\text{ Hz to }100\text{ kHz}$		70		μV
I_d	Quiescent drain current	$V_i = 20\text{ V}$ $I_o = 0$	5	9	16	mA
$\frac{\Delta V_o}{\Delta T_{amb}}$	Temperature coefficient	$V_i = 12\text{ V}$ $I_o = 5\text{ mA}$ $C_L = 10\ \mu\text{F}$ $T_{amb} = 0\text{ to }70\text{ }^\circ\text{C}$		0.5		mV/ $^\circ\text{C}$
I_{sc}	Output short circuit current	$V_i = 20\text{ V}$ $V_o = 0$		45	65	mA

TBA 625A

Fig. 1 - Typical output voltage vs output current

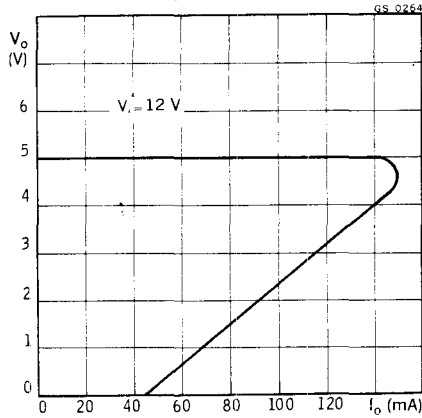

Fig. 2 - Power rating chart

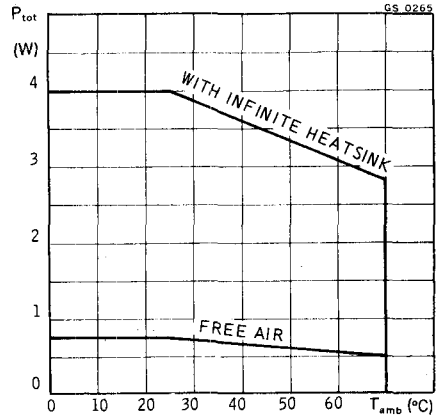

Fig. 3 - Maximum output current vs junction temperature

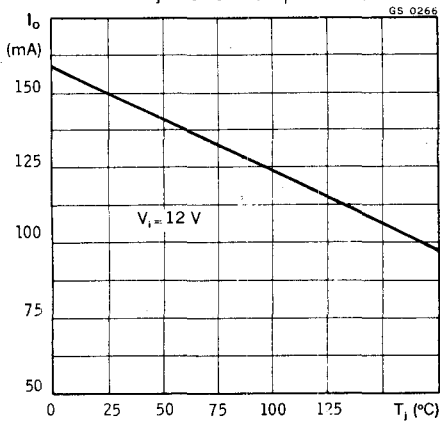

Fig. 4 - Typical ripple rejection vs regulated output current

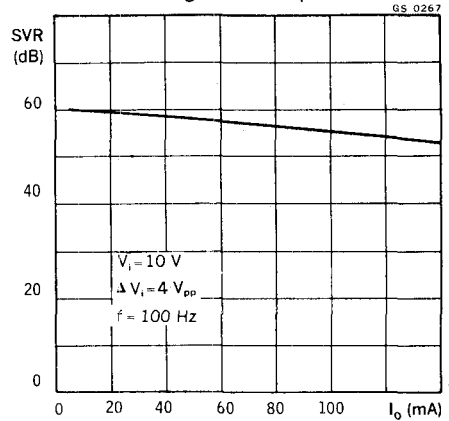

Fig. 5 - Typical ripple rejection vs frequency

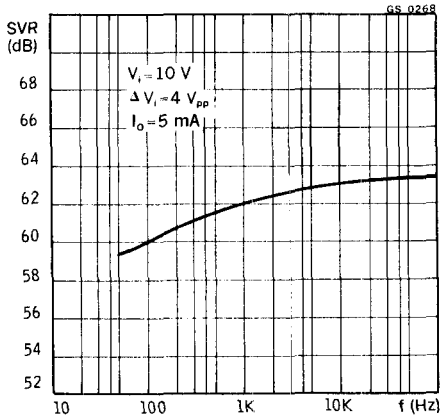

Fig. 6 - Maximum output current vs input voltage

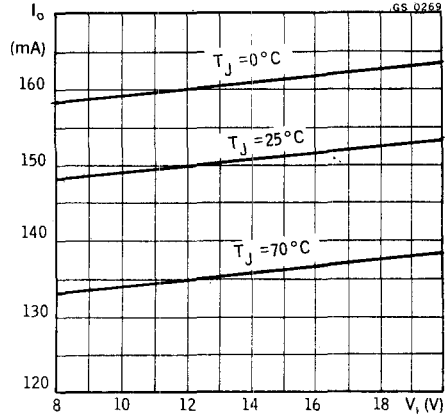

Fig. 7 - Typical short circuit output current vs input voltage

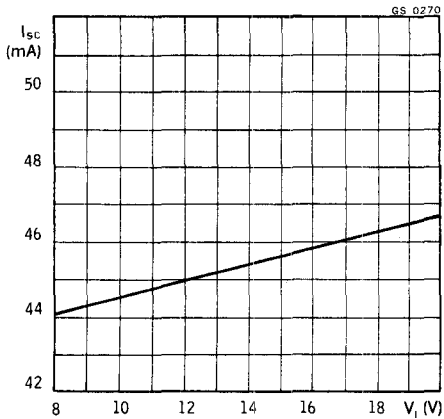
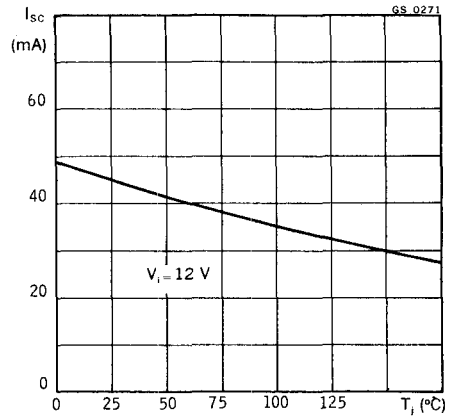

Fig. 8 - Typical short circuit output current vs junction temperature



TBA 625A

Fig. 9 - Typical dropout voltage vs output current

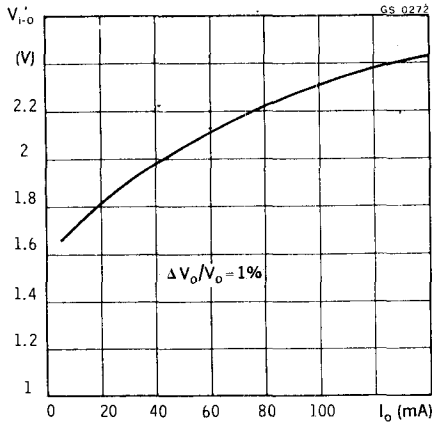

Fig. 10 - Typical quiescent drain current vs junction temperature

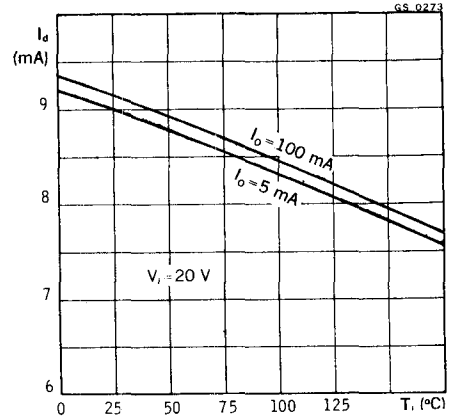

Fig. 11 - Typical quiescent drain current vs input voltage

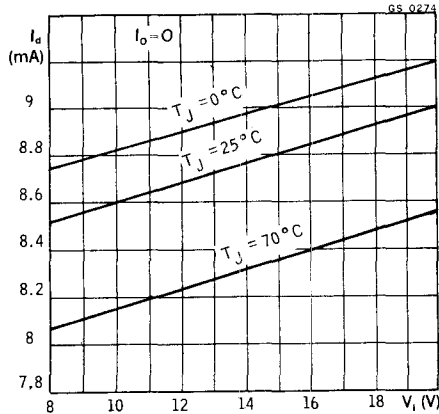
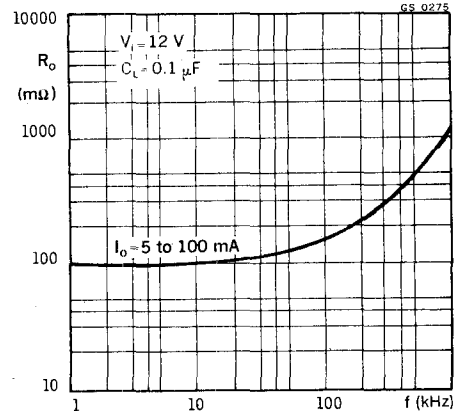
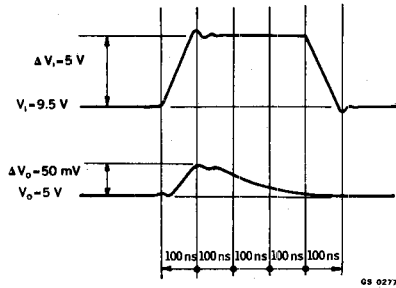

Fig. 12 - Typical output resistance vs frequency



TBA 625A

Line transient response
($I_o = 5 \text{ mA}$)



Turn-on time
($I_o = 100 \text{ mA}$)

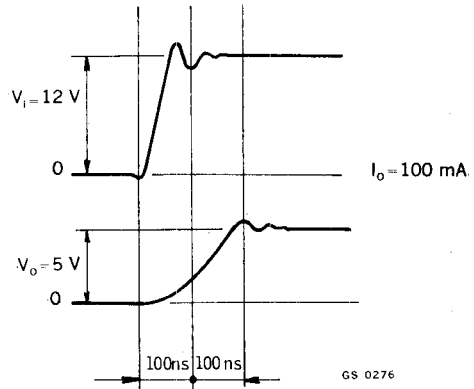

TYPICAL APPLICATIONS

Fig. 13 - Positive output voltage regulator

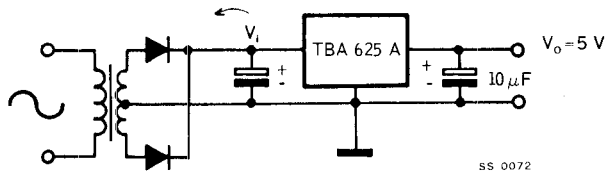
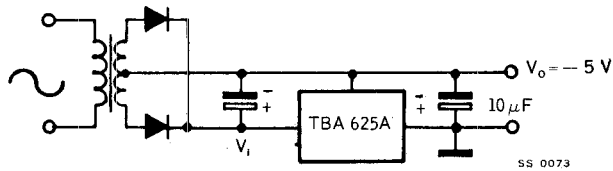
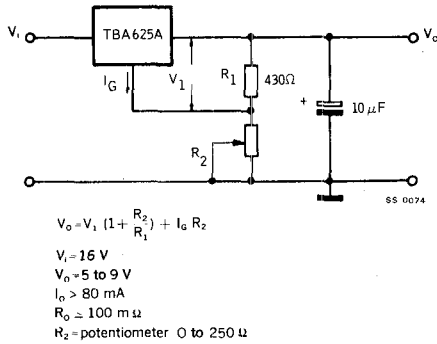

Fig. 14 - Negative output voltage regulator



TBA 625A

Fig. 15 - Adjustable output voltage regulator



Typical adjustable output voltage vs output current

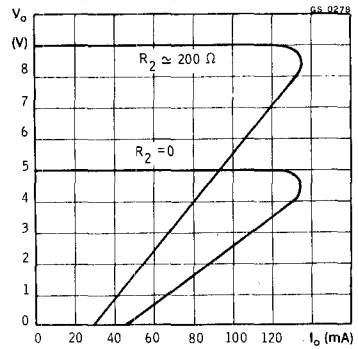
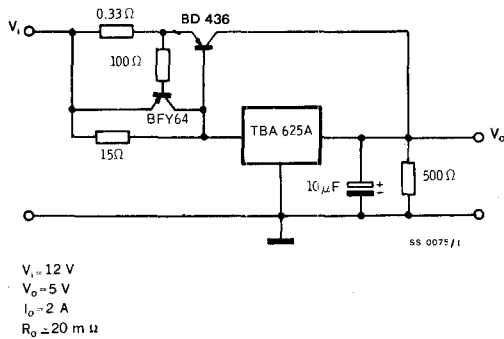

Fig. 16 - PNP current boost circuit



Typical output voltage vs output current

