

## LINEAR INTEGRATED CIRCUIT

### VOLTAGE REGULATOR

- OUTPUT CURRENT  $\cong 100$  mA
- TIGHT TOLERANCE for OUTPUT VOLTAGE
- LOAD REGULATION  $\leq 1\%$
- RIPPLE REJECTION 54 dB TYPICAL
- OVERLOAD and SHORT CIRCUIT PROTECTION

The TBA 625B is an integrated monolithic 12 V voltage regulator in TO-39 metal case which can supply more than 100 mA. The device features high temperature stability, internal overload and short circuit protection, low output impedance and excellent transient response. The TBA 625B is intended for use as voltage supply for digital circuits with high noise immunity, linear integrated circuits and for any other industrial applications.

### ABSOLUTE MAXIMUM RATINGS

$V_i$	Input voltage	27	V
$P_{tot}$	Power dissipation at $T_{amb} = 25^\circ\text{C}$	0.75	W
	at $T_{case} = 25^\circ\text{C}$	4	W
$T_{stg}$	Storage temperature	-55 to 150	$^\circ\text{C}$
$T_j$	Junction temperature	175	$^\circ\text{C}$
$T_{op}$	Operating temperature	0 to 70	$^\circ\text{C}$

ORDERING NUMBER: TBA 625B X5

### MECHANICAL DATA

Dimensions in mm

Ground connected to case

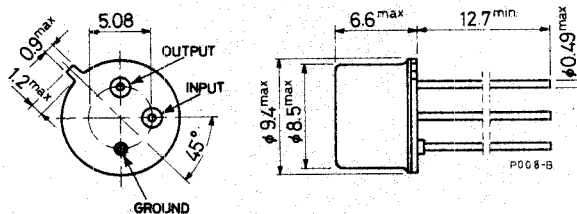

# TBA 625B

## SCHEMATIC DIAGRAM

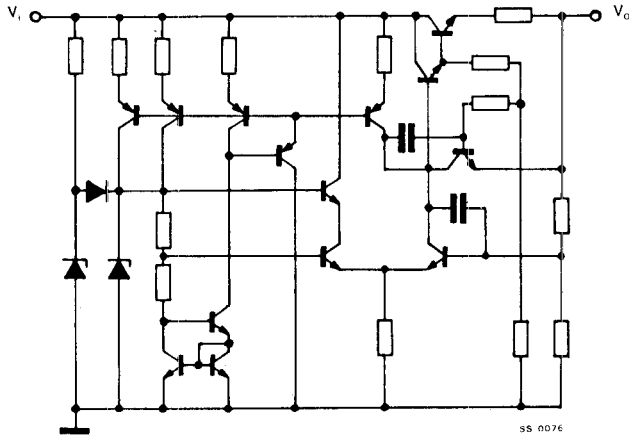

## THERMAL DATA

$R_{th\ j-case}$	Thermal resistance junction-case	max	37.5	°C/W
$R_{th\ j-amb}$	Thermal resistance junction-ambient	max	200	°C/W

## ELECTRICAL CHARACTERISTICS $(T_j = 25\text{ °C unless otherwise specified})$

Parameter	Test conditions	Min.	Typ.	Max.	Unit
$V_o$ Output voltage	$V_i = 15\text{ V to }27\text{ V}$ $I_o = 5\text{ mA}$ $C_L = 10\text{ }\mu\text{F}$	11.4	12	12.6	V
$\frac{\Delta V_o}{V_o}$ Load regulation coefficient	$V_i = 15\text{ V to }27\text{ V}$ $I_o = 5\text{ mA to }100\text{ mA}$ $C_L = 10\text{ }\mu\text{F}$		0.3	1	%
$I_o$ Regulated current	$V_i = 12\text{ V}$ $\frac{\Delta V_o}{V_o} \leq 1\%$	100	140		mA

## ELECTRICAL CHARACTERISTICS (continued)

Parameter		Test conditions	Min.	Typ.	Max.	Unit
$I_o$	Max. regulated current	$V_i = 21 \text{ V}$	120	150	200	mA
$R_o$	Output resistance	$V_i = 21 \text{ V}$ $I_o = 5 \text{ mA to } 100 \text{ mA}$		0.1		$\Omega$
$\frac{\Delta V_o}{V_o}$	Line regulation coefficient	$V_i = 15 \text{ V to } 27 \text{ V}$ $I_o = 5 \text{ mA}$ $C_L = 10 \mu\text{F}$		0.2	0.5	%
SVR	Supply voltage rejection	$V_i = 17 \text{ V}$ $\Delta V_i = 4 \text{ V}_{pp}$ $I_o = 5 \text{ mA}$ $C_L = 10 \mu\text{F}$ $f = 100 \text{ Hz}$		46	54	dB
$e_N$	Output noise voltage	$V_i = 21 \text{ V}$ $I_o = 5 \text{ mA}$ $C_L = 10 \mu\text{F}$ $B = 10 \text{ Hz to } 100 \text{ kHz}$		150		$\mu\text{V}$
$I_d$	Quiescent drain current	$V_i = 27 \text{ V}$ $I_o = 0$	6	10	18	mA
$\frac{\Delta V_o}{\Delta T_{amb}}$	Voltage/temperature coefficient	$V_i = 21 \text{ V}$ $I_o = 5 \text{ mA}$ $C_L = 10 \mu\text{F}$ $T_{amb} = 0 \text{ to } 70 \text{ }^\circ\text{C}$		0.85		mV/ $^\circ\text{C}$
$I_{sc}$	Output short circuit current	$V_i = 27 \text{ V}$ $V_o = 0$		35	55	mA

# TBA 625B

Fig. 1 - Typical output voltage vs output current

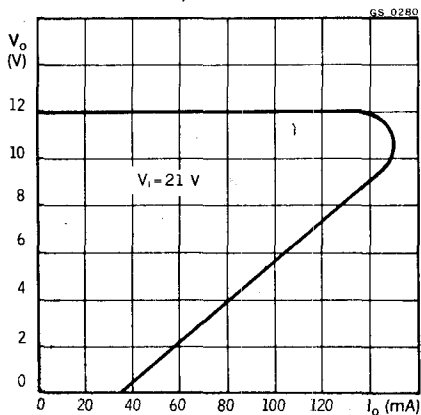

Fig. 2 - Power rating chart

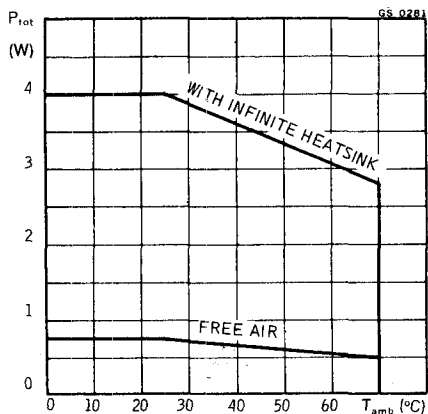

Fig. 3 - Maximum output current vs junction temperature

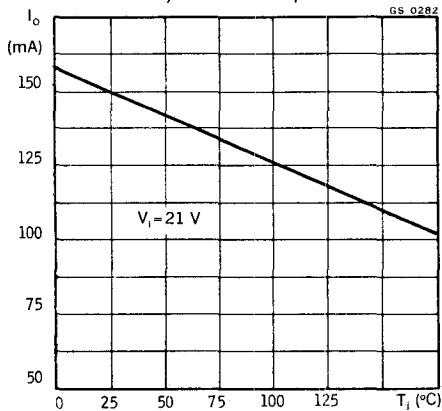
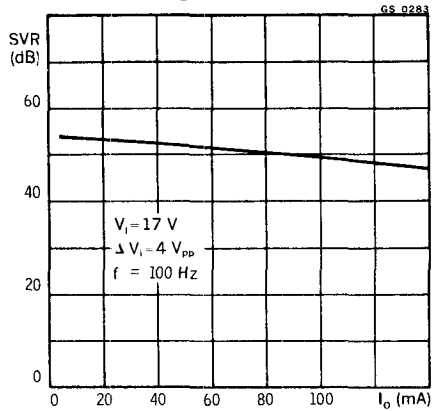

Fig. 4 - Typical ripple rejection vs regulated output current



# TBA 625B

Fig. 5 - Typical ripple rejection vs frequency

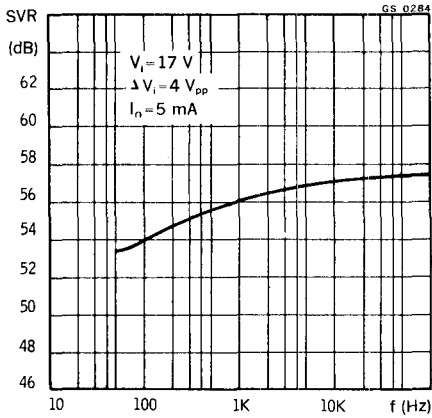

Fig. 6 - Maximum output current vs input voltage

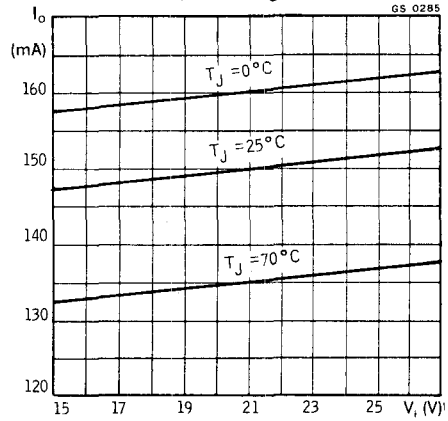

Fig. 7 - Typical short circuit output current vs input voltage

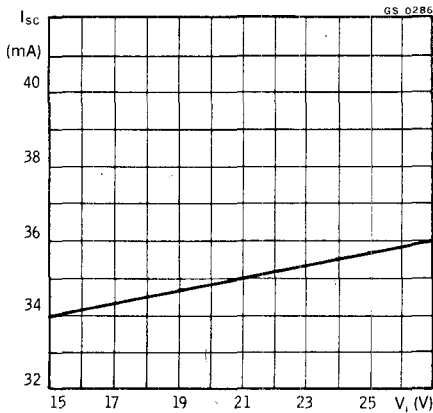
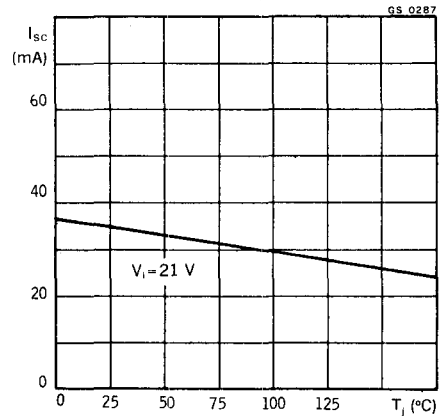

Fig. 8 - Typical short circuit output current vs junction temperature



# TBA 625B

Fig. 9 - Typical dropout voltage vs output current

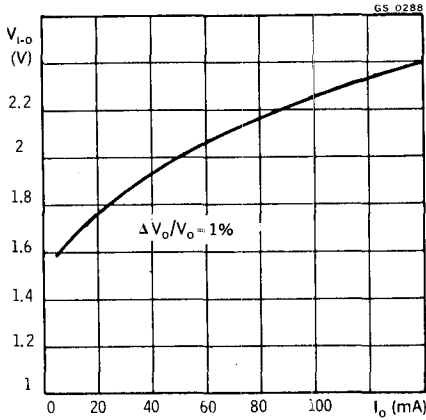

Fig. 10 - Typical quiescent drain current vs junction temperature

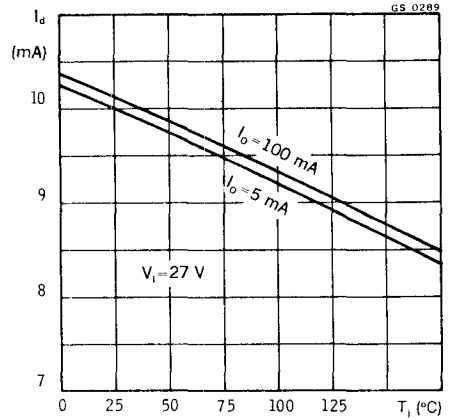

Fig. 11 - Typical quiescent drain current vs input voltage

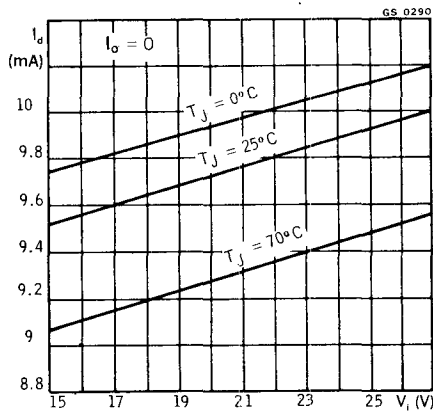
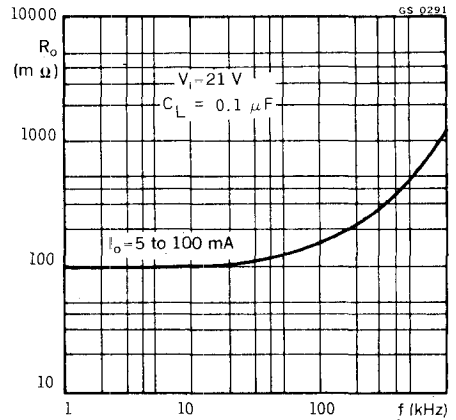
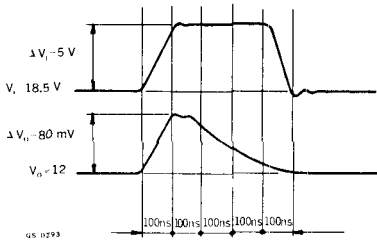

Fig. 12 - Typical output resistance vs frequency



# TBA 625B

Line transient response  
( $I_o = 5 \text{ mA}$ )



Turn-on time  
( $I_o = 100 \text{ mA}$ )

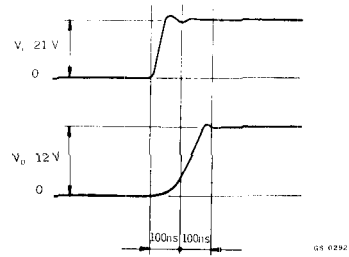

## TYPICAL APPLICATIONS

Fig. 13 - Positive output voltage regulator

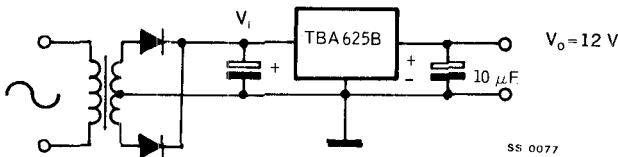
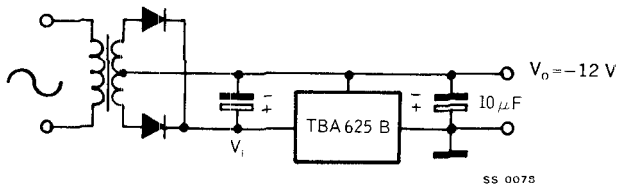
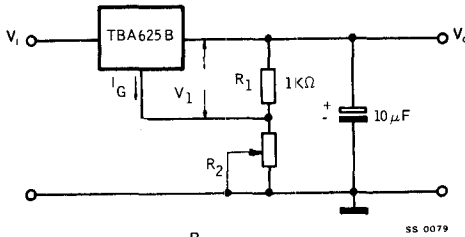

Fig. 14 - Negative output voltage regulator



# TBA 625B

Fig. 15 - Adjustable output voltage regulator



$$V_o = V_1 \left(1 + \frac{R_2}{R_1}\right) + I_G R_2$$

$V_1 = 24 \text{ V}$   
 $V_o = 12 \text{ to } 15 \text{ V}$   
 $I_G > 80 \text{ mA}$   
 $R_1 \approx 100 \text{ m}\Omega$   
 $R_2 = \text{potentiometer } 0 \text{ to } 150 \Omega$

Typical adjustable output voltage vs output current

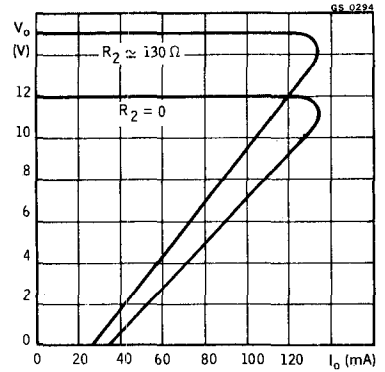
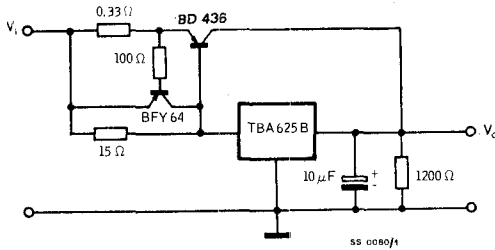

Fig. 16 - PNP current boost circuit



$V_i = 21 \text{ V}$   
 $V_o = 12 \text{ V}$   
 $I_o = 2 \text{ A}$   
 $R_o \approx 20 \text{ m}\Omega$

Typical output voltage vs output current

