



# TBA 810 S · TBA 810 AS

## Monolithisch Integrierte Schaltung Monolithic Integrated Circuit

Anwendung: NF-Leistungsverstärker  
Application: Audio power amplifier

### Besondere Merkmale:

- Thermische Abschaltung
- Hoher Ausgangsstrom bis 2,5 A
- Großer Versorgungsspannungsbereich, 4 bis 20 V
- Hohe Ausgangsleistung, 7 W
- Kleine Übernahmeverzerrungen
- Kleiner Klirrfaktor
- Sehr guter Wirkungsgrad, 70%

### Features:

- Thermal shut-down
- High output current, up to 2.5 A
- Wide range of supply voltage, 4 to 20 V
- High output power 7 W
- Low harmonic distortion
- Low cross overdistortion
- Very high efficiency 70%

### Vorläufige technische Daten · Preliminary specifications

Abmessungen in mm  
Dimensions in mm

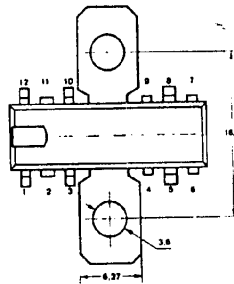
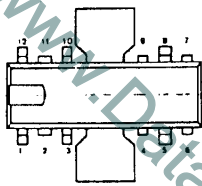
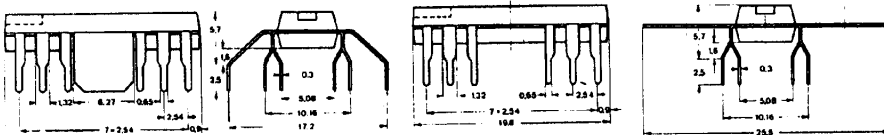

Spezialgehäuse  
Kunststoff  
Special case  
Plastic  
Gewicht · Weight  
max. 1,5 g

TBA 810 S

TBA 810 AS

# TBA 810 S · TBA 810 AS

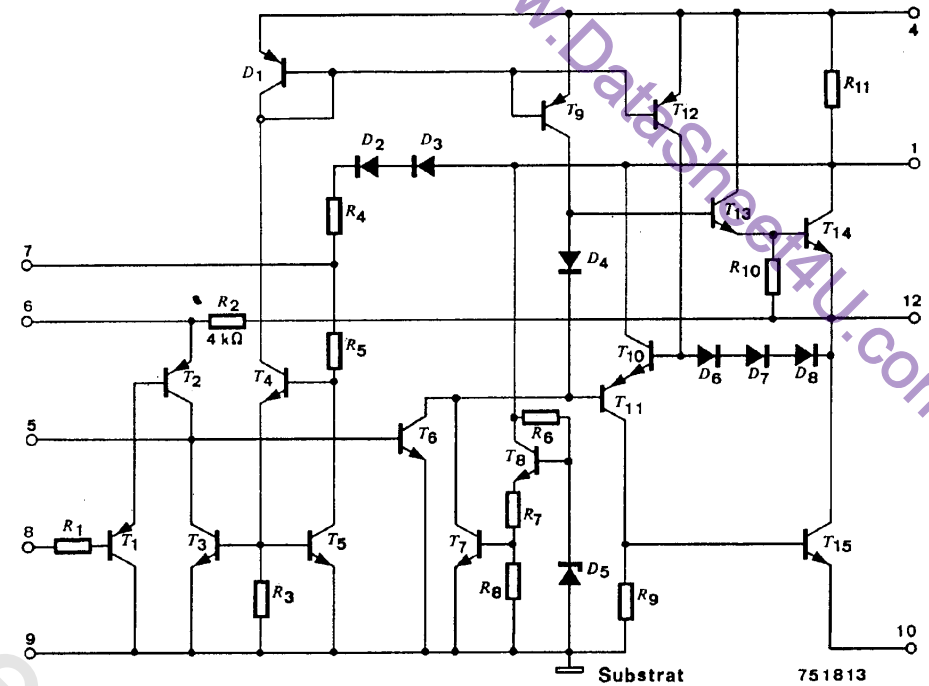

Fig. 1 Schaltung und Anschlußbelegung  
Diagram and pin connections

### Absolute Grenzwerte Absolute maximum ratings

Bezugspunkt Pin 9, Pin 10  
Reference point

Versorgungsspannung Supply voltage	Pin 1	$U_S$	20	V
Ausgangsstoßstrom Surge output current	Pin 12	$I_{QS}$	3,5	A
Ausgangsspitzenstrom Peak output current (repetitive)	Pin 12	$I_{QM}$	2,5	A
Verlustleistung Power dissipation	Fig. 2, 3, 4, 5, 6			
$t_{amb} = 80^\circ\text{C}$	<b>TBA 810 S</b>	$P_{tot}$	1	W
$t_{case} = 100^\circ\text{C}$	<b>TBA 810 AS</b>	$P_{tot}$	5	W
Sperrschichttemperatur Junction temperature		$t_j$	+150	$^\circ\text{C}$
Lagerungstemperaturbereich Storage temperature range		$t_{stg}$	-40 ... +150	$^\circ\text{C}$

# TBA 810 S · TBA 810 AS

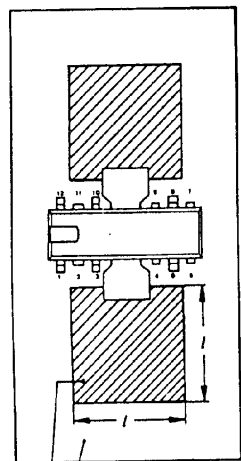
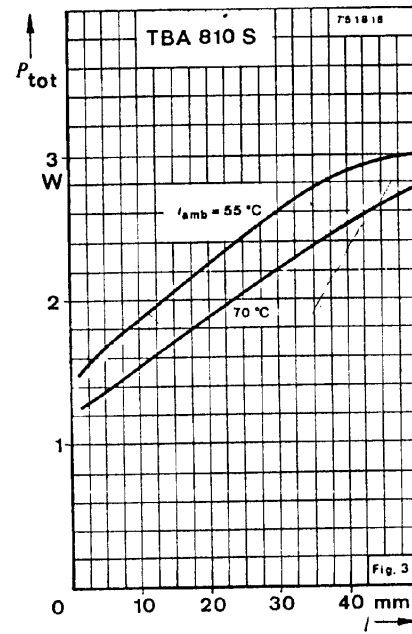
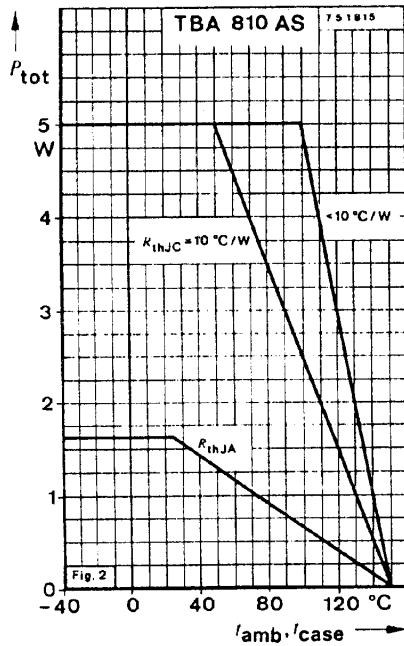

Kupferfläche 35  $\mu\text{m}$  dick  
Copper area 35  $\mu\text{m}$  thickness

Fig. 4

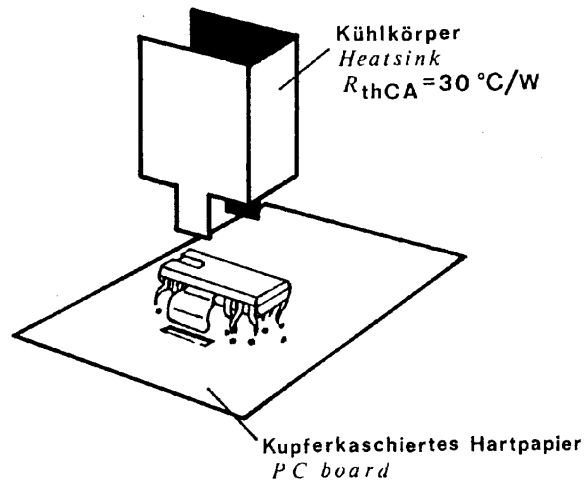

Fig. 5

# TBA 810 S · TBA 810 AS

## Wärmewiderstände Thermal resistances

		Min.	Typ.	Max.
Sperrschicht-Umgebung Junction ambient	<b>TBA 810 S</b> <b>TBA 810 AS</b>	$R_{thJA}$		70 $^\circ\text{C/W}$ 80 $^\circ\text{C/W}$
Sperrschicht-Gehäuse Fig. 3, 4, 5 Junction case Fig. 2	<b>TBA 810 S</b> <b>TBA 810 AS</b>	$R_{thJC}^{1)}$ $R_{thJC}^{1)}$		12 $^\circ\text{C/W}$ 10 $^\circ\text{C/W}$

## Elektrische Kenngrößen Electrical characteristics

$t_{amb} = 25 \text{ }^\circ\text{C}$ ,  $R_f = 56 \text{ } \Omega$ , Bezugspunkt: Pin 9, Pin 10 falls nicht anders angegeben  
Reference point: unless otherwise specified

Versorgungsspannung Supply voltage	Pin 1	$U_S$	4	20	V		
Mittenspannung Quiescent output voltage $U_S = 14,4 \text{ V}$	Fig. 13	Pin 12	$U_{QB}$	6,4	7,2	8	V
Ruhestrom der Gesamtschaltung Quiescent drain current $U_S = 14,4 \text{ V}$	Fig. 12	Pin 1	$I_{SB}$	12	20	mA	
Gesamtstromaufnahme Total supply current $P_q = 6 \text{ W}$ , $U_S = 14,4 \text{ V}$ , $R_L = 4 \text{ } \Omega$		Pin 1	$I_{S \text{ tot}}$	600		mA	
Thermische Abschalttemperatur Thermal shut-down temperature $P_{tot} = 2,8 \text{ W}$	Fig. 11		$t_{case}$	120		$^\circ\text{C}$	
Brummunterdrückung Supply voltage rejection ratio $U_S = 14,4 \text{ V}$ , $R_L = 4 \text{ } \Omega$ , $f_{Br} = 100 \text{ Hz}$	Fig. 14, 15		$k_{SVR}$	48		dB	
Eingangsstrom Input current $U_S = 14,4 \text{ V}$		Pin 8	$I_{IB}$	0,4	4	$\mu\text{A}$	
Ausgangsleistung Output power $R_L = 4 \text{ } \Omega$ , $f = 1 \text{ kHz}$ , $k = 10\%$	Fig. 6, 8, 9, 10, 11		$P_q$	7		W	
			$P_q$	6		W	
			$P_q$	2,5		W	
			$P_q$	1		W	
Eingangsspannung Input voltage		Pin 8	$U_i$	220		mV	
Eingangsspannung Input voltage $U_S = 14,4 \text{ V}$ , $P_q = 6 \text{ W}$ , $f = 1 \text{ kHz}$ , $R_L = 4 \text{ } \Omega$	Fig. 18	Pin 8	$U_i$	80		mV	
			$U_i$	35		mV	

<sup>1)</sup> mit Kühlfläche  $R_{thCA} = 10 \text{ }^\circ\text{C/W}$   
with cooling plate

# TBA 810 S · TBA 810 AS

			Min.	Typ.	Max.	
Eingangswiderstand Input resistance	Pin 8	$R_i$		5		M $\Omega$
Bandbreite (-3 dB) Band width	Fig. 16	$B$	40 ...	20000		Hz
$U_S = 14,4 \text{ V}, R_L = 4 \Omega, C_3 = 820 \text{ pF}$ $C_3 = 1500 \text{ pF}$		$B$	40 ...	10000		Hz
Klirrfaktor Distortion	Fig. 6, 19, 20	$k$		0,3		%
$U_S = 14,4 \text{ V}, R_L = 4 \Omega,$ $f = 1 \text{ kHz}, P_q = 50 \text{ mW bis/to } 3 \text{ W}$						
Spannungsverstärkungen Voltage amplifications						
$U_S = 14,4 \text{ V}, R_L = 4 \Omega, f = 1 \text{ kHz}$						
Leerlauf Open loop		$A_{Ug}$		80		dB
mit Gegenkopplung closed loop	Fig. 17	$A_{Uf}$	34	37	40	dB
Eingangsrauschspannung Input noise voltage						
$U_S = 14,4 \text{ V}, B = 20 \dots 20000 \text{ Hz}$	Pin 8	$U_{ni}$		2		$\mu\text{V}$
Eingangsrauschstrom Input noise current						
$U_S = 14,4 \text{ V}, B = 20 \dots 20000 \text{ Hz}$	Pin 8	$I_{ni}$		0,1		nA
Wirkungsgrad Efficiency	Fig. 6, 9	$\eta$		70		%
$P_q = 5 \text{ W}, U_S = 14,4 \text{ V},$ $R_L = 4 \Omega, f = 1 \text{ kHz}$						

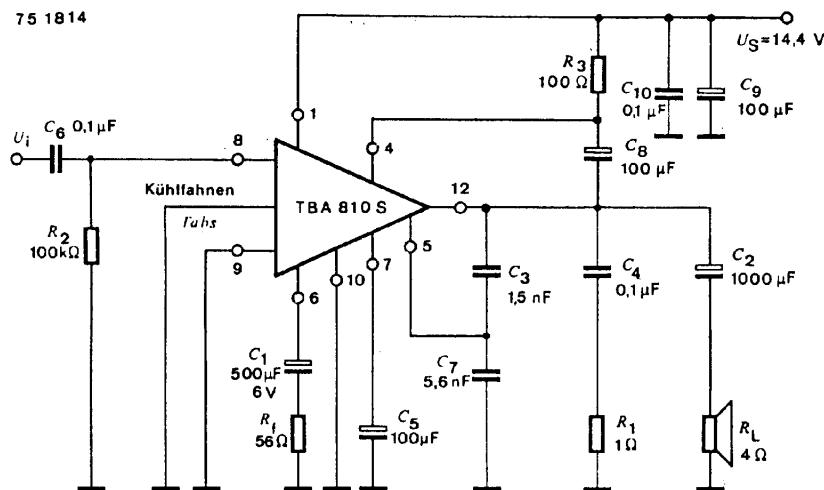
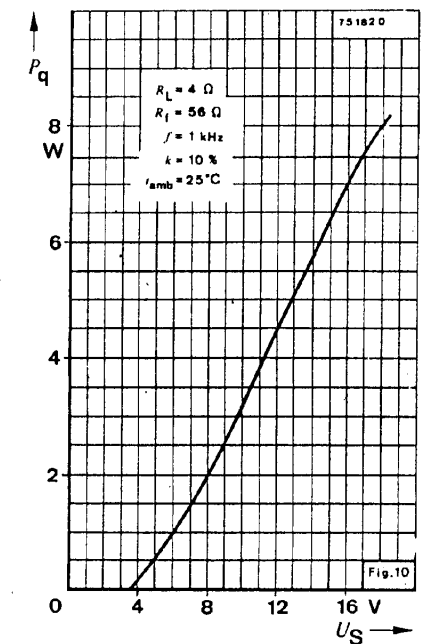
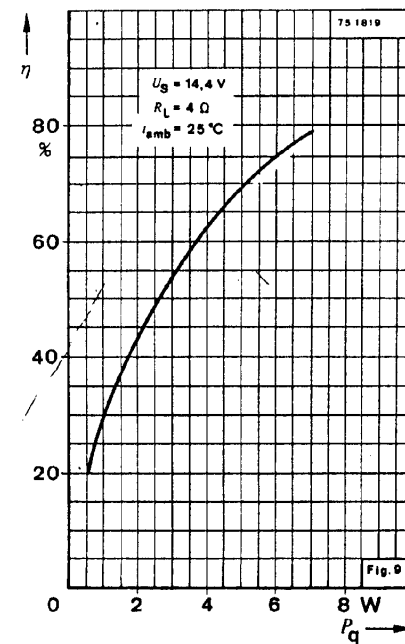
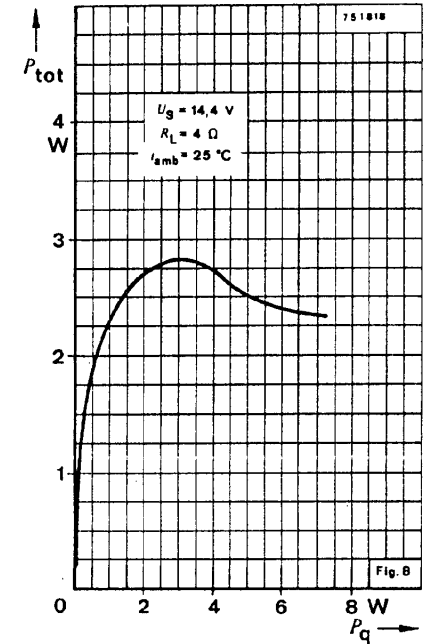
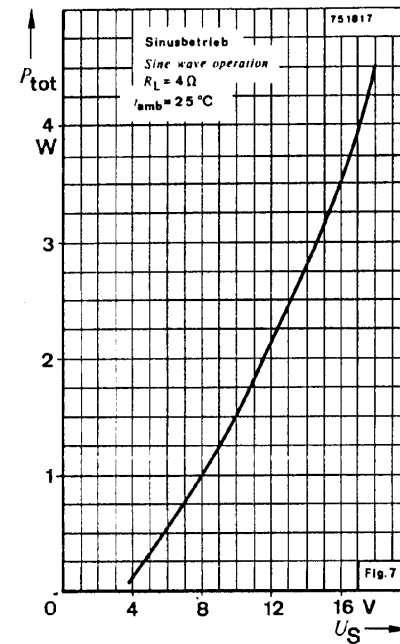
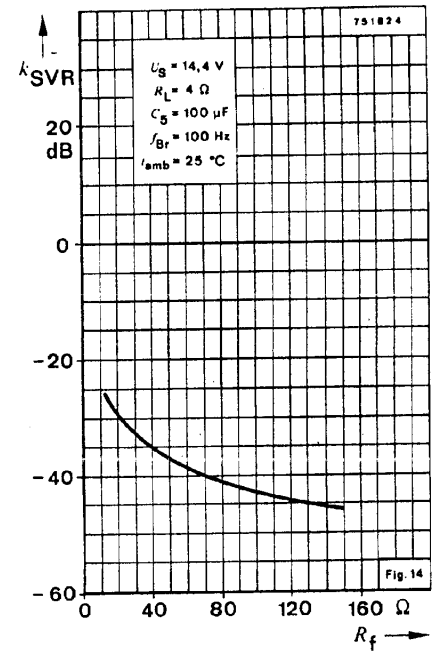
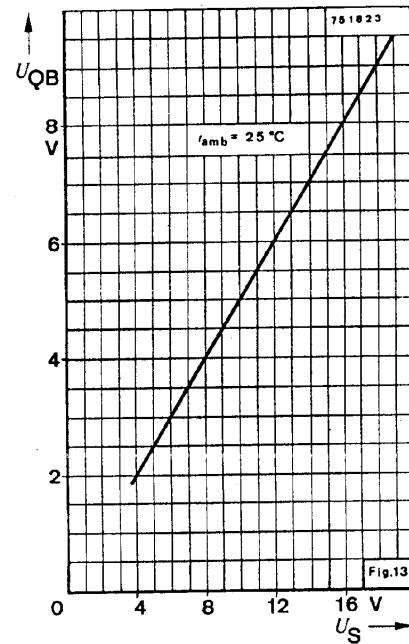
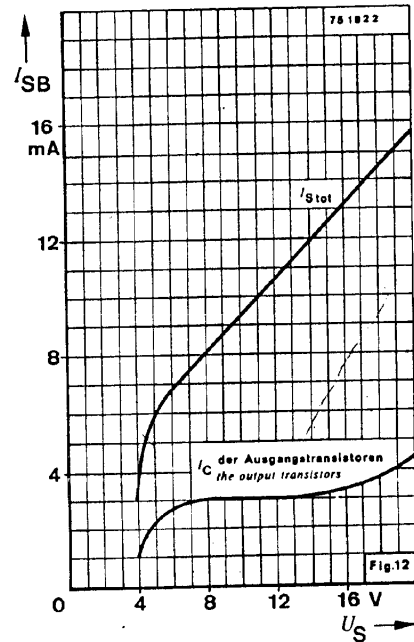
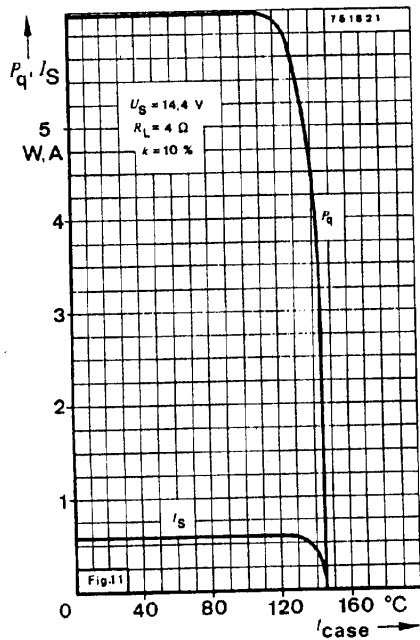

Fig. 6 Meßschaltung für:  $P_q, P_{tot}, k, \eta$  und Anwendungsbeispiel  
Test circuit for: and application note

# TBA 810 S · TBA 810 AS





### Thermisches Abschalten:

Die eingebaute thermische Begrenzerschaltung ergibt folgende Vorteile:

1. Eine dauernde Überlastung des Ausgangs oder eine Erhöhung der zulässigen oberen Umgebungstemperatur kann einfach verhindert werden.
2. Die Kühlung kann gegenüber konventionellen Schaltungen mit einem kleineren Sicherheitsfaktor ausgelegt werden. Bei einer thermischen Überlastung wird der Schaltkreis nicht infolge einer zu hohen Sperrschichttemperatur zerstört, denn es wird ausschließlich  $P_Q$  (und somit  $P_{Tot}$ ) und  $I_S$  reduziert (siehe Fig. 11).

### Thermal shut-down

The presence of a thermal limiting circuit offers the following advantages:

1. An overload on the output (even if it is permanent), or an above-limit ambient temperature can be easily supported.
2. The heat sink can have a smaller factor of safety compared with that of a conventional circuit. There is no device damage in the case of too high a junction temperature: all that happens is that  $P_Q$  (and therefor  $P_{Tot}$ ) and  $I_S$  are reduced (fig. 11).

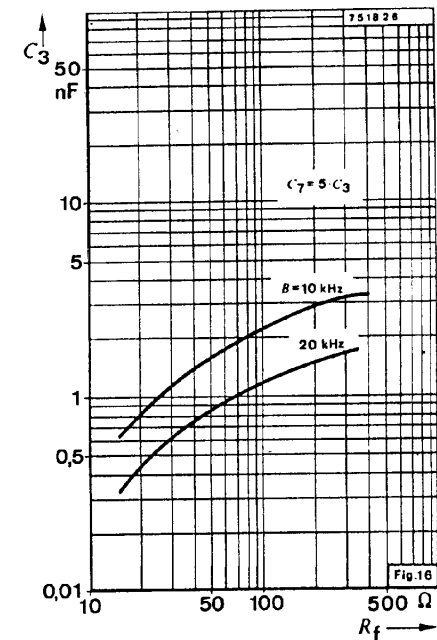
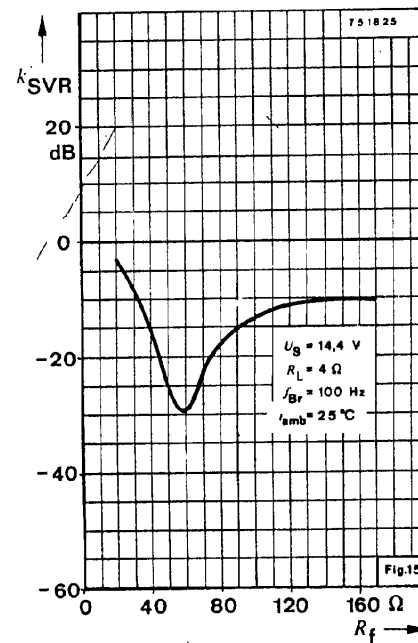

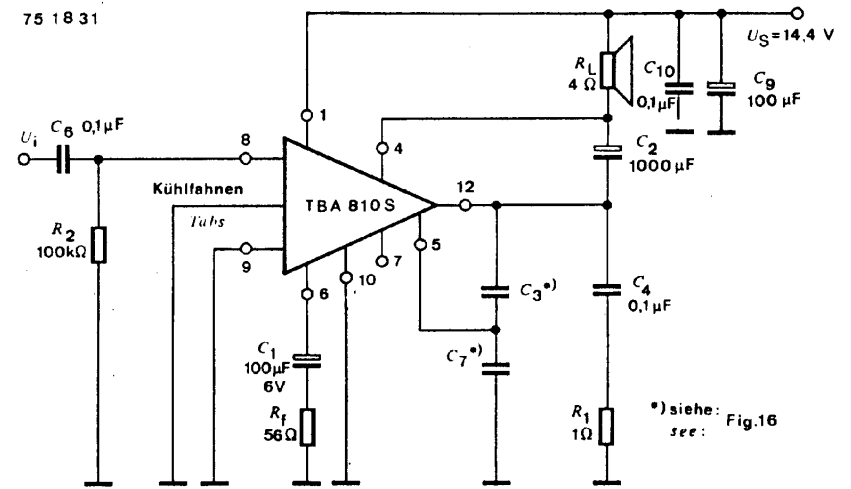
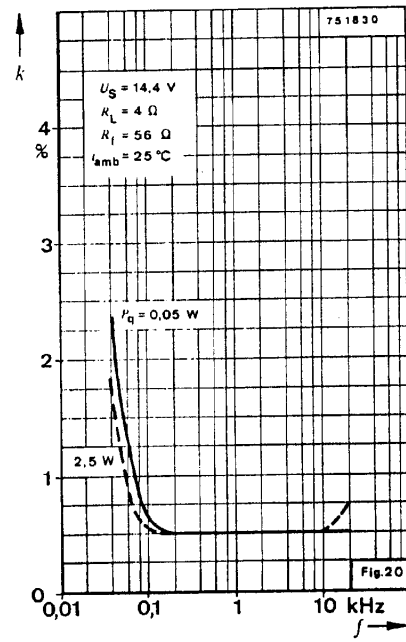
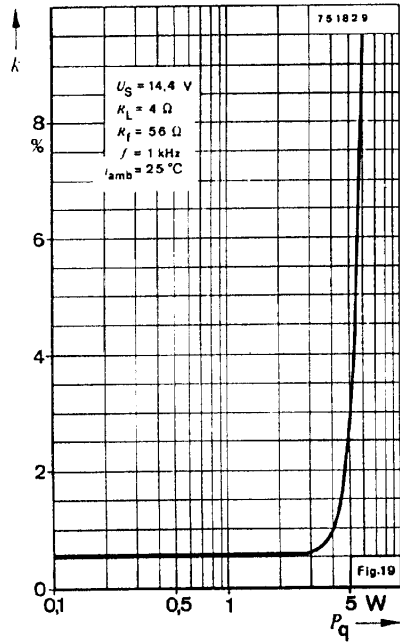
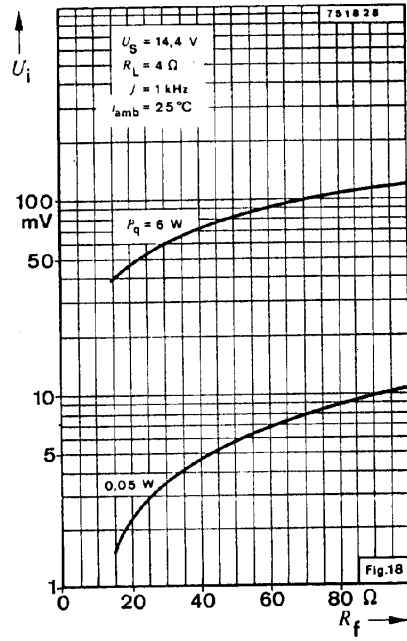
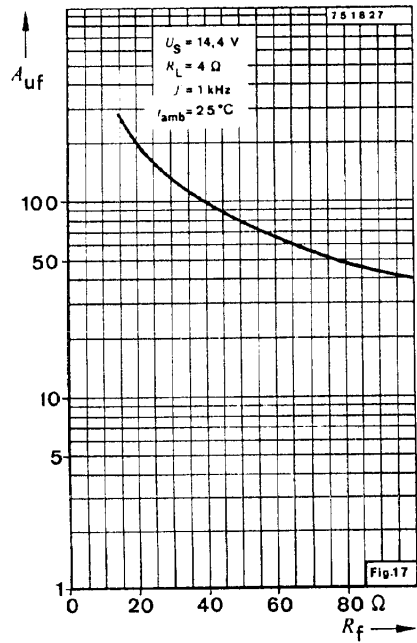

Fig. 21 Schaltungsbeispiel mit hochliegendem  $R_L$   
Circuit example with load connected to supply voltage