

TC4029BP/BF

C²MOS DIGITAL INTEGRATED CIRCUIT
SILICON MONOLITHIC

TC4029BP/TC4029BF PRESETTABLE UP/DOWN COUNTER

TC4029BP/BF is up/down counter having the capabilities of preset operation, parallel carry connection and decimal/binary switching. Switching of decimal counter and binary counter is controlled by BINARY/DECADE input ("H"-Binary and "L"-Decimal), and switching of UP/DOWN is controlled by UP/DOWN input ("H"-Count up and "L"-Count down). As PRESET ENABLE input at "H" level causes input information at A_{IN} through D_{IN} to be directly input to the flip-flops, any arbitrary count can be set. The counter advances its counting state by rising edge of CLOCK input.

MAXIMUM RATINGS

CHARACTERISTIC	SYMBOL	RATING	UNIT
DC Supply Voltage	V _{DD}	V _{SS} -0.5 ~ V _{SS} +20	V
Input Voltage	V _{IN}	V _{SS} -0.5 ~ V _{DD} +0.5	V
Output Voltage	V _{OUT}	V _{SS} -0.5 ~ V _{DD} +0.5	V
DC Input Current	I _{IN}	±10	mA
Power Dissipation	PD	300(DIP)/180(MFP)	mW
Operating Temperature Range	T _A	-40 ~ 85	°C
Storage Temperature Range	T _{stg}	-65 ~ 150	°C
Lead Temp./Time	T _{sol}	260°C • 10sec	

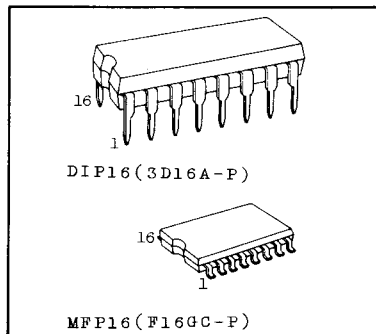

PIN ASSIGNMENT

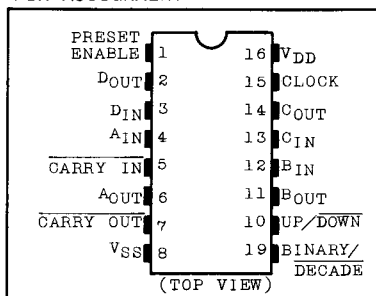

LOGIC DIAGRAM

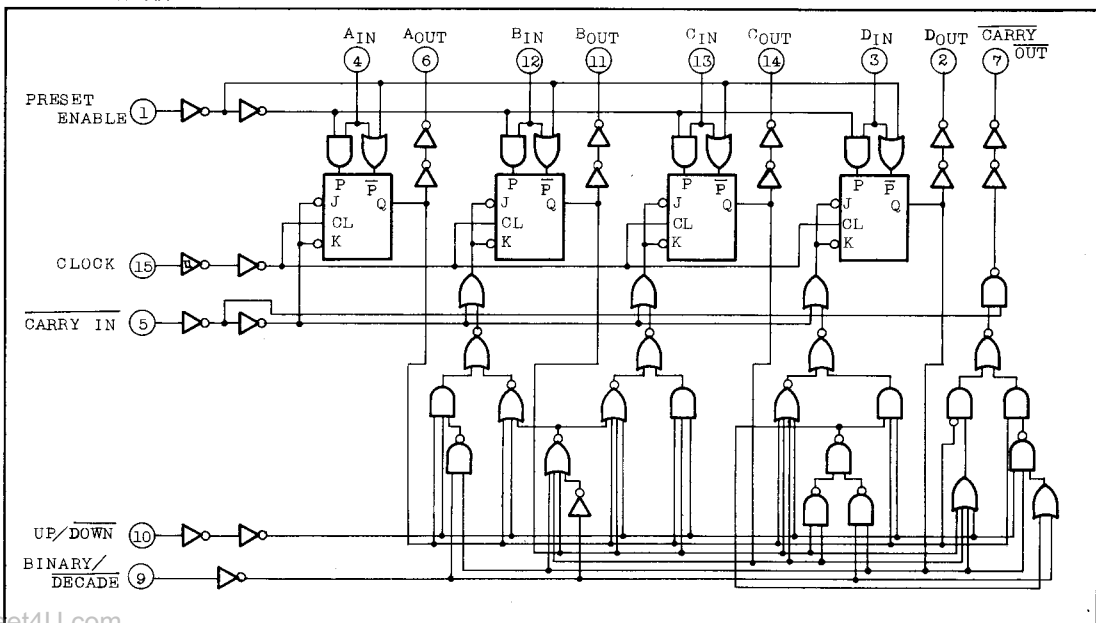

TRUTH TABLE

CARRY IN	PRESET ENABLE	UP/DOWN	BINARY/DECADE	OPERATION	* Don't care
L	L	H	*	UP COUNT	
L	L	L	*	DOWN COUNT	
*	H	*	*	PRESET	
H	L	*	*	NO COUNT	
L	L	*	H	BINARY COUNT	
L	L	*	L	DECADE COUNT	

TIMING DIAGRAM

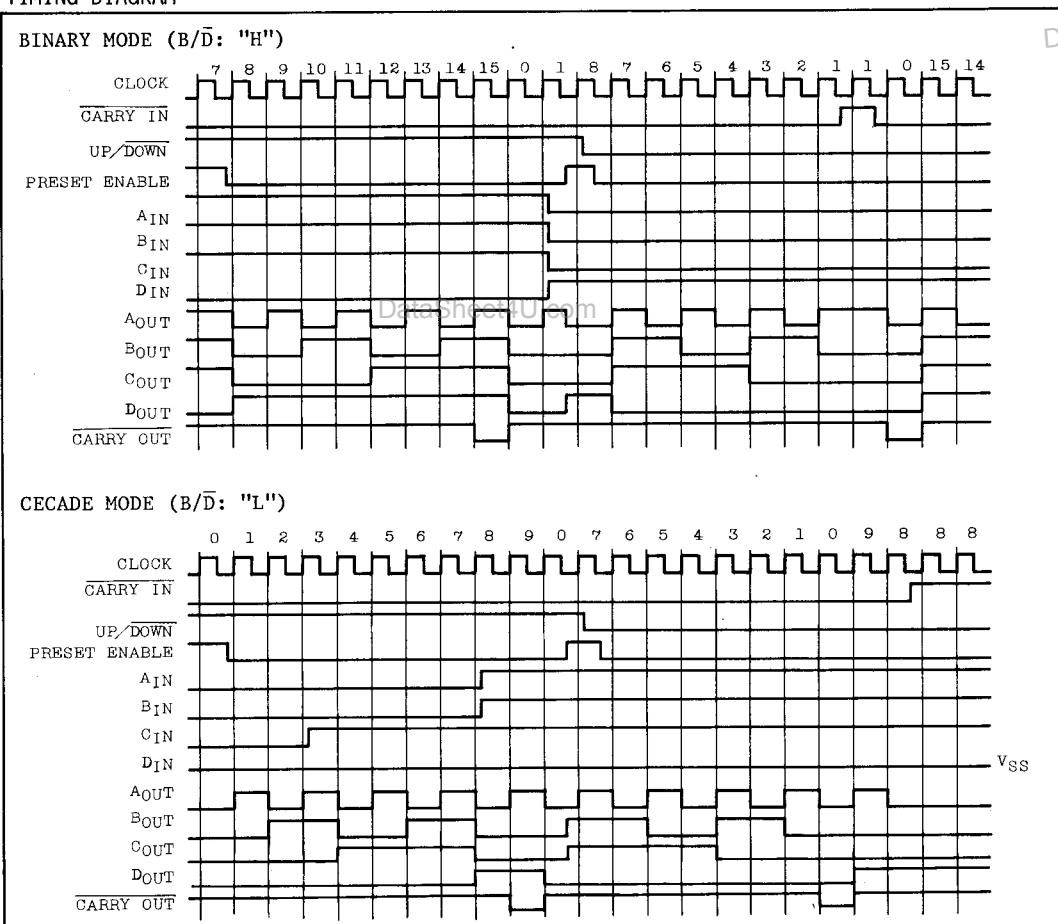

TC4029BP/BF

RECOMMENDED OPERATING CONDITIONS (V_{SS}=0V)

CHARACTERISTIC	SYMBOL	MIN.	TYP.	MAX.	UNIT
DC Supply Voltage	V _{DD}	3	-	18	V
Input Voltage	V _{IN}	0	-	V _{DD}	V

STATIC ELECTRICAL CHARACTERISTICS (V_{SS}=0V)

CHARACTERISTIC	SYMBOL	TEST CONDITION	V _{DD} (V)	-40°C		25°C			85°C		UNIT	
				MIN.	MAX.	MIN.	TYP.	MAX.	MIN.	MAX.		
High-Level Output Voltage	V _{OH}	I _{OUT} < 1μA V _{IN} =V _{SS} , V _{DD}	5	4.95	-	4.95	5.00	-	4.95	-	V	
			10	9.95	-	9.95	10.00	-	9.95	-		
			15	14.95	-	14.95	15.00	-	14.95	-		
Low-Level Output Voltage	V _{OL}	I _{OUT} < 1μA V _{IN} =V _{SS} , V _{DD}	5	-	0.05	-	0.00	0.05	-	0.05	V	
			10	-	0.05	-	0.00	0.05	-	0.05		
			15	-	0.05	-	0.00	0.05	-	0.05		
Output High Current	I _{OH}	V _{OH} =4.6V	5	-0.61	-	-0.51	-1.0	-	-0.42	-	mA	
		V _{OH} =2.5V	5	-2.5	-	-2.1	-4.0	-	-1.7	-		
		V _{OH} =9.5V	10	-1.5	-	-1.3	-2.2	-	-1.1	-		
		V _{OH} =13.5V	15	-4.0	-	-3.4	-9.0	-	-2.8	-		
Output Low Current	I _{OL}	V _{OL} =0.4V	5	0.61	-	0.51	1.2	-	0.42	-	mA	
		V _{OL} =0.5V	10	1.5	-	1.3	3.2	-	1.1	-		
		V _{OL} =1.5V	15	4.0	-	3.4	12.0	-	2.8	-		
		V _{IN} =V _{SS} , V _{DD}										
Input High Voltage	V _{IH}	V _{OUT} =0.5V, 4.5V	5	3.5	-	3.5	2.75	-	3.5	-	V	
		V _{OUT} =1.0V, 9.0V	10	7.0	-	7.0	5.5	-	7.0	-		
		V _{OUT} =1.5V, 13.5V	15	11.0	-	11.0	8.25	-	11.0	-		
Input Low Voltage	V _{IL}	I _{OUT} < 1μA										
		V _{OUT} =0.5V, 4.5V	5	-	1.5	-	2.25	1.5	-	1.5		
		V _{OUT} =1.0V, 9.0V	10	-	3.0	-	4.5	3.0	-	3.0		
		V _{OUT} =1.5V, 13.5V	15	-	4.0	-	6.75	4.0	-	4.0		
Input Current	"H" Level	I _{IH}	V _{IH} =18V	18	-	0.1	-	10 ⁻⁵	0.1	-	1.0	μA
	"L" Level	I _{IL}	V _{IL} =0V	18	-	-0.1	-	-10 ⁻⁵	-0.1	-	-1.0	

STATIC ELECTRICAL CHARACTERISTICS (V_{SS}=0V)

CHARACTERISTIC	SYMBOL	TEST CONDITION	V _{DD} (V)	-40°C		25°C			85°C		UNIT
				MIN.	MAX.	MIN.	TYP.	MAX.	MIN.	MAX.	
Quiescent Device Current	I _{DD}	V _{ID} =V _{SS} , V _{DD} *	5	-	5	-	0.005	5	-	150	μA
			10	-	10	-	0.010	10	-	300	
			15	-	20	-	0.015	20	-	600	

* All valid input combinations.

DYNAMIC ELECTRICAL CHARACTERISTICS (T_a=25°C, V_{SS}=0V, C_L=50pF)

CHARACTERISTIC	SYMBOL	TEST CONDITION	V _{DD} (V)	MIN.	TYP.	MAX.	UNIT
			10	-	35	100	
			15	-	30	80	
Output Transition Time (High to Low)	t _{THL}		5	-	70	200	
			10	-	35	100	
			15	-	30	80	
Propagation Delay Time (CLOCK - A, B, C, D _{OUT})	t _{pLH} t _{pHL}		5	-	180	470	
			10	-	85	200	
			15	-	65	160	
Propagation Delay Time (CLOCK - $\overline{\text{CARRY OUT}}$)	t _{pLH} t _{pHL}		5	-	220	500	
			10	-	100	260	
			15	-	75	190	
Propagation Delay Time (PRESET ENABLE - A, B, C, D _{OUT})	t _{pLH} t _{pHL}		5	-	180	470	
			10	-	85	200	
			15	-	65	160	
Propagation Delay Time (PRESET ENABLE - $\overline{\text{CARRY OUT}}$)	t _{pLH} t _{pHL}		5	-	240	640	
			10	-	110	290	
			15	-	80	210	
Propagation Delay Time ($\overline{\text{CARRY IN}}$ - $\overline{\text{CARRY OUT}}$)	t _{pLH} t _{pHL}		5	-	85	340	
			10	-	45	100	
			15	-	35	80	
Min. Clock Pulse Width	t _w		5	-	40	130	
			10	-	20	70	
			15	-	15	50	

TC4029BP/BFDYNAMIC ELECTRICAL CHARACTERISTICS (Ta=25°C, V_{SS}=0V, C_L=50pF)

CHARACTERISTIC	SYMBOL	TEST CONDITION	V _{DD} (V)			UNIT	
			MIN.	TYP.	MAX.		
Min. Pulse Width (PRESET ENABLE)	t _{WH}		5	-	55	130	ns
			10	-	25	70	
			15	-	20	50	
Max. Clock Frequency	f _{CL}		5	2	5	-	MHz
			10	4	10	-	
			15	5.5	14	-	
Max. Clock Input Rise Time	t _{rCL}		5	No Limit			μs
Max. Clock Input Fall Time	t _{fCL}		10				
			15				
Min. Set-up Time (CARRY IN - CLOCK)	t _{SU}		5	-	75	140	ns
			10	-	35	60	
			15	-	25	30	
Min. Set-up Time (B/D, U/D - CLOCK)	t _{SU}		5	-	120	320	
			10	-	55	130	
			15	-	40	90	
Min. Set-up Time (A,B,C,D - PRESET ENABLE)	t _{SU}		5	-	35	70	
			10	-	15	30	
			15	-	10	20	
Min. Hold Time (CARRY IN - CLOCK)	t _H		5	-	-	50	
			10	-	-	30	
			15	-	-	25	
Min. Hold Time (B/D, U/D - CLOCK)	t _H		5	-	-	30	
			10	-	-	30	
			15	-	-	30	
Min. Hold Time (A,B,C,D - PRESET ENABLE)	t _H		5	-	15	70	
			10	-	10	40	
			15	-	5	40	
Min. Removal Time (PRESET ENABLE - CLOCK)	t _{rem}		5	-	40	150	
			10	-	20	80	
			15	-	15	60	
Input Capacitance	C _{IN}			-	5	7.5	pF

SWITCHING TIME TEST WAVEFORMS

WAVEFORM 1

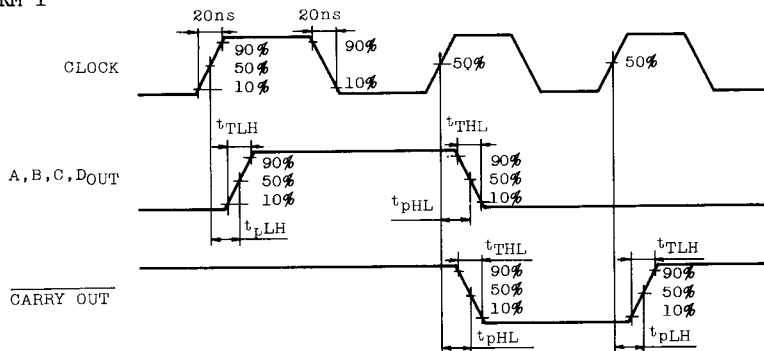

WAVEFORM 2

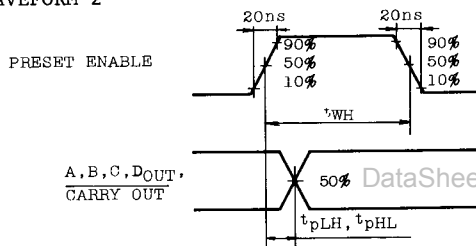

WAVEFORM 3

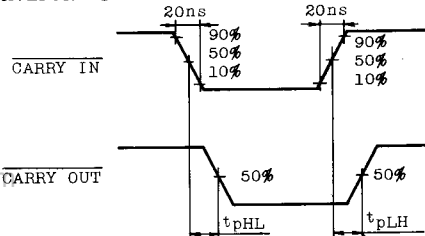

WAVEFORM 4

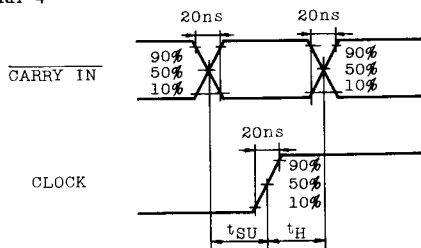

WAVEFORM 5

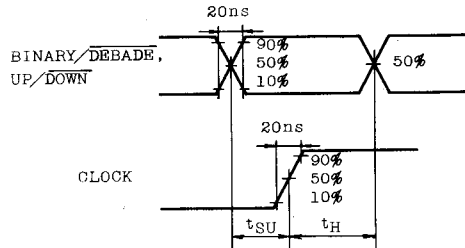

WAVEFORM 6

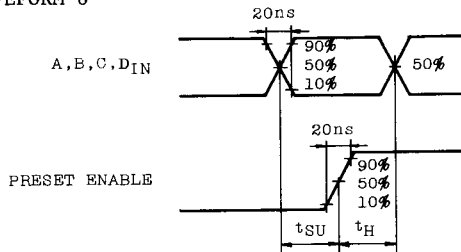

WAVEFORM 7

