



# SMD Coils

## RFID Transponder Coils - TC4308I Series

### RFID Transponder Coil Features

- High Q value.
- Low profile with an extended length.

### RFID Transponder Coil Applications

- Car remote control key.

### RFID Transponder Coil Configurations & Dimensions (unit: mm)

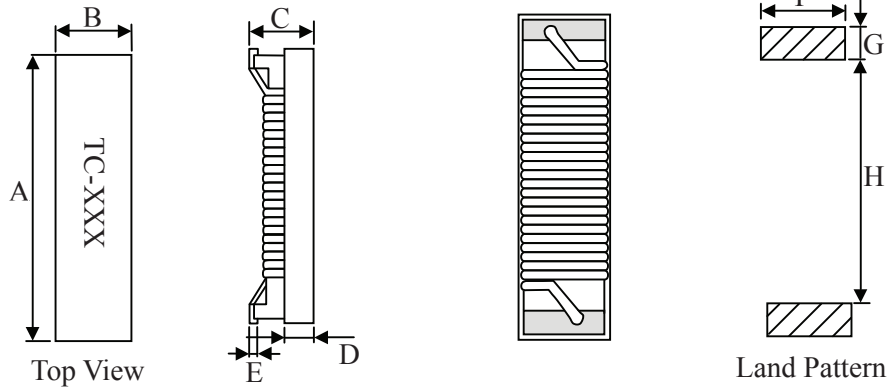

Type	A	B	C	D	E	F	G	H
TC4308I	11.43	3.15	2.74	1.01	0.51	2.79	1.78	8.46

Note: Design as Customer's Requested Specifications.

### RFID Transponder Coil Electrical Characteristics for TC4380I Series

Part Number	Inductance (mH)	Q (min)	Test Freq. (KHz)	SRF (KHz)(min)	DCR (Ω)(max)
TC4308I - 401J	0.40	15	125	4500	7.4
TC4308I - 901J	0.90	15	125	4000	22
TC4308I - 112J	1.08	15	125	4000	25
TC4308I - 202J	1.97	17	125	2400	34
TC4308I - 242J	2.38	17	125	2200	39
TC4308I - 332J	3.30	17	125	1800	51
TC4308I - 412J	4.15	17	125	1700	74
TC4308I - 492J	4.90	17	125	1300	96
TC4308I - 682J	6.80	17	125	1000	112
TC4308I - 712J	7.10	17	125	1000	115
TC4308I - 812J	8.10	17	125	960	123

Note: Test Freq.: 125KHz / 0.25V. Operating Temp.: -40°C+85°C.

### How to Order

-

①
②
③

① Coils RFID Transponder

② Inductance

③ Tolerance

Code	Tolerance
J	5%
K	10%
M	20%



# Tape and Reel Specifications

## Tape and Reel Specifications for Surface Mount

► Tape and Reel Specifications for Surface Mount (Unit: mm)

1. Reel Dimensions

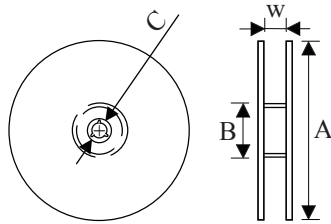

2. Tape Dimensions

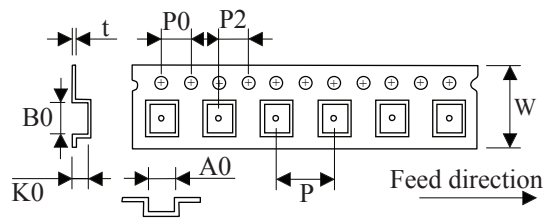

TOKEN Part No.	Piece / Reel		Reel Dimensions				Tape Dimensions							
	178	330	A	B	C	W	A0	B0	K0	P	P0	P2	W	t
<b>Multilayer Chip Inductors</b>														
TCMF100505	10,000	-	178	62	13	8.5	0.65	1.15	0.80	2	4	2	8	0.23
TCMF/I160808	4,000	-	178	62	13	8.5	1.01	1.80	1.05	4	4	2	8	0.23
TCMF/I201209	4,000	-	178	62	13	8.5	1.42	2.24	1.04	4	4	2	8	0.23
TCMI201212	2,000	-	178	62	13	8.5	1.50	2.30	1.60	4	4	2	8	0.23
TCMI321611	3,000	-	178	62	13	8.5	1.88	3.50	1.27	4	4	2	8	0.23
<b>Multilayer Chip Beads for Large Current</b>														
TCMB100505	10,000	-	178	62	13	8.5	0.65	1.15	0.80	2	4	2	8	0.23
TCMA/B160808	4,000	-	178	62	13	8.5	1.01	1.80	1.05	4	4	2	8	0.23
TCMA/B201209	4,000	-	178	62	13	8.5	1.42	2.24	1.04	4	4	2	8	0.23
TCMA/B321611	3,000	-	178	62	13	8.5	1.88	3.50	1.27	4	4	2	8	0.23
TCMB321616	2,000	-	178	62	13	8.5	1.88	3.61	1.78	4	4	2	8	0.23
TCMA/B322513	2,000	-	178	62	13	8.5	2.69	3.48	1.43	4	4	2	8	0.23
TCMA/B451616	2,000	-	178	62	13	12.5	1.93	4.95	1.93	4	4	2	12	0.23
TCMA/B453215	1,000	-	178	62	13	12.5	3.66	4.95	1.83	8	4	2	12	0.23
<b>RFID Transponder Coils</b>														
TC4308I	-	3,000	330	100	13	24.5	3.30	11.55	2.70	8	4	2	24	0.35
<b>Common Mode Choke Coils</b>														
TCB4F	-	2,000	330	100	13	12.5	4.40	5.40	3.50	8	4	2	12	0.4
TCB4FL	-	2,000	330	100	13	12.5	4.40	5.40	3.20	8	4	2	12	0.4
TCB5F	-	1,000	330	100	13	16.5	6.40	6.90	4.60	12	4	2	16	0.4
TCB5FL	-	1,500	330	100	13	16.5	6.40	6.90	3.95	12	4	2	16	0.4
<b>Air Core Inductors (Flat Top Air Core Inductors)</b>														
TCAM0603	-	4,000	330	100	13	12.5	1.55	2.00	2.00	8	4	2	12	0.3
TCAM0805	-	4,000	330	100	13	12.5	1.55	2.50	2.00	8	4	2	12	0.3
TCAM1008	-	4,000	330	100	13	12.5	1.55	3.20	2.00	8	4	2	12	0.3
TCAM2215	-	4,000	330	100	13	12.5	1.60	2.40	1.50	8	4	2	12	0.3
TCAM4015	-	4,000	330	100	13	12.5	1.60	4.20	1.50	8	4	2	12	0.3
TCAM3730	-	2,500	330	100	13	12.5	3.50	4.00	3.20	8	4	2	12	0.3
TCAM7030	-	2,000	330	100	13	16.5	3.50	7.00	3.20	8	4	2	16	0.3
TCAM1812	-	2,000	330	100	13	16.5	5.45	6.80	4.00	8	4	2	16	0.3
TCAM132	-	1,000	330	100	13	16.5	4.70	9.10	4.90	8	4	2	16	0.3



# Tape and Reel Specifications

1. Reel Dimensions

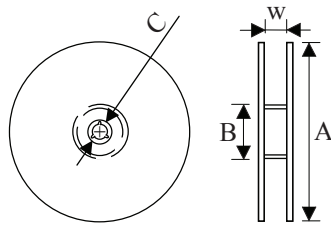

2. Tape Dimensions

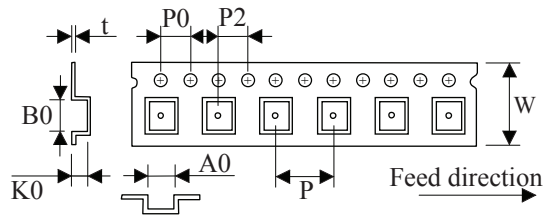

TOKEN Part No.	Piece / Reel		Reel Dimensions				Tape Dimensions							
	178	330	A	B	C	W	A0	B0	K0	P	P0	P2	W	t
<b>Shielded Power Inductors - TCD series</b>														
TCD62LCB	-	2,000	330	100	13	12.5	6.20	6.20	2.10	8	4	2	12	0.3
TCD62CB	-	2,000	330	100	13	12.5	6.30	6.30	2.60	8	4	2	12	0.3
TCD63LCB	-	2,000	330	100	13	12.5	6.20	6.20	3.10	8	4	2	12	0.4
TCD63CB	-	1,500	330	100	13	12.5	6.35	6.35	3.55	12	4	2	12	0.4
TCD73C	-	1,000	330	100	13	16.5	7.60	7.60	4.00	12	4	2	16	0.3
TCD75C	-	1,000	330	100	13	16.5	7.60	7.60	5.40	12	4	2	16	0.4
TCD1014C	-	2,000	330	100	13	24.5	10.50	10.50	2.00	16	4	2	24	0.4
TCD4009C	-	5,000	330	100	13	12.5	5.15	5.15	1.5	8	4	2	12	0.4
TCD4011C	-	5,000	330	100	13	12.5	5.15	5.15	1.5	8	4	2	12	0.4
TCD4014C	-	5,000	330	100	13	12.5	5.15	5.15	1.5	8	4	2	12	0.4
TCD7014C	-	2,500	330	100	13	16.5	7.40	7.40	2.00	12	4	2	16	0.4
TCD7026C	-	1,500	330	100	13	16.5	7.40	7.40	3.00	12	4	2	16	0.4
<b>Shielded Power Inductors - RB series</b>														
TCR63B	-	2,000	330	100	13	12.5	5.70	6.30	3.60	8	4	2	12	0.3
TCR74B	-	1,000	330	100	13	16.5	7.20	8.00	5.60	12	4	2	16	0.35
TCR105B	-	500	330	100	13	24.5	9.20	10.20	5.90	12	4	2	24	0.4
<b>Shielded Power Inductors - RH series</b>														
TCRH62B	-	1,500	330	100	13	16.5	6.55	7.00	3.20	12	4	2	16	0.4
TCRH64B	-	1,000	330	100	13	16.5	6.55	7.00	5.20	12	4	2	16	0.4
TCRH73	-	1,000	330	100	13	16.5	7.60	7.60	4.00	12	4	2	16	0.3
TCRH74	-	1,000	330	100	13	16.5	7.60	7.60	5.40	12	4	2	16	0.4
TCRH124	-	500	330	100	13	24.5	12.55	12.55	5.05	16	4	2	24	0.35
TCRH125	-	500	330	100	13	24.5	12.55	12.55	6.40	16	4	2	24	0.35
TCRH127	-	500	330	100	13	24.5	12.55	12.55	8.10	16	4	2	24	0.35
TCRH124B	-	500	330	100	13	24.5	12.55	12.55	5.05	16	4	2	24	0.35
TCRH125B	-	500	330	100	13	24.5	12.55	12.55	6.40	16	4	2	24	0.35
TCRH127B	-	500	330	100	13	24.5	12.55	12.55	8.10	16	4	2	24	0.35
TCRH103R	-	1,000	330	100	13	24.5	10.30	10.50	3.10	16	4	2	24	0.35
TCRH104R	-	1,000	330	100	13	24.5	10.30	10.50	4.10	16	4	2	24	0.35
TCRH105R	-	500	330	100	13	24.5	10.30	10.50	5.10	16	4	2	24	0.35
TCRH8D43	-	500	330	100	13	16.5	9.90	8.30	4.50	16	4	2	16	0.4



# Tape and Reel Specifications

1. Reel Dimensions

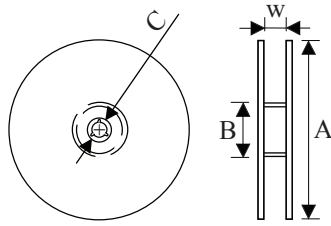

2. Tape Dimensions

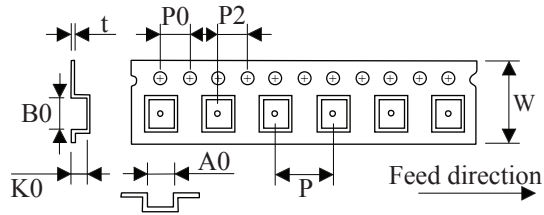

TOKEN Part No.	Piece / Reel		Reel Dimensions				Tape Dimensions							
	178	330	A	B	C	W	A0	B0	K0	P	P0	P2	W	t
<b>Shielded Power Inductors - RH series</b>														
TCRH2D18A	-	3,000	330	100	13	12.5	3.40	3.40	2.10	8	4	2	12	0.35
TCRH3D16A	-	3,000	330	100	13	12.5	4.10	4.10	2.10	8	4	2	12	0.35
TCRH4D18	-	2,000	330	100	13	12.5	5.10	5.10	2.10	8	4	2	12	0.3
TCRH4D28	-	2,000	330	100	13	12.5	5.10	5.10	3.10	8	4	2	12	0.3
TCRH5D18	-	2,000	330	100	13	12.5	6.10	6.10	2.10	8	4	2	12	0.3
TCRH5D28	-	2,000	330	100	13	12.5	6.10	6.10	3.10	8	4	2	12	0.3
TCRH6D28	-	1,000	330	100	13	16.5	7.60	7.60	3.10	12	4	2	16	0.35
TCRH6D38	-	1,000	330	100	13	16.5	7.60	7.60	4.10	12	4	2	16	0.35
TCRH8D28	-	1,000	330	100	13	16.5	9.90	8.30	3.00	16	4	2	16	0.4
TCRH8D43	-	500	330	100	13	16.5	9.90	8.30	4.50	16	4	2	16	0.4
<b>Shielded Power Inductors - DS series</b>														
TCDS104C2	-	500	330	100	13	24.5	10.30	10.50	5.10	16	4	2	24	0.35
TCDS106C2	-	500	330	100	13	24.5	10.60	10.70	7.00	16	4	2	24	0.5
TCDS126C2	-	500	330	100	13	24.5	12.55	12.55	8.10	16	4	2	24	0.35
<b>Shielded Power Inductors - SLF series</b>														
TCSLF6028	-	1,500	330	100	13	12.5	6.35	6.35	3.55	12	4	2	12	0.4
TCSLF10145	-	500	330	100	13	24.5	10.30	10.50	5.10	16	4	2	24	0.4
TCSLF12555	-	500	330	100	13	24.5	13.05	13.05	6.20	16	4	2	24	0.4
TCSLF12565	-	500	330	100	13	24.5	13.05	13.05	7.20	16	4	2	24	0.4
TCSLF12575	-	500	330	100	13	24.5	13.05	13.05	8.20	16	4	2	24	0.4
<b>Shielded Power Inductors - DC series</b>														
TC1608DC	-	2,500	330	100	13	16.5	4.25	6.50	3.00	8	4	2	16	0.35
TC3316DC	-	1,000	330	100	13	24.5	9.55	13.10	5.40	12	4	2	24	0.35
TC5022DC	-	250	330	100	13	32.5	15.40	18.80	7.50	20	4	2	32	0.4
<b>SMT Unshielded Power Inductors - UD Series</b>														
TCD4006	1,000	-	178	62	13	12.5	5.80	6.30	1.30	8	4	2	12	0.4
TCD4008	1,000	-	178	100	13	12.5	5.80	6.30	1.30	8	4	2	12	0.4
TCD4011	1,000	-	178	100	13	12.5	4.50	5.60	1.55	8	4	2	12	0.4
TCD4013	1,000	-	178	100	13	12.5	4.50	5.60	1.55	8	4	2	12	0.4
TCD5011	-	4,500	330	100	13	12.5	5.90	7.50	1.70	8	4	2	12	0.4
TCD5013	-	4,500	330	100	13	12.5	5.90	7.50	1.70	8	4	2	12	0.4



# Tape and Reel Specifications

1. Reel Dimensions

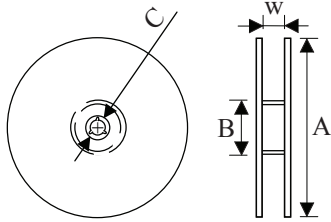

2. Tape Dimensions

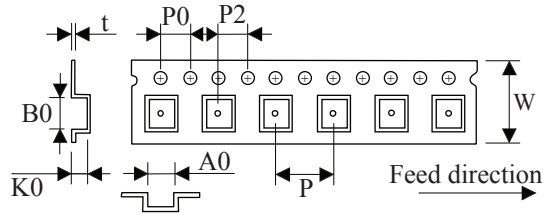

TOKEN Part No.	Piece / Reel		Reel Dimensions				Tape Dimensions							
	178	330	A	B	C	W	A0	B0	K0	P	P0	P2	W	t

## SMT Unshielded Power Inductors - UTC series

TC32	2,000	-	178	62	13	8.5	3.12	3.84	2.24	4	4	2	8	0.3
TC43	-	1,500	330	100	13	12.5	4.20	4.60	3.60	8	4	2	12	0.3
TC52	-	2,500	330	100	13	12.5	5.50	6.00	2.70	8	4	2	12	0.3
TC53	-	1,500	330	100	13	12.5	5.60	6.20	3.30	8	4	2	12	0.4
TC54	-	1,500	330	100	13	12.5	5.60	6.20	4.70	8	4	2	12	0.3
TC73	-	1,000	330	100	13	16.5	7.30	8.00	3.80	12	4	2	16	0.3
TC75	-	1,000	330	100	13	16.5	7.20	8.00	5.60	12	4	2	16	0.35
TC104	-	500	330	100	13	24.5	9.60	10.30	4.20	12	4	2	24	0.35
TC105	-	500	330	100	13	24.5	9.60	10.30	5.80	12	4	2	24	0.4

TCD73F	-	1,000	330	100	13	16.5	7.60	7.60	4.00	12	4	2	16	0.3
TCD75F	-	1,000	330	100	13	16.5	7.60	7.60	5.40	12	4	2	16	0.4
TC1608DF	-	2,500	330	100	13	16.5	4.25	6.50	3.00	8	4	2	16	0.35
TC3308DF	-	1,000	330	100	13	24.5	9.70	13.25	3.30	12	4	2	24	0.35
TC3316DF	-	1,000	330	100	13	24.5	9.55	13.10	5.40	12	4	2	24	0.35
TC3340DF	-	225	330	100	13	32.5	9.70	13.40	11.50	20	4	2	32	0.5
TC5022DF	-	250	330	100	13	32.5	15.40	18.80	7.50	20	4	2	32	0.4
TC1813DHP	-	1,000	330	100	13	16.5	6.30	9.15	4.90	12	4	2	16	0.4
TC3316DHP	-	1,000	330	100	13	24.5	9.55	13.10	5.40	12	4	2	24	0.35
TC5022DHP	-	250	330	100	13	32.5	16.00	21.90	7.65	20	4	2	32	0.5

## Backlight Power Inductors

TC1608DBL	-	2,500	330	100	13	16.5	4.25	6.50	3.00	8	4	2	16	0.35
-----------	---	-------	-----	-----	----	------	------	------	------	---	---	---	----	------

## Toroidal Power Inductors

TCTX-2P	-	500	330	100	13	24.5	10.25	10.25	5.50	16	4	2	24	0.4
TCTX-4P	-	500	330	100	13	24.5	12.70	12.70	7.00	16	4	2	24	0.4
TC302	-	500	330	100	13	24.5	8.95	10.25	6.90	16	4	2	24	0.4
TC502	-	250	330	100	13	32.5	13.80	16.50	10.20	24	4	2	32	0.4
TC302A	-	500	330	100	13	24.5	8.95	10.25	6.90	16	4	2	24	0.4
TC502A	-	250	330	100	13	32.5	13.80	16.50	10.20	24	4	2	32	0.4
TC0718	-	3,000	330	100	13	16.5	5.30	7.90	2.20	8	4	2	16	0.4