

TC5001P 4-DIGIT DECADE COUNTER

TC5001P is four digit decimal counter containing latches and multiplexer circuits and equipped with the terminals of digit signal outputs for dynamic display, blanking input (for zero suppress operation) and transfer input (latch operation). The maximum count of this counter is 9999 and three CARRY terminals are provided for carry operations required in some applications. Refer to TRUTH TABLE, TIMING CHART and OPERATING CONSIDERATION for the operations.

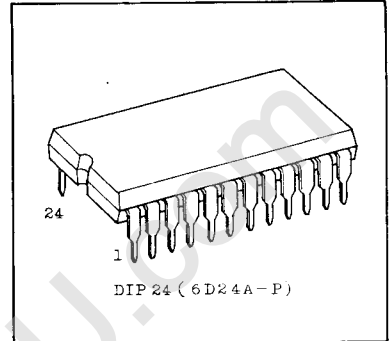

ABSOLUTE MAXIMUM RATINGS

CHARACTERISTIC	SYMBOL	RATING	UNIT
DC Supply Voltage	V _{DD}	V _{SS} -0.5 ~ V _{SS} +10	V
Input Voltage	V _{IN}	V _{SS} -0.5 ~ V _{DD} +0.5	V
Output Voltage	V _{OUT}	V _{SS} -0.5 ~ V _{DD} +0.5	V
DC Input Current	I _{IN}	±10	mA
Power Dissipation	PD	300	mW
Storage Temperature Range	T _{stg}	-55 ~ 125	°C
Lead Temp./Time	T _{sol}	260°C · 10sec	

PIN ASSIGNMENT

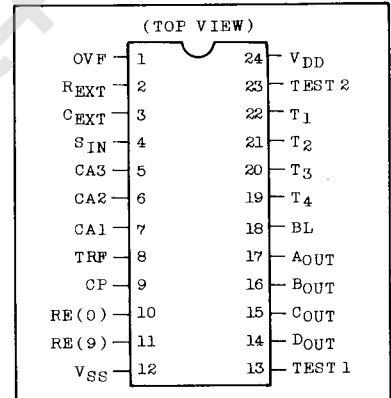

BLOCK DIAGRAM

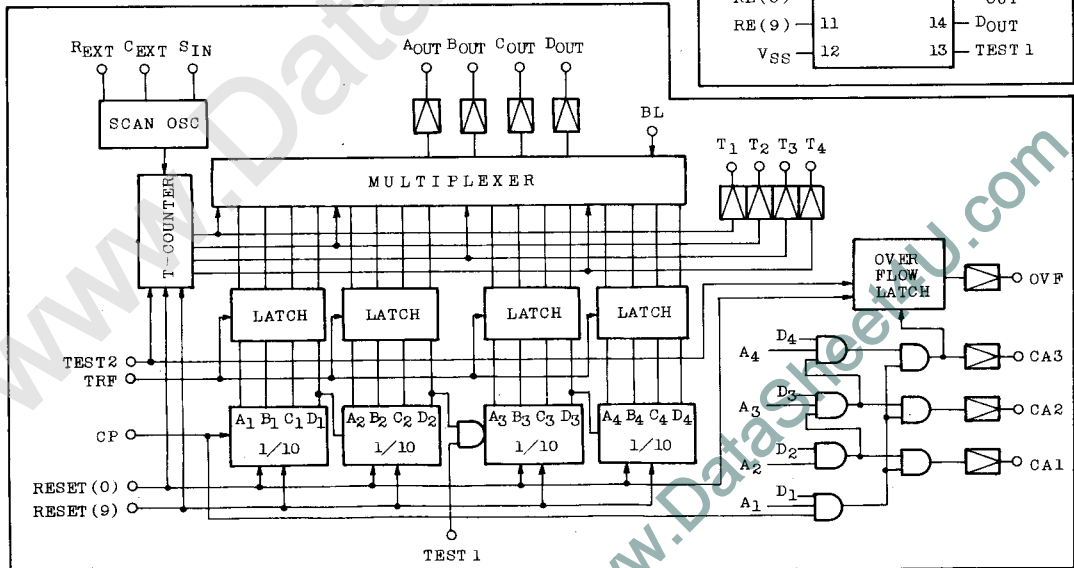

DESCRIPTION OF PIN FUNCTION

PIN No.	SYMBOL	NAME	FUNCTION	
1	OVF	OVER FLOW	Terminal to detect OVER FLOW condition of the counter which generates "H" level when COUNT is incremented from "9999". Once set to "H", only RESET (0) can clear it to "L".	
2	R _{EXT}	RESISTER EXTERNAL	This is opened when external CLOCK is supplied from S _{IN} . If external CLOCK is not available, CLOCK can be generated by externally connecting a resistor across S _{IN} and R _{EXT} and a capacitor across S _{IN} and C _{EXT} .	
3	C _{EXT}	CAPACITANCE EXTERNAL		
4	S _{IN}	SCAN INPUT	T-COUNTER CLOCK input and T-COUNTER is changed its condition at the falling edge of S _{IN} .	
5	CA3	CARRY-3	CARRY output from n-th digit	
6	CA2	CARRY-2		
7	CA1	CARRY-1		
8	TRF	TRANSFER	"H"	Decimal COUNTER output is transferred to MULTIPLEXER as it is.
			"L"	COUNTER output at the time of falling edge of TRF is latched.
9	CP	COUNT INPUT	Lowest order decimal COUNTER CLOCK input and COUNTER is counted by the falling edge of CP.	
10	RE (0)	RESET (0)	"H"	Decimal COUNTER output is reset to "0000". This takes precedence over RE (9).
			"L"	If RE (9) = "L", normally counted.
11	RE (9)	RESET (9)	"H"	If RE (0) = "L", COUNTER output is set to "9999".
			"L"	If RE (0) = "L", normally counted.
12	V _{SS}	V _{SS}	(GND)	

DESCRIPTION OF PIN FUNCTION

PIN No.	SYMBOL	NAME	FUNCTION	
13	TEST ₁	TEST ₁	"H"	If TEST (2) = "H", normally counted.
			"L"	If TEST (2) = "H", only lower order two digits are counted.
14	DOUT	D-OUTPUT	Decimal COUNTER BCD outputs. When T ₁ ="H", the lowest order digit (first digit) is output, when T ₂ = "H", the second digit is output, ... and when T ₄ = "H", the fourth digit is output. During BLANKING all the outputs become "H".	
15	COUT	C-OUTPUT		
16	BOUT	B-OUTPUT		
17	AOUT	A-OUTPUT		
18	BL	BLANKING	If BL = "H", only all AOUT through DOUT (BCD OUT) become "H".	
19	T ₄	T ₄	Output to indicate the digit position of output signals AOUT through DOUT (BCD OUT) and corresponds in descending order from T ₁ .	
20	T ₃	T ₃		
21	T ₂	T ₂		
22	T ₁	T ₁		
23	TEST ₂	TEST ₂	"H"	Normally counted.
			"L"	Causes T ₁ = "L", T ₂ ~T ₄ = "H", OVF = "H".
24	VDD	VDD	VDD Power Supply (3~8 volt)	

TC5001P

TIMING CHART

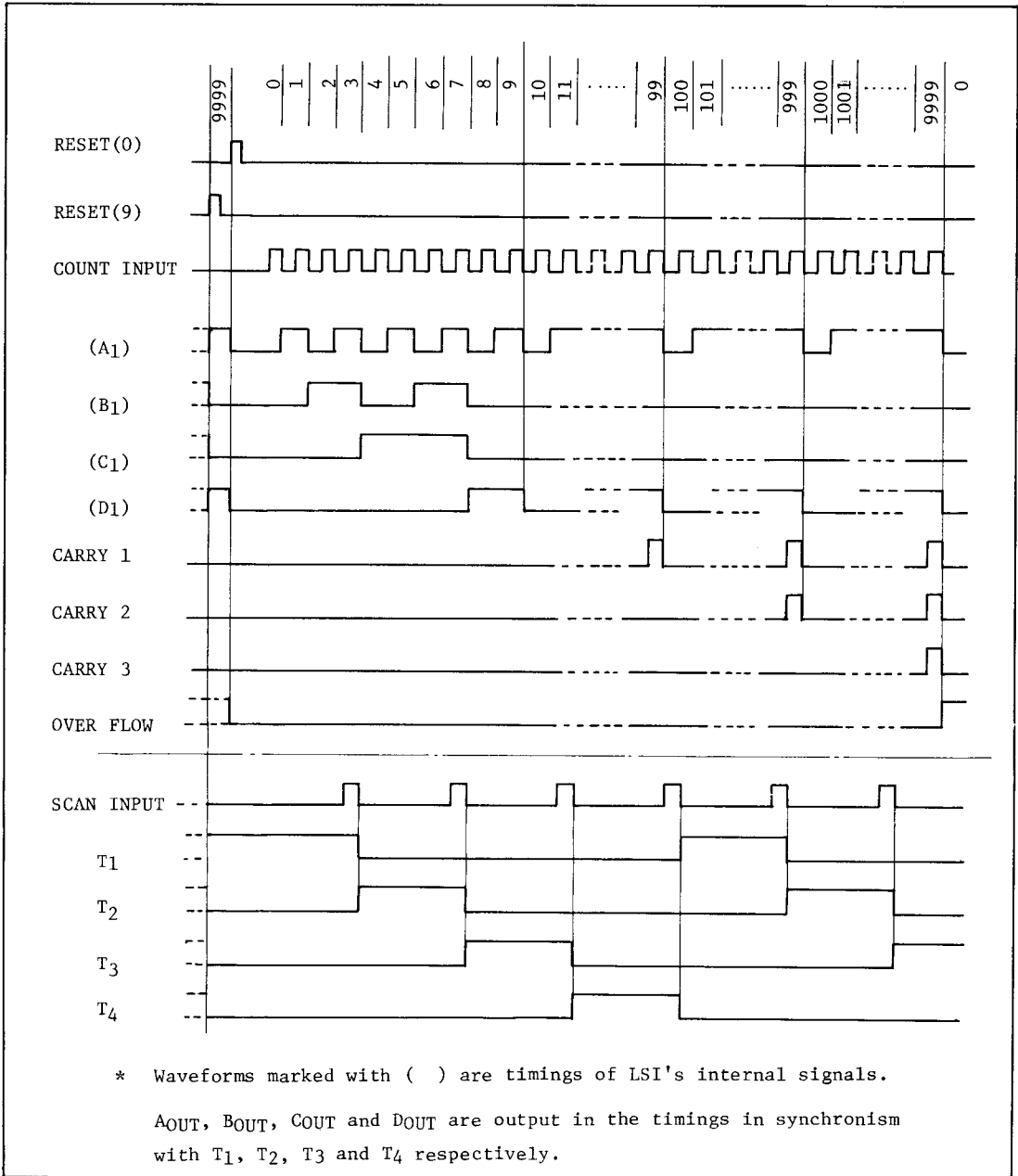



TRUTH TABLE

RESET (0)	RESET (9)	TRANSFER	BLANKING	TEST ₁	TEST ₂	AOUT	BOUT	COUT	DOUT	T ₁	T ₂	T ₃	T ₄	OVER FLOW	
H	*	H	L	*	H	L	L	L	L	H	L	L	L	L	Note-1
L	H	H	L	*	H	H	L	L	H	H	L	L	L	X	Note-1
L	L	H	L	H	H	C	C	C	C	S	S	S	S	X	
L	L	H	L	L	H	C'	C'	C'	C'	S	S	S	S	X	
*	*	L	L	*	*	LA	LA	LA	LA	X	X	X	X	X	
*	*	*	H	*	*	H	H	H	H	X	X	X	X	X	
*	*	*	*	*	L	X	X	X	X	L	H	H	H	H	

- * Don't Care
- X Not defined
- C Count operation (all digits)
- C' Count operation (only lower order two digits)
- LA Latch operation
- S Scan operation

Note 1. SCAN INPUT = "L"

o All the inputs/outputs (except COUNT INPUT and SCAN INPUT) are activated by "H" level.

o COUNT INPUT  SCAN INPUT 

o When used, TEST₁ = "H" and TEST₂ = "H" should be satisfied.

OPERATING CONSIDERATION

1. RESET Operation

- (1) When the level of RESET (0) terminal is set to "H", BCD output of COUNTER is set to "0". The four digit display becomes 0000.
- (2) When the level of RESET (9) terminal is set to "H", BCD output of COUNTER is set to "9". The four digit display becomes 9999.
- (3) When both of RESET (0) terminal and RESET (9) terminal are "H", RESET (0) terminal takes precedence.

2. SCAN Operation

- (1) SCAN signal for dynamic display applied to SCAN INPUT terminal controls the multiplexer circuit and transfers four digit information in the latches to BCD outputs one digit at a time in sequence.

OPERATING CONSIDERATION

- (2) Arbitrary digit can be made real time output (completely static) by making SCAN signal DC.
- (3) The digit pulses in synchronism with SCAN signal for dynamic display appear at the digit output terminals (T₁, T₂, T₃ and T₄). The digit output terminals (T₁, T₂, T₃ and T₄) are used for the digit selection circuit and for arbitrary digit zero suppress.
- (4) The digit pulse is activated by the falling edge of SCAN INPUT signal.
- (5) SCAN signal is supplied from the internal oscillator as shown in Fig. 1 or from the external one as shown in Fig. 2.

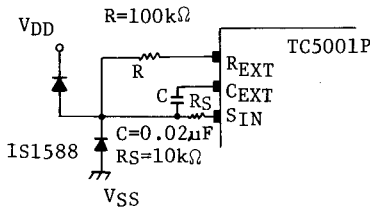

Fig. 1

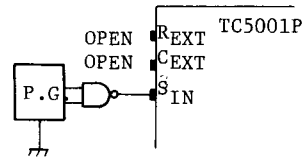

Fig. 2

$$f_{\text{SCAN}} = \frac{1}{2.2CR} \text{ [Hz]}$$

3. Latch Operation

- (1) When the level of TRANSFER terminal is "H", COUNTER information is transferred to the latches.
- (2) When the level of TRANSFER terminal is changed from "H" to "L", the information transferred from COUNTER is latched.

4. Count Operation

- (1) Set input terminals TEST₁, TEST₂ and TRANSFER to "H" and BLANKING terminal to "L".
- (2) COUNTER is set by applying "H" level to RESET (0) or RESET (9) terminal and two RESET terminals are returned to "L".

OPERATING CONSIDERATION

- (3) When the count pulse is applied to COUNT INPUT terminal, COUNTER performs its COUNT operation at the falling edge of count pulse.
- (4) The maximum count is 9999 and if 9999 is exceeded, "H" level appears at OVER FLOW terminal. Removal of OVER FLOW signal can be achieved by applying "H" to RESET (0) terminal.
- (5) The carry signals from 100's and 1000's digits appear at output terminals CARRY₁, CARRY₂ and CARRY₃.
- (6) When TEST₁ terminal is "L", only lower order two digits of COUNTER are counted.

5. BLANKING Operation

When BLANKING terminal is set to "H", all the BCD outputs of COUNTER become "H" and this signal is used to achieve the zero suppress operation.

TC5001P

RECOMMENDED OPERATING CONDITIONS (VSS=0V)

CHARACTERISTIC	SYMBOL	MIN.	TYP.	MAX.	UNIT
Supply Voltage	V _{DD}	3	-	8	V
Input Voltage	V _{IN}	0	-	V _{DD}	V
Operating Temp.	T _{opr}	-30	-	85	°C
External Registance	R _{EXT}	10	100	1000	kΩ
External Capacitance	C _{EXT}	10 ⁻⁴	0.02	1.0	μF

ELECTRICAL CHARACTERISTICS (VSS=0V)

CHARACTERISTIC	SYMBOL	TEST CONDITIONS	V _{DD} (V)	-30°C		25°C			85°C		UNIT
				MIN.	MAX.	MIN.	TYP.	MAX.	MIN.	MAX.	
High Level Output Voltage	V _{OH}	I _{OUT} < 1μA V _{IN} =V _{DD} ,V _{SS}	5	4.95	-	4.95	-	-	4.95	-	V
Low Level Output Voltage	V _{OL}	I _{OUT} < 1μA V _{IN} =V _{DD} ,V _{SS}	5	-	0.05	-	-	0.05	-	0.05	
High Level Output Current	A _{OUT} ,B _{OUT} C _{OUT} ,D _{OUT}	I _{OH}	5	-1.2	-	-1.0	-	-	-0.75	-	mA
	CARRY1,2,3 OVER FLOW T1,T2,T3, T4	I _{OH}	5	-1.2	-	-1.0	-	-	-0.75	-	
	R _{EXT} C _{EXT}	I _{OH}	5	-0.3	-	-0.25	-	-	-0.2	-	
Low Level Output Current	A _{OUT} ,B _{OUT} C _{OUT} ,D _{OUT}	I _{OL}	5	2.4	-	2.0	-	-	1.6	-	mA
	CARRY1,2,3 OVER FLOW T1,T2,T3, T4	I _{OL}	5	0.52	-	0.44	-	-	0.36	-	
	R _{EXT} C _{EXT}	I _{OL}	5	0.28	-	0.24	-	-	0.2	-	
Input Voltage	"H" Level	V _{IH}	5	3.8	-	3.8	2.75	-	3.8	-	V
	"L" Level	V _{IL}	5	-	1.2	-	2.25	1.2	-	1.2	
Input Current	"H" Level	I _{IH}	8	-	0.2	-	-	0.2	-	1.0	μA
	"L" Level	I _{IL}	8	-	-0.2	-	-	-0.2	-	-1.0	
Quiescent Current Consumption	I _{DD}	V _{IN} =V _{DD} ,V _{SS} *	8	-	50	-	-	50	-	500	μA

* All valid input combinations

SWITCHING CHARACTERISTICS (Ta=25°C, VSS=0V, CL = 50pF)

CHARACTERISTIC		SYMBOL	TEST CONDITIONS	VDD (V)	MIN.	TYP.	MAX.	UNIT
(LOW-HIGH) Propagation Delay Time		t _{pLH}	COUNT INPUT – A,B,C,DOUT (Waveform 1)	5	–	600	1000	ns
(HIGH-LOW) Propagation Delay Time		t _{pHL}		5	–	600	1000	
(LOW-HIGH) Propagation Delay Time		t _{pLH}	TRANSFER – A,B,C,DOUT (Waveform 2)	5	–	400	1000	
(HIGH-LOW) Propagation Delay Time		t _{pHL}		5	–	400	1000	
(LOW-HIGH) Propagation Delay Time		t _{pLH}	COUNT INPUT – CARRY _{1,2,3} – OVER FLOW (Waveform 3)	5	–	400	1000	
(HIGH-LOW) Propagation Delay Time		t _{pHL}		5	–	400	1000	
Max. Clock Rise Time		t _{rCL} , t _{fCL}		5	20	–	–	μs
Min. Clear Pulse Width		t _{w(RE)}	RESET(0), (9)	5	–	–	1000	ns
Min. Transfer Pulse Width		t _{w(TR)}	TRANSFER	5	–	–	1000	
Input Capacity	9, 10, 11, 18 PIN	C _{IN}			–	5	7.5	pF
	4, 13, 23 PIN	C _{IN}			–	7	10	
	8 PIN	C _{IN}			–	9	15	
Max. Clock Frequency		f _{CL}		5	0.5	2.0	–	MHz

SWITCHING TIME TEST CIRCUIT

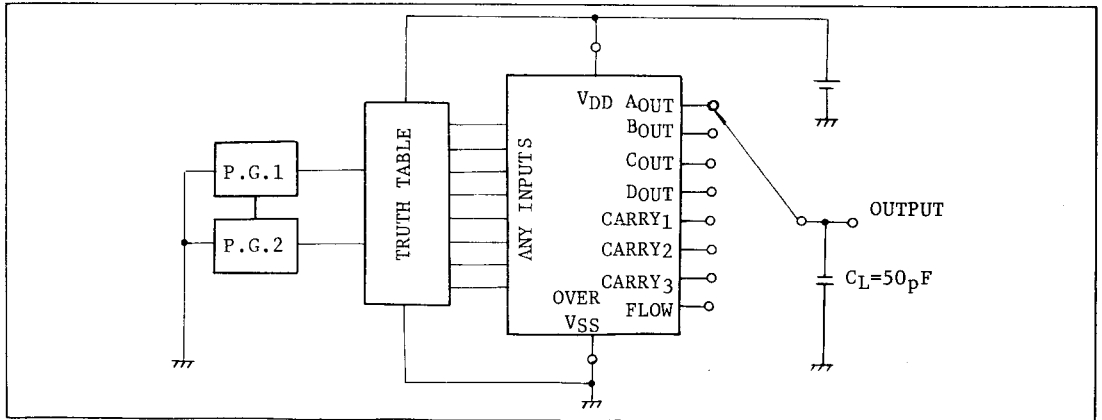

SWITCHING TIME TEST WAVEFORMS

