

TENTATIVE TOSHIBA MOS DIGITAL INTEGRATED CIRCUIT SILICON GATE CMOS

4 M (512 K × 8) BIT CMOS FLASH MEMORY

DESCRIPTION

The TC58FVT004/B004 is a 4,194,304 - bits, 3.0 Volt - only electrically erasable and programmable flash memory organized as 524,288 words × 8 bits. The TC58FVT004/B004 features commands for Read, Program and Erase operations to allow easy interfacing with microprocessors. The commands are based on the JEDEC standard. The Program and Erase operations are automatically executed in the chip. The device has Chip, Block and Multi - block erase capability.

The TC58FVT004/B004 is available in either a 40 - pin TSOP package to suit a variety of design applications.

FEATURES

- Power Supply
V_{DD} = 2.7 V to 3.6 V
- Organization
512 K × 8 bits
- Modes
Auto Program
Auto Chip Erase
Auto Block Erase
Auto Multiple Block Erase
Erase Suspend/Resume
Block Protection
Data Polling/Toggle Bit
- Block Erase Architecture
1 × 16 K byte / 2 × 8 K byte /
1 × 32 K byte / 7 × 64 K byte
- Boot Block Architecture
TC58FVT004FT ----- Top Boot Block
TC58FVB004FT ----- Bottom Boot Block
- Mode Control
Compatible with JEDEC - standard command
- Erase/Program Cycles
10⁵ Cycles Typ.
- Access Time
85 ns (V_{DD} = 3.0 V to 3.6 V)
100 ns / 120 ns (V_{DD} = 2.7 V to 3.0 V)
- Power Dissipation
250 μA (Standby TTL level)
10 μA (Standby CMOS level)
30 mA (Read Operating)
40 mA (Program/Eraser Operating)
- Package
TC58FVT004FT/B004FT : TSTOP I 40 - P - 1020 - 0.50
(Weight: 0.43 g typ.)

PIN ASSIGNMENT (TOP VIEW)

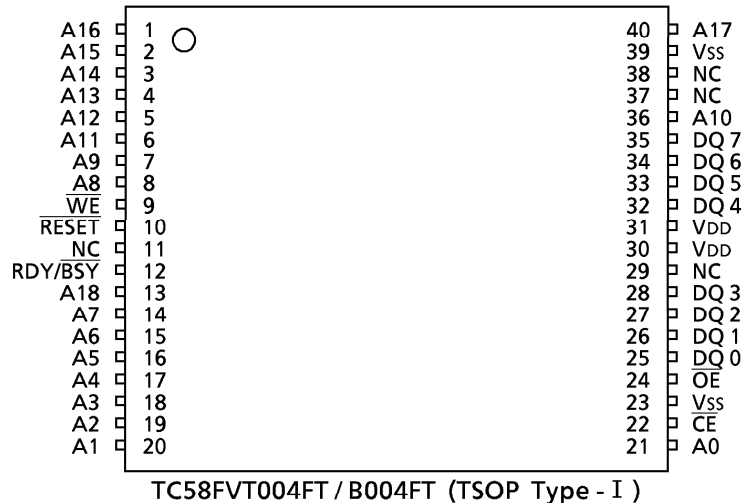

PIN NAMES

A0 to A18	Address Input
DQ0 to DQ7	Data Input / Output
CE	Chip Enable Input
OE	Output Enable Input
WE	Write Enable Input
RDY/BSY	Ready / Busy Output
RESET	Hardware Reset Input
NC	No Connection
V _{DD}	Power Supply
V _{SS}	Ground

961001EBA1

- TOSHIBA is continually working to improve the quality and the reliability of its products. Nevertheless, semiconductor devices in general can malfunction or fail due to their inherent electrical sensitivity and vulnerability to physical stress. It is the responsibility of the buyer, when utilizing TOSHIBA products, to observe standards of safety, and to avoid situations in which a malfunction or failure of a TOSHIBA product could cause loss of human life, bodily injury or damage to property. In developing your designs, please ensure that TOSHIBA products are used within specified operating ranges as set forth in the most recent products specifications. Also, please keep in mind the precautions and conditions set forth in the TOSHIBA Semiconductor Reliability Handbook.
- The products described in this document are subject to foreign exchange and foreign trade control laws.
- The information contained herein is presented only as a guide for the applications of our products. No responsibility is assumed by TOSHIBA CORPORATION for any infringements of intellectual property or other rights of the third parties which may result from its use. No license is granted by implication or otherwise under any intellectual property or other rights of TOSHIBA CORPORATION or others.
- The information contained herein is subject to change without notice.

BLOCK DIAGRAM

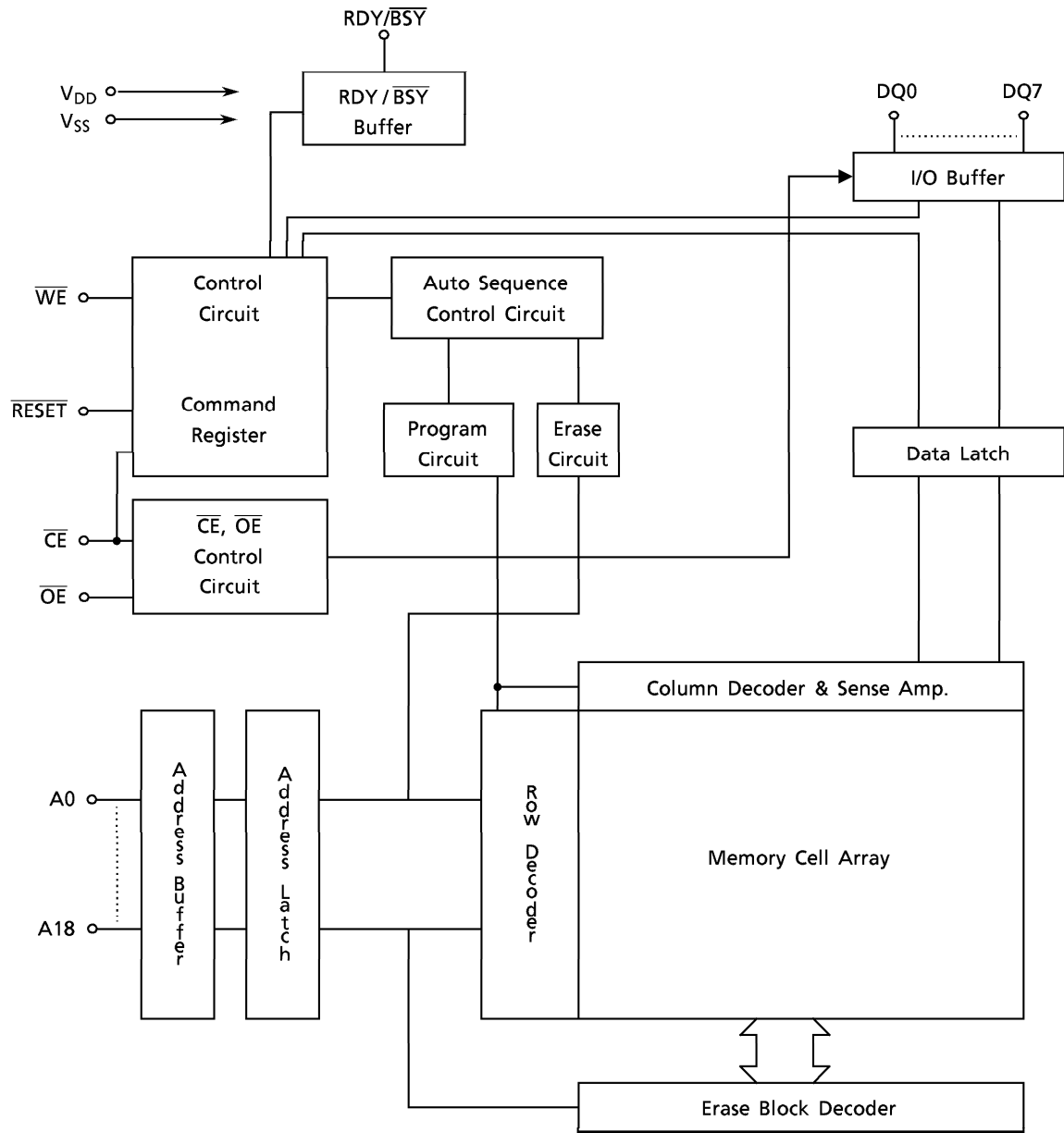

MODE SELECTION

MODE	\overline{CE}	\overline{OE}	\overline{WE}	A9	A6	A1	A0	\overline{RESET}	DQ0 to DQ7
Read	L	L	H	A9	A6	A1	A0	H	Dout
ID Read (Manufacturer Code)	L	L	H	V _{ID}	L	L	L	H	Code
ID Read (Device Code)	L	L	H	V _{ID}	L	L	H	H	Code
Standby	H	*	*	*	*	*	*	H	High - Z
Output Disable	*	H	H	*	*	*	*	*	High - Z
Write	L	H	L	A9	A6	A1	A0	H	Din
Block Protect	L	V _{ID}	L	V _{ID}	L	H	L	H	*
Verify Block Protect	L	L	H	V _{ID}	L	H	L	H	Code
Temporary Block Unprotect	*	*	*	*	*	*	*	V _{ID}	*
Hardware Reset/Standby	*	*	*	*	*	*	*	L	High - Z

Notes : * : V_{IH} or V_{IL}

ID CODE TABLE

TYPE		A18 to A13	A6	A1	A0	CODE (HEX)
Manufacturer Code		*	V _{IL}	V _{IL}	V _{IL}	98h
Device Code	TC58FVT004	*	V _{IL}	V _{IL}	V _{IH}	3Bh
	TC58FVB004	*	V _{IL}	V _{IL}	V _{IH}	BAh
Verify Block Protect		BA 1)	V _{IL}	V _{IH}	V _{IL}	Data 2)

Notes : * : V_{IH} or V_{IL}

1) BA : Block Address

2) 01h – Protected Block

00h – Unprotected Block

COMMAND SEQUENCE

COMMAND SEQUENCE	BUS WRITE CYCLES REQ'D	FIRST BUS WRITE CYCLE		SECOND BUS WRITE CYCLE		THIRD BUS WRITE CYCLE		FOURTH BUS READ/WRITE CYCLE		FIFTH BUS WRITE CYCLE		SIXTH BUS WRITE CYCLE	
		Addr.	Data	Addr.	Data	Addr.	Data	Addr.	Data	Addr.	Data	Addr.	Data
Read / Reset	1	XXXXh	F0h										
Read / Reset	3	5555h	AAh	2AAAh	55h	5555h	F0h	RA ¹⁾	RD ²⁾				
ID Read / Verify Block Protect	3	5555h	AAh	2AAAh	55h	5555h	90h	IA ³⁾	ID ⁴⁾				
Auto Program	4	5555h	AAh	2AAAh	55h	5555h	A0h	PA ⁵⁾	PD ⁶⁾				
Auto Chip Erase	6	5555h	AAh	2AAAh	55h	5555h	80h	5555h	AAh	2AAAh	55h	5555h	10h
Auto Block Erase	6	5555h	AAh	2AAAh	55h	5555h	80h	5555h	AAh	2AAAh	55h	BA ⁷⁾	30h
Block Protect	6	5555h	AAh	2AAAh	55h	5555h	9Ah	5555h	AAh	2AAAh	55h	5555h	9Ah
Block Erase Suspend	Addr : V _{IH} or V _{IL} , Data : B0h												
Block Erase Resume	Addr : V _{IH} or V _{IL} , Data : 30h												

Notes :

The system should generate the following address patterns ;
5555h or 2AAAh to addresses A14 to A0.

- 1) RA : Read Address
- 2) RD : Read Data
- 3) IA : ID Addresss (A6, A1, A0)
00h = Manufacturer Code
01h = Device Code
02h = Verify Block Protect (A18 to A13 = Block Address)

4) ID : ID Data

- 98h – Manufacturer Code
- 3Bh – Device Code (TC58FVT004)
- BAh – Device Code (TC58FVB004)
- 01h – Protected Block
- 00h – Unproteted Block

- 5) PA : Proram Address
- 6) PD : Program Data
- 7) BA : Block Address

HARDWARE STATUS FLAGS

STATUS		DQ7	DQ6	DQ5	DQ3	RDY/BSY
In Progress	Auto Programming	$\overline{DQ7}$	Toggle	0	0	0
	Auto Erase (Erase Hold Time)	0	Toggle	0	0	0
	Auto Erase	0	Toggle	0	1	0
Exceeded Time Limits	Auto Programming	$\overline{DQ7}$	Toggle	1	1	0
	Auto Erase	0	Toggle	1	1	0

- Notes :
- 1. DQ outputs a cell data and RDY/BSY outputs 1 when the operation has completed.
 - 2. DQ0, DQ1, DQ2 pins are reserved for future use.
 - 3. DQ0 to DQ2, DQ4 : Output 0.

BLOCK ERASE ADDRESS TABLES

TC58FVT004 (Top Boot Block)

BLOCK#	A18	A17	A16	A15	A14	A13	ADDRESS RANGE	SIZE
BA0	L	L	L	*	*	*	00000h - 0FFFFh	64 K byte
BA1	L	L	H	*	*	*	10000h - 1FFFFh	64 K byte
BA2	L	H	L	*	*	*	20000h - 2FFFFh	64 K byte
BA3	L	H	H	*	*	*	30000h - 3FFFFh	64 K byte
BA4	H	L	L	*	*	*	40000h - 4FFFFh	64 K byte
BA5	H	L	H	*	*	*	50000h - 5FFFFh	64 K byte
BA6	H	H	L	*	*	*	60000h - 6FFFFh	64 K byte
BA7	H	H	H	L	*	*	70000h - 77FFFh	32 K byte
BA8	H	H	H	H	*	L	78000h - 79FFFh	8 K byte
BA9	H	H	H	H	L	H	7A000h - 7BFFFh	8 K byte
BA10	H	H	H	H	H	*	7C000h - 7FFFFh	16 K byte

TC58FVB004 (Bottom Boot Block)

BLOCK#	A18	A17	A16	A15	A14	A13	ADDRESS RANGE	SIZE
BA0	L	L	L	L	L	*	00000h - 03FFFh	16 K byte
BA1	L	L	L	L	H	L	04000h - 05FFFh	8 K byte
BA2	L	L	L	L	H	H	06000h - 07FFFh	8 K byte
BA3	L	L	L	H	*	*	08000h - 0FFFFh	32 K byte
BA4	L	L	H	*	*	*	10000h - 1FFFFh	64 K byte
BA5	L	H	L	*	*	*	20000h - 2FFFFh	64 K byte
BA6	L	H	H	*	*	*	30000h - 3FFFFh	64 K byte
BA7	H	L	L	*	*	*	40000h - 4FFFFh	64 K byte
BA8	H	L	H	*	*	*	50000h - 5FFFFh	64 K byte
BA9	H	H	L	*	*	*	60000h - 6FFFFh	64 K byte
BA10	H	H	H	*	*	*	70000h - 7FFFFh	64 K byte

* : V_{IH} or V_{IL}

ABSOLUTE MAXIMUM RATINGS

SYMBOL	PARAMETER	RANGE	UNIT
V_{DD}	V_{DD} Supply Voltage	-0.6 to 4.6	V
V_{IN}	Input Voltage	-0.6 to $V_{DD} + 0.5$ (≤ 4.6)	V
V_{DQ}	Input/Output Voltage	-0.6 to $V_{DD} + 0.5$ (≤ 4.6)	V
P_D	Power Dissipation	0.6	W
T_{SOLDER}	Soldering Temperature (10 s)	260	°C
T_{STG}	Storage Temperature	-55 to 150	°C
T_{OPR}	Operating Temperature	-40 to 85	°C
N_{EW}	Erase/Program Cycling Capability	100,000	Cycles
V_{IDH}	Maximum Input Voltage ¹⁾	13.0	V
I_{OSHORT}	Output Short Circuit Current ²⁾	100	mA

1) V_{IDH} supply for more than 10 seconds is not recommended. The device could be damaged.

2) Outputs should be shorted for no more than one second.
No more than one output should be shorted at a time.

CAPACITANCE (Ta = 25°C, f = 1 MHz)

SYMBOL	PARAMETER	CONDITION	TYP.	MAX	UNIT
C_{IN}	Input Pin Capacitance	$V_{IN} = 0\text{ V}$	4	8	pF
C_{OUT}	Output Pin Capacitance	$V_{OUT} = 0\text{ V}$	10	12	pF
C_{IN2}	Control Pin Capacitance	$V_{IN} = 0\text{ V}$	8	10	pF

This parameter is periodically sampled and is not tested for every device.

RECOMMENDED DC OPERATING CONDITIONS (Ta = -40 to 85°C)

SYMBOL	PARAMETER	MIN	MAX	UNIT
V_{DD}	V_{DD} Supply Voltage	2.7	3.6	V
V_{IH}	Input High Level Voltage	0.7 V_{DD}	$V_{DD} + 0.5$	
V_{IL}	Input Low Level Voltage	-0.3 ¹⁾	0.8	
V_{ID}	Voltage for ID Read and Block Protect ²⁾	11.4	12.6	

1) -2 V (pulse width of 20 ns Max)

2) V_{IDH} supply for more than 10 seconds is not recommended. The device could be damaged.

DC CHARACTERISTICS (Ta = -40 to 85°C, V_{DD} = 2.7 to 3.6 V)

SYMBOL	PARAMETER	CONDITION	MIN	MAX	UNIT
I _{LI}	Input Leakage Current	0 V ≤ V _{IN} ≤ V _{DD}	-	± 1	μA
I _{LO}	Output Leakage Current	0 V ≤ V _{OUT} ≤ V _{DD}	-	± 1	
V _{OH1}	Output High Voltage (TTL)	I _{OH} = -0.4 mA	2.4	-	V
V _{OH2}	Output High Voltage (CMOS)	I _{OH} = -0.1 mA	V _{DD} - 0.4	-	
		I _{OH} = -2.5 mA	0.85 × V _{DD}	-	
V _{OL}	Output Low Voltage	I _{OL} = 4.0 mA	-	0.4	
I _{DDO1}	V _{DD} Average Read Current	V _{IN} = V _{IH} / V _{IL} , I _{OUT} = 0 mA CYCLE = t _{RC} (min)	-	30	mA
I _{DDO2}	V _{DD} Average Program Current	V _{IN} = V _{IH} / V _{IL} , I _{OUT} = 0 mA	-	40	
I _{DDO3}	V _{DD} Average Erase Current	V _{IN} = V _{IH} / V _{IL} , I _{OUT} = 0 mA	-	40	
I _{DDS1}	V _{DD} Standby Current (TTL)	$\overline{CE} = \overline{RESET} = V_{IH}$ or $\overline{RESET} = V_{IL}$	-	250	μA
I _{DDS2}	V _{DD} Standby Current (CMOS)	$\overline{CE} = \overline{RESET} = V_{DD} \pm 0.2 V$ or $\overline{RESET} = V_{SS} \pm 0.2 V$	-	10	
I _{ID}	High Voltage Input Current	11.4 V ≤ V _{ID} ≤ 12.6 ¹⁾	-	200	
V _{LKO}	Low V _{DD} Lock-out Voltage	-	-	2.5	V

1) Less than 10 seconds

AC TEST CONDITIONS

PARAMETER	CONDITION
Input Pulse Level	2.4 V / 0.4 V
Input Pulse Rise and Fall Time (10% to 90%)	5 ns
Timing Measurement Reference Level (Input)	1.5 V / 1.5 V
Timing Measurement Reference Level (Output)	1.5 V / 1.5 V
Output Load	C _L (100 pF) + 1 TTL Gate

AC CHARACTERISTICS AND OPERATING CONDITIONS

SYMBOL	PARAMETER	-85		-10		-12		UNIT
		Ta = -40 to 85 °C						
		V _{DD} = 3.0 to 3.6 V		V _{DD} = 2.7 to 3.6 V				
		MIN	MAX	MIN	MAX	MIN	MAX	
t _{RC}	Read Cycle Time	85	–	100	–	120	–	ns
t _{ACC}	Address Access Time	–	85	–	100	–	120	ns
t _{CE}	\overline{CE} Access Time	–	85	–	100	–	120	ns
t _{OE}	\overline{OE} Access Time	–	35	–	40	–	50	ns
t _{CEE}	\overline{CE} to Output Low-Z	0	–	0	–	0	–	ns
t _{OEE}	\overline{OE} to Output Low-Z	0	–	0	–	0	–	ns
t _{OEH}	\overline{OE} Hold Time (Read)	0	–	0	–	0	–	ns
t _{OH}	Output Data Hold Time	0	–	0	–	0	–	ns
t _{DF1}	\overline{CE} to Output High-Z	–	30	–	30	–	30	ns
t _{DF2}	\overline{OE} to Output High-Z	–	30	–	30	–	30	ns
t _{CMD}	Command Write Cycle Time	85	–	100	–	120	–	ns
t _{AS}	Address Setup Time	0	–	0	–	0	–	ns
t _{AH}	Address Hold Time	45	–	50	–	50	–	ns
t _{DS}	Data Setup Time	45	–	50	–	60	–	ns
t _{DH}	Data Hold Time	0	–	0	–	0	–	ns
t _{WELH}	\overline{WE} Low Level Hold Time *	45	–	50	–	50	–	ns
t _{WEHH}	\overline{WE} High Level Hold Time *	20	–	20	–	20	–	ns
t _{CES}	\overline{CE} Setup Time to \overline{WE} Active *	0	–	0	–	0	–	ns
t _{CEH}	\overline{CE} Hold Time from \overline{WE} High Level *	0	–	0	–	0	–	ns
t _{OES}	\overline{OE} Setup to \overline{WE} Active	0	–	0	–	0	–	ns
t _{OEHP}	\overline{OE} Hold Time (Toggle / Data Polling)	10	–	10	–	10	–	ns
t _{OEHT}	\overline{OE} High Level Hold Time (Toggle)	20	–	20	–	20	–	ns
t _{PPW}	Auto Program Time	16 **	–	16 **	–	16 **	–	μs
t _{PCEW}	Auto Chip Erase Time	15 **	–	15 **	–	15 **	–	s
t _{PBEW}	Auto Block Erase Time	1.5 **	–	1.5 **	–	1.5 **	–	s
t _{VDS}	V _{DD} Setup Time	500	–	500	–	500	–	μs
t _{BUSY}	Program / Erase Valid to RDY / BSY Delay	35	–	40	–	50	–	ns
t _{RP}	RESET Low Level Hold Time	500	–	500	–	500	–	ns
t _{READY}	RESET Low Level to Read Mode	–	20	–	20	–	20	μs
t _{RB}	RDY / BSY Recovery Time	0	–	0	–	0	–	ns
t _{RH}	RESET Recovery Time	500	–	500	–	500	–	ns
t _{CEBTS}	\overline{CE} Setup time BYTE Transition	5	–	5	–	5	–	ns
t _{BTD}	BYTE to Output High-Z	–	30	–	30	–	30	ns
t _{VPT}	V _{ID} Transition Time	4	–	4	–	4	–	μs
t _{VPS}	V _{ID} Setup Time	4	–	4	–	4	–	μs
t _{VPH}	\overline{OE} Hold Time (Block Protect)	8	–	8	–	8	–	μs
t _{PPLH}	\overline{WE} Low Level Hold Time (Block Protect)	100	–	100	–	100	–	μs
t _{PAS}	Protect Address Setup Time	0	–	0	–	0	–	ns
t _{PAH}	Protect Address Hold Time	0	–	0	–	0	–	ns
t _{CESP}	\overline{CE} Setup Time (Block Protect)	4	–	4	–	4	–	μs
t _{CEHP}	\overline{CE} Hold Time (Block Protect)	8	–	8	–	8	–	μs

* : \overline{WE} Control ** : Typ.

OPERATING MODES

READ MODE

When the device is set to Read mode, it acts as an asynchronous ROM with an access time of 85/100/120 ns. The device is set to Read mode at power-on or when an Auto - Program / Erase operation completes. A software or hardware reset is necessary to return the device to Read mode when an Auto Program / Erase operation fails.

STANDBY MODE

There are two methods of entering Standby mode: the first involves using both $\overline{\text{CE}}$ and $\overline{\text{RESET}}$ and the second using only $\overline{\text{RESET}}$.

The first method involves using $\overline{\text{CE}}$ and $\overline{\text{RESET}}$ for mode control. If $V_{\text{DD}} \pm 0.2$ V (CMOS level) is applied to $\overline{\text{CE}}$ and $\overline{\text{RESET}}$ when the device is operating in Read mode, the current is reduced below 10 μA . Similarly, if V_{IH} (TTL level) is applied to $\overline{\text{CE}}$ and $\overline{\text{RESET}}$, the current is reduced below 250 μA . When using $\overline{\text{CE}}$ for control, make sure that the device is operating in Read mode; otherwise, it is not possible to enter Standby mode.

The second method involves using only $\overline{\text{RESET}}$ for mode control. If $V_{\text{SS}} \pm 0.2$ V (CMOS level) is applied to $\overline{\text{RESET}}$ when the device is operating in Read mode, the current is reduced below 10 μA . Similarly, if V_{IL} (TTL level) is applied to $\overline{\text{RESET}}$, the current is reduced below 250 μA . The difference the control method using $\overline{\text{CE}}$ described above, is that if V_{IL} is applied to $\overline{\text{RESET}}$ when the device is operating in any mode other than Read mode, it enters Standby mode after stopping the operating which is currently being executed. This is a hardware reset and is described later.

In standby mode, DQ is put in high-impedance state.

COMMAND WRITE

The TC58FVT004/B004 utilizes the JEDEC command control standard for a single power supply E²PROM. A command is executed by inputting an address and data into the Command register. The command is entered by a $\overline{\text{WE}}$ Control Write ($\overline{\text{WE}}$ pulse with $\overline{\text{CE}} = V_{\text{IL}}$ and $\overline{\text{OE}} = V_{\text{IH}}$) or a $\overline{\text{CE}}$ Control Write ($\overline{\text{CE}}$ pulse with $\overline{\text{WE}} = V_{\text{IL}}$ and $\overline{\text{OE}} = V_{\text{IH}}$). The address is latched on the falling edge of either $\overline{\text{WE}}$ or $\overline{\text{CE}}$. The data is latched on the rising edge of either $\overline{\text{WE}}$ or $\overline{\text{CE}}$.

A command is when the Reset command is input. The device then enters Read Mode. When an undefined command is input, the Command register is reset and the device enters Read mode.

RESET (Software Reset)

The device does not enter Read mode automatically when a command such as Auto Program / Erase or ID Read is not correctly executed (for example, if Program or Erase fails). The Reset or Read Command is necessary to return the device to Read mode. The Reset and Read commands must also be used to reset the Command register.

RESET (Hardware Reset)

A hardware reset is used for aborting Auto mode operations such as Auto Program / Erase and for resetting the operation mode. The device enters Read mode 20 μs after a 500-ns Low level input pulse to the $\overline{\text{RESET}}$ pin. Data may be corrupted if the device is reset during an Auto mode operation.

After a hardware reset the device enters Read mode when $\overline{\text{RESET}} = V_{\text{IH}}$ and Standby mode when $\overline{\text{RESET}} = V_{\text{IL}}$. The DQ pins are High-Impedance when $\overline{\text{RESET}} = V_{\text{IL}}$. The Read operation sequence and input of any command are allowed after the device enters Read mode.

ID READ MODE

The ID Read mode is used to establish the device type. The ID Read mode is set either from the Command mode by inputting a 90H command or from the EPROM mode by applying V_{ID} to the A9 pin.

When A0, A1 and A6 = V_{IL} , the data that is read is the manufacturer code (0098H). When A0 = V_{IH} and A1 and A6 = V_{IL} , the data that is read is the device code (4FH). The access time for an ID Read is the same as that of a normal Read operation. A reset command is necessary to return the device to Read mode from command mode. And applying V_{IH} to the A9 pin is necessary to return the device to Read mode from EPROM mode.

AUTO PROGRAM MODE

The TC58FVT004/B004 can be programmed in either byte or word units. The Auto Program mode is set using the Program command. The program address is latched on the falling edge of the $\overline{\text{WE}}$ signal and data is latched on the rising edge of the fourth bus cycle. Auto programming starts on the rising edge of the $\overline{\text{WE}}$ signal in the fourth bus cycle. The Program and Program Verify commands are automatically executed by the chip. The device status during programming is determined from the Hardware Sequence flag.

Programming of a protected block is ignored. The device enters Read mode 3 μs after the rising edge of the $\overline{\text{WE}}$ signal in the fourth bus cycle.

The device allows the programming of memory cells from 1 to 0. The programming of Memory cells from 0 to 1 will fail. A cell must be erased to turn it from 0 to 1.

If an Auto Program operation fails, the device remains in programming state and does not automatically return to Read mode. The device status can be determined from the setting of the Hardware Sequence flag. Either a Reset command or a hardware reset is necessary to return the device to Read mode after a failure.

If a programming operation fails, please do not try to use the block which contains the address to which data could not be programmed.

Auto Chip Erase Mode

The Auto Chip Erase mode is set using the Chip Erase command. The Auto Chip Erase operation starts on the rising edge of $\overline{\text{WE}}$ in the sixth bus cycle. All memory cells are automatically preprogrammed to 0, erased and verified as erased by the chip. The device status is determined from the Hardware Sequence flag.

Command inputs are ignored during an Auto Chip Erase. The hardware reset allows interruption of an Auto Chip Erase operation. The Auto Chip Erase operation does not complete correctly when interrupted. Hence a further Erase operation is necessary.

An attempt to erase a protected block is ignored. If all blocks are protected, the Auto Erase operation will not be executed and the device will enter Read mode 100 μs after the rising edge of the $\overline{\text{WE}}$ signal in the sixth bus cycle.

If an Auto Chip Erase operation fails, the device remains in, erasing state and does not return to Read mode. The device status is determined from the Hardware Sequence flag. Either a Reset command or a hardware reset is necessary to return the device to Read mode after a failure.

Auto Block / Multi Block Erase Mode

The Auto Block and Multi Block Erase modes are set using the Block Erase command. The block address is latched on the falling edge of the \overline{WE} signal in the sixth bus cycle. The Block Erase starts as soon as the hold time has elapsed after the rising edge of the \overline{WE} signal. All memory cells in the selected block are automatically programmed to 0, erased and verified as erased by the chip. The Multi Block Erase operation allows erasing of multiple blocks. Any additional block addresses or Multi Block Erase commands must be input within the Erase Hold Time - that is, within 50 μs of any \overline{WE} signal rising edge. The device status can be determined from the setting of the Hardware Sequence flag.

Commands (except Erase Suspend) are ignored during a Block/Multi Block Erase operation. The operation can be aborted by a hardware reset. The Auto Erase operation does not complete correctly when aborted, therefore, a further Erase operation is necessary.

An attempt to erase a protected block is ignored. If all the selected blocks are protected, the Auto Erase operation is not executed and the device returns to Read mode 100 μs after the rising edge of the \overline{WE} signal in the last bus cycle.

If an Auto Erase operation fails, the device remains in erasing state and does not return to Read mode. The device status is determined from the Hardware Sequence flag. Either a Reset command or a hardware reset is necessary to return the device to Read mode after a failure.

Erase Suspend / Resume Mode

The Erase Suspend mode is used to read data from a block not selected for erasing. The Erase Suspend command is allowed during a Block Erase operation or during the Block Erase Hold Time; it is ignored in other operation modes. A Block Erase operation is also suspended if the Suspend command is input during the Block Erase Hold Time. The device is reset if any command other than Suspend is input. The suspended device recognizes only Read and Resume commands.

The device enters Suspend mode 15 μs after the Erase Suspend command is input. The device then enters a pseudo-Read Mode. Data can be read out from an unselected block but is invalid if the address is set to a block selected for erasing. The device status can be determined from the Hardware Sequence flag. DQ6 (the toggle bit) stops toggling and $\text{RDY}/\overline{\text{BSY}}$ outputs 1 once the device is set to pseudo-Read mode. The host processor must track the current device mode since there is no way of telling whether the device is in pseudo-or ordinary Read mode. The device remains in pseudo-Read mode even if a Suspend command is input.

The device restarts the Block Erase operation after receiving a Resume command. The device returns to the status in which the Suspend command was input. The DQ6 output toggles and $\text{RDY}/\overline{\text{BSY}}$ outputs a 0.

BLOCK PROTECT

The TC58FVT004/B004 has a block protection feature to prevent programming and erasing of protected blocks. Block protection is enabled by either hardware protection (1) or a software command mode (2). The initial device is shipped with all blocks unprotected.

- (1) A block is protected when: $A9 = \overline{OE} = V_{ID}$, $\overline{CE} = V_{IL}$, $A0 / A6 = V_{IL}$, $A1 = V_{IH}$; the block address is set using A12 to A18. The block protect data is programmed within t_{PPLH} of the \overline{WE} signal going Low.
- (2) A block can also be protected using a software command. Block protection is executed by setting the \overline{WE} signal to Low for t_{PPLH} while $\overline{CE} = V_{IL}$. After the command input in the sixth bus cycle A12 to A18 = the block address. Block protection can be verified using the Verify Block Protect command.

TEMPORARY BLOCK UNPROTECTION

The TC58FVT004/B004 has a temporary block unprotection feature which disables block protection for all protected blocks. Unprotection is enabled by applying V_{ID} to the \overline{RESET} pin. In this state any block can be programmed or erased. The device returns to the previous condition after V_{ID} is removed from the \overline{RESET} pin. That is, previously protected blocks are protected again.

VERIFY BLOCK PROTECT

The Verify Block Protect command is used to check whether a block is protected or unprotected. Verify Block Protect is enabled either through hardware (1) or by a software command (2). In Word mode 0001H is output when the block is protected and 0000H is output when it is unprotected.

- (1) Verify Block Protection is enabled when: $A9 = V_{ID}$, $A0$ and $A6 = V_{IL}$ and $A1 = V_{IH}$.
A12 to A18 = the block address.
- (2) Verify Block Protection can also be enabled using a software command.

HARDWARE SEQUENCE FLAG

The TC58FVT004/B004 has a Hardware Sequence flag which allows the device status to be determined during Auto operation. The output data is read out with the same timing as Read mode at $\overline{CE} = \overline{OE} = V_{IL}$. RDY/ \overline{BSY} outputs either High or Low.

The device re-enters the Read mode automatically after Auto operation has completed successfully. The device status is read out from the Hardware Sequence flag and the operation result is verified by comparing the read-out data to the original data.

DQ7 (DATA Polling)

The device status can be determined using the data polling function during an Auto Program or Auto Erase operation. \overline{DATA} polling begins on the rising edge of \overline{WE} in the last bus cycle. In an Auto Program operation, DQ7 outputs inverted data during the programming operation and outputs real data after programming has finished. In an Auto Erase operation, DQ7 outputs 0 during the Erase operation and outputs 1 when the Erase operation has finished. If an Auto Program operation fails, DQ7 simply outputs the data.

The latched address is reset after an operation has finished. The polling data is asynchronous with the \overline{OE} signal.

DQ6 (Toggle Bit)

The device status can be determined by the Toggle Bit function during an Auto Program or Auto Erase operation. In an Auto Program operation the Toggle bit begins toggling on the rising edge of \overline{WE} in the last bus cycle. In an Auto Erase operation The Toggle bit begins toggling as soon as the Erase Hold Time has elapsed after the rising edge of the \overline{WE} signal in the last bus cycle. DQ6 alternately outputs a 0 or a 1 for each attempt (\overline{OE} access) while $\overline{CE} = V_{IL}$ while the device is busy. When the internal operation has been completed, toggling stops and valid memory cell data can be read by subsequent reading. If the operation failed, the DQ6 output toggles.

DQ6 toggles for around 3 μs when an attempt is made to execute an Auto Program operation on a protected block. It then stops toggling. DQ6 toggles for around 100 μs when an attempt is made to execute an Auto Erase operation on a protected block. It then stops toggling. After toggling stops the device returns to Read mode.

DQ5 (Internal Time-out)

DQ5 outputs a 1 when the Internal Timer has timed out during a Program or Erase operation. This indicates that the operation has not completed within the allotted time.

An attempt to program 1 into a cell containing 0 will fail (see Auto Program mode). DQ5 outputs 1 in this case. Either a hardware reset or a software Reset command is required to put the device into Read mode.

DQ3 (Block Erase Timer)

The Block Erase operation starts 50 μ s (Erase Hold Time) after the rising edge of \overline{WE} in the last command cycle. DQ3 outputs a 0 during the Block Erase Hold Time and a 1 when the Erase operation starts. Additional Block Erase commands can only be accepted during this Block Erase Hold Time. Each Block Erase command received within this hold time resets the timer, allowing additional blocks to be marked for erasing. DQ3 outputs a 1 if the Program or Erase operation fails.

RDY/ \overline{BSY} (READY/ \overline{BUSY})

TC58FVT004/B004 has a RDY/ \overline{BSY} signal to indicate the device status to the host processor. A 0 (Busy state) indicates that an Auto Program or Auto Erase operation is in progress. A 1 (Ready state) indicates that the operation has finished and that the device can accept a new command. The RDY/ \overline{BSY} signal outputs a 0 when an operation has failed.

The RDY/ \overline{BSY} signal outputs a 0 after the rising edge of \overline{WE} in the last command cycle of a Program operation and during the Erase Hold Time after the last command cycle of an Erase operation.

During an Auto Block Erase operation, commands other than Erase Suspend are ignored. The RDY/ \overline{BSY} signal outputs a 1 during an Erase Suspend operation. The output buffer for the RDY/ \overline{BSY} pin is an open drain type circuit, allowing a wired-OR connection. A pull-up resistor needs to be inserted between V_{DD} and the RDY/ \overline{BSY} pin.

DATA PROTECTION

The TC58FVT004/B004 utilizes a JEDEC standard command sequence which protects data against accidental alteration due to noise.

V_{DD} Lock-out Voltage

The device is reset when V_{DD} is less than V_{LKO} to protect memory cell data against V_{DD} noise, and during power-up and power-down. An Auto Program or Erase operation stops when V_{DD} drops below V_{LKO} . An Erase Suspend operation is reset and an Erase operation stops if the device is in Suspend mode. An operation will not complete correctly if it is interrupted by V_{DD} Lock-out.

\overline{WE} Glitch Pulses

Glitches must be suppressed (to less than 5 ns) in order for operation to proceed smoothly.

Protection at Power-on

A command is not recognized on the rising edge of \overline{WE} if V_{DD} rises from 0 V to the operating voltage while $\overline{WE} = V_{IL}$, $\overline{CE} = V_{IL}$ and $\overline{OE} = V_{IH}$. In this case the device is reset and enters Read mode.

TIMING DIAGRAMS

Read/ID Read Operation

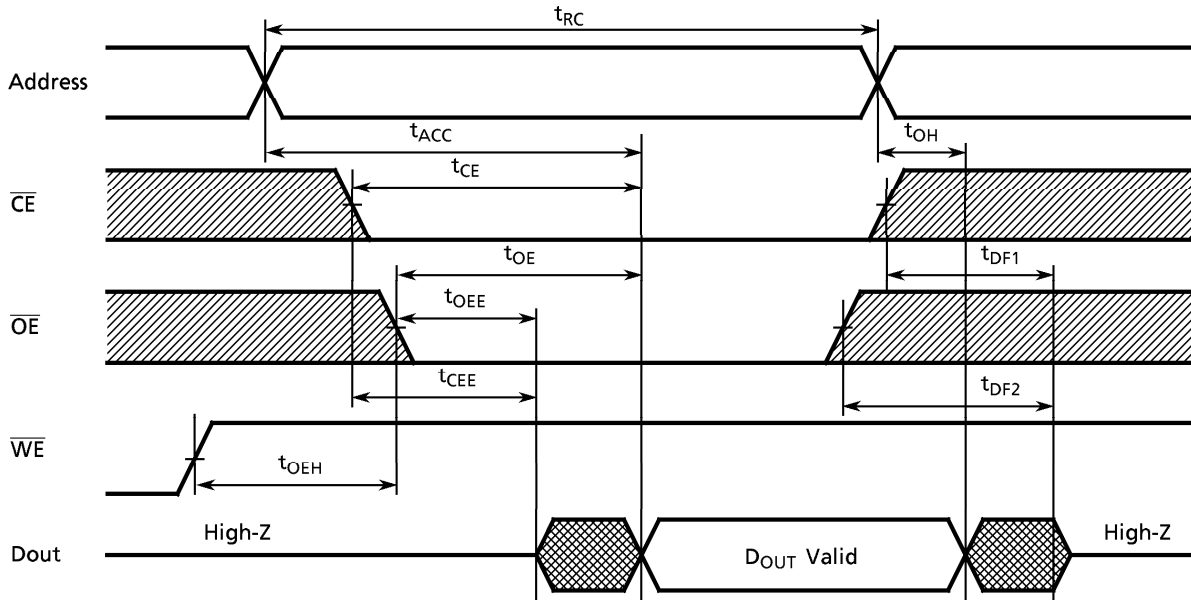

ID Read Operation (Hardware)

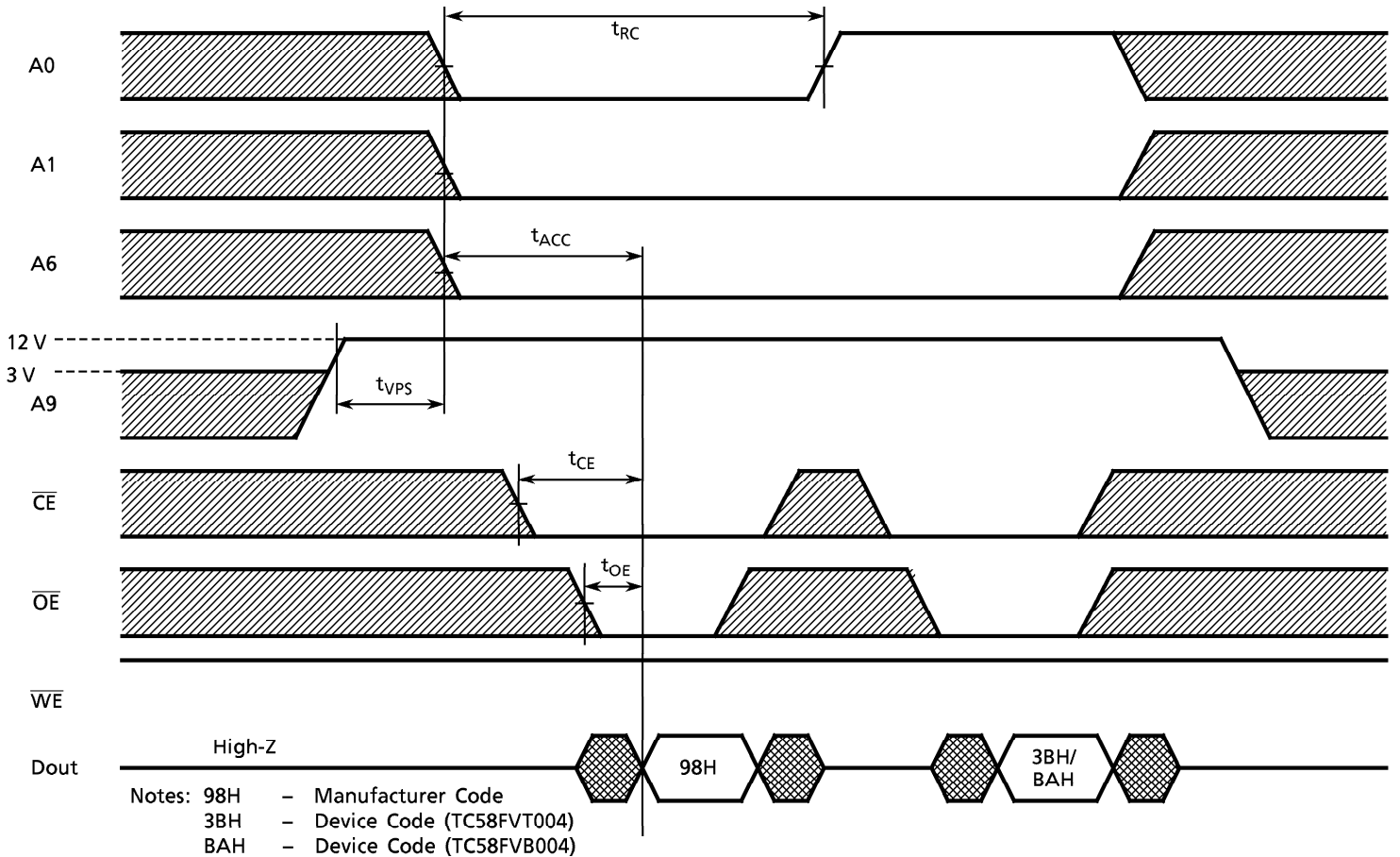

Auto Program Operation (\overline{WE} Control)

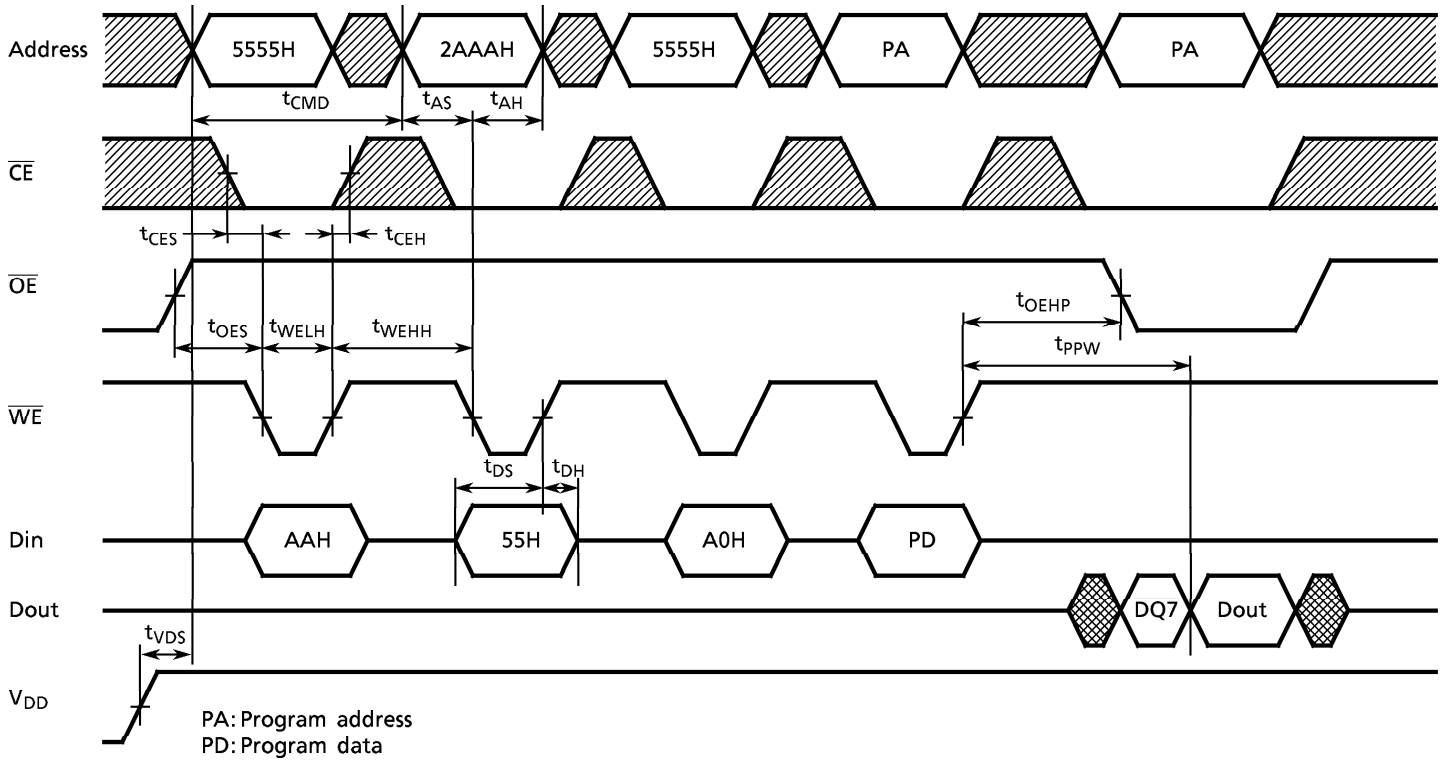

Auto Chip Erase / Auto Block Erase Operation (\overline{WE} Control)

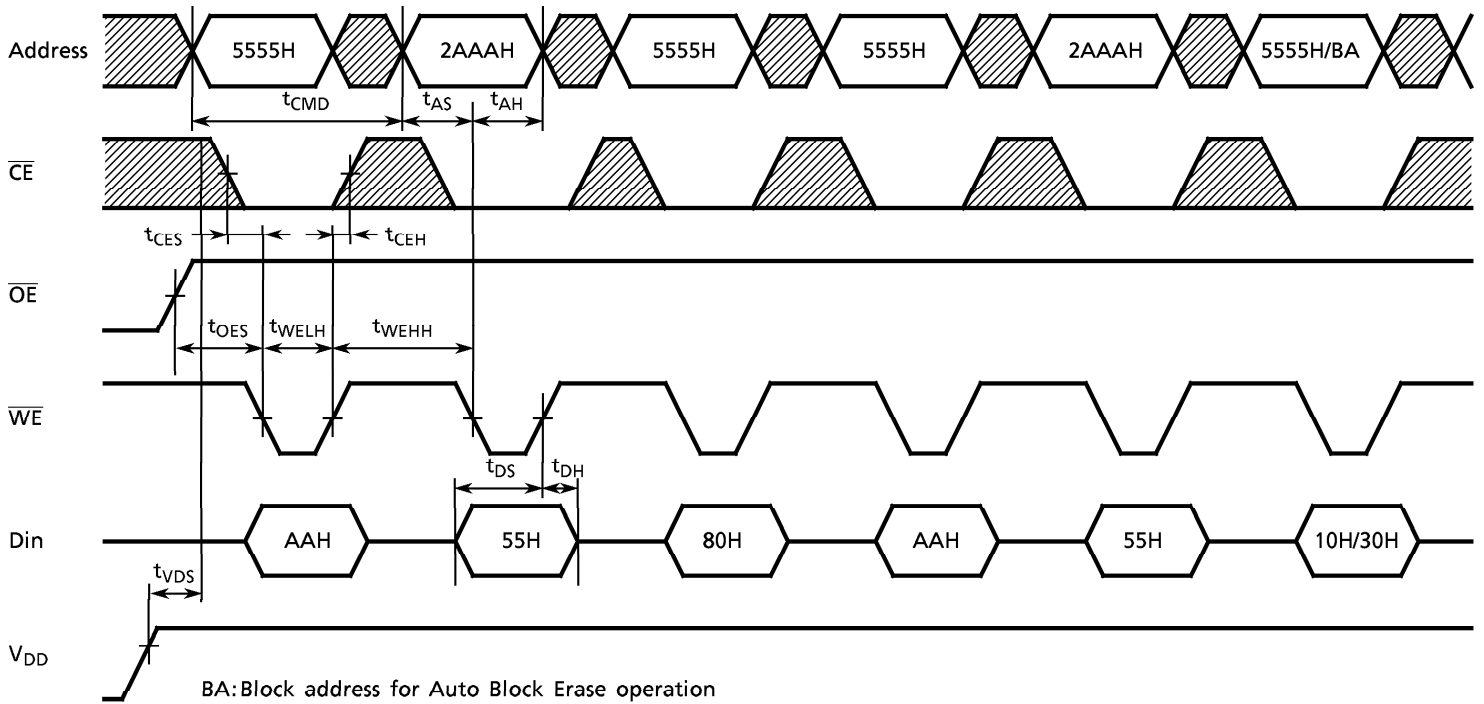

DATA Polling during Program/Erase Operation

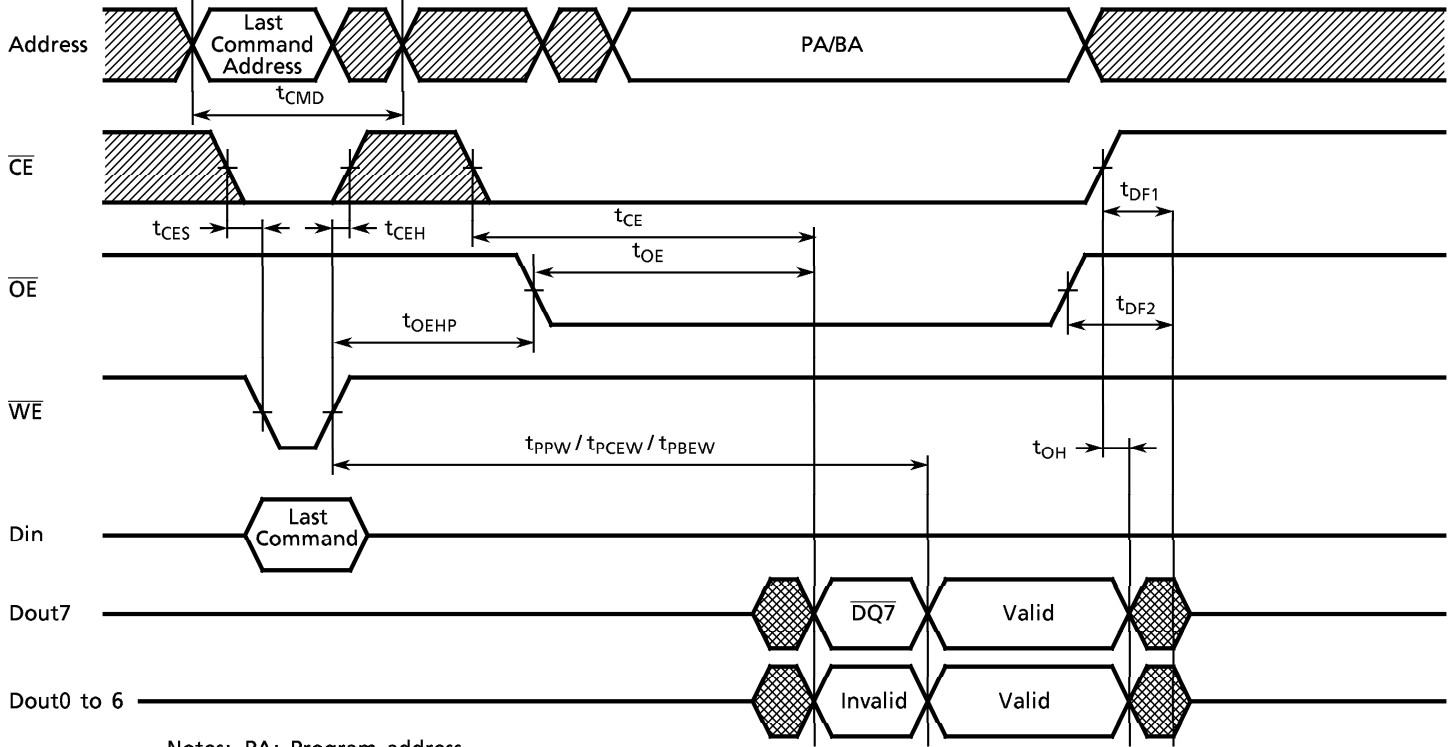

Notes: PA: Program address
BA: Block address

Toggle Bit during Program/Erase Operation

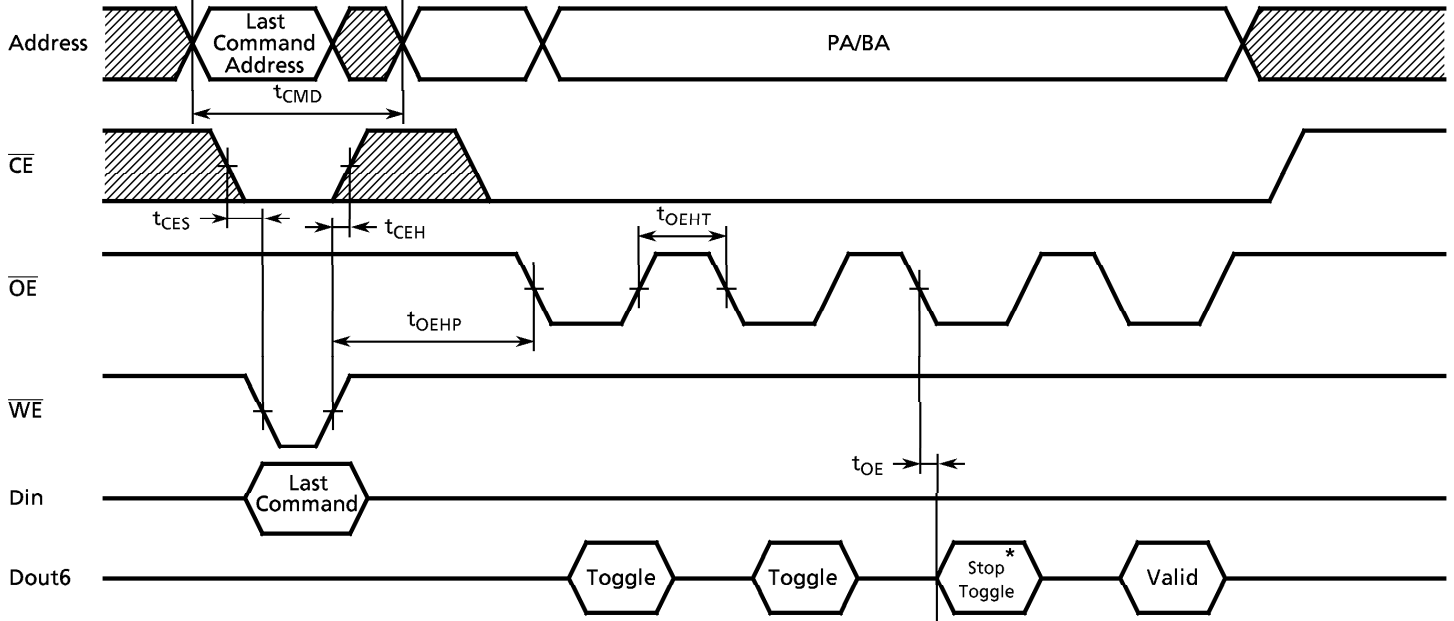

* Dout6 stops toggling when the last command has completed.

Notes: PA: Program address
BA: Block address

RDY/BSY during Auto Program/Erase Operation

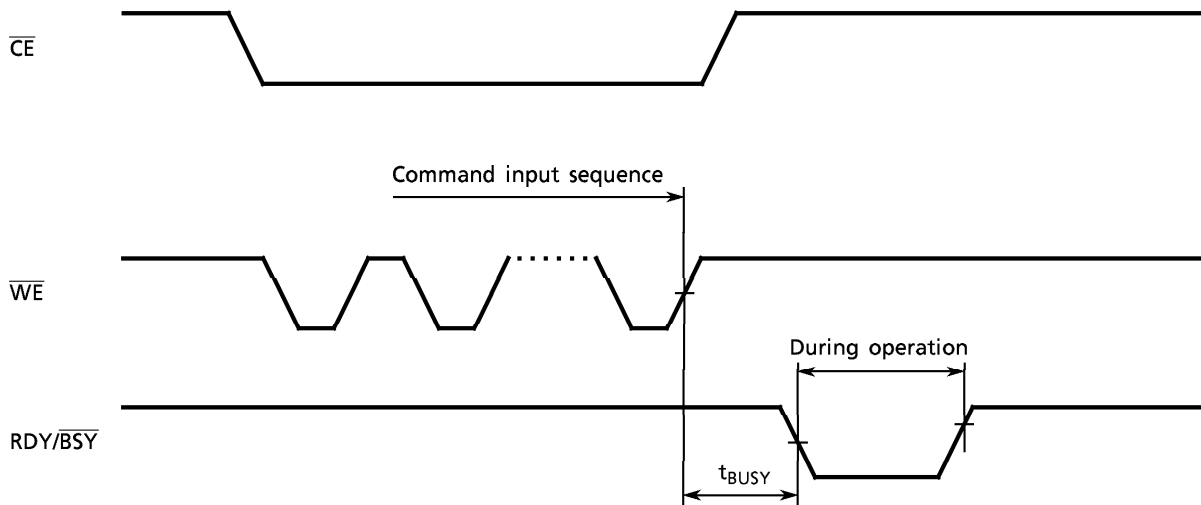

Hardware Reset Operation

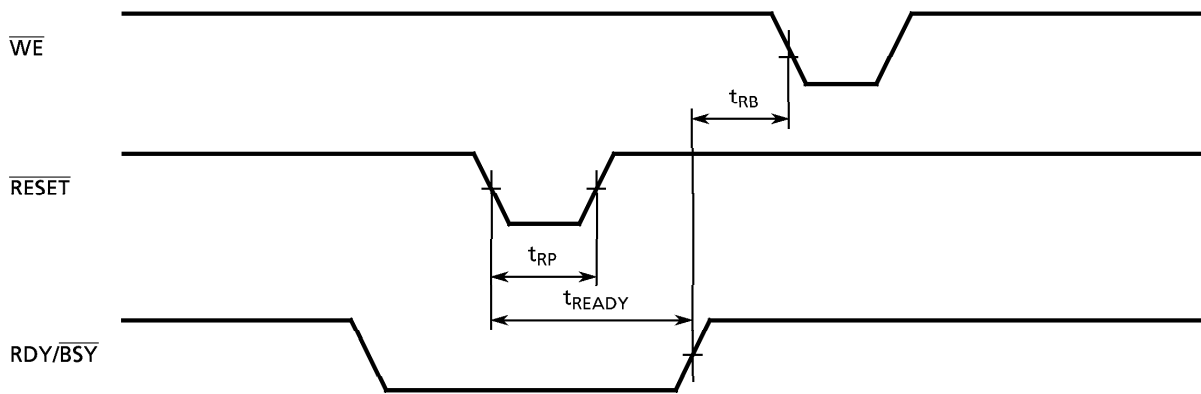

Read after \overline{RESET}

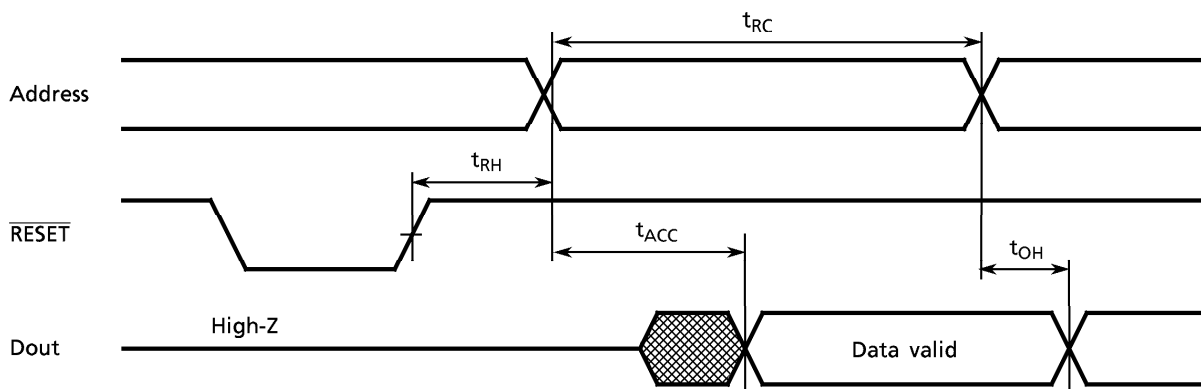

Block Protect Operation (Hardware)

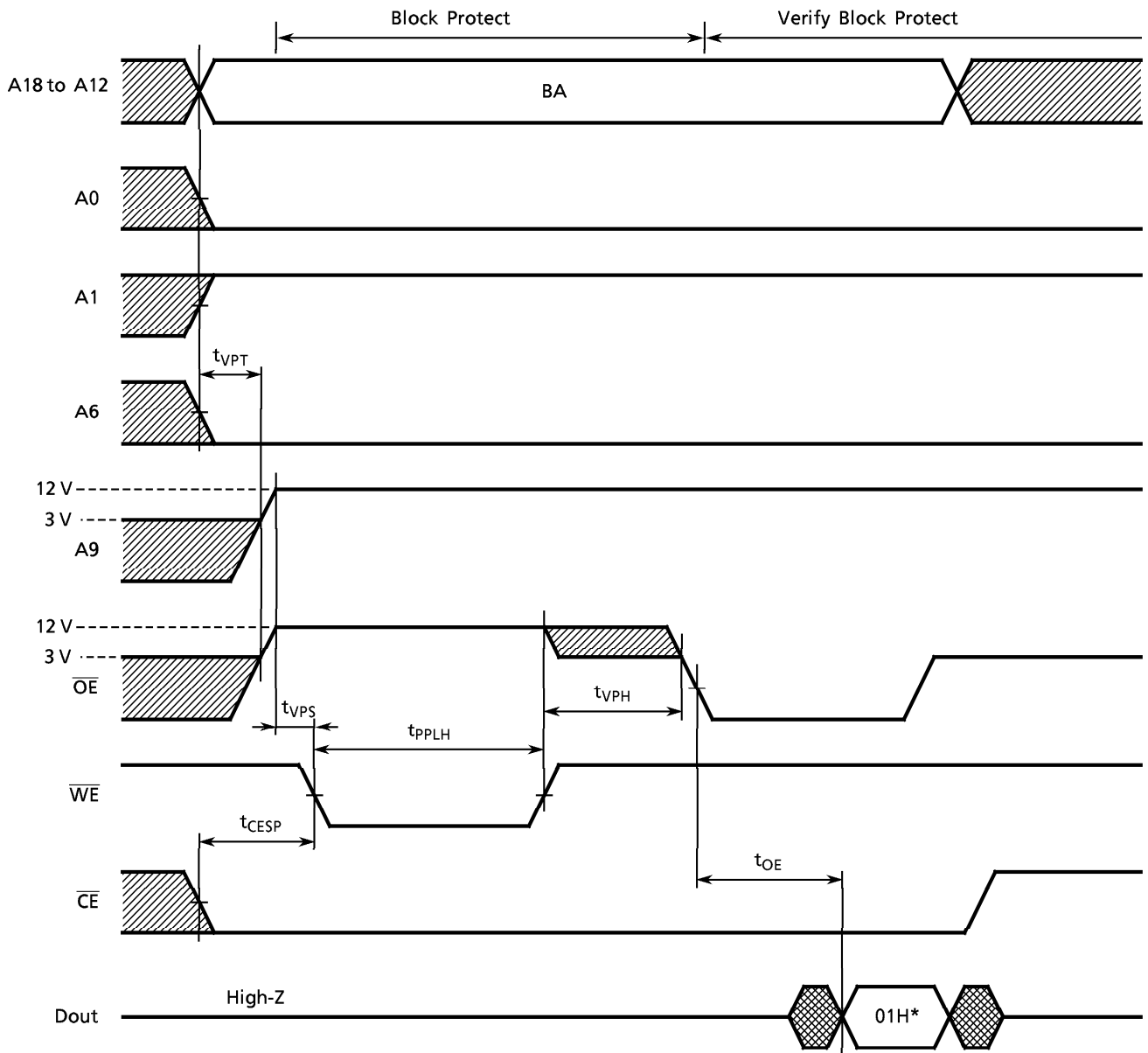

BA: Block address

* : 01H indicates that block is protected.

Block Protect (Software)

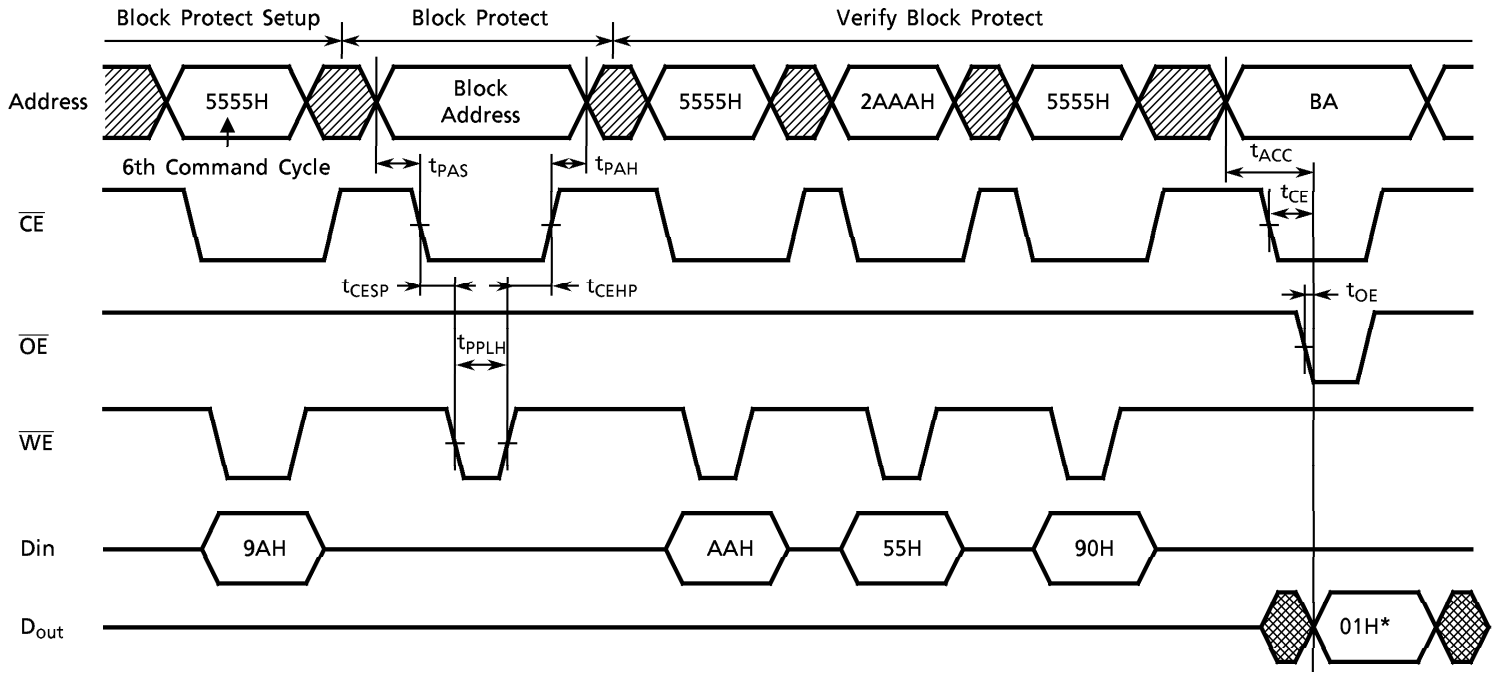

BA : Block address

* : 01H indicates that block is protected.

FLOWCHARTS

Auto Program

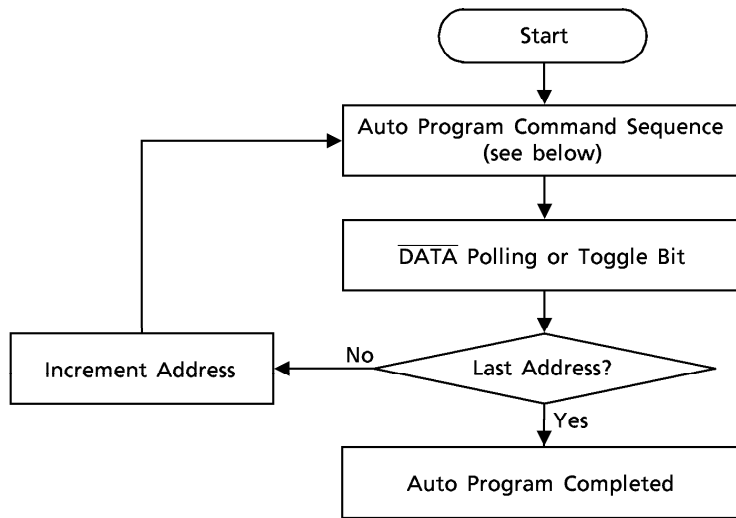

Auto Program Command Sequence (Address/Command)

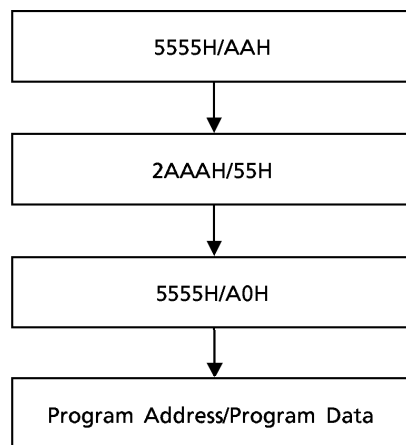

Auto Erase

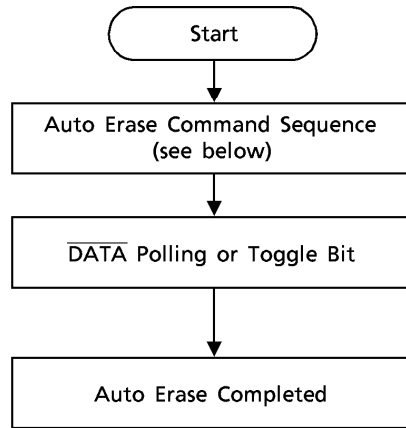

Auto Chip Erase Command Sequence
(Address/Command)

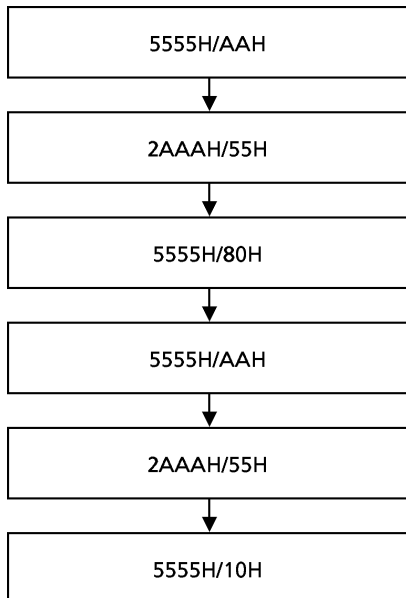

Auto Block/Multiple Block
Erase Command Sequence (Address/Command)

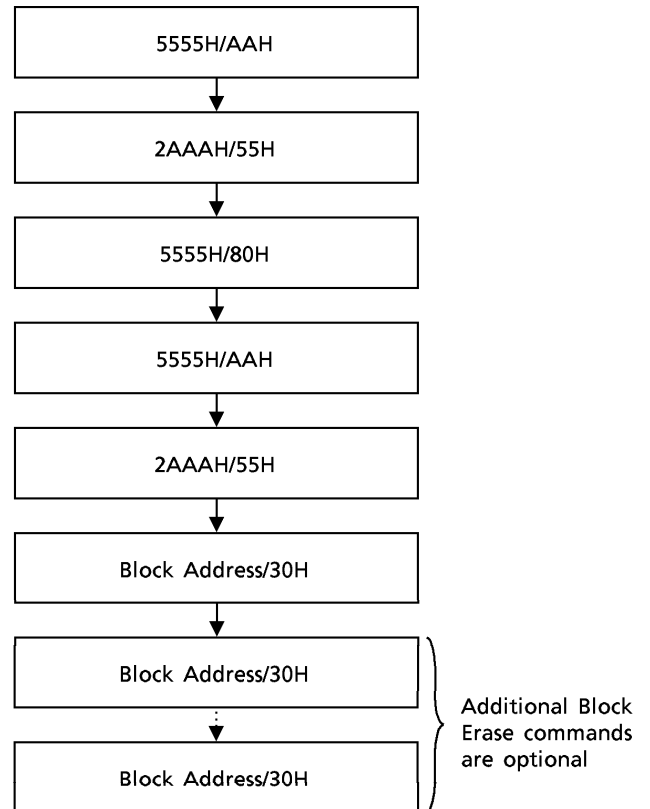

DQ7 DATA Polling

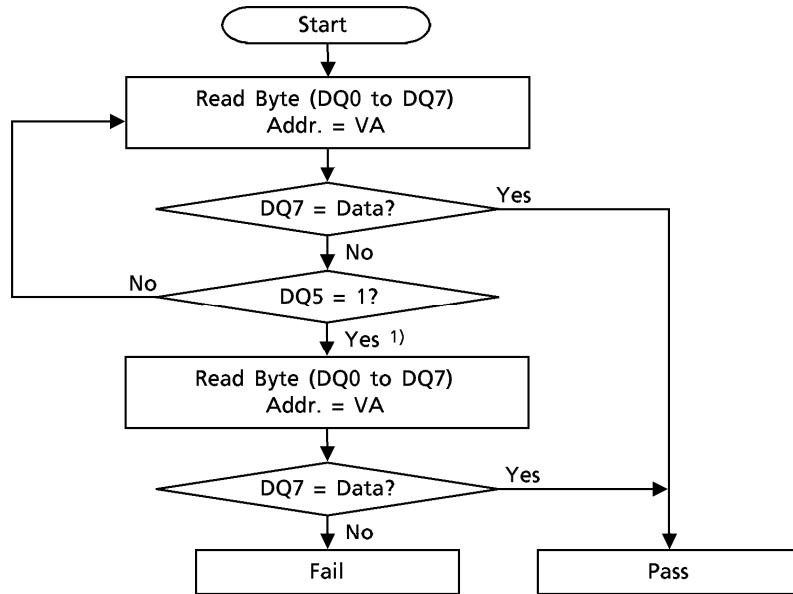

VA: Any of the addresses within the block being erased during a Block Erase operation.
Don't care during a Chip Erase operation

Note: 1) DQ7 must be rechecked even if DQ5 = 1 because DQ7 may change at the same time as DQ5.

DQ6 Toggle Bit

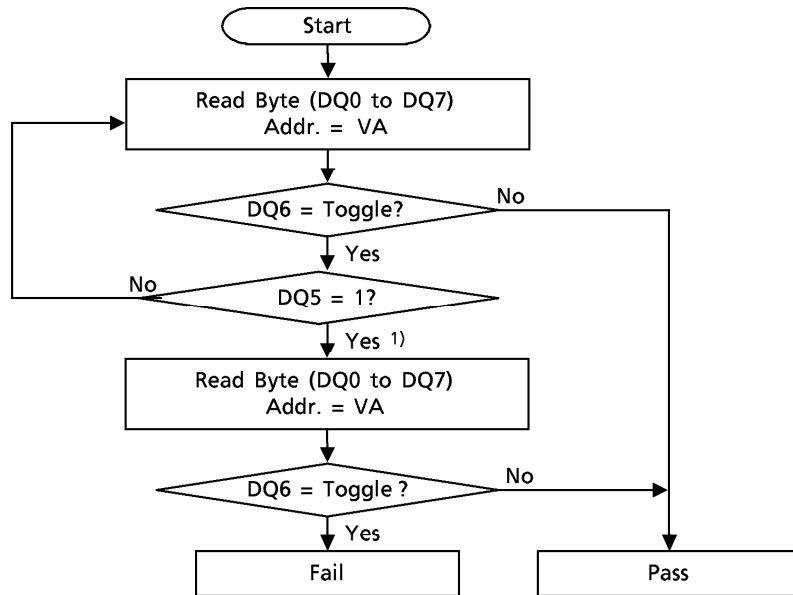

VA: Any of the addresses within the block being erased during a Block Erase operation.
Don't care during a Chip Erase operation
Any address not within the current block during an Erase Suspend operation

Note: 1) DQ6 must be rechecked even if DQ5 = 1 because DQ6 may stop toggling at the same time that DQ5 changes to 1.

Block Protect (Hardware)

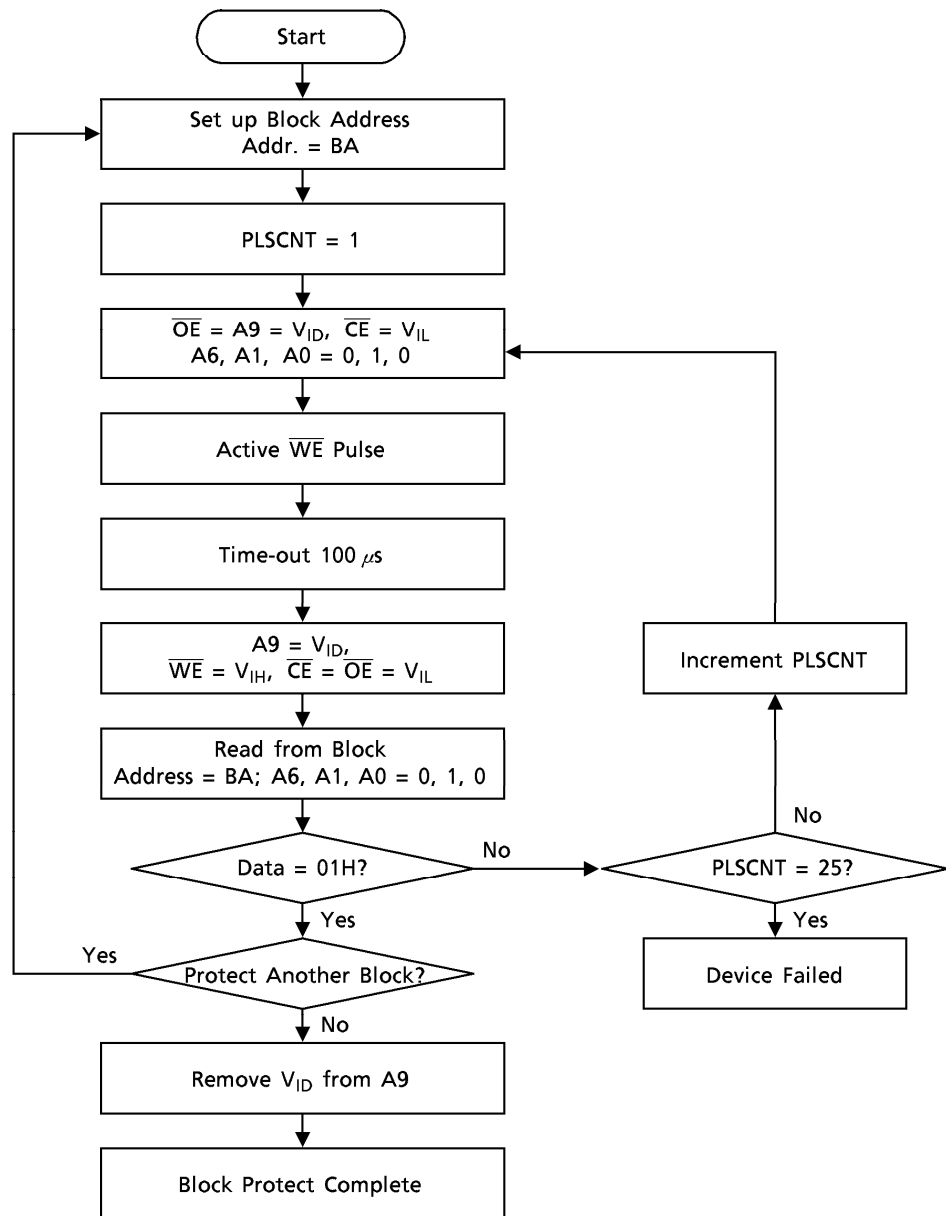

BA: Block address

Block Protect (Software)

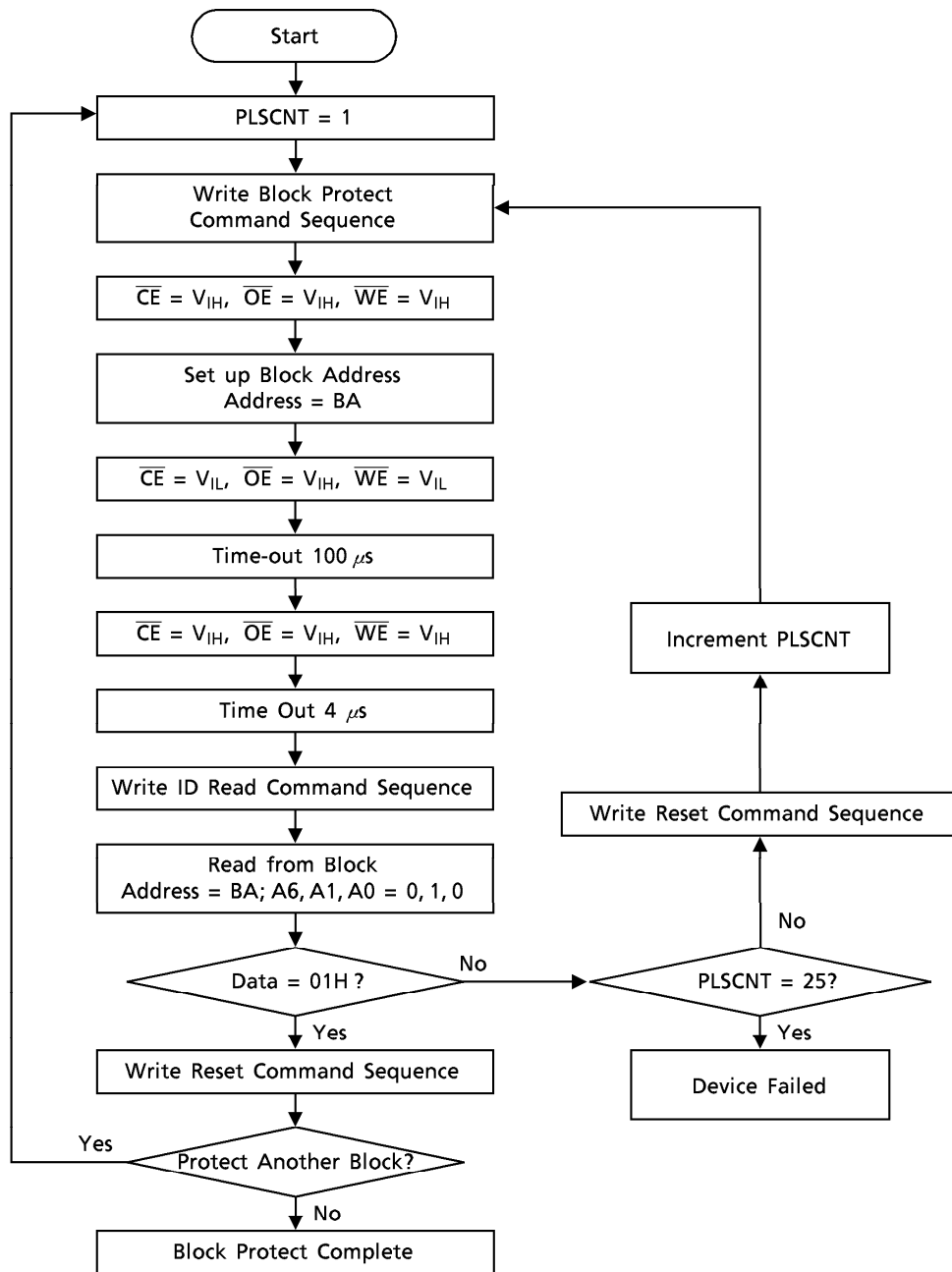

BA: Block Address

PACKAGE DIMENSIONS

- Plastic TSOP

TSOP I 40-P-1020-0.50

Unit : mm

