

TOSHIBA CMOS DIGITAL INTEGRATED CIRCUIT SILICON MONOLITHIC

**TC7MA2574FK****LOW-VOLTAGE OCTAL D-TYPE FLIP-FLOP  
WITH 3.6 V TOLERANT INPUTS AND OUTPUTS**

The TC7MA2574FK is a high performance CMOS OCTAL D-TYPE FLIP-FLOP. Designed for use in 1.8, 2.5 or 3.3 Volt systems, it achieves high speed operation while maintaining the CMOS low power dissipation.

It is also designed with over voltage tolerant inputs and outputs up to 3.6 V.

This 8 bit D-type flip-flop is controlled by a clock input (CK) and an output enable input ( $\overline{OE}$ ). When the  $\overline{OE}$  input is high, the eight outputs are in a high impedance state.

The 26- $\Omega$  series resistor helps reducing output overshoot and undershoot without external resistor.

All inputs are equipped with protection circuits against static discharge.

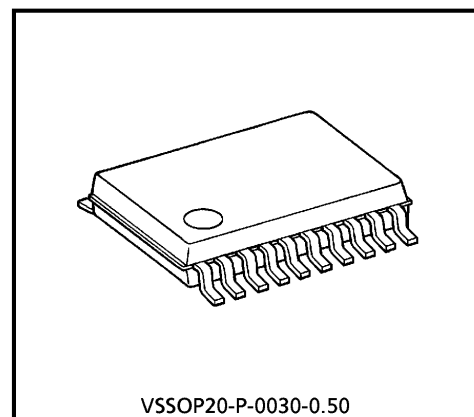

VSSOP20-P-0030-0.50

Weight : 0.03 g (typ.)

**Features**

- 26- $\Omega$  Series Resistors on Outputs.
- Low Voltage Operation :  $V_{CC} = 1.8\sim 3.6\text{ V}$
- High Speed Operation :  $t_{pd} = 5.1\text{ ns (max) at } V_{CC} = 3.0\sim 3.6\text{ V}$   
 $t_{pd} = 6.2\text{ ns (max) at } V_{CC} = 2.3\sim 2.7\text{ V}$   
 $t_{pd} = 9.8\text{ ns (max) at } V_{CC} = 1.8\text{ V}$
- 3.6 V Tolerant inputs and output.
- Output Current :  $I_{OH}/I_{OL} = \pm 12\text{ mA (min) at } V_{CC} = 3.0\text{ V}$   
 $I_{OH}/I_{OL} = \pm 8\text{ mA (min) at } V_{CC} = 2.3\text{ V}$   
 $I_{OH}/I_{OL} = \pm 4\text{ mA (min) at } V_{CC} = 1.8\text{ V}$
- Latch-up Performance :  $\pm 300\text{ mA}$
- ESD Performance : Human Body Model  $> \pm 2000\text{ V}$   
Machine Model  $> \pm 200\text{ V}$
- Package : VSSOP (US20)
- Power Down Protection is provided on all inputs and outputs.
- Supports live insertion / withdrawal (Note 1)

(Note 1): To ensure the high-impedance state during power up or power down,  $\overline{OE}$  should be tied to  $V_{CC}$  through a pullup resistor; the minimum value of the resistor is determined by the current-sourcing capability of the driver.

980910EBA1

- TOSHIBA is continually working to improve the quality and the reliability of its products. Nevertheless, semiconductor devices in general can malfunction or fail due to their inherent electrical sensitivity and vulnerability to physical stress. It is the responsibility of the buyer, when utilizing TOSHIBA products, to observe standards of safety, and to avoid situations in which a malfunction or failure of a TOSHIBA product could cause loss of human life, bodily injury or damage to property. In developing your designs, please ensure that TOSHIBA products are used within specified operating ranges as set forth in the most recent products specifications. Also, please keep in mind the precautions and conditions set forth in the TOSHIBA Semiconductor Reliability Handbook.
- The products described in this document are subject to the foreign exchange and foreign trade laws.
- The information contained herein is presented only as a guide for the applications of our products. No responsibility is assumed by TOSHIBA CORPORATION for any infringements of intellectual property or other rights of the third parties which may result from its use. No license is granted by implication or otherwise under any intellectual property or other rights of TOSHIBA CORPORATION or others.
- The information contained herein is subject to change without notice.

**Pin Assignment**

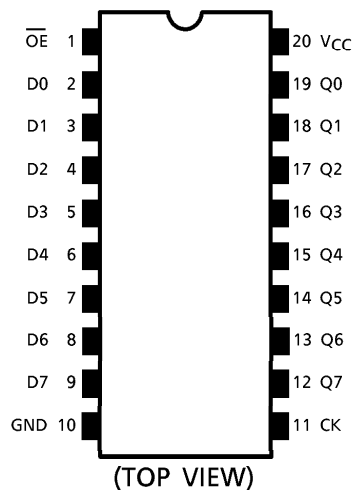

**IEC Logic Symbol**

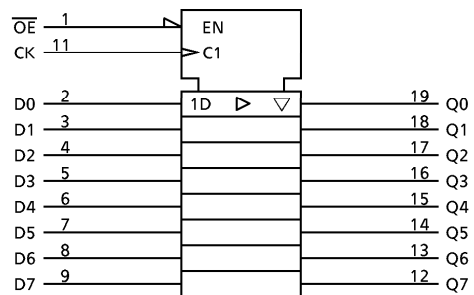

**Truth Table**

INPUTS			OUTPUTS
$\overline{OE}$	CK	D	
H	X	X	Z
L		X	Qn
L		L	L
L		H	H

X : Don't Care  
 Z : High Impedance  
 Qn : No change

**System Diagram**

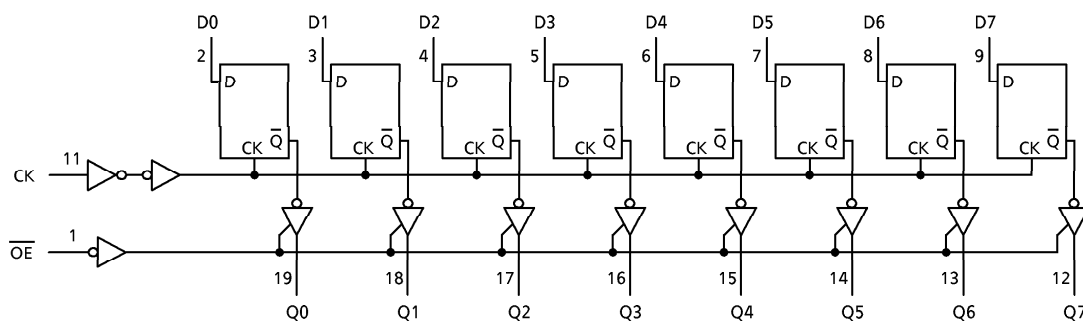

## Maximum Ratings

PARAMETER	SYMBOL	RATING	UNIT
Power Supply Voltage	$V_{CC}$	-0.5~4.6	V
DC Input Voltage	$V_{IN}$	-0.5~4.6	V
DC Output Voltage	$V_{OUT}$	-0.5~4.6 (Note 1)	V
		-0.5~ $V_{CC} + 0.5$ (Note 2)	
Input Diode Current	$I_{IK}$	-50	mA
Output Diode Current	$I_{OK}$	±50 (Note 3)	mA
DC Output Current	$I_{OUT}$	±50	mA
Power Dissipation	$P_D$	180	mW
DC $V_{CC}$ /Ground Current	$I_{CC}/I_{GND}$	±100	mA
Storage Temperature	$T_{stg}$	-65~150	°C

(Note 1): Off-State

(Note 2): High or Low State.  $I_{OUT}$  absolute maximum rating must be observed.

(Note 3):  $V_{OUT} < GND$ ,  $V_{OUT} > V_{CC}$

## Recommended Operating Range

PARAMETER	SYMBOL	RATING	UNIT
Supply Voltage	$V_{CC}$	1.8~3.6	V
		1.2~3.6 (Note 4)	
Input Voltage	$V_{IN}$	-0.3~3.6	V
Output Voltage	$V_{OUT}$	0~3.6 (Note 5)	V
		0~ $V_{CC}$ (Note 6)	
Output Current	$I_{OH}/I_{OL}$	±12 (Note 7)	mA
		±8 (Note 8)	
		±4 (Note 9)	
Operating Temperature	$T_{opr}$	-40~85	°C
Input Rise And Fall Time	$dt/dv$	0~10 (Note 10)	ns/V

(Note 4): Data Retention Only

(Note 5): Off-State

(Note 6): High or Low State

(Note 7):  $V_{CC} = 3.0\sim 3.6\text{ V}$

(Note 8):  $V_{CC} = 2.3\sim 2.7\text{ V}$

(Note 9):  $V_{CC} = 1.8\text{ V}$

(Note 10):  $V_{IN} = 0.8\sim 2.0\text{ V}$ ,  $V_{CC} = 3.0\text{ V}$

**Electrical Characteristics**

DC characteristics (Ta = -40~85°C, 2.7 V < VCC ≤ 3.6 V)

PARAMETER		SYMBOL	TEST CONDITION		Min	Max	UNIT
Input Voltage	"H" Level	V <sub>IH</sub>			2.7~3.6	2.0	V
	"L" Level	V <sub>IL</sub>			2.7~3.6	—	
Output Voltage	"H" Level	V <sub>OH</sub>	V <sub>IN</sub> = V <sub>IH</sub> or V <sub>IL</sub>	I <sub>OH</sub> = -100 μA	2.7~3.6	V <sub>CC</sub> - 0.2	V
				I <sub>OH</sub> = -6 mA	2.7	2.2	
				I <sub>OH</sub> = -8 mA	3.0	2.4	
				I <sub>OH</sub> = -12 mA	3.0	2.2	
	"L" Level	V <sub>OL</sub>	V <sub>IN</sub> = V <sub>IH</sub> or V <sub>IL</sub>	I <sub>OL</sub> = 100 μA	2.7~3.6	—	0.2
				I <sub>OL</sub> = 6 mA	2.7	—	0.4
				I <sub>OL</sub> = 8 mA	3.0	—	0.55
				I <sub>OL</sub> = 12 mA	3.0	—	0.8
Input Leakage Current		I <sub>IN</sub>	V <sub>IN</sub> = 0~3.6 V	2.7~3.6	—	± 5.0	μA
3-State Output Off-State Current		I <sub>OZ</sub>	V <sub>IN</sub> = V <sub>IH</sub> or V <sub>IL</sub> V <sub>OUT</sub> = 0~3.6 V	2.7~3.6	—	± 10.0	μA
Power Off Leakage Current		I <sub>OFF</sub>	V <sub>IN</sub> , V <sub>OUT</sub> = 0~3.6 V	0	—	10.0	μA
Quiescent Supply Current		I <sub>CC</sub>	V <sub>IN</sub> = V <sub>CC</sub> or GND	2.7~3.6	—	20.0	μA
			V <sub>CC</sub> ≤ (V <sub>IN</sub> , V <sub>OUT</sub> ) ≤ 3.6 V	2.7~3.6	—	± 20.0	
Increase In I <sub>CC</sub> Per Input		ΔI <sub>CC</sub>	V <sub>IH</sub> = V <sub>CC</sub> - 0.6 V	2.7~3.6	—	750	μA

**Electrical Characteristics**

DC characteristics (Ta = -40~85°C, 2.3 V ≤ VCC ≤ 2.7 V)

PARAMETER		SYMBOL	TEST CONDITION		Min	Max	UNIT
Input Voltage	"H" Level	V <sub>IH</sub>			2.3~2.7	1.6	V
	"L" Level	V <sub>IL</sub>			2.3~2.7	—	
Output Voltage	"H" Level	V <sub>OH</sub>	V <sub>IN</sub> = V <sub>IH</sub> or V <sub>IL</sub>	I <sub>OH</sub> = -100 μA	2.3~2.7	V <sub>CC</sub> - 0.2	V
				I <sub>OH</sub> = -4 mA	2.3	2.0	
				I <sub>OH</sub> = -6 mA	2.3	1.8	
				I <sub>OH</sub> = -8 mA	2.3	1.7	
	"L" Level	V <sub>OL</sub>	V <sub>IN</sub> = V <sub>IH</sub> or V <sub>IL</sub>	I <sub>OL</sub> = 100 μA	2.3~2.7	—	0.2
				I <sub>OL</sub> = 6 mA	2.3	—	0.4
				I <sub>OL</sub> = 8 mA	2.3	—	0.6
Input Leakage Current		I <sub>IN</sub>	V <sub>IN</sub> = 0~3.6 V	2.3~2.7	—	± 5.0	μA
3-State Output Off-State Current		I <sub>OZ</sub>	V <sub>IN</sub> = V <sub>IH</sub> or V <sub>IL</sub> V <sub>OUT</sub> = 0~3.6 V	2.3~2.7	—	± 10.0	μA
Power Off Leakage Current		I <sub>OFF</sub>	V <sub>IN</sub> , V <sub>OUT</sub> = 0~3.6 V	0	—	10.0	μA
Quiescent Supply Current		I <sub>CC</sub>	V <sub>IN</sub> = V <sub>CC</sub> or GND	2.3~2.7	—	20.0	μA
			V <sub>CC</sub> ≤ (V <sub>IN</sub> , V <sub>OUT</sub> ) ≤ 3.6 V	2.3~2.7	—	± 20.0	

**Electrical Characteristics**

DC characteristics (Ta = -40~85°C, 1.8 V ≤ VCC < 2.3 V)

PARAMETER		SYMBOL	TEST CONDITION		VCC (V)	Min	Max	UNIT
					1.8~2.3			
Input Voltage	"H" Level	V <sub>IH</sub>			1.8~2.3	0.7 × V <sub>CC</sub>	—	V
	"L" Level	V <sub>IL</sub>			1.8~2.3	—	0.2 × V <sub>CC</sub>	
Output Voltage	"H" Level	V <sub>OH</sub>	V <sub>IN</sub> = V <sub>IH</sub> or V <sub>IL</sub>	I <sub>OH</sub> = -100 μA	1.8	V <sub>CC</sub> - 0.2	—	V
				I <sub>OH</sub> = -4 mA	1.8	1.4	—	
	"L" Level	V <sub>OL</sub>	V <sub>IN</sub> = V <sub>IH</sub> or V <sub>IL</sub>	I <sub>OL</sub> = 100 μA	1.8	—	0.2	
				I <sub>OL</sub> = 4 mA	1.8	—	0.3	
Input Leakage Current		I <sub>IN</sub>	V <sub>IN</sub> = 0~3.6 V		1.8	—	± 5.0	μA
3-State Output Off-State Current		I <sub>OZ</sub>	V <sub>IN</sub> = V <sub>IH</sub> or V <sub>IL</sub> V <sub>OUT</sub> = 0~3.6 V		1.8	—	± 10.0	μA
Power Off Leakage Current		I <sub>OFF</sub>	V <sub>IN</sub> , V <sub>OUT</sub> = 0~3.6 V		0	—	10.0	μA
Quiescent Supply Current		I <sub>CC</sub>	V <sub>IN</sub> = V <sub>CC</sub> or GND		1.8	—	20.0	μA
			V <sub>CC</sub> ≤ (V <sub>IN</sub> , V <sub>OUT</sub> ) ≤ 3.6 V		1.8	—	± 20.0	

AC characteristics (Ta = -40~85°C, Input tr = tf = 2.0 ns, CL = 30 pF, RL = 500 Ω)

PARAMETER	SYMBOL	TEST CONDITION	VCC (V)	Min	Max	UNIT
Maximum Clock Frequency	fMAX	(Fig.1, 2)	1.8	100	—	MHz
			2.5 ± 0.2	200	—	
			3.3 ± 0.3	250	—	
Propagation Delay Time (CK-Q)	tpLH tpHL	(Fig.1, 2)	1.8	1.5	9.8	ns
			2.5 ± 0.2	0.8	6.2	
			3.3 ± 0.3	0.6	5.1	
3-State Output Enable Time	tpZL tpZH	(Fig.1, 3)	1.8	1.5	9.8	ns
			2.5 ± 0.2	0.8	6.5	
			3.3 ± 0.3	0.6	5.0	
3-State Output Disable Time	tpLZ tpHZ	(Fig.1, 3)	1.8	1.5	7.7	ns
			2.5 ± 0.2	0.8	4.3	
			3.3 ± 0.3	0.6	3.9	
Minimum Pulse Width (CK)	tw (H) tw (L)	(Fig.1, 2)	1.8	4.0	—	ns
			2.5 ± 0.2	1.5	—	
			3.3 ± 0.3	1.5	—	
Minimum Set-up Time	ts	(Fig.1, 2)	1.8	2.5	—	ns
			2.5 ± 0.2	1.5	—	
			3.3 ± 0.3	1.5	—	
Minimum Hold Time	th	(Fig.1, 2)	1.8	1.0	—	ns
			2.5 ± 0.2	1.0	—	
			3.3 ± 0.3	1.0	—	
Output To Output Skew	tosLH tosHL	(Note 11)	1.8	—	0.5	ns
			2.5 ± 0.2	—	0.5	
			3.3 ± 0.3	—	0.5	

For CL = 50 pF, add approximately 300 ps to the AC maximum specification.

(Note 11): Parameter guaranteed by design.

$$(tosLH = |tpLHm - tpLHn|, tosHL = |tpHLm - tpHLn|)$$

Dynamic switching characteristics ( $T_a = 25^\circ\text{C}$ , Input  $t_r = t_f = 2.0\text{ ns}$ ,  $C_L = 30\text{ pF}$ )

PARAMETER	SYMBOL	TEST CONDITION	V <sub>CC</sub> (V)	Typ.	UNIT
Quiet Output Maximum Dynamic V <sub>OL</sub>	V <sub>OLP</sub>	V <sub>IH</sub> = 1.8 V, V <sub>IL</sub> = 0 V (Note 12)	1.8	0.15	V
		V <sub>IH</sub> = 2.5 V, V <sub>IL</sub> = 0 V (Note 12)	2.5	0.25	
		V <sub>IH</sub> = 3.3 V, V <sub>IL</sub> = 0 V (Note 12)	3.3	0.35	
Quiet Output Minimum Dynamic V <sub>OL</sub>	V <sub>OLV</sub>	V <sub>IH</sub> = 1.8 V, V <sub>IL</sub> = 0 V (Note 12)	1.8	-0.15	V
		V <sub>IH</sub> = 2.5 V, V <sub>IL</sub> = 0 V (Note 12)	2.5	-0.25	
		V <sub>IH</sub> = 3.3 V, V <sub>IL</sub> = 0 V (Note 12)	3.3	-0.35	
Quiet Output Minimum Dynamic V <sub>OH</sub>	V <sub>OHV</sub>	V <sub>IH</sub> = 1.8 V, V <sub>IL</sub> = 0 V (Note 12)	1.8	1.55	V
		V <sub>IH</sub> = 2.5 V, V <sub>IL</sub> = 0 V (Note 12)	2.5	2.05	
		V <sub>IH</sub> = 3.3 V, V <sub>IL</sub> = 0 V (Note 12)	3.3	2.65	

(Note 12): Parameter guaranteed by design.

Capacitive characteristics ( $T_a = 25^\circ\text{C}$ )

PARAMETER	SYMBOL	TEST CONDITION	V <sub>CC</sub> (V)	Typ.	UNIT
Input Capacitance	C <sub>IN</sub>		1.8, 2.5, 3.3	6	pF
Output Capacitance	C <sub>OUT</sub>		1.8, 2.5, 3.3	7	pF
Power Dissipation Capacitance	C <sub>PD</sub>	f <sub>IN</sub> = 10 MHz (Note 13)	1.8, 2.5, 3.3	20	pF

(Note 13): C<sub>PD</sub> is defined as the value of the internal equivalent capacitance which is calculated from the operating current consumption without load.

Average operating current can be obtained by the equation :

$$I_{CC(\text{opr.})} = C_{PD} \cdot V_{CC} \cdot f_{IN} + I_{CC} / 8 \text{ (per bit)}$$

**Test Circuit**

Fig.1

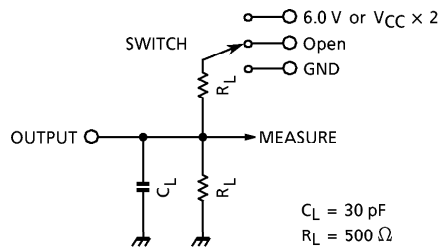

PARAMETER	SWITCH
$t_{pLH}, t_{pHL}$	Open
$t_{pLZ}, t_{pZL}$	6.0 V @ $V_{CC} = 3.3 \pm 0.3$ V $V_{CC} \times 2$ @ $V_{CC} = 2.5 \pm 0.2$ V @ $V_{CC} = 1.8$ V
$t_{pHZ}, t_{pZH}$	GND

**AC Waveform**

Fig.2  $t_{pLH}, t_{pHL}, t_w, t_s, t_h$

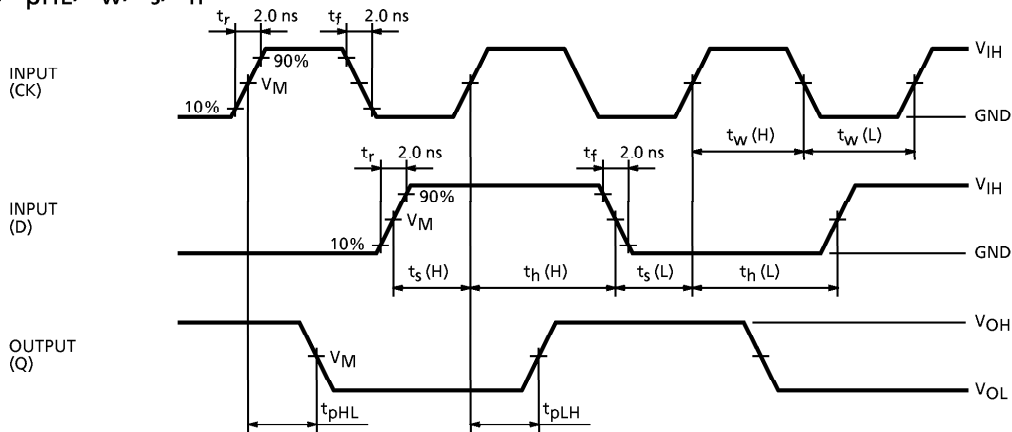
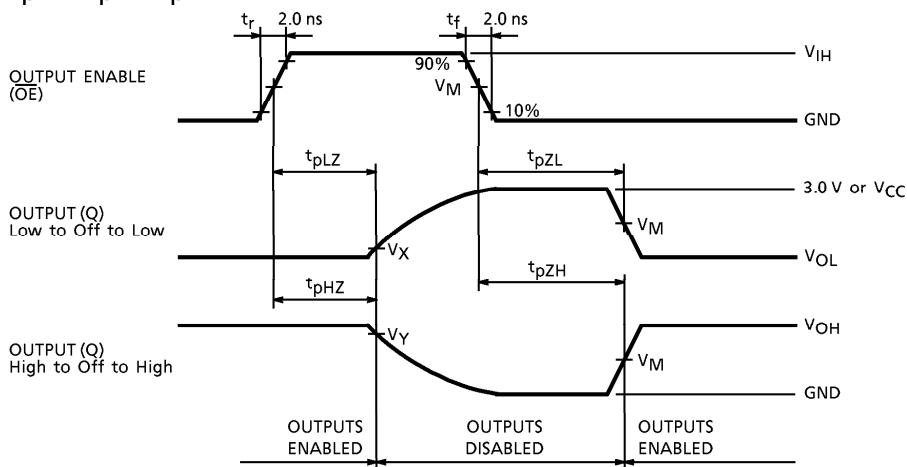

Fig.3  $t_{pLZ}, t_{pHZ}, t_{pZL}, t_{pZH}$



SYMBOL	$V_{CC}$		
	$3.3 \pm 0.3$ V	$2.5 \pm 0.2$ V	1.8 V
$V_{IH}$	2.7 V	$V_{CC}$	$V_{CC}$
$V_M$	1.5 V	$V_{CC} / 2$	$V_{CC} / 2$
$V_X$	$V_{OL} + 0.3$ V	$V_{OL} + 0.15$ V	$V_{OL} + 0.15$ V
$V_Y$	$V_{OH} - 0.3$ V	$V_{OH} - 0.15$ V	$V_{OH} - 0.15$ V



**Outline Drawing**  
VSSOP20-P-0030-0.50

Unit : mm

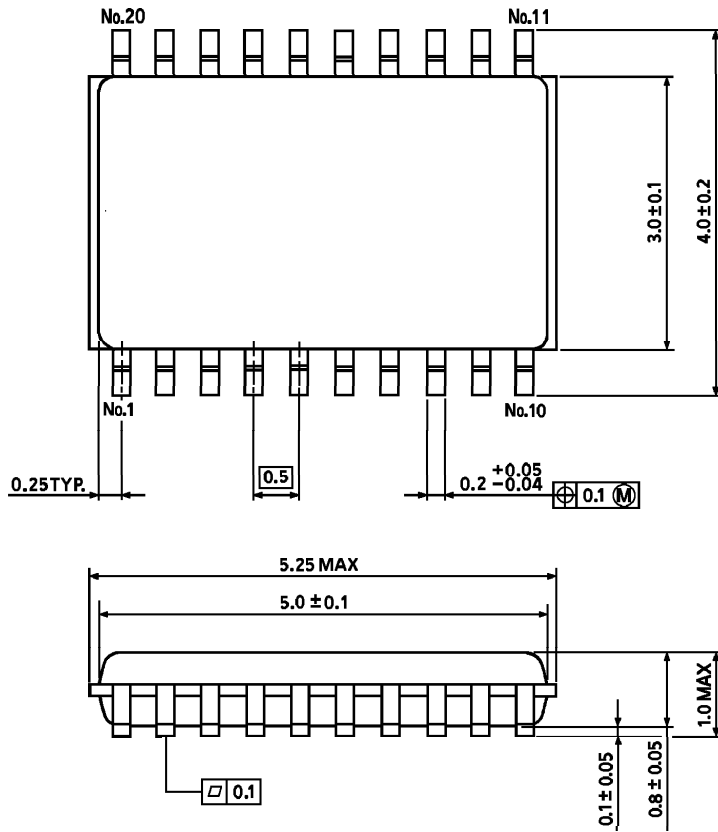

Weight : 0.03 g (typ.)