

TOSHIBA CMOS Digital Integrated Circuit Silicon Monolithic

TC90104AFG

Multi System Video Decoder

The TC90104AFG is a single chip IC that converts analog video signals to digital video signals (ITU-R BT. 601 / ITU-R BT. 656 YCbCr 16, 8bit digital signal).

Additionally, the TC90104AFG has a 3-channel A/D converter as an analog input interface, and has 3-line Y/C separation and multi-system color decoder functionality.

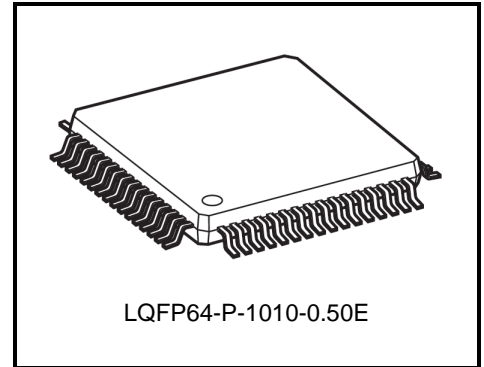

Weight: 0.4 g (typ.)

1. Features

- Input: CVBS, Y/C (S-Video), Y/Cb/Cr (D1, D2)
- Multi-color decoder
- Synchronous playback/ Standard identification
- Y/C separation: 3-line YCS (NTSC/PAL)
BPF processing. (SECAM)
- Picture process Y: V-Enhance, LTI, sharpness, noise cancel, contrast, brightness
C: TOF, ACC, color gain, CTI, noise cancel
- Output: ITU-R BT.601(D1) / ITU-R BT.656(D1) / 16bit(D2) / 8bit serial(D2) .
- I²C-bus control
- Package: LQFP 64 pin (0.50 mm pitch)
- Power supply: 3.3 V, 2.5 V, 1.5 V

2. Block Diagram

To explain the function, there are omitted part for function block and application circuit.

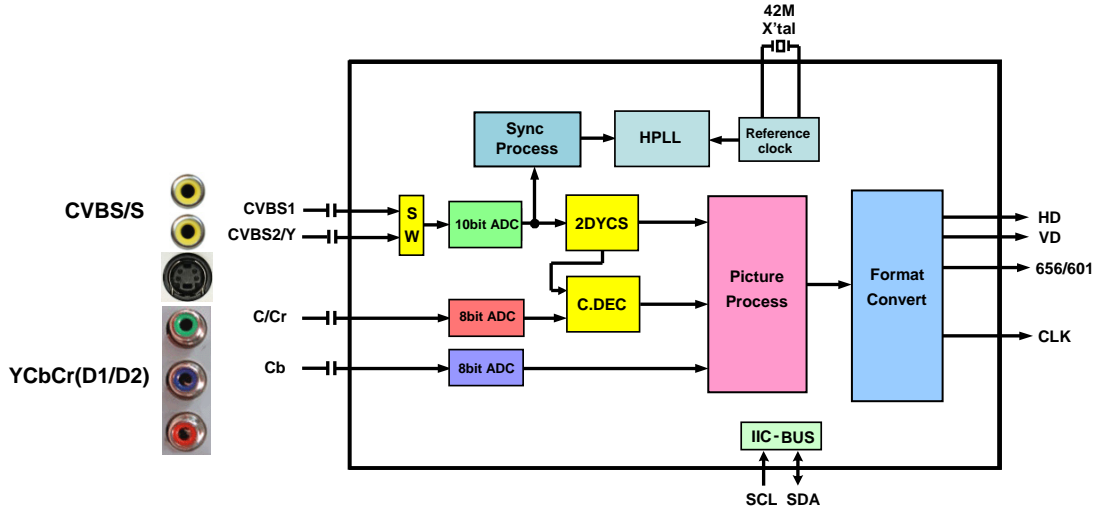

3. Pin Layout

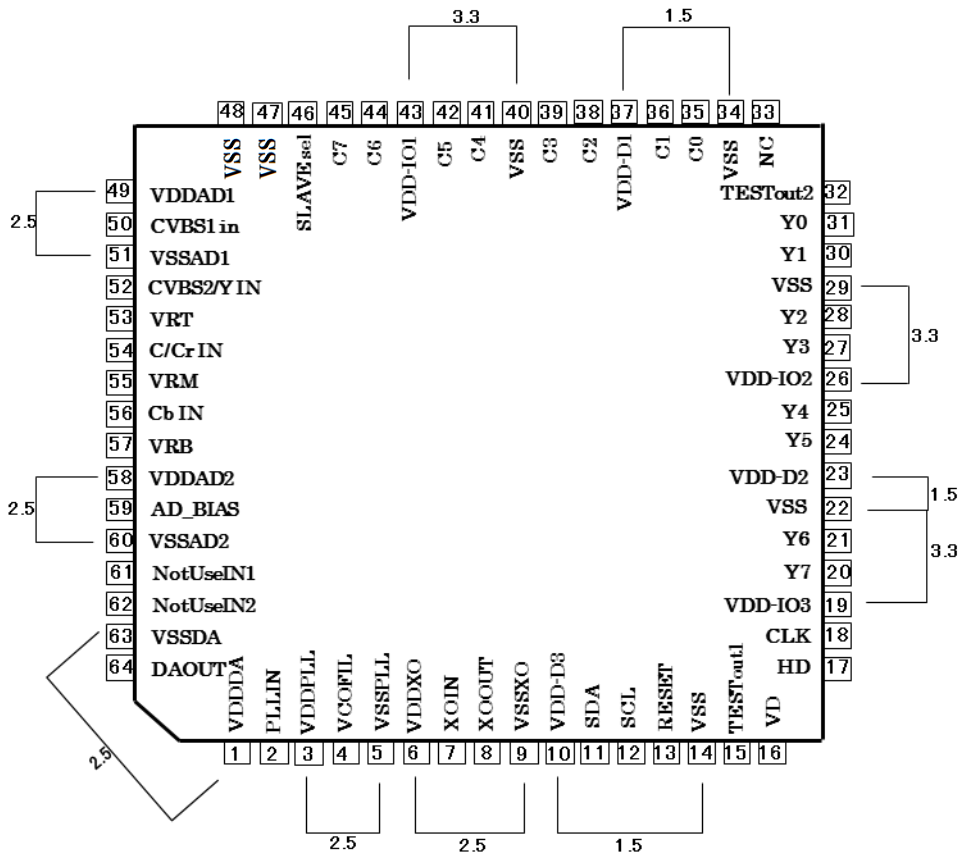

4. Pin Descriptions

Pin No.	Pin Name	Pin Function	Pin type	Standard withstand voltage [V]	Processing at unused time
1	VDDDA	2.5 V power supply for DAC	VDD	2.5	-
2	PLLIN	Input of PLL circuit for clock	IN	2.5	-
3	VDDPLL	2.5 V power supply for PLL circuit	VDD	2.5	-
4	VCOFIL	VCO control bias for PLL circuit	Bias	2.5	-
5	VSSPLL	GND for PLL circuit	VSS	0	-
6	VDDXO	2.5V Power supply for X'tal circuit	VDD	2.5	-
7	XOIN	Input for X'tal circuit	IN	2.5	-
8	XOOUT	Output for X'tal circuit	OUT	2.5	-
9	VSSXO	GND for X'tal circuit	GND	0	-
10	VDD-D3	1.5 V power supply for Logic circuit	VDD	1.5	-
11	SDA	Serial data input/output <I ² C-BUS>	I / O	5	-
12	SCL	Serial clock input <I ² C-BUS>	IN	5	-
13	RESET	System reset	IN	3.3	-
14	VSS	Digital GND	GND	0	-
15	TESTout1	TEST output terminal 1	OUT	3.3	Open
16	VD	VD output	OUT	3.3	Open
17	HD	HD output	OUT	3.3	Open
18	CLK	Clock signal output	OUT	3.3	-
19	VDD-IO3	3.3 V power supply for I/O circuit	VDD	3.3	-
20	Y7	Y7 signal output (MSB) *1	OUT	3.3	-
21	Y6	Y6 signal output *1	OUT	3.3	-
22	VSS	Digital GND	GND	0	-
23	VDD-D2	1.5V power supply for logic circuit	VDD	1.5	-
24	Y5	Y5 signal output *1	OUT	3.3	-
25	Y4	Y4 signal output *1	OUT	3.3	-
26	VDD-IO2	3.3V power supply for I/O circuit	VDD	3.3	-
27	Y3	Y3 signal output *1	OUT	3.3	-
28	Y2	Y2 signal output *1	OUT	3.3	-
29	VSS	Digital GND	GND	0	-
30	Y1	Y1 signal output	OUT	3.3	-
31	Y0	Y0 signal output	OUT	3.3	-
32	TESTout2	TEST output terminal 2	OUT	3.3	Open

*1: It is available for SAV/EAV implantation when input signal is CVBS or YCbCr(D1) and output is ITU-R BT.656 format. It needs to use HD/VD output mode because it is not available for SAV/EAV implantation when output is D2 signal (54MHz 8bit).

Pin No.	Pin Name	Pin Function	Pin type	Standard withstand voltage [V]	Processing at unused time
33	NC	Non-connection	OUT	3.3	-
34	VSS	Digital GND	GND	0	-
35	C0	C0 signal output (LSB) *2	OUT	3.3	-
36	C1	C1 signal output *2	OUT	3.3	-
37	VDD-D1	1.5 V power supply for logic circuit	VDD	1.5	-
38	C2	C2 signal output *2	OUT	3.3	-
39	C3	C3 signal output *2	OUT	3.3	-
40	VSS	Digital GND	GND	0	-
41	C4	C4 signal output *2	OUT	3.3	-
42	C5	C5 signal output *2	OUT	3.3	-
43	VDD-IO1	3.3 V power supply for I/O circuit	VDD	3.3	-
44	C6	C6 signal output *2	OUT	3.3	-
45	C7	C7 signal output *2	OUT	3.3	-
46	SLAVE sel	I ² C-BUS slave-address selector	IN	3.3	-
47	VSS	Digital GND	GND	0	-
48	VSS	Digital GND	GND	0	-
49	VDDAD1	2.5 V power supply for ADC circuit	VDD	2.5	-
50	CVBS1 in	Composite video signal input	IN	2.5	GND via 0.1μF
51	VSSAD1	GND for ADC circuit	GND	0	-
52	CVBS2/Y IN	Composite video / Y signal input	IN	2.5	GND via 0.1μF
53	VRT	Reference top voltage for ADC	Bias	2.5	-
54	C/Cr IN	C / Cr video signal input	IN	2.5	GND via 0.1μF
55	VRM	Reference middle voltage for ADC	Bias	2.5	-
56	Cb IN	Cb video signal input	IN	2.5	GND via 0.1μF
57	VRB	Reference bottom voltage for ADC	Bias	2.5	-
58	VDDAD2	2.5 V power supply for ADC circuit	VDD	2.5	-
59	AD_BIAS	Reference voltage for ADC	Bias	2.5	-
60	VSSAD2	GND for ADC circuit	GND	0	-
61	NotUseIN1	To GND via 10kΩ resistor	IN	3.3	GND via 10kΩ resistor
62	NotUseIN2	To GND via 10kΩ resistor	IN	3.3	GND via 10kΩ resistor
63	VSSDA	GND for DAC circuit for clock	GND	0	-
64	DAOUT	Output of DAC circuit for clock	OUT	2.5	-

*2 When 8bit output mode, output of C7 to C0 terminal are fixed to Low. Therefore these must be open.

5. Function

5.1 Overview

- Analog input interface for Composite video signal, Y/C signal (S signal), Component signal (D1/D2)
- Multi system 3 line comb filter (2DYCS)
- Multi system color decoder and sync generation processing
- Color system detection (selectable auto detection or manual setting)
- Picture quality processing function
- Digital output interface for ITU-R BT. 601/656

5.2 Input signal

5.2.1 Input signal list

Input signal format		Frequency			Effective pixels		Total pixels		
		fH [kHz]	fV [Hz]	fs [MHz]	Horizontal	Vertical	Horizontal	Vertical	
CVBS	NTSC	15.75/15.734	60/59.94	27	720	240	858	262.5	
	PAL/SECAM	15.625	50	27	720	288	864	312.5	
Y/C	NTSC	15.75/15.734	60/59.94	27	720	240	858	262.5	
	PAL	15.625	50	27	720	288	864	312.5	
YCbCr	D1	480i	15.75/15.734	60	27	720	240	858	262.5
		576i	15.625	50	27	720	288	864	312.5
	D2	480p	31.5/31.469	60	27	720	480	858	525
		576p	31.25	50	27	720	576	864	625

5.2.2 Input signal

The TC90104AFG is equipped with 3-ch ADC for Composite video signal, Y/C signal and YCbCr signal input.

The input-dynamic-range for ADC is designed in AVDD x 0.4 [V] with the normal input dynamic range being 1 Vp-p (AVDD = 2.5 V). Be sure to use 0.7 Vp-p (1 Vp-p x 0.7) with 140IRE input when using NTSC as the recommended reference input amplitude.

5.2.3 Table of Input – Output signal

Input signal		Processing			Output signal						
Input format		f H [kHz]	Sampling clock [MHz]	Internal Format	Output clock [MHz]	RGB	601 656	HD	VD	ENB	
CVBS	NTSC	15.75/15.734	27	4:2:2	13.5 / 27	-	○	○	○	-	
	PAL	15.625	27	4:2:2	13.5 / 27	-	○	○	○	-	
Y/C	NTSC	15.75/15.734	27	4:2:2	13.5 / 27	-	○	○	○	-	
	PAL	15.625	27	4:2:2	13.5 / 27	-	○	○	○	-	
YCbCr	D1	480i	15.75/15.734	27	4:2:2	13.5 / 27	-	○	○	○	-
		576i	15.625	27	4:2:2	13.5 / 27	-	○	○	○	-
	D2	480p	31.5/31.469	27	4:2:2	27	-	○	○	○	-
		576p	31.25	27	4:2:2	27	-	○	○	○	-

5.2.4 Typical input level of analog input signal

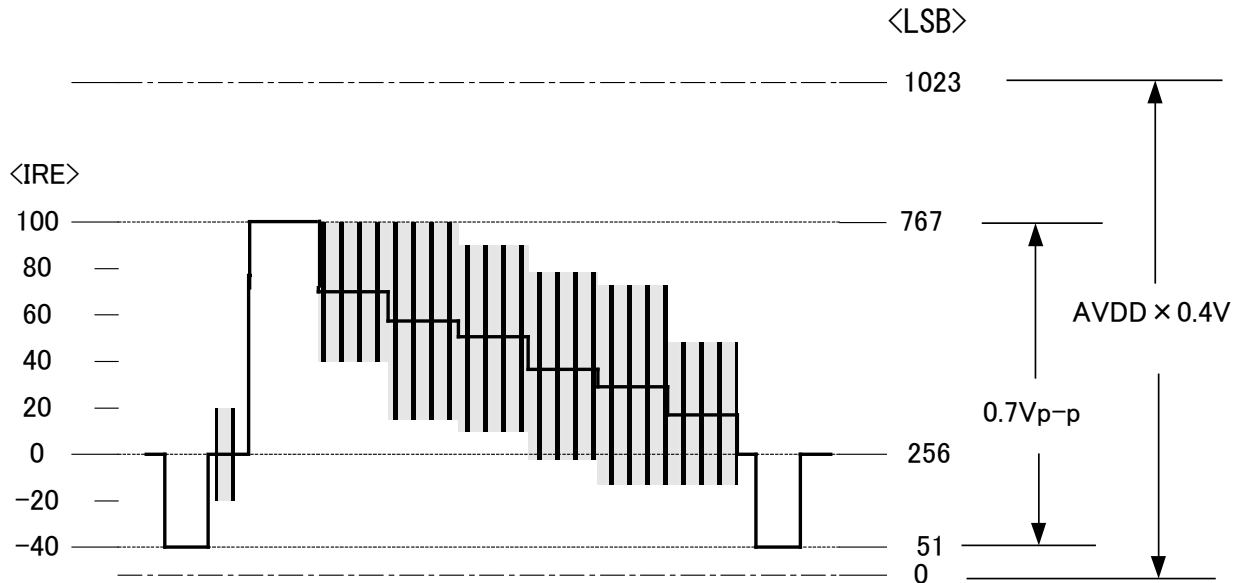

Fig.1 Reference input level to CVBS1(Composite Video) and CVBS2/Y/G(S-Video Y, Component Y) when 100% White (i.e., composite video input)

CVBS, Y, Component-Y signal need to input 0.7 Vpp when 140IRE, and also C signal (S-signal) need to input 0.2 Vpp when 40IRE. (VDD = 2.5 V, 140IRE = 0.7 Vpp at NTSC)
 When use Component-CbCr , CbCr-level is 0.7 Vpp for 100%.
 An above waveform is color bar signal of 75%

Input terminal	Input level = Vp-p *1	Output : LSB *2	Notes
CVBS	0.7 Vp-p (500 mVp-p)	16-235 (for 8bit)	Output at 656/601 format
Y	0.7 Vp-p (500 mVp-p)	16-235 (for 8bit)	Output at 656/601 format
C	0.2 Vp-p (Burst signal)	31-225 (for 8bit)	Output at 656/601 format
Cb	0.7 Vp-p	31-225 (for 8bit)	Output at 656/601 format
Cr	0.7 Vp-p	31-225 (for 8bit)	Output at 656/601 format

*1 About input level,
 It has indicate the case of NTSC.
 CVBS and Y input level will be 140IRE at the White of 100%.
 Please adjust to 0.7 V this 100%.
 Values in the () is the level of from the pedestal to white 100%.

Input level of C(= chroma signal) has indicate the burst level at the time of NTSC.
 Input level of CbCr has indicate the level of color-100% at the time of NTSC.

*2 About output level,
 It has indicate the case of NTSC.
 CVBS and Y output level is white 100% output level at the time of NTSC.
 Values in the () is the output level of from the pedestal to white 100%.

Output level of C(chroma signal) indicate the CbCr level at the time of color-100%.
 Output level of CbCr indicate the level of color-100% at the time of NTSC.

Notes: The above output level is influenced by the picture quality adjustment of contrast, gain, ACC and others.
 It does not indicate the maximum level.

Fig.2 Reference input level to C/Cr/R (S-Video C)

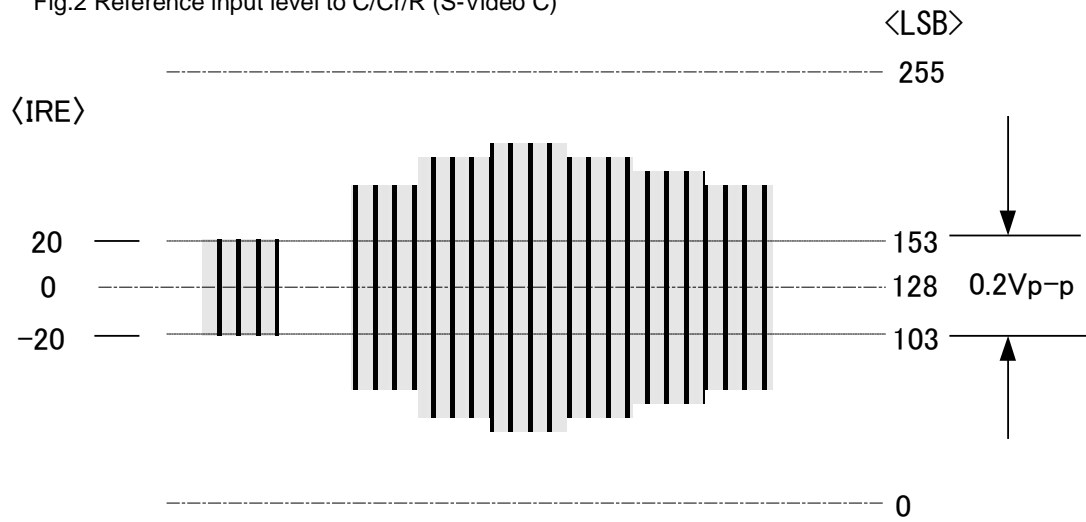
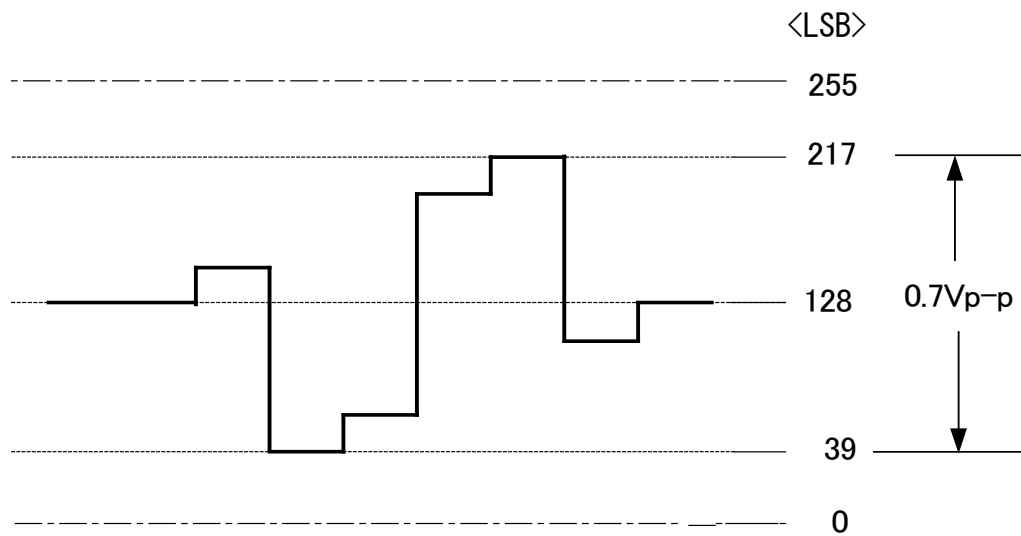

Fig.3 Typical input level to C/Cr./R (Component Cr) and Cb/B (Component Cb)



5.2.5 Output format

The output format (ITU-R BT.656/601) is below.

Output signal	Bit	Data rate	Description
Y [0-7]	8	13.5 MHz/27 MHz (ITU-R BT.601/656)	Y / YCbCr (ITU-R BT.601/656)
C [0-7]	8	6.75 MHz	Cb / Cr (CLK: 13.5 MHz)
CLK	1	13.5 MHz/27 MHz	864fH/1728fH: 625 line system 858fH/1716fH: 525 line system Polarity: negative (Initial setting)
HD	1	f H	Recovered horizontal sync signal
VD	1	f V	Recovered vertical sync signal

HD / VD pulse width in "Sync-through" mode

	525i system	625i system
HD pulse width	4.74 μ s (128 cycle @ 27 MHz clock)	
VD pulse width	3.0 H	2.5 H or 3.0 H

***Notes**

The HD pulse width used in ITU-R BT.656-compliant mode is the same as the zone defined from EAV to SAV.
 If a non-standard signal is input during ITU-R BT.656-compliant mode, then the values may not necessarily be the values shown in the above chart.
 The VD pulse is synchronized using the HD standard. As a result, if the H cycle jitters, then the VD width will also jitter. Also, in Through mode, the phase with the HD will be off 0.5 H in ODD/EVEN.

5.2.5.1. 525i/60Hz Input mode

(1st field : ODD)

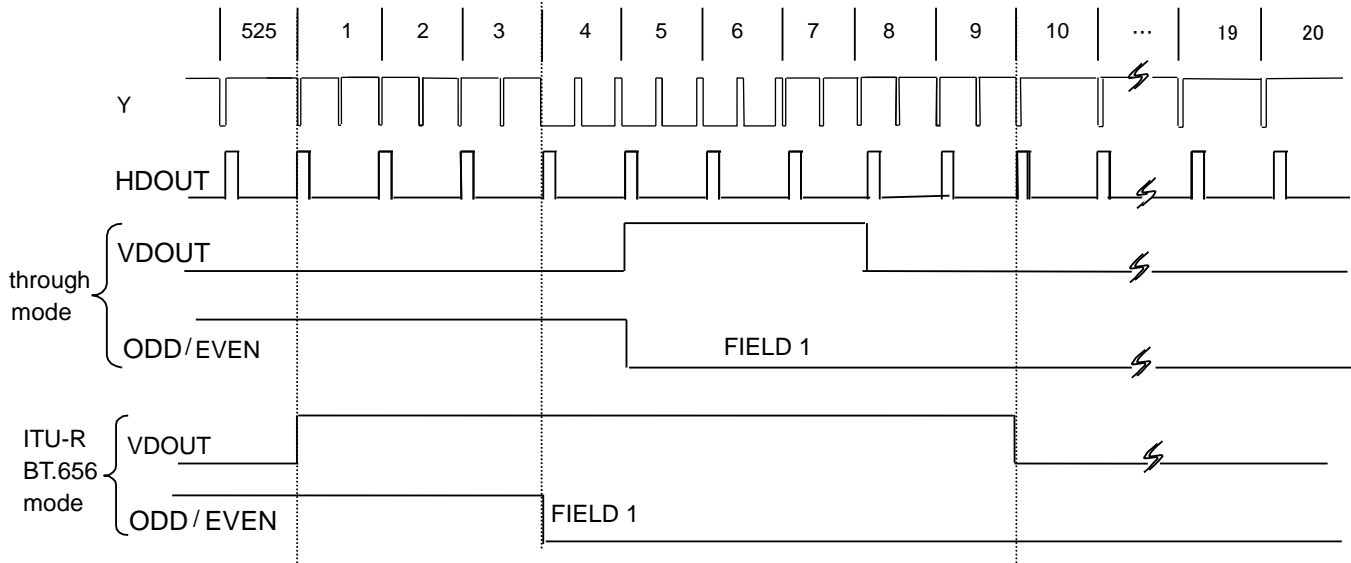

Change of Through mode and ITU-R BT.656 mode
 ITU-R BT.656: Field1; Line 4 EAV
 Field Blanking ; Start → Line 1 EAV, Finish → Line 10 EAV

(2nd field :EVEN)

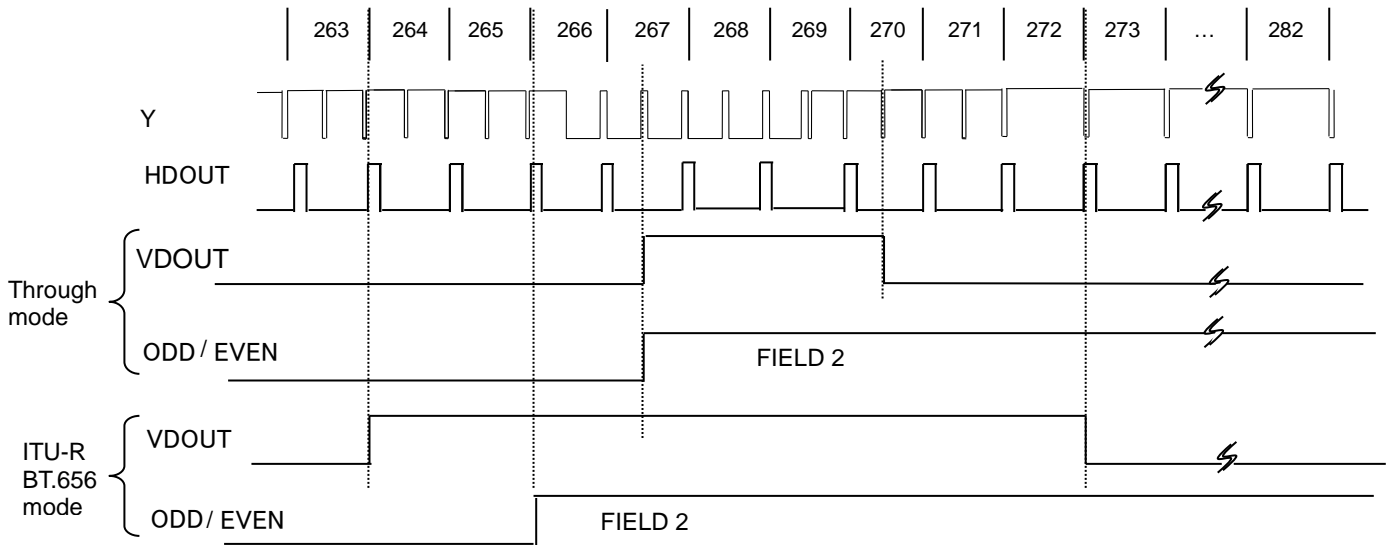

Change of Through mode and ITU-R BT.656 mode
 ITU-R BT.656: Field 2; Line 266 EAV
 Field Blanking ; Start → Line 264 EAV, Finish → Line 273 EAV

5.2.5.2. HD and VD timing when 480p/60Hz input

525p/59.94(fH = 31.469 kHz)@54 MHz_8bit output

H out (H:31.469kHz=1716ck_Effective horizontal period:26.630μs=1438ck)

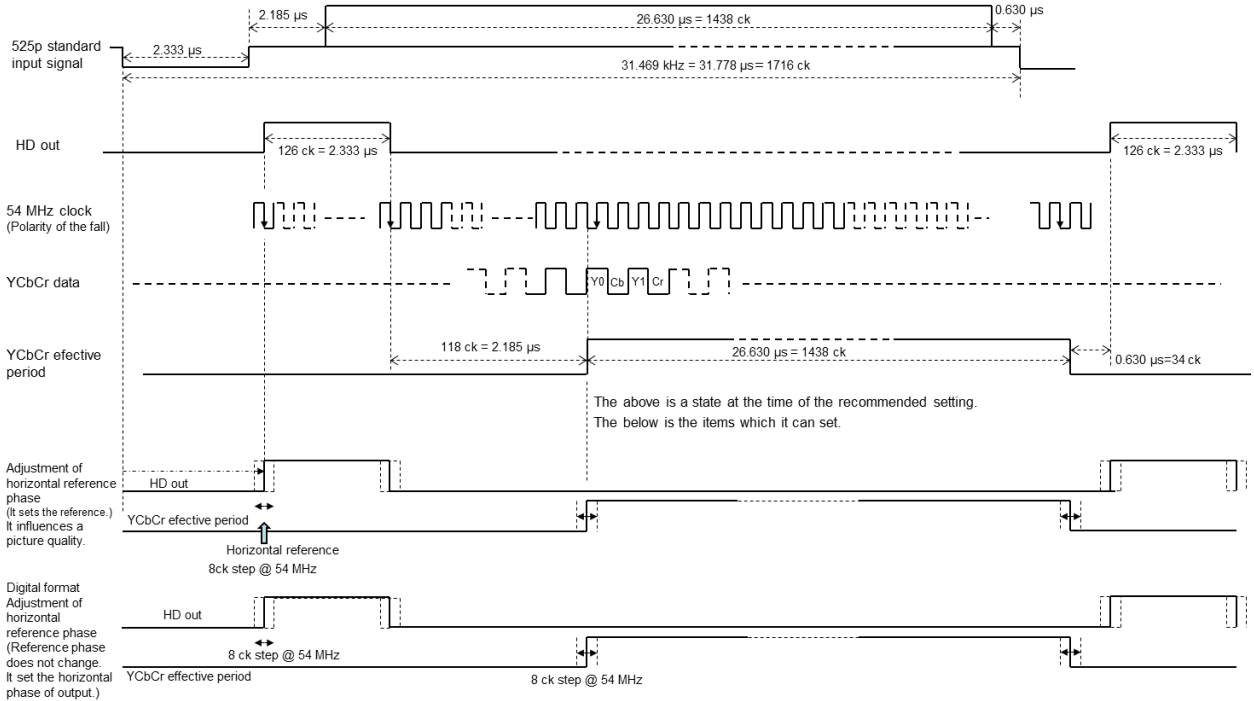

V out (Vertical:525 line_Effective vertical :480 line)

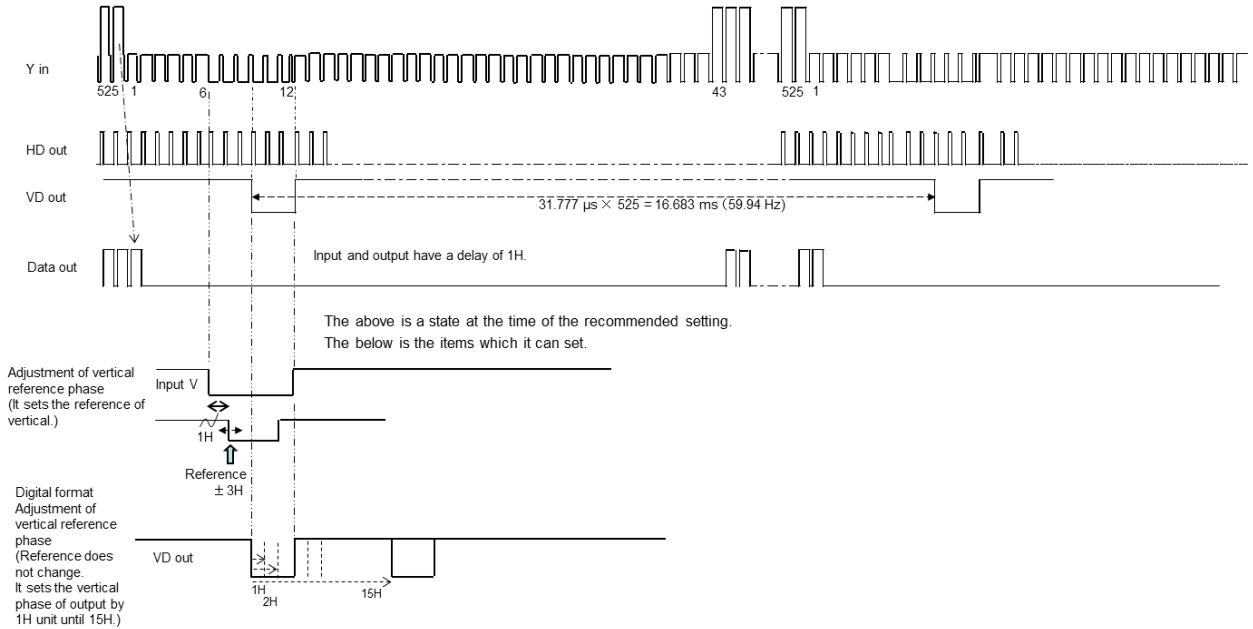

6. Absolute Maximum rating

The maximum ratings are rated values which must not be exceeded during operation, even for an instant. Exceeding the maximum rating may result in destruction, degradation or other damage to the IC and other components. When designing applications for this IC, be sure that none of the maximum rating values will ever be exceeded.

Characteristics	Symbol	Rating	Unit
Power voltage1 (1.5 V system)	VDD1	-0.3 to VSS + 2.0	V
Power voltage2 (2.5 V system)	VDD2	-0.3 to VSS + 3.5	V
Power voltage3 (3.3 V system)	VDD3	-0.3 to VSS + 3.9	V
Input voltage (1.5 V system)	VIN1	-0.3 to VDD1 + 0.3	V
Input voltage (2.5 V system)	VIN2	-0.3 to VDD2 + 0.3	V
Input voltage (3.3 V system)	VIN3	-0.3 to VDD3 + 0.3	V
Input voltage (3.3 V system, 5 V withstand voltage)	VIN4 (Notes1)	-0.3 to VSS + 5.5	V
Potential difference between power pins (between 1.5 V system power pins)	Δ V _{DG1} (Notes2)	0.3	V
Potential difference between power pins (between 2.5 V system power pins)	Δ V _{DG2} (Notes2)	0.3	V
Potential difference between power pins (between 3.3 V system power pins)	Δ V _{DG3} (Notes2)	0.3	V
Power dissipation	PD (Notes3)	2190	mW
Storage temperature	T _{stg}	-40 to 125	°C

Note1: The withstand voltage for pins (SDA, SCL) is 5 V.

Note2: For each of 1.5 V and 2.5 V and 3.3 V, system power supply terminal is made into the same voltage. The maximum potential difference should not exceed rating for all power supply terminals then. In addition, potential difference between all V_{SS} terminal must be under 0.01 V in this status.

Note3: If you intended to use a temperature higher than Ta = 25°C, reduce by 21.9 mW per one degree (°C) increase.

7. Operating ranges

The TC90104AFG is not guaranteed to function correctly if it is used outside its specified power voltage range (1.5 V system power: 1.40 V to 1.60 V, 2.5 V system power: 2.3 V to 2.7 V, 3.3 V system power: 3.0 V to 3.6V). Please use within the specified operating conditions.

If you temporarily leave and then return to the specified operating conditions, this IC's conditions will change, and so it is necessary to reset the IC's power to continue using it correctly within the specified operating conditions.

Characteristics	Corresponding terminal	Symbol	Min	Typ.	Max	Unit
Power voltage of digital block	10, 23, 37	VDD-D	1.4	1.5	1.6	V
Power voltage of I/O block	19, 26, 43	VDD-IO	3.0	3.3	3.6	V
Power voltage of XO block	6	VDDXO	2.3	2.5	2.7	V
Power voltage of PLL block	3	VDDPLL	2.3	2.5	2.7	V
Power voltage of analog block	1, 49, 58	VDDDA, VDDAD	2.3	2.5	2.7	V
Operating temperature		T _{opr}	-40	—	85	°C

8. Electrical characteristic

8.1 DC characteristic

(Ta = 25°C, 1.5 V system = 1.50 ± 0.1 V, 2.5 V system = 2.50 ± 0.2 V, 3.3 V system = 3.30 ± 0.3 V)

Characteristic	Terminal NO.	Symbol	Min	Typ.	Max	Unit	Note
Power supply current	10, 23, 37	IDD1 (1.5 V system)	—	46	70	mA	Depend on load at 3.3 V system.
	1, 3, 6, 49, 58	IDD2 (2.5 V system)	—	82	125	mA	
	19, 26, 43	IDD3 (3.3 V system)	—	10	—	mA	
Input voltage	13, 46, 47, 48, 61, 62	VIH	VDD3x0.8	—	VDD3	V	I/O input terminal of 3.3 V system
	11, 12						I/O input terminal of 5.0 V tolerant system
	13, 46, 47, 48, 61, 62	VIL	VSS	—	VDD3x0.2	V	I/O input terminal of 3.3 V system
	11, 12						I/O input terminal of 5.0 V tolerant system
Input current	13, 46, 47, 48, 61, 62	IIH	-10	—	10	μA	I/O input terminal of 3.3 V system
	11, 12						I/O input terminal of 5.0 V tolerant system
	13, 46, 47, 48, 61, 62	IIL	-10	—	10	μA	I/O input terminal of 3.3 V system
	11, 12						I/O input terminal of 5.0 V tolerant system
Output voltage	15, 16, 17, 18, 20, 21, 24, 25, 27, 28, 30, 31, 32, 33, 35, 36, 38, 39, 41, 42, 44, 45	VOH	VDD3-0.6	—	VDD3	V	I/O output terminal of 3.3 V system when load current: -4 mA
		VOL	VSS	—	0.4	V	I/O output terminal of 3.3 V system when load current: +4 mA

9. Package

LQFP64-P-1010-0.50E

Unit: mm

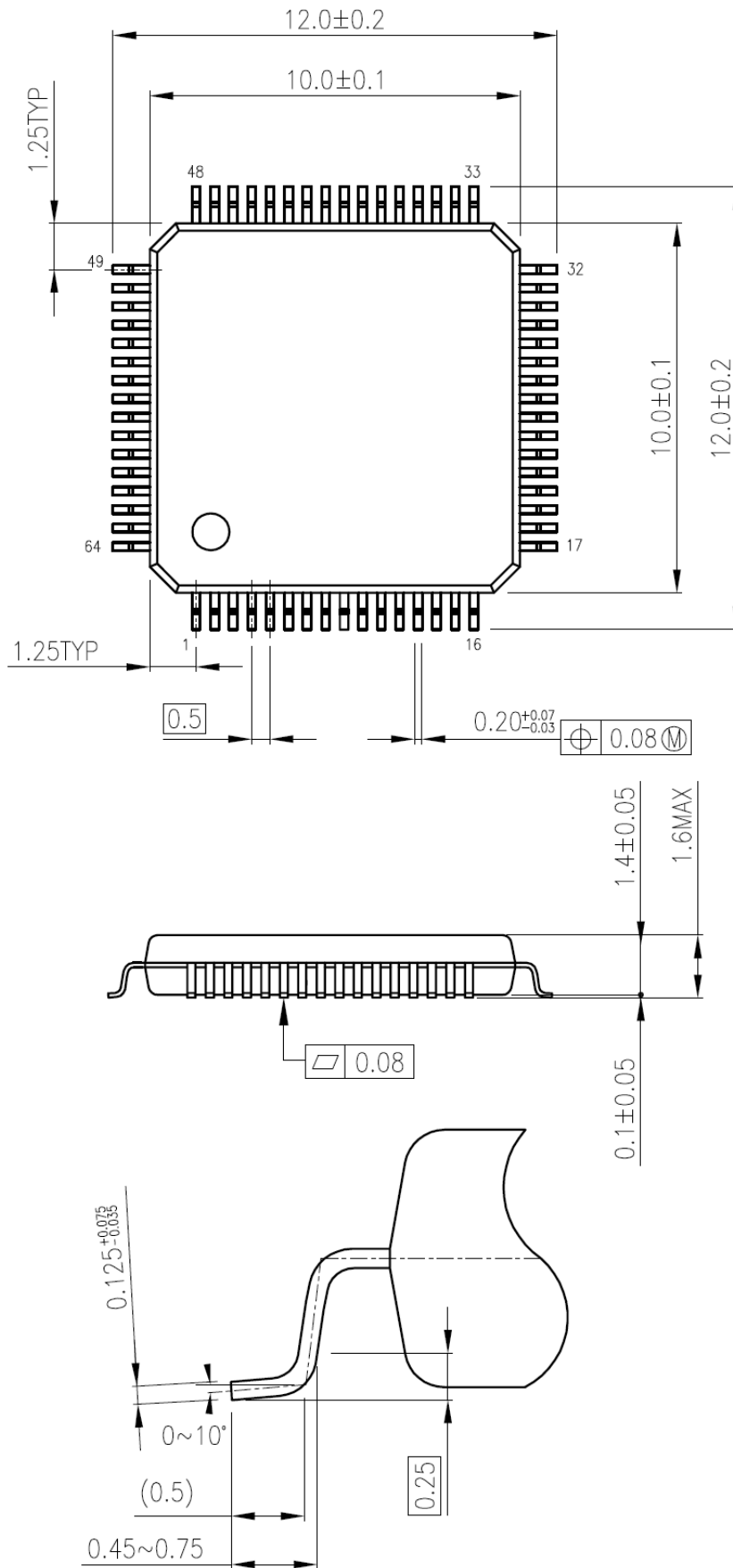

Weight: 0.4 g (Typ.)

RESTRICTIONS ON PRODUCT USE

- Toshiba Corporation, and its subsidiaries and affiliates (collectively "TOSHIBA"), reserve the right to make changes to the information in this document, and related hardware, software and systems (collectively "Product") without notice.
- This document and any information herein may not be reproduced without prior written permission from TOSHIBA. Even with TOSHIBA's written permission, reproduction is permissible only if reproduction is without alteration/omission.
- Though TOSHIBA works continually to improve Product's quality and reliability, Product can malfunction or fail. Customers are responsible for complying with safety standards and for providing adequate designs and safeguards for their hardware, software and systems which minimize risk and avoid situations in which a malfunction or failure of Product could cause loss of human life, bodily injury or damage to property, including data loss or corruption. Before customers use the Product, create designs including the Product, or incorporate the Product into their own applications, customers must also refer to and comply with (a) the latest versions of all relevant TOSHIBA information, including without limitation, this document, the specifications, the data sheets and application notes for Product and the precautions and conditions set forth in the "TOSHIBA Semiconductor Reliability Handbook" and (b) the instructions for the application with which the Product will be used with or for. Customers are solely responsible for all aspects of their own product design or applications, including but not limited to (a) determining the appropriateness of the use of this Product in such design or applications; (b) evaluating and determining the applicability of any information contained in this document, or in charts, diagrams, programs, algorithms, sample application circuits, or any other referenced documents; and (c) validating all operating parameters for such designs and applications. **TOSHIBA ASSUMES NO LIABILITY FOR CUSTOMERS' PRODUCT DESIGN OR APPLICATIONS.**
- **PRODUCT IS NEITHER INTENDED NOR WARRANTED FOR USE IN EQUIPMENTS OR SYSTEMS THAT REQUIRE EXTRAORDINARILY HIGH LEVELS OF QUALITY AND/OR RELIABILITY, AND/OR A MALFUNCTION OR FAILURE OF WHICH MAY CAUSE LOSS OF HUMAN LIFE, BODILY INJURY, SERIOUS PROPERTY DAMAGE AND/OR SERIOUS PUBLIC IMPACT ("UNINTENDED USE").** Except for specific applications as expressly stated in this document, Unintended Use includes, without limitation, equipment used in nuclear facilities, equipment used in the aerospace industry, medical equipment, equipment used for automobiles, trains, ships and other transportation, traffic signaling equipment, equipment used to control combustions or explosions, safety devices, elevators and escalators, devices related to electric power, and equipment used in finance-related fields. **IF YOU USE PRODUCT FOR UNINTENDED USE, TOSHIBA ASSUMES NO LIABILITY FOR PRODUCT.** For details, please contact your TOSHIBA sales representative.
- Do not disassemble, analyze, reverse-engineer, alter, modify, translate or copy Product, whether in whole or in part.
- Product shall not be used for or incorporated into any products or systems whose manufacture, use, or sale is prohibited under any applicable laws or regulations.
- The information contained herein is presented only as guidance for Product use. No responsibility is assumed by TOSHIBA for any infringement of patents or any other intellectual property rights of third parties that may result from the use of Product. No license to any intellectual property right is granted by this document, whether express or implied, by estoppel or otherwise.
- **ABSENT A WRITTEN SIGNED AGREEMENT, EXCEPT AS PROVIDED IN THE RELEVANT TERMS AND CONDITIONS OF SALE FOR PRODUCT, AND TO THE MAXIMUM EXTENT ALLOWABLE BY LAW, TOSHIBA (1) ASSUMES NO LIABILITY WHATSOEVER, INCLUDING WITHOUT LIMITATION, INDIRECT, CONSEQUENTIAL, SPECIAL, OR INCIDENTAL DAMAGES OR LOSS, INCLUDING WITHOUT LIMITATION, LOSS OF PROFITS, LOSS OF OPPORTUNITIES, BUSINESS INTERRUPTION AND LOSS OF DATA, AND (2) DISCLAIMS ANY AND ALL EXPRESS OR IMPLIED WARRANTIES AND CONDITIONS RELATED TO SALE, USE OF PRODUCT, OR INFORMATION, INCLUDING WARRANTIES OR CONDITIONS OF MERCHANTABILITY, FITNESS FOR A PARTICULAR PURPOSE, ACCURACY OF INFORMATION, OR NONINFRINGEMENT.**
- Do not use or otherwise make available Product or related software or technology for any military purposes, including without limitation, for the design, development, use, stockpiling or manufacturing of nuclear, chemical, or biological weapons or missile technology products (mass destruction weapons). Product and related software and technology may be controlled under the applicable export laws and regulations including, without limitation, the Japanese Foreign Exchange and Foreign Trade Law and the U.S. Export Administration Regulations. Export and re-export of Product or related software or technology are strictly prohibited except in compliance with all applicable export laws and regulations.
- Please contact your TOSHIBA sales representative for details as to environmental matters such as the RoHS compatibility of Product. Please use Product in compliance with all applicable laws and regulations that regulate the inclusion or use of controlled substances, including without limitation, the EU RoHS Directive. **TOSHIBA ASSUMES NO LIABILITY FOR DAMAGES OR LOSSES OCCURRING AS A RESULT OF NONCOMPLIANCE WITH APPLICABLE LAWS AND REGULATIONS.**