

TC9090AN, TC9090AF

MULTICOLOR SYSTEM VERSION

3-LINE DIGITAL Y / C SEPARATION IC

The TC9090AN and TC9090AF separate luminance (Y) and chrominance (C) signals from a multicolor system composite video signal. It employs the Toshiba logical comb filter to realize high performance Y/C separation at low cost.

FEATURES

- TV systems : NTSC, PAL, N-PAL, M-PAL, 4.43NTSC
- PLL 4× multiplication circuit
- Sync tip clamping circuit
- Internal 8bit A/D converter
- Internal 8bit D/A converters (2ch)
- 4H line memories
- Dynamic comb filter
- 1-line dot interference correction circuit
- Vertical edge enhancement circuit
- Color killer mode (Y/C separation OFF)
- Chroma output band width selectable
- I²C bus control
- SDIP28/SOP28 package
- 5V single power supply

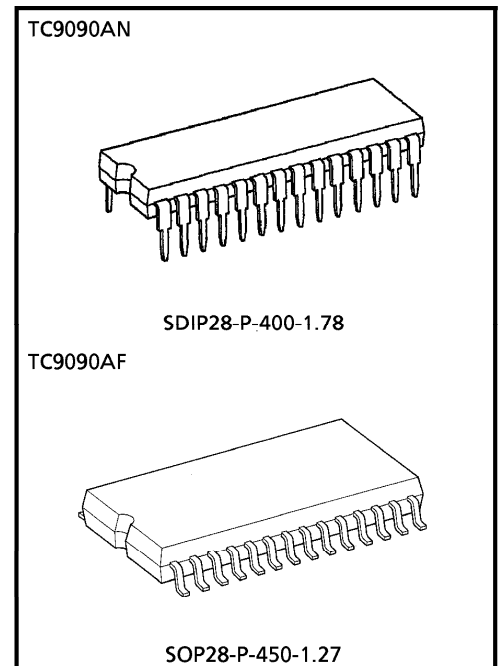

Weight
 SDIP28-P-400-1.78 : 1.7g (Typ.)
 SOP28-P-450-1.27 : 0.8g (Typ.)

BLOCK DIAGRAM

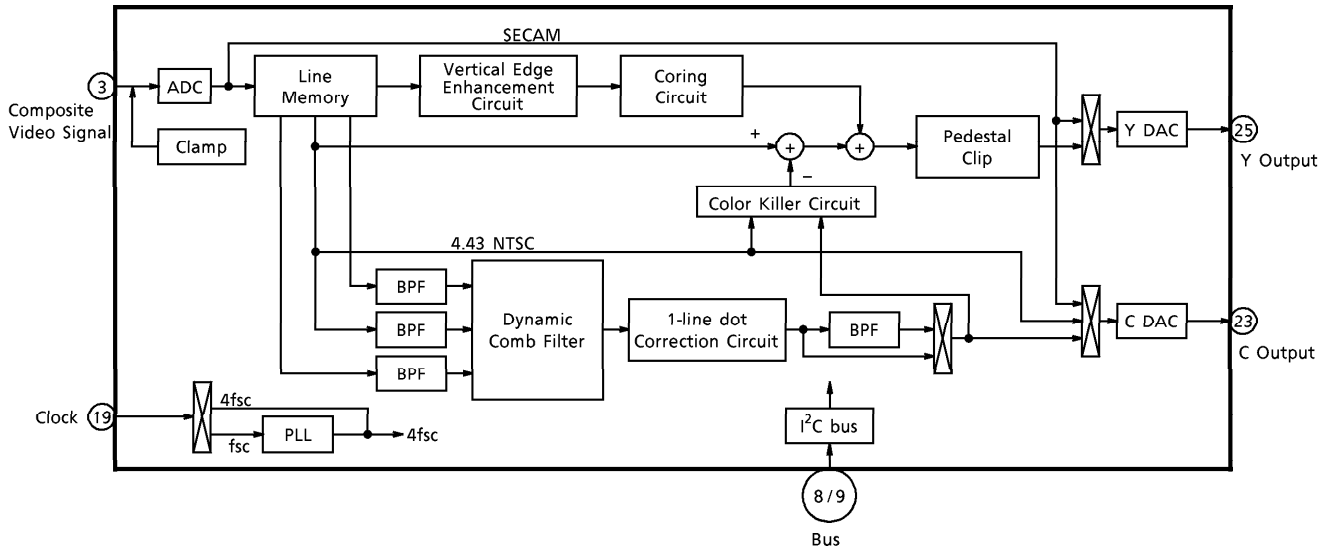

TERMINAL CONNECTION DIAGRAM

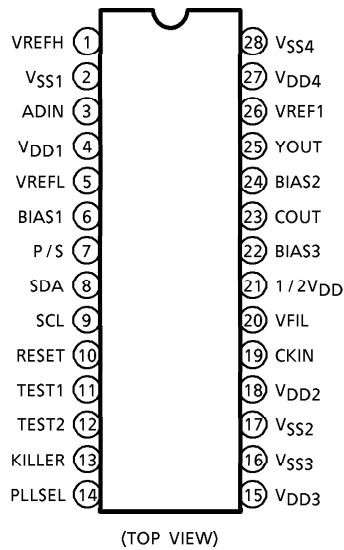

TERMINAL FUNCTION

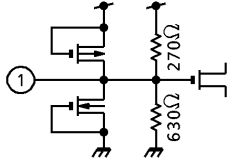
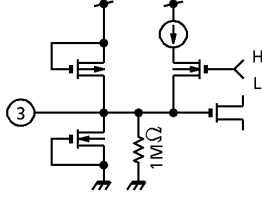
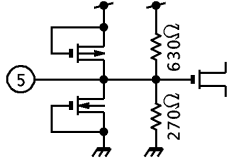
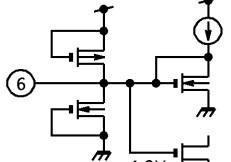
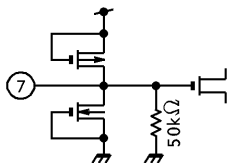
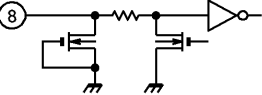
PIN No.	PIN NAME	FUNCTION		I/O	INTERFACE CIRCUIT
1	VREFH	ADC bias higher limit reference voltage. This defaults internally to approximately 3.5V, so this pin should normally be connected to ground through a 0.01 μ F capacitor.		I	
2	VSS1	ADC ground.		—	—
3	ADIN	Composite video signal input.		I	
4	VDD1	ADC Power supply (+ 5V).		—	—
5	VREFL	ADC bias lower limit reference voltage. This defaults internally to approximately 1.5V, so this pin should normally be connected to ground through a 0.01 μ F capacitor.		—	
6	BIAS1	ADC bias voltage. This defaults internally to approximately 1.3V, so this pin should normally be connected to ground through a 0.01 μ F capacitor.		—	
7	P/S	Control mode select. L : I ² C bus control H : Pin control		I	
8	SDA (TVSW1)	I ² C bus	Data input, acknowledge output.	I/O	
		Pin	TV system select.	I	

PIN No.	PIN NAME	FUNCTION		I/O	INTERFACE CIRCUIT
9	SCL (TVSW2)	I ² C bus	Clock.	I	
		Pin	TV system select.	I	
10	RESET (TVSW3)	I ² C bus	Data reset.	I	
		Pin	TV system select.	I	
11	TEST1 (VENH0)	I ² C bus	Test terminal. Normally connected to digital ground.	—	
		Pin	TV system select.	I	
12	TEST2 (VENH1)	I ² C bus	Test terminal. Normally connected to digital ground.	—	
		Pin	Vertical edge enhancement level select.	I	
13	KILLER	Color killer mode select. L : Color H : Black and white		I	
14	PLLSEL	PLL circuit select. (Switches input clock frequency.) L : PLL ON, fsc input H : PLL OFF, 4fsc input		I	
15	VDD3	Power supply for digital components (+5V).		—	—
16	VSS3	Ground for digital components.		—	—
17	VSS2	PLL ground.		—	—
18	VDD2	PLL power supply (+5V).		—	—
19	CKIN	Clock input. After applying a capacitor for DC cut, input a color-burst-synchronized fsc/4fsc clock signal to this pin.		I	
20	VFIL	Connect a VCO filter to this pin.		—	

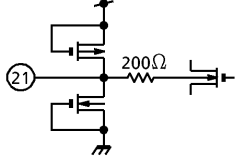
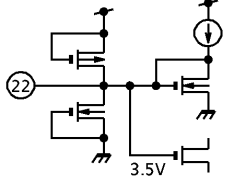
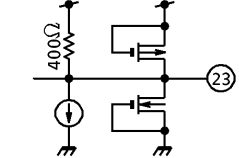
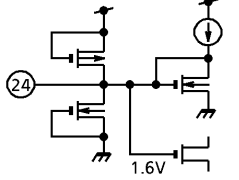
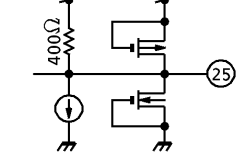
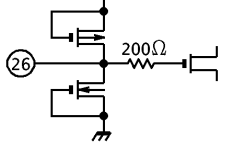
PIN No.	PIN NAME	FUNCTION	I/O	INTERFACE CIRCUIT
21	1/2V _{DD}	Bias for line memory. This pin requires 2.5V external bias.	I	
22	BIAS3	Bias for DAC. This defaults internally to 3.5V, so this pin should normally be connected to ground through a 0.01μF capacitor.	—	
23	COUT	Chrominance signal output.	O	
24	BIAS2	Bias for DAC. This defaults internally to 1.6V, so this pin should normally be connected to ground through a 0.01μF capacitor.	I	
25	YOUT	Luminance signal output.	O	
26	VREF1	DAC bias lower-limit reference voltage for. This pin requires 3.0V external bias.	—	
27	V _{DD4}	DAC power supply (+5V).	—	—
28	V _{SS4}	DAC ground.	—	—

FUNCTION BLOCK DESCRIPTIONS

1. Input clamp (CLAMP)
This block performs sync tip clamping of the composite video signal. It provides a feedback signal for clamping A/D-converted minimum data at Y/C separation to the internal DC bias level.
2. A/D converter (ADC)
This block comprises a high-speed series-parallel 8-bit A/D converter that accepts an input video signal of 1.5V_{p-p} (from sync level to 100% white level).
3. Line memory
This block consists of DRAM resident line memory for 1H delay. There are four pairs. The line memories are combined to produce a 3-line composite video signal for each TV system type.

1H delay of the line memory

TV SYSTEM	3.58NTSC	PAL	N-PAL	M-PAL	4.43NTSC
Delay (clock)	910	1,135	917	909	—

4. Band-pass filter (BPF)
In this block, with fsc as the center frequency of the BPF, the chrominance signal is extracted from the line-memory-delayed composite video signal. The same logic is used for NTSC, PAL, M-PAL and N-PAL input signals, but the characteristics differ since each TV system uses a different fsc and system clock. Since the BPF for the chrominance signal output can be controlled (ON or OFF), the chrominance output can therefore be switched between a narrow band width and a wide band width. This can be controlled by the I²C bus only in I²C bus control mode. In pin control mode, the chrominance output is set to a fixed wide band width. Separate BPF logic is used for the 4.43NTSC system type.

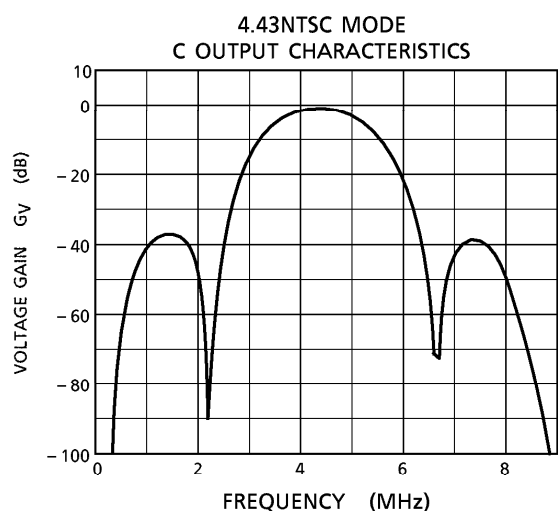
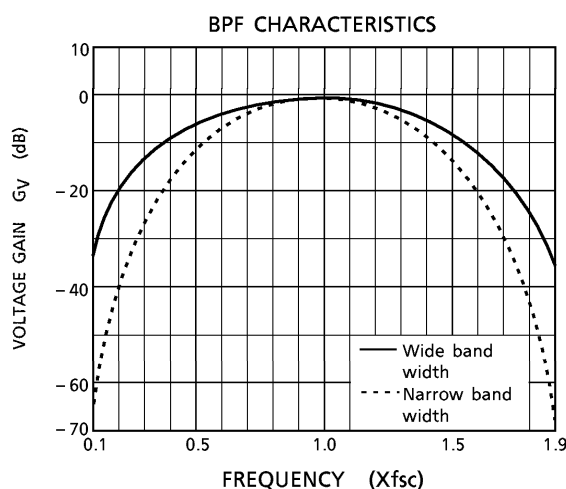

5. Dynamic comb filter (DCF)

This block comprises a band-pass filter that extracts the vertical component of the chrominance signal. Using Toshiba original logic, a correlation of the three lines is sought for. The absence of correlation is taken as an indication of a luminance signal, at which time chrominance signal output is suppressed.

6. Vertical edge enhancement circuit (VENH)

This block enhances the uncorrelated components among the three lines of the luminance signal following coring. The luminance signal, obtained by subtracting the chrominance signal from the composite video signal, is added to the vertical edge enhancement component and output through the D/A converter. However, this output signal is limited to the pedestal level (fixed internally) by the pedestal clipping circuit (except for the sync tip level). Eight levels of enhancement (0dB to 1.94dB) can be selected by I²C bus control and four levels of enhancement (0dB to 1.49dB) can be selected by pin control. This block can be used with any of the TV system types except SECAM.

(i) Input signal with edge component

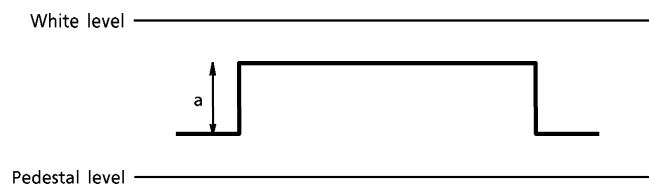

(ii) Output signal

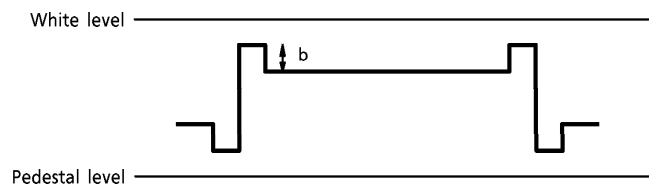

$$\text{Enhance level} = 20 \log \frac{a+b}{a} \text{ (dB)}$$

Vertical edge enhancement characteristic

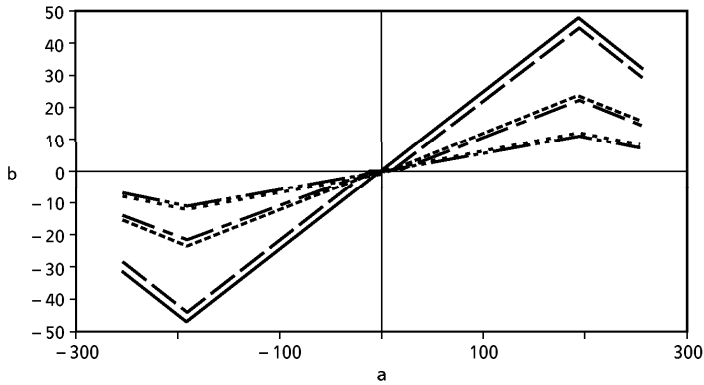

Vertical edge enhancement characteristic (Zoom)

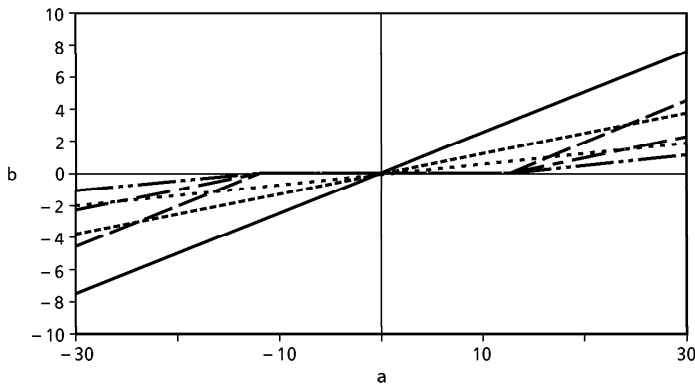

The relation between a and b.
 a : The difference of the luminance level in part of the edge.
 b : The component of vertical edge enhancement which is add to the luminance signal.
 Both are expressed by digital value.
 (However, this graph only shows adjustable enhance value of the device pin.)

- (A) Enhance Value : 1.49dB
- - (D) Enhance value : 1.49dB
- - - (B) 1.02dB
- · · · (C) 0.53dB
- · (E) 1.02dB
- · · (F) 0.53dB

A, B, C : Coring = OFF D, E, F : Coring = ON

7. 1-line dot interference correction

Previously, a 1-line-only chrominance signal was processed as a luminance signal resulting in dot crawl. This circuit prevents this problem by extracting the 1-line dot component and adding it to the DCF output. This function is used with the NTSC system only, and can be set ON or OFF under I²C bus control. Under pin control, it is always ON.

(i) Input signal

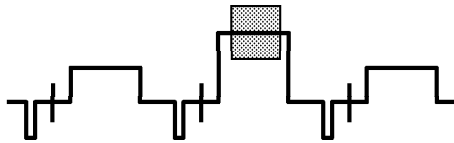

(ii) 1-line circuit output : OFF

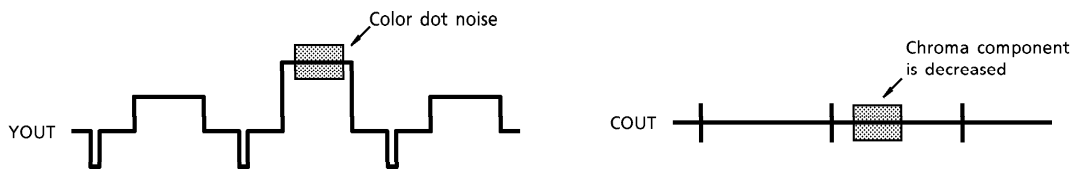

(iii) 1-line circuit output : ON

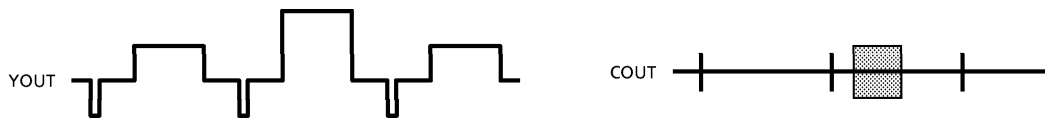

8. PLL (4x clock signal multiplier)

This block supplies a 4fsc (PLL 4x multiplied) signal for use as system clock. An fsc or 4fsc input clock is selectable under I²C bus control. Under pin control, the external clock signal is used, bypassing the PLL circuit.

9. Clock and memory timing generator (RTIM)

This block supplies a buffered system clock signal to the other circuit blocks, and also generates a timing signal for the memory blocks.

10. D/A converter (DAC)

This block comprises a high-speed 8bit D/A converter. It provides Y output at approximately 2.0V_{p-p} and burst-level C output at approximately 572mV_{p-p}.

SIGNAL FLOW

- Signal processing

TV SYSTEM	METHOD OF Y / C SEPARATION	VENH CIRCUIT	1-LINE DOT CORRECTION CIRCUIT
NTSC	3-line (0H, 1H, 2H)	○ (± 1H)	○
PAL	3-line (0H, 2H, 4H)	○ (± 1H)	—
N-PAL	3-line (0H, 2H, 4H)	○ (± 1H)	—
M-PAL	3-line (0H, 2H, 4H)	○ (± 1H)	—
4.43NTSC	Chroma BPF	○ (± 1H)	—
SECAM	Bypass (Input→ADC→DAC→Output)	—	—

- Signal flow chart
- 1. NTSC system

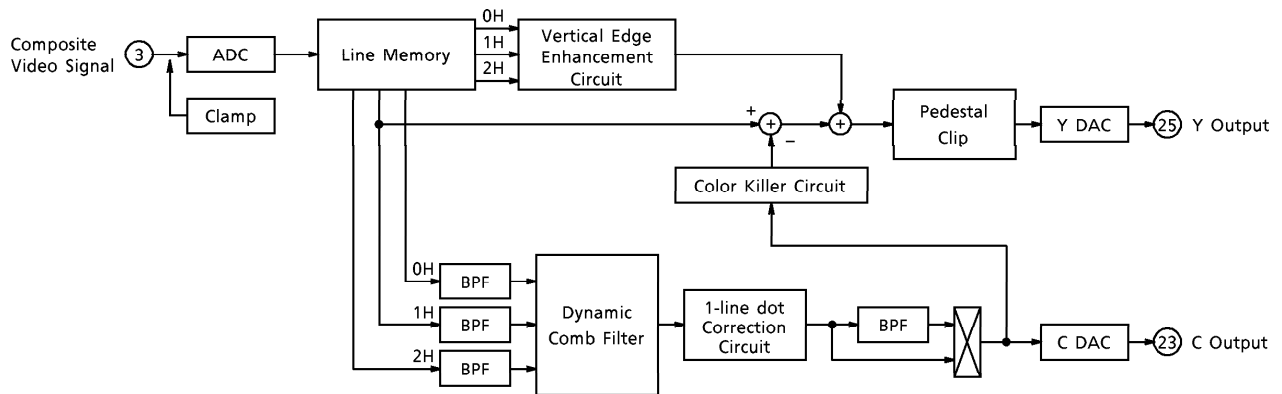

2. PAL, N-PAL, M-PAL systems

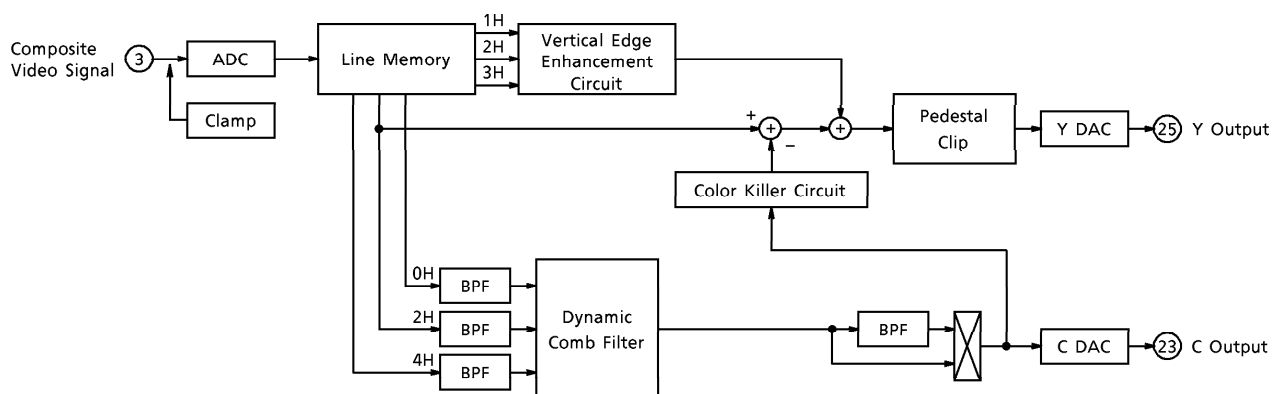

3. 4.43NTSC system

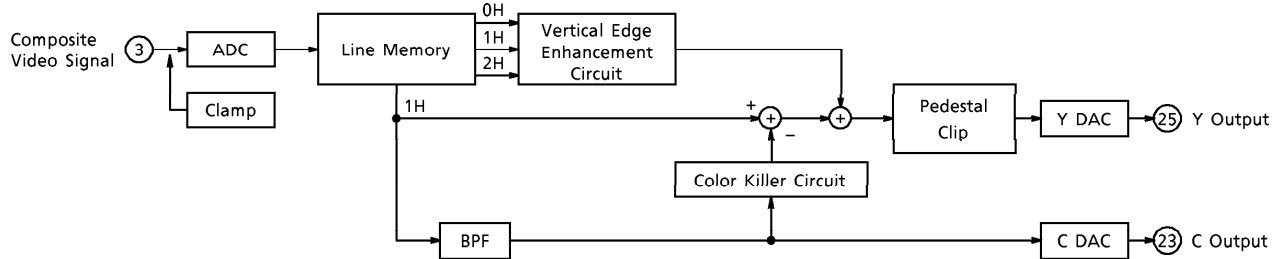

4. SECAM

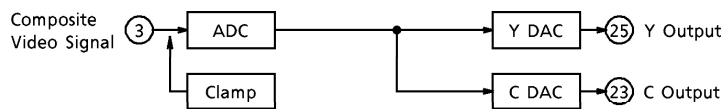

FUNCTION CONTROL

There are two ways to control TC9090AN and TC9090AF functions : through the I²C bus or through the device pins. The method used is selected with function control selector switch P/S (pin 7).

● **Function table**

FUNCTION	SYMBOL	CONTROL		MODE
		I ² C	PIN	
TV System Selector	TVSW	○	○	NTSC, PAL, N-PAL, M-PAL 4.43NTSC, SECAM
VENH Level Selector	VENH	○	○	I ² C bus control : 8 steps (0dB~1.94dB) Pin control : 4 steps (0dB~1.49dB)
Color Killer Switch	KILLER	○	○	Color, B/W
Coring Switch	CORING	○	ON	Coring circuit on, off
1-Line Dot Correction Switch	1LINE	○	ON	1-line dot correction circuit on, off
Chroma Band-Width Selector	CBPF	○	Wide	Wide band width, narrow band width
PLL Selector	PLLSEL	○	○	fsc input, 4fsc input (PLL off)

For KILLER and PLLSEL, pin control is also possible even in I²C bus control. When you set to "1" or "H" in either control, however, these settings have priority.

Example :

I²C bus : 1 Pin : L → I²C bus : 1 has priority.

I²C bus : 0 Pin : H → Pin : H has priority.

I²C BUS CONTROLLED FORMAT SUMMARY

Bus controlled format of TC9090AN and TC9090AF are based on I²C bus control format of Philips.

Data transfer format



(1) Start and stop condition

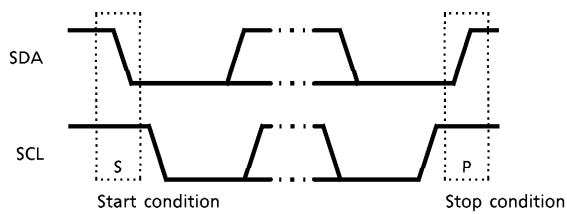

(2) Bit transfer

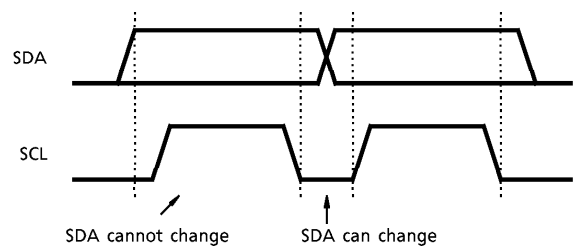

(3) Acknowledge

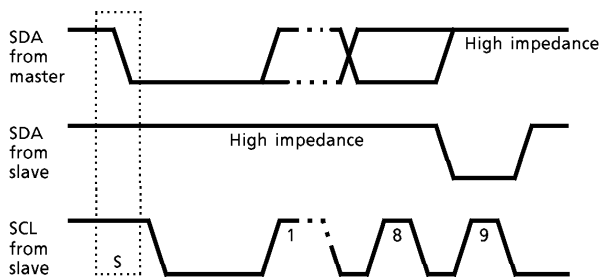

(4) Slave address

A6	A5	A4	A3	A2	A1	A0	R / \bar{W}
1	0	1	1	0	0	1	0

Purchase of TOSHIBA I²C components conveys a license under the Philips I²C Patent Rights to use these components in an I²C system, provided that the system conforms to the I²C Standard Specification as defined by Philips.

I²C BUS CONTROL DATA REGISTERS

Value in tables are default initialization values.

DATA1

MSB							LSB
TVSW1	TVSW2	TVSW3	VENH0	VENH1	VENH2	CBPF	KILLER
0	0	0	0	0	0	0	0

TVSW1~3 : Selects the TV system.
 000 = TEST (not used)
 001 = M-PAL
 010 = N-PAL
 011 = PAL
 100 = 4.43NTSC
 101 = SECAM
 110 = 3.58NTSC

VENH0~2 : Sets level of vertical edge enhancement.
 000 = 0dB
 001 = 0.27dB
 010 = 0.53dB
 011 = 0.78dB
 100 = 1.02dB
 101 = 1.26dB
 110 = 1.49dB
 111 = 1.94dB

CBPF : Selects the chroma output band width by switching on or off the BPF that follows DCF.
 0 = Wide band width
 1 = Narrow band width

KILLER : Switches color killer circuit.
 0 = Color mode (color killer circuit OFF)
 1 = B/W mode (color killer circuit ON)

DATA2

MSB							LSB
1LINEDOT 0	CORING 0	PLLSEL 0					

1LINEDOT : Switches 1-line dot correction circuit on or off.

0 = ON

1 = OFF

CORING : Switches coring circuit on or off.

0 = ON

1 = OFF

PLLSEL : Selects input clock frequency.

0 = fsc input, PLL circuit is used

1 = 4fsc input, PLL circuit is bypassed

PIN CONTROL

MODE	ACTION	PIN 7 P/S	PIN 8 SDA (TVSW1)	PIN 9 SCL (TVSW2)	PIN 10 RESET (TVSW3)	PIN 11 TEST1 (VENH0)	PIN 12 TEST2 (VENH1)	PIN 13 KILLER	PIN 14 PLLSEL
P/S	I ² C Control	L	—	—	—	—	—	—	—
	Pin Control	H	—	—	—	—	—	—	—
KILLER	Color	—	—	—	—	—	—	L	—
	B/W	—	—	—	—	—	—	H	—
TVSW	TEST	H	L	L	L	—	—	—	—
	M-PAL	H	L	L	H	—	—	—	—
	N-PAL	H	L	H	L	—	—	—	—
	PAL	H	L	H	H	—	—	—	—
	4.43NTSC	H	H	L	L	—	—	—	—
	SECAM	H	H	L	H	—	—	—	—
VENH	3.58NTSC	H	H	H	L	—	—	—	—
	VENH circuit OFF	H	—	—	—	L	L	—	—
	VENH level = 0.53dB	H	—	—	—	L	H	—	—
	VENH level = 1.02dB	H	—	—	—	H	L	—	—
PLLSEL	VENH level = 1.49dB	H	—	—	—	H	H	—	—
	fsc input	—	—	—	—	—	—	—	L
	4fsc input	—	—	—	—	—	—	—	H

RATINGS AND CHARACTERISTICS

The following specifications were obtained in part from the test circuit shown on page 19.

MAXIMUM RATINGS (Ta = 25°C)

CHARACTERISTIC	SYMBOL	RATING	UNIT	
Power Supply Voltage	V _{DD}	V _{SS} ~V _{SS} + 6.0	V	
Input Voltage	V _{IN}	-0.3~V _{DD} + 0.3	V	
Power Dissipation	TC9090AN	P _D (Note)	900	mW
	TC9090AF		600	
Storage Temperature	T _{stg}	- 55~125	°C	

(Note) Ta = 75°C

RECOMMENDED OPERATING CONDITIONS

CHARACTERISTIC	SYMBOL	TEST CONDITION	MIN.	TYP.	MAX.	UNIT
Power Supply Voltage	V _{DD}	—	4.75	5.00	5.25	V
Input Voltage	V _{IN}	—	0	—	V _{DD}	V
Operating Temperature	T _{opr}	—	- 10	—	75	°C

ELECTRICAL CHARACTERISTICS

DC CHARACTERISTICS (Ta = 25°C, V_{DD} = 5V)

CHARACTERISTIC	SYMBOL	TEST CIR-CUIT	TEST CONDITION	MIN.	TYP.	MAX.	UNIT	
Power Supply Voltage	V _{DD}	1	CLOCK = 4.43361875MHz (PAL) VREL1 = 3.0V 1 / 2V _{DD} = 2.5V V _{IN} = No input	4.75	5.00	5.25	V	
Supply Current	I _{DD}	1		60	80	100	mA	
Output Voltage Level	Y _{OUT}	1		2.9	3.0	3.2	V	
	C _{OUT}			3.8	4.0	4.2		
Pin Voltage Level	VREFL	1		1.2	1.5	1.8	V	
	VREFH			3.2	3.5	3.8		
	ADIN			1.3	1.6	1.9		
	BIAS1			0.9	1.3	1.7		
	BIAS2			1.0	1.6	2.2		
	BIAS3			2.5	3.5	4.5		
	VFIL			0.9	1.8	2.5		
CKIN	1.8	2.4		3.0				
Input Voltage	High Level	V _{IH}		1	4	—	—	V
	Low Level	V _{IL}		1	—	—	1	
ADIN Pin Input Capacitance	C _{IN}	1		—	50	—	pF	
Pull-Down Resistance	R _{pD}	1	25	50	100	kΩ		

AC CHARACTERISTICS

Y output (Ta = 25°C, VDD = 5V, VREF1 = 3.0V, Input Clock : fsc, 0.4Vp-p, S1 = 2)

CHARACTERISTIC			SYMBOL	TEST CIRCUIT	TEST CONDITION	MIN.	TYP.	MAX.	UNIT
Input Level			VIN	1	—	—	1.5	1.6	Vp-p
Low Frequency Gain			GV	1	S2 = 2, S3 = 2, S4 = 1, S5 = 2 VIN = fH 1.5Vp-p Vdc = 2.5V	-0.5	0.0	0.5	dB
3.58NTSC	Frequency Response	f2 / f1	FWNn	1	S2 = 2, S3 = 2, S4 = 1, S5 = 2 VIN = 1.5Vp-p Vdc = 2.5V Frequency response : Gain (fn) – Gain (f1), (n = 2, 4, 5) Comb characteristics : Gain (comb top) – Gain (comb bottom)	-2.5	-2.0	-0.9	dB
		f4 / f1	FWWn			-3.5	-2.5	-1.6	
Comb Characteristics	f2 / f3	YCOMn	40			45	—		
PAL	Frequency Response	f2 / f1	FWNp			-2.5	-2.0	-0.9	dB
		f4 / f1	FWWp			-3.5	-2.5	-1.6	
Comb Characteristics	f2 / f3	YCOMp	40			45	—		
N-PAL	Frequency Response	f2 / f1	FWNnp			-2.5	-2.0	-0.9	dB
		f4 / f1	FWWnp			-3.5	-2.5	-1.6	
Comb Characteristics	f2 / f3	YCOMnp	40			45	—		
M-PAL	Frequency Response	f2 / f1	FWNmp			-2.5	-2.0	-0.9	dB
		f4 / f1	FWWmp	-3.5	-2.5	-1.6			
Comb Characteristics	f2 / f3	YCOMmp	40	45	—				
4.43NTSC	Frequency Response	f5 / f1	FWN4n	-3.0	-2.5	-1.9	dB		
		f1 / f2	FWW4n	40	45	—			
Linearity	Y1 / Y2	Ls	Ls	1	S2 = 1, S3 = 1, S4 = 1, S5 = 2 VIN = 5-step signal 1.5Vp-p	37	40	43	%
		S / Y2				Ly	57	60	
Output Impedance			Zo	1	S2 = 2, S3 = 2, S5 = 2 VIN = fH 1.5Vp-p Vdc = 2.5V $Zo = \frac{V1 - V2}{V2} \times 300$ V1 : S4 = 1, V2 : S4 = 2	—	400	—	Ω

CHARACTERISTIC	SYMBOL	TEST CIR-CUIT	TEST CONDITION	MIN.	TYP.	MAX.	UNIT
Clock Leak (4fsc Components)	Lck	1	S2 = 2, S3 = 2, S4 = 1, S5 = 1 VIN = No input	—	5.0	20	mVrms
Fundamental Clock Leak (fsc Components)	Lsc	1	S2 = 2, S3 = 2, S4 = 1, S5 = 1 VIN = No input	—	1.0	2.0	mVrms

(Note) $f_1 = f_H$, $f_2 = f_{sc}$, f_3 (NTSC) = $f_{sc} + 1 / 2f_H$, f_3 (PAL) = $f_{sc} + 1 / 4f_H + 25\text{Hz}$, $f_4 = 3 / 4f_{sc}$

	3.58NTSC	PAL	N-PAL	M-PAL	4.43NTSC
f ₁	15734.26	15625.00	15625.00	15734.26	15750.00
f ₂	3579545.00	4433618.75	3582056.25	3575611.49	4433618.75
f ₃	3587412.13	4437550.00	3585987.50	3579545.06	—
f ₄	4772726.67	5911491.67	4776075.00	4767481.99	—
f ₅	—	—	—	—	3000000.00

Unit : Hz

C output (Ta = 25°C, VDD = 5V, VREF1 = 3.0V, Input Clock : fsc, 0.4Vp-p, S1 = 1)

CHARACTERISTIC		SYMBOL	TEST CIR-CUIT	TEST CONDITION	MIN.	TYP.	MAX.	UNIT
Gain		CV	1	S2 = 2, S3 = 2, S4 = 1, S5 = 1 VIN = 430mVp-p	-2.0	-1.5	-0.6	dB
3.58NTSC	BPF Characteristics	Wide	1	S2 = 2, S3 = 2, S4 = 1, S5 = 2 VIN = 1.5Vp-p Vdc = 2.5V (fsc - 503496Hz) - (fsc)	-0.5	-0.2	—	dB
		Narrow			-1	-0.5	—	
Comb Characteristics		CCOM _n	1	S2 = 2, S3 = 2, S4 = 1, S5 = 2 VIN = 430mVp-p Vdc = 2.5V	30	35	—	
PAL	BPF Characteristics	BW _p	1	S2 = 2, S3 = 2, S4 = 1, S5 = 2 VIN = 1.5Vp-p Vdc = 2.5V (fsc - 500000Hz) - (fsc)	-0.5	-0.2	—	dB
	Comb Characteristics	CCOM _p			S2 = 2, S3 = 2, S4 = 1, S5 = 2 VIN = 430mVp-p Vdc = 2.5V	30	35	

CHARACTERISTIC		SYMBOL	TEST CIR-CUIT	TEST CONDITION	MIN.	TYP.	MAX.	UNIT
N-PAL	BPF Characteristics	BW _{np}	1	S2 = 2, S3 = 2, S4 = 1, S5 = 2 V _{IN} = 1.5V _{p-p} , V _{dc} = 2.5V (fsc - 500000Hz) - (fsc)	-0.5	-0.2	—	dB
	Comb Characteristics	CCOM _{np}		S2 = 2, S3 = 2, S4 = 1, S5 = 2 V _{IN} = 430mV _{p-p} , V _{dc} = 2.5V	30	35	—	
M-PAL	BPF Characteristics	BW _{mp}	1	S2 = 2, S3 = 2, S4 = 1, S5 = 2 V _{IN} = 1.5V _{p-p} , V _{dc} = 2.5V (fsc - 503496Hz) - (fsc)	-0.5	-0.2	—	dB
	Comb Characteristics	CCOM _{mp}		S2 = 2, S3 = 2, S4 = 1, S5 = 2 V _{IN} = 430mV _{p-p} , V _{dc} = 2.5V	30	35	—	
4.43NTSC	BPF Characteristics	BWN _{4n}	1	S2 = 2, S3 = 2, S4 = 1, S5 = 2 V _{IN} = 1.5V _{p-p} , V _{dc} = 2.5V (fsc - F) - (fsc) BWN _{4n} : F = 500kHz BWW _{4n} : F = 1.5MHz	-3.0	-1.9	-1.5	dB
		BWW _{4n}			-20	-16	-13	
Differential Gain		DG	1	S2 = 2, S3 = 3, S4 = 1, S5 = 1 V _{IN} = 5-step signal Y = 140IRE C = 40IRE	0	2	5	%
Differential Phase		DP	1	DG = (Comax - Comin) / Comax	0	2	5	°
Output Impedance		Zo	1	S2 = 2, S3 = 2, S5 = 2 V _{IN} = f _H 1.5V _{p-p} , V _{dc} = 2.5V $Z_o = \frac{V_1 - V_2}{V_2} \times 300$ V1 : S4 = 1, V2 : S4 = 2	—	400	—	Ω
Clock Leak (4fsc Components)		Lck	1	S2 = 2, S3 = 2, S4 = 1, S5 = 1 V _{IN} = No input	—	5.0	20	mV _{rms}
Fundamental Clock Leak (fsc Components)		Lsc	1	S2 = 2, S3 = 2, S4 = 1, S5 = 1 V _{IN} = No input	—	0.3	1	mV _{rms}

PLL CIRCUIT CHARACTERISTICS

CHARACTERISTIC	SYMBOL	TEST CIR-CUIT	TEST CONDITION	MIN.	TYP.	MAX.	UNIT
Pull-In Frequency Range	fck	1	—	3.57	—	4.44	MHz
Input Amplitude (fsc Components)	Vck	1	—	0.3	0.4	—	V _{p-p}

PACKAGE DIMENSIONS
SOP28-P-450-1.27

Unit : mm

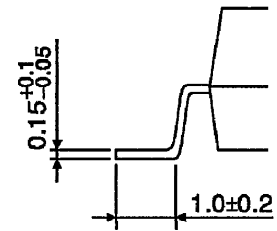
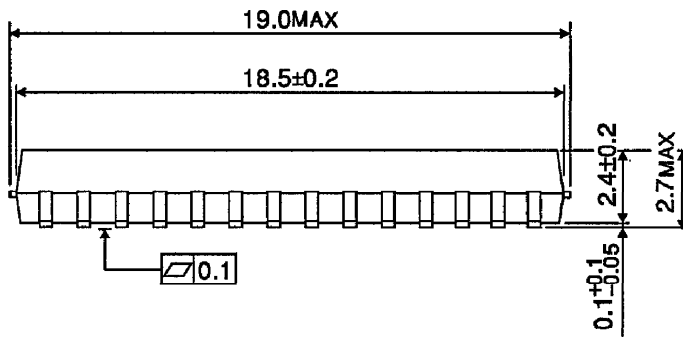
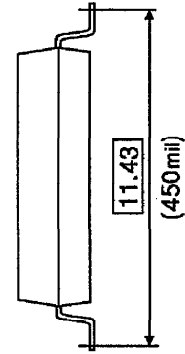
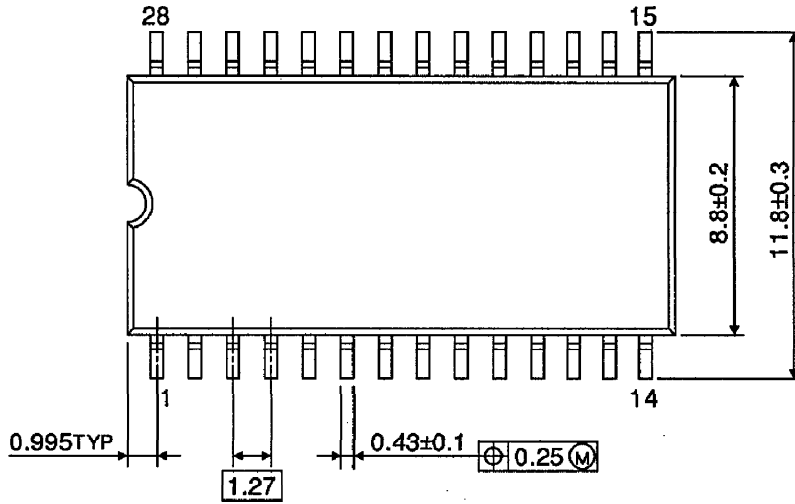

Weight : 0.8g (Typ.)

RESTRICTIONS ON PRODUCT USE

000707EBA

- TOSHIBA is continually working to improve the quality and reliability of its products. Nevertheless, semiconductor devices in general can malfunction or fail due to their inherent electrical sensitivity and vulnerability to physical stress. It is the responsibility of the buyer, when utilizing TOSHIBA products, to comply with the standards of safety in making a safe design for the entire system, and to avoid situations in which a malfunction or failure of such TOSHIBA products could cause loss of human life, bodily injury or damage to property. In developing your designs, please ensure that TOSHIBA products are used within specified operating ranges as set forth in the most recent TOSHIBA products specifications. Also, please keep in mind the precautions and conditions set forth in the "Handling Guide for Semiconductor Devices," or "TOSHIBA Semiconductor Reliability Handbook" etc..
- The TOSHIBA products listed in this document are intended for usage in general electronics applications (computer, personal equipment, office equipment, measuring equipment, industrial robotics, domestic appliances, etc.). These TOSHIBA products are neither intended nor warranted for usage in equipment that requires extraordinarily high quality and/or reliability or a malfunction or failure of which may cause loss of human life or bodily injury ("Unintended Usage"). Unintended Usage include atomic energy control instruments, airplane or spaceship instruments, transportation instruments, traffic signal instruments, combustion control instruments, medical instruments, all types of safety devices, etc.. Unintended Usage of TOSHIBA products listed in this document shall be made at the customer's own risk.
- The products described in this document are subject to the foreign exchange and foreign trade laws.
- The information contained herein is presented only as a guide for the applications of our products. No responsibility is assumed by TOSHIBA CORPORATION for any infringements of intellectual property or other rights of the third parties which may result from its use. No license is granted by implication or otherwise under any intellectual property or other rights of TOSHIBA CORPORATION or others.
- The information contained herein is subject to change without notice.

This datasheet has been download from:

www.datasheetcatalog.com

Datasheets for electronics components.