

TOSHIBA CMOS DIGITAL INTEGRATED CIRCUIT SILICON MONOLITHIC

TC9307AF-010

SINGLECHIP DTS MICRO CONTROLLER (DTS-12)

The TC9307AF-010 is a digital tuning system optimum for such portable audio equipment as radio with a cassette tape recorder, and is provided with 4 bands of FM/SW/MW/LW and compatible with worldwide destinations.

FEATURES

○ RECEIVING BAND

AREA	CODE			STEP JAMPER	BAND	RECEIVING FREQUENCY [Hz]	STEP [Hz]	REFERENCE FREQUENCY [Hz]	INTERMEDIATE FREQUENCY [Hz]
	E0	E1	E2						
USA 1	0	0	0	—	FM	87.5~ 107.9M	200k	25k	+ 10.7M
					MW	530~ 1710k	10k	5k	+ 450k
USA 2	0	0	1	—	FM	87.5~ 108.0M	100k	25k	+ 10.7M
					MW	530~ 1710k	10k	5k	+ 450k
GENERAL SW-A	0	1	0	0 / 1	FM	87.50~108.00M	50 / 100k	25k	+ 10.7M
				0	MW	531~ 1602k	9k	3k	+ 450k
				1		530~ 1610k	10k	5k	
				—	LW	146~ 281k	1k	1k	
—	SW	5.95~ 15.6M	5k	5k					
EUROPE	0	1	1	0 / 1	FM	87.50~108.00M	50 / 100k	25k	+ 10.7M
				0	MW	531~ 1602k	9k	3k	+ 450k
				1		530~ 1610k	10k	5k	
				—	LW	146~ 281k	1k	1k	
MIDDLE EAST	1	0	0	0 / 1	FM	87.50~108.00M	50 / 100k	25k	
				0	MW	531~ 1602k	9k	3k	+ 450k
				1		530~ 1610k	10k	5k	
				—	SW ₁	2.3~ 6.2M	5k	5k	
—	SW ₂	7.1~ 21.85M							
GENERAL SW-B	1	0	1	0 / 1	FM	87.50~108.00M	50 / 100k	25k	+ 10.7M
				0	MW	531~ 1602k	9k	3k	+ 450k
				1		530~ 1610k	10k	5k	
				—	LW	146~ 281k	1k	1k	
—	SW	3.8~ 12.5M	5k	5k					
AUSTRALIA	1	1	0	0 / 1	FM	87.50~108.00M	50 / 100k	25k	+ 10.7M
				0	MW	531~ 1602k	9k	3k	+ 450k
				1		530~ 1610k	10k	5k	

980910EBA2

- TOSHIBA is continually working to improve the quality and the reliability of its products. Nevertheless, semiconductor devices in general can malfunction or fail due to their inherent electrical sensitivity and vulnerability to physical stress. It is the responsibility of the buyer, when utilizing TOSHIBA products, to observe standards of safety, and to avoid situations in which a malfunction or failure of a TOSHIBA product could cause loss of human life, bodily injury or damage to property. In developing your designs, please ensure that TOSHIBA products are used within specified operating ranges as set forth in the most recent products specifications. Also, please keep in mind the precautions and conditions set forth in the TOSHIBA Semiconductor Reliability Handbook.
- The products described in this document are subject to the foreign exchange and foreign trade laws.
- The information contained herein is presented only as a guide for the applications of our products. No responsibility is assumed by TOSHIBA CORPORATION for any infringements of intellectual property or other rights of the third parties which may result from its use. No license is granted by implication or otherwise under any intellectual property or other rights of TOSHIBA CORPORATION or others.
- The information contained herein is subject to change without notice.

AREA	CODE			STEP JAMPER	BAND	RECEIVING FREQUENCY [Hz]	STEP [Hz]	REFERENCE FREQUENCY [Hz]	INTERMEDIATE FREQUENCY [Hz]
	E0	E1	E2						
CHINA	1	1	1	0 / 1	FM	87.00 ~ 108.00M	50 / 100k	25k	+ 10.7M
				—	MW	531 ~ 1602k	9k	3k	+ 450k
				—	SW ₁	2.3 ~ 6.2M	5k	5k	
					SW ₂	7.1 ~ 21.85M			

○ **FUNCTIONAL OUTLINE**

- Manual Up/Down Tuning
- Auto Up/Down Tuning (seek system)
- IF counter system auto stop function.
- Auto tuning in SW band is the scan system in the meter band.
- Band changeover of method to which either of momentary or lock switch is selectable.
- ON/OFF timer by time set system.
- 12-hour/24-hour clock
- Sleep timer (max 90 min.)
- snooze (within 2 hours)

TC9307AF-010 Layout

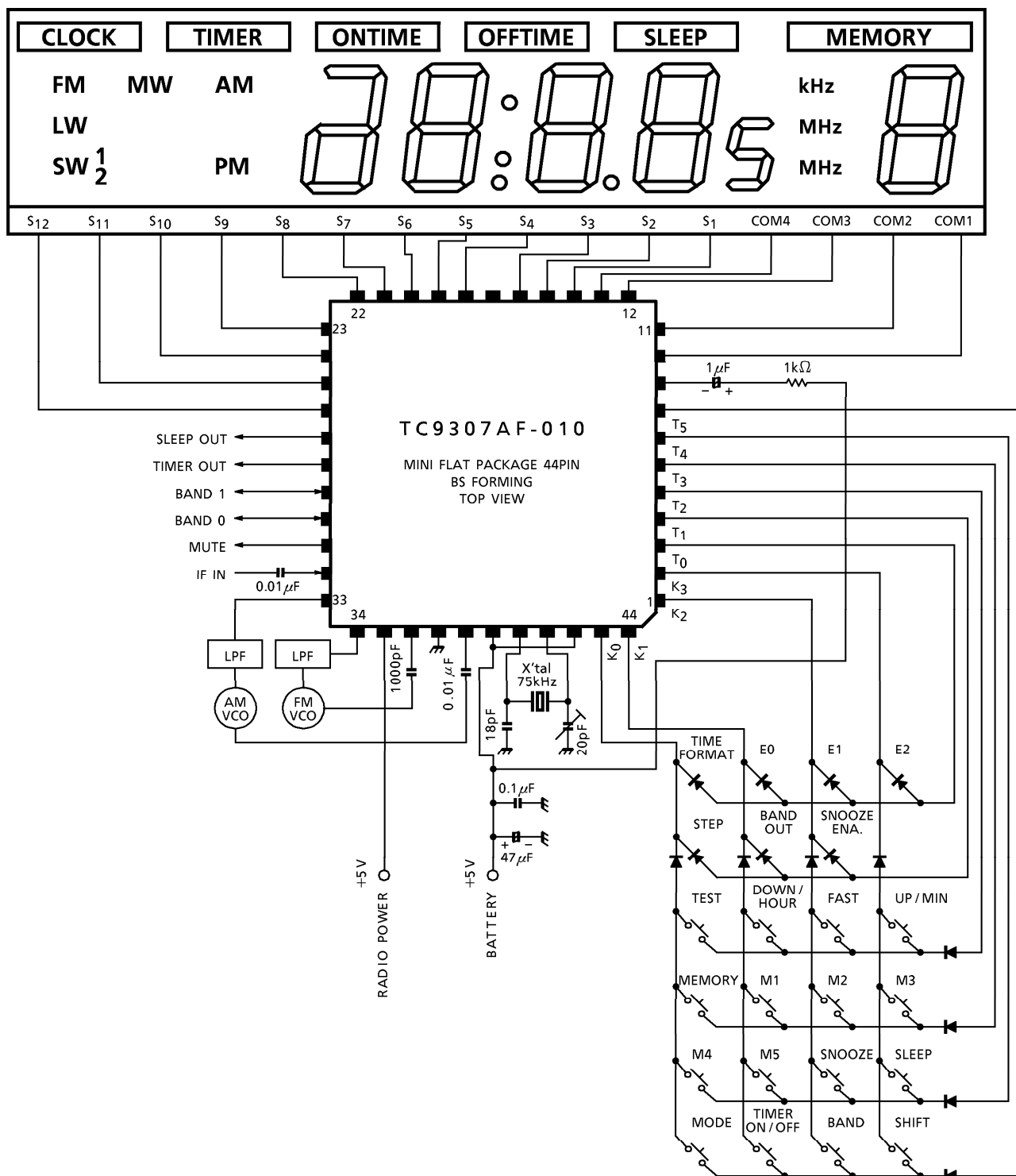

KEY MAP

	T ₀	T ₁	T ₂	T ₃	T ₄	T ₅
K ₃	* E2		UP min	M3	SLEEP	SHIFT
K ₂	* E1	* SNOOZE ENABLE	FAST	M2	SNOOZE	BAND
K ₁	* E0	* BAND OUT	DOWN hour	M1	M5	TIMER ON/OFF
K ₀	* TIME FORMAT	* 9k 10k	TEST	MEMORY	M4	MODE

* Diode jumper

LCD MAP

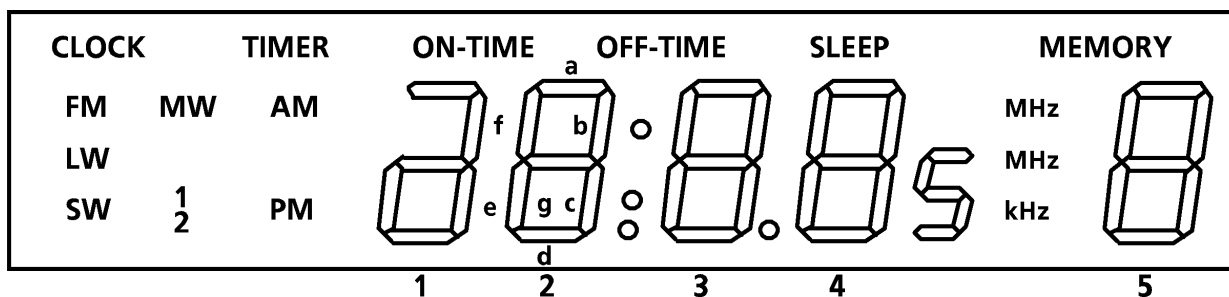

SYMBOL	PIN No.	SEGMENT NAME				COMMENT
		COM1	COM2	COM3	COM4	
S ₁₂	26	5	FM. MHz	kHz	PM	21.845MHz
S ₁₁	25	SW. MHz	:	2	CLOCK	SW <u>2</u>
S ₁₀	24	MW	1	LW	AM	SW <u>1</u>
S ₉	23	1c	1adeg	1b	TIMER	<u>2</u> 1.845MHz
S ₈	22	2d	2e	2f	ON-TIME	<u>2</u> 1.845MHz
S ₇	21	2c	2g	2b	2a	
S ₆	20	3d	3e	3f	OFF-TIME	21.845MHz
S ₅	19	3c	3g	3b	3a	
S ₄	18	4d	4e	4f	SLEEP	21.845MHz
S ₃	16	4c	4g	4b	4a	
S ₂	15	5d	5e	5f	MEMORY	PRESET CH
S ₁	14	5c	5g	5b	5a	

PUSH KEY

SYMBOL	FUNCTIONAL DESCRIPTION
UP min	FREQ : Press briefly, frequency will be advanced by one step at each time this button pressed. Press continuously for more than 1s., seek-up tuning mode is result. Scanner looks for the nearest station with sufficient signal strength. TIME : When correcting a time or setting a timer, MINUTE digit is set.
FAST	FREQ : Simultaneously pressing UP (or DOWN) button and FAST button will accelerates the manual tuning. Seek tuning mode will be disable when FAST button is pressed.
DOWN hour	FREQ : Press briefly, frequency will be advanced by one step at each time this button pressed. Press continuously for more than 1s., seek-down tuning mode is result. Scanner looks for the nearest station with sufficient signal strength. TIME : When correcting a time or setting a timer, HOUR digit is set.
MEMORY	FREQ : While this button is pressed, memory write function is enabled for a time period of 4s. After the time period, memory write function will disable automatically. TIME : Continuously pressing this button will enable time or timer correction function. Time or timer correction function will be disable again once this button is released. This is a security function to avoid misalignment of the time or timer accidentally.
BAND	When [BAND OUT] jumper is valid, briefly press this button will alter the radio band in a cyclic function.
M1~M5	Address to a memory location when recall a preset memory or write to a memory.
SHIFT	For some destinations, 10 preset memories is provided. [SHIFT] key is useful for the addressing of M6-M10. To do so, push SHIFT key and then push M1-M5.
(TEST)	As long as this key is kept pushed, all indications on LCD are kept ON. Further, this is capable of checking the timer and sleep functions by accelerating the clock.
SNOOZE	To temporary stop the timer function for a time interval of 9 min. After this time interval, timer function will resume.
SLEEP	SLEEP timer can be turned ON and OFF by a momentarily switch in a cyclic function. To alter the sleep time, push SLEEP button to activate the SLEEP timer and continuously pushing this button for more than 1s, a sleep time can be set up at an interval of 0.5s/step like 90, 80,.....10, 1, 90.
MODE	Switches the operation among FREQUENCY, CLOCK and TIMER mode cyclically.

FUNCTION (Diode jumper)

SYMBOL	FUNCTION DESCRIPTION																																							
E0~E2	<p>Set up a destination</p> <table border="1" data-bbox="395 450 833 813"> <thead> <tr> <th colspan="3">DIODE</th> <th rowspan="2">DESTINATION</th> </tr> <tr> <th>E0</th> <th>E1</th> <th>E2</th> </tr> </thead> <tbody> <tr> <td></td> <td></td> <td></td> <td>USA 1</td> </tr> <tr> <td></td> <td></td> <td>○</td> <td>USA 2</td> </tr> <tr> <td></td> <td>○</td> <td></td> <td>General (SW-A type)</td> </tr> <tr> <td></td> <td>○</td> <td>○</td> <td>Europe</td> </tr> <tr> <td>○</td> <td></td> <td></td> <td>Middle & Near East</td> </tr> <tr> <td>○</td> <td></td> <td>○</td> <td>General (SW-B type)</td> </tr> <tr> <td>○</td> <td>○</td> <td></td> <td>Canada Australia</td> </tr> <tr> <td>○</td> <td>○</td> <td>○</td> <td>China</td> </tr> </tbody> </table> <p>○ : Diode is available</p>	DIODE			DESTINATION	E0	E1	E2				USA 1			○	USA 2		○		General (SW-A type)		○	○	Europe	○			Middle & Near East	○		○	General (SW-B type)	○	○		Canada Australia	○	○	○	China
DIODE			DESTINATION																																					
E0	E1	E2																																						
			USA 1																																					
		○	USA 2																																					
	○		General (SW-A type)																																					
	○	○	Europe																																					
○			Middle & Near East																																					
○		○	General (SW-B type)																																					
○	○		Canada Australia																																					
○	○	○	China																																					
Time Format	<p>To select 12 hour format or 24 hour format. With diode jumper : 24 hour format. Without diode jumper : 12 hour format.</p>																																							
9k 10k	<p>selects AM / FM step. Without the jumper : MW 10k / FM 100k step With the jumper : MW 9k / FM 50k step However, FM band for USA, Canada, Australia, and MW band for China is fixed step.</p>																																							
BAND OUT	<p>With diode jumper : The band changeover of cyclical method can be carried out by [BAND] key. Without diode jumper : Selects receiving bands according to combination of the band input ports B0 and B1.</p>																																							

The diode jumper is read when a radio is turned ON or there is key input.

I/O PORT

PORT	No.	NAME	I/O	FUNCTION	ACTIVE	INIT.																													
P10	30	B0	IN	Without [band out] jumper	—	—																													
				<table border="1"> <thead> <tr> <th>B1</th> <th>B0</th> <th>USA Can.</th> <th>Gen. SW-A</th> <th>M.N. EAST china</th> <th>Euro</th> <th>Gen. SW-B</th> </tr> </thead> <tbody> <tr> <td>0</td> <td>0</td> <td>FM</td> <td>FM</td> <td>FM</td> <td>FM</td> <td>FM</td> </tr> <tr> <td>0</td> <td>1</td> <td>FM</td> <td>LW</td> <td>SW₁</td> <td>LW</td> <td>LW</td> </tr> <tr> <td>1</td> <td>0</td> <td>MW</td> <td>MW</td> <td>MW</td> <td>MW</td> <td>MW</td> </tr> <tr> <td>1</td> <td>1</td> <td>FM</td> <td>SW-A</td> <td>SW₂</td> <td>FM</td> <td>SW-B</td> </tr> </tbody> </table>			B1	B0	USA Can.	Gen. SW-A	M.N. EAST china	Euro	Gen. SW-B	0	0	FM	FM	FM	FM	FM	0	1	FM	LW	SW ₁	LW	LW	1	0	MW	MW	MW	MW	MW	1
B1	B0	USA Can.	Gen. SW-A	M.N. EAST china	Euro	Gen. SW-B																													
0	0	FM	FM	FM	FM	FM																													
0	1	FM	LW	SW ₁	LW	LW																													
1	0	MW	MW	MW	MW	MW																													
1	1	FM	SW-A	SW ₂	FM	SW-B																													
P11	29	B1	IN	With [band out] jumper	—	—																													
				<table border="1"> <thead> <tr> <th>B1</th> <th>B0</th> <th>USA Can.</th> <th>Gen. SW-A</th> <th>M.N. EAST china</th> <th>Euro</th> <th>Gen. SW-B</th> </tr> </thead> <tbody> <tr> <td>0</td> <td>0</td> <td>FM</td> <td>FM</td> <td>FM</td> <td>FM</td> <td>FM</td> </tr> <tr> <td>0</td> <td>1</td> <td>FM</td> <td>LW</td> <td>SW₁</td> <td>LW</td> <td>LW</td> </tr> <tr> <td>1</td> <td>0</td> <td>MW</td> <td>MW</td> <td>MW</td> <td>MW</td> <td>MW</td> </tr> <tr> <td>1</td> <td>1</td> <td>FM</td> <td>SW-A</td> <td>SW₂</td> <td>FM</td> <td>SW-B</td> </tr> </tbody> </table>			B1	B0	USA Can.	Gen. SW-A	M.N. EAST china	Euro	Gen. SW-B	0	0	FM	FM	FM	FM	FM	0	1	FM	LW	SW ₁	LW	LW	1	0	MW	MW	MW	MW	MW	1
B1	B0	USA Can.	Gen. SW-A	M.N. EAST china	Euro	Gen. SW-B																													
0	0	FM	FM	FM	FM	FM																													
0	1	FM	LW	SW ₁	LW	LW																													
1	0	MW	MW	MW	MW	MW																													
1	1	FM	SW-A	SW ₂	FM	SW-B																													
P10	30	B0	OUT	Without [band out] jumper	—	L																													
				<table border="1"> <thead> <tr> <th>B1</th> <th>B0</th> <th>USA Can.</th> <th>Gen. SW-A</th> <th>M.N. EAST china</th> <th>Euro</th> <th>Gen. SW-B</th> </tr> </thead> <tbody> <tr> <td>0</td> <td>0</td> <td>FM</td> <td>FM</td> <td>FM</td> <td>FM</td> <td>FM</td> </tr> <tr> <td>0</td> <td>1</td> <td>FM</td> <td>LW</td> <td>SW₁</td> <td>LW</td> <td>LW</td> </tr> <tr> <td>1</td> <td>0</td> <td>MW</td> <td>MW</td> <td>MW</td> <td>MW</td> <td>MW</td> </tr> <tr> <td>1</td> <td>1</td> <td>FM</td> <td>SW-A</td> <td>SW₂</td> <td>FM</td> <td>SW-B</td> </tr> </tbody> </table>			B1	B0	USA Can.	Gen. SW-A	M.N. EAST china	Euro	Gen. SW-B	0	0	FM	FM	FM	FM	FM	0	1	FM	LW	SW ₁	LW	LW	1	0	MW	MW	MW	MW	MW	1
B1	B0	USA Can.	Gen. SW-A	M.N. EAST china	Euro	Gen. SW-B																													
0	0	FM	FM	FM	FM	FM																													
0	1	FM	LW	SW ₁	LW	LW																													
1	0	MW	MW	MW	MW	MW																													
1	1	FM	SW-A	SW ₂	FM	SW-B																													
P11	29	B1	OUT	With [band out] jumper	—	L																													
				<table border="1"> <thead> <tr> <th>B1</th> <th>B0</th> <th>USA Can.</th> <th>Gen. SW-A</th> <th>M.N. EAST china</th> <th>Euro</th> <th>Gen. SW-B</th> </tr> </thead> <tbody> <tr> <td>0</td> <td>0</td> <td>FM</td> <td>FM</td> <td>FM</td> <td>FM</td> <td>FM</td> </tr> <tr> <td>0</td> <td>1</td> <td>FM</td> <td>LW</td> <td>SW₁</td> <td>LW</td> <td>LW</td> </tr> <tr> <td>1</td> <td>0</td> <td>MW</td> <td>MW</td> <td>MW</td> <td>MW</td> <td>MW</td> </tr> <tr> <td>1</td> <td>1</td> <td>FM</td> <td>SW-A</td> <td>SW₂</td> <td>FM</td> <td>SW-B</td> </tr> </tbody> </table>			B1	B0	USA Can.	Gen. SW-A	M.N. EAST china	Euro	Gen. SW-B	0	0	FM	FM	FM	FM	FM	0	1	FM	LW	SW ₁	LW	LW	1	0	MW	MW	MW	MW	MW	1
B1	B0	USA Can.	Gen. SW-A	M.N. EAST china	Euro	Gen. SW-B																													
0	0	FM	FM	FM	FM	FM																													
0	1	FM	LW	SW ₁	LW	LW																													
1	0	MW	MW	MW	MW	MW																													
1	1	FM	SW-A	SW ₂	FM	SW-B																													
P12	28	TIMER OUT	OUT	This port is put at "H" level during the timer operation.	H	L																													
P13	27	SLEEP OUT	OUT	This port is put at "H" level during the SLEEP period.	H	L																													
MUTE	31	MUTE	OUT	Muting output	H	L																													
INH	35	INH	IN	INH = 'H' : radio function is active. INH = 'L' : radio function is stop and clock mode.	—	—																													

BAND SWITCHING

1. Principal function

Bands are switched.

2. Input ports and keys to be used.

B0, B1, [BAND] key, [band out] diode switch

3. Function

When [band out] diode switch is OFF.

- a. Selects receiving bands according to combination of the band input ports B0 and B1.
- b. Bands selected according to destination are as follows :

INPUT PORT		U.S.A CANADA (2 BAND)	EUROPE (3 BAND)	M.N. EAST CHINA (4 BAND)	GENERAL (1) (4 BAND)	GENERAL (2) (4 BAND)
P11	P10					
0	0	FM	FM	FM	FM	FM
0	1	(FM)	LW	SW ₁	LW	LW
1	0	AM	MW	MW	MW	MW
1	1	(FM)	(FM)	SW ₂	SW-A	SW-B

When [band out] diode switch is ON.

- a. When [BAND OUT] jumper is valid, briefly press this button will alter the radio in a cyclic function.

Europe area



Middle Near East & China area

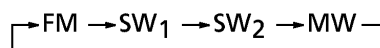

Other area

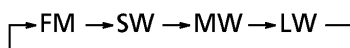

U.S.A & Canada area

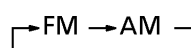

MANUAL TUNING

1. Principal function

1 push / 1 step tuning by [UP]/[DOWN] key.

2. Input ports and keys to be used.

[UP] key, [DOWN] key, [FAST] key

3. Function

a. 1 push / 1 step tuning by [UP]/[DOWN] key.

b. Tuning is continuously carried out when [UP]/[DOWN] key is kept pushed continuously for more than 1 second.

c. When [FAST] key is kept pushed together with [UP]/[DOWN] key, the high speed continuous tuning results. During the high speed continuous tuning, the continuous tuning up/down step frequency normally changes as follows :

BAND	SCAN TIME	STEP FREQUENCY	
		NORMAL	ACCELERATED
FM	100ms / STEP	100kHz	200kHz
		50kHz	200kHz
MW	200ms / STEP	9kHz	18kHz
		10kHz	20kHz
LW	200ms / STEP	1kHz	2kHz
SW	200ms / STEP	5kHz	100kHz

However, in SW band, if frequency below 0.1MHz is not zero when [UP]/[DOWN] key and [FAST] key are pushed, after the up/down tuning as follows, the up/down tuning at 100kHz is carried out.

In case of 16.555MHz

[UP] + [FAST]

16.555MHz→16.600MHz→16.700MHz~→

[DOWN] + [FAST]

16.555MHz→16.500MHz→16.400MHz~→

d. During the continuous tuning, any other key input is not accepted and even a broadcasting station is detected, it is not stopped.

e. If the upper limit frequency is reached, it shifts toward the lower limit frequency and when the lower limit frequency is reached, it shifts toward the upper limit frequency.

At this time, the system stops for 500ms as frequency.

AUTO SEARCH TUNING

1. Principal function

Continuously pressing [UP]/[DOWN] key for 1s, auto seek function will be activated.

2. Input ports and keys to be used.

[UP] key, [DOWN] key

3. Function

- a. Continuously pressing [UP] key for 1s, auto seek-up function will be activated. Similarly, Continuously pressing [DOWN] key for 1s, auto seek-down function will be activated.
- b. The auto tuning speed is the same as the continuous tuning speed. However, in the SW band, the inside of the meter band only is scanned at 5kHz per step.
- c. If STOP signal is detected by IF counter input, the tuning stops at that frequency.
- d. Meter band frequencies in SW band are as follows :

BAND	FREQUENCY	STEP
SW ₁	2.300~ 2.495	5kHz
	3.200~ 3.400	
	3.900~ 4.000	
	4.750~ 5.060	
	5.950~ 6.200	
SW ₂	7.100~ 7.300	5kHz
	9.500~ 9.900	
	11.650~12.050	
	13.600~13.800	
	15.100~15.600	
	17.550~17.900	
	21.450~21.850	

BAND	FREQUENCY	STEP
SW-A	5.950~ 6.200	5kHz
	7.100~ 7.300	
	9.500~ 9.900	
	11.650~12.050	
	13.600~13.800	
	15.100~15.600	

BAND	FREQUENCY	STEP
SW-B	3.900~ 4.000	5kHz
	4.750~ 5.060	
	5.950~ 6.200	
	7.100~ 7.300	
	9.500~ 9.900	
	11.650~12.050	

PRESET MEMORY

1. Principal function

The number of preset memories set up by destination can be realized.

2. Input ports and keys to be used.

- [M1]~[M5] key : Specification for Middle Near East and China
- [M1]~[M5] key, [SHIFT] key (M6~M10) : Specification for other zones

3. Function

- a. When [M1]~[M5] keys for the specifications for the Middle Near East and China are pushed, the pushed preset memories are read out.
- b. For the specification for other areas, when [M1]~[M10] keys are pushed, the pushed preset memories are read out. In this case, [M6]~[M10] keys become effective by pushing [M1]~[M5] keys after pushing [SHIFT] key.
Pushing [SHIFT] key result in the shift mode but no indication is made, and the shift mode is released when [SHIFT] key is pushed again.
- c. When [MEMORY] key is pushed, 'MEMORY' indication lights for 4s. and during this period if the preset key is pushed, a frequency is written in that preset memory and lighting of 'MEMORY' indication ends.
'MEMORY' indication also goes out by any key input other than [SHIFT] key and [FAST] key and the write status is canceled.
- d. Preset number is indicated on LCD but in case of CH 10, '0' is indicated.
- e. Destinations, receiving bands and number of preset memory channels are as follows :

DIODE			FM	MW	LW	SW			REMARK
E0	E1	E2				SW	SW ₁	SW ₂	
			10	10	—	—	—	—	USA 1
		○	10	10	—	—	—	—	USA 2
	○		10	5	5	5	—	—	Gen. SW-A
	○	○	10	5	5	—	—	—	Europe
○			5	5	—	—	5	5	M.N.East
○		○	10	5	5	5	—	—	Gen. SW-B
○	○		10	10	—	—	—	—	Canada
○	○	○	5	5	—	—	5	5	China

○ : with diode

CLOCK FUNCTION

1. Principal function

Corrects a current time.

2. Input ports and keys to be used.

[UP] key, [DOWN] key, [MEMORY] key, [MODE] key

3. Function

- a. Sets the clock indication with the [MODE] key.
- b. Push the [C-adj] key, the same key as the [MEMO] key. Press the [HOUR] ([MIN]) key in combination with the [C-adj] key to advance the hour (minute) digit.
- c. After timer correction is completed, press the [MODE] key repeatedly until the desired display mode is shown.
- d. When correcting "MIN.", s. is cleared to "00" if any key input is made.

SLEEP TIMER

1. Principal function

The 90 min. sleep timer can be set.

2. Input ports and keys to be used.

[SLEEP] key

3. Function

- a. When [SLEEP] key is pushed, the sleep out (P13) is put at "H" level, 'SLEEP' and a sleep time are indicated on LCD, and a 90 min. sleep time is set up. Further, if [SLEEP] key is pushed again, the sleep operation is released and the sleep out (P13) is put at "L" level.
- b. To change a sleep time, directly push [SLEEP] key continuously for more than 1s. when setting the sleep operation. A sleep time can be set up at intervals of 0.5s./step like 90, 80, ... 10, 1, 90.
- c. There is no indication for residual sleep time and if there is not [SLEEP] key input for 10s., the system returns to a mode before pushing [SLEEP] key.

TIMER FUNCTION

1. Principal function

Setting of the timer ON/OFF time and timer operation. (only SNOOZE disable mode)

2. Input ports and keys to be used.

[TIMER] key, [MODE] key, [HOUR] (UP) key, [MIN] (DOWN) key, [MEMO] key

3. Function

- a. [MODE] key operations among frequency, clock and timer mode cyclically. The timer correction function is automatically released after 10s. if no key input. Then, a current time is indicated.

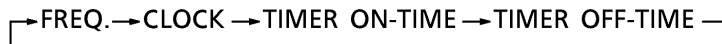

To check the ON-TIME (OFF-TIME) of the timer.

To push the [MODE] key repeatedly until the ON-TIME (OFF-TIME) is displayed.

To correct the ON-TIME (OFF-TIME) of the timer.

1. Push the [MODE] key repeatedly until the ON-TIME (OFF-TIME) is displayed.
2. Push the [C-adj] key, the same key as the [MEMO] key, the ON-TIME (OFF-TIME) indicator on the display will be flicker. Press the [HOUR] ([MIN]) key in combination with the [C-adj] key to advance the hour (minute) digit.
3. After timer correction is completed, press the [MODE] key repeatedly until the desired display mode is shown.

- b. [TIMER] key operations between TIMER-STANDBY and TIMER-OFF mode cyclically.

SNOOZE FUNCTION

1. Principal function

Setting of the timer ON time and SNOOZE operation.

2. Input ports and keys to be used.

[SNOOZE] key

3. Function

- a. When [SNOOZE ena] diode jumper ON, timer function change to snooze function. [MODE] key operations among frequency, clock and timer mode cyclically. The time correction function is automatically released after 10s. if no key input. Then, a current time is indicated.

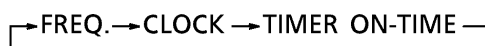

- b. At the TIMER ON-TIME, timer-out (P12) changes from "L" to "H".
- c. If [SNOOZE] key pushed on the TIMER-ON state, timer-out (P12) changes from "H" to "L". After 9 minutes, timer-out (P12) changes from "L" to "H" again. This function is available within 2 hours time.

MUTE

1. Principal function

In the following cases, mute signal (H active) is output.

2. Input ports and keys to be used.

Mute port (Pin 31)

3. Function

a. In the following cases, mute signal is output for 1s. :

- When initializing.
- When switching a receiving band.
- When calling a preset channel.
- When turning a radio OFF or ON (Radio ON/OFF by the $\overline{\text{INH}}$).

b. In the following cases, mute signal is output :

- During auto up tuning.
- When reaching the band edge during manual up/down tuning or continuous tuning.

c. In the following cases, no mute signal is output :

- In the clock mode.
- When operating [MEMORY], [FAST], [MODE] or [SHIFT] key.
- When writing into a preset channel.
- When calling the same preset channel.

MUTE OUTPUT TIMING AND PLL DATA

PLL : PLL data set timing

IF : IF count start timing

1. When initializing

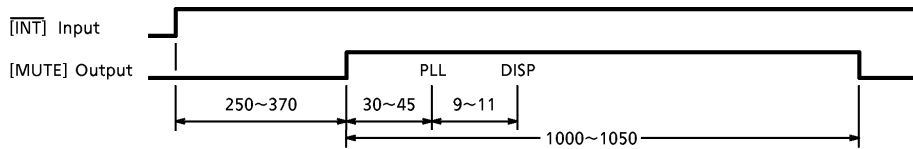

2. When a radio ON/OFF

Radio OFF to ON

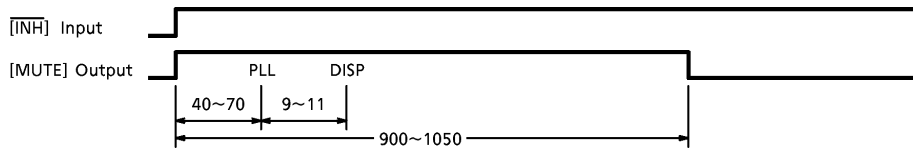

Radio ON to OFF

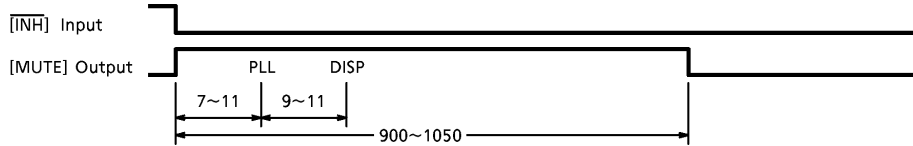

3. Band change (by slide switch)

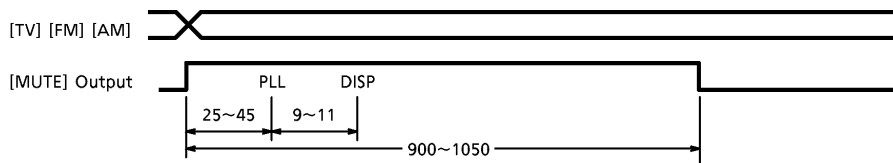

4. Band change (by push switch)

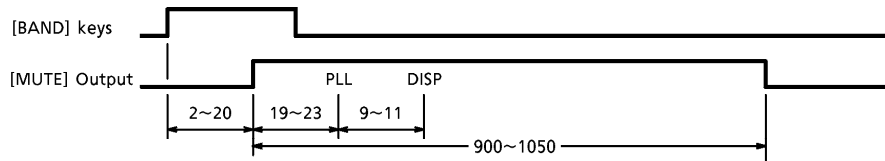

5. When calling a preset memory

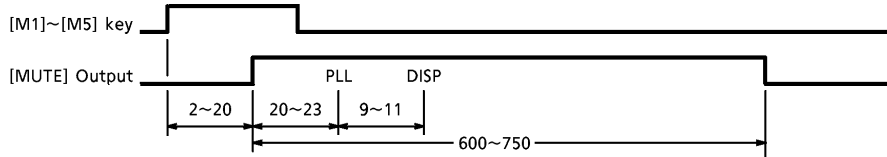

6. Auto seek tuning

narrow : count gate time at narrow accuracy = 4ms (AM) / 1ms (FM)

wide : count gate time at wide accuracy = 16ms (AM) / 4ms (FM)

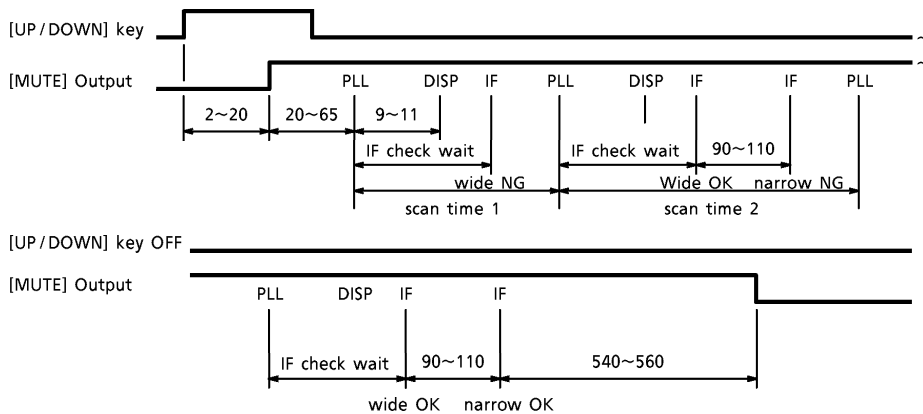

BAND	SCAN TIME 1 [ms]	SCAN TIME 2 [ms]	IF CHECK WAIT [ms]
FM	95~110	190~205	65~85
AM	190~210	285~305	155~175

(Note) Time of SCAN TIME 1 is about 0.5s. wait time when changing from upper limit frequency to lower limit frequency and about 1s. when changing into SW meter band.