

## Optocoupler with Phototransistor Output

### Description

The TCDT1120(G) series consists of a phototransistor optically coupled to a gallium arsenide infrared-emitting diode in a 6-lead plastic dual inline package.

The elements are mounted on one leadframe using a **coplanar technique**, providing a fixed distance between input and output for highest safety requirements.

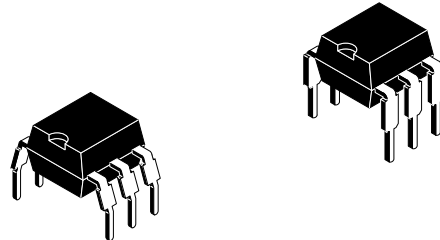

14827

### Applications

Circuits for safe protective separation against electrical shock according to safety class II (reinforced isolation):

- For appl. class I – IV at mains voltage  $\leq 300$  V
- For appl. class I – III at mains voltage  $\leq 600$  V according to VDE 0884, table 2, suitable for:

**Switch-mode power supplies, line receiver, computer peripheral interface, microprocessor system interface.**

### VDE Standards

These couplers perform safety functions according to the following equipment standards:

- **VDE 0884**  
Optocoupler for electrical safety requirements
- **IEC 950/EN 60950**  
Office machines (applied for reinforced isolation for mains voltage  $\leq 400$  V<sub>RMS</sub>)
- **VDE 0804**  
Telecommunication apparatus and data processing
- **IEC 65**  
Safety for mains-operated electronic and related household apparatus

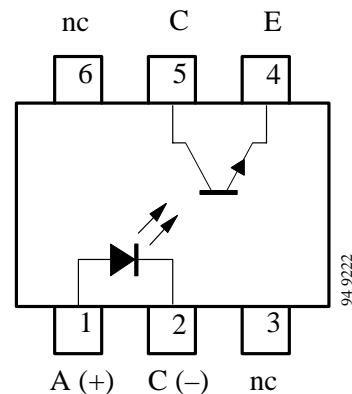

### Order Instruction

Ordering Code	CTR Ranking	Remarks
TCDT1120/ TCDT1120G <sup>1)</sup>	>40%	
TCDT1122/ TCDT1122G <sup>1)</sup>	63 to 125%	
TCDT1123/ TCDT1123G <sup>1)</sup>	100 to 200%	
TCDT1124/ TCDT1124G <sup>1)</sup>	160 to 320%	
<sup>1)</sup> G = Leadform 10.16 mm; G is not market on the body		



## Features

### Approvals:

- **BSI:** BS EN 41003, BS EN 60095 (BS 415), BS EN 60950 (BS 7002), Certificate number 7081 and 7402
- **FIMKO (SETI):** EN 60950, Certificate number 12399
- **Underwriters Laboratory (UL)** 1577 recognized, file number E-76222
- **VDE 0884,** Certificate number 94778

- Rated recurring peak voltage (repetitive)  
 $V_{IORM} = 600 V_{RMS}$
- Creepage current resistance according to VDE 0303/IEC 112  
**Comparative Tracking Index: CTI = 275**
- Thickness through insulation  $\geq 0.75$  mm

### VDE 0884 related features:

- Rated impulse voltage (transient overvoltage)  
 $V_{IOTM} = 6$  kV peak
- Isolation test voltage (partial discharge test voltage)  $V_{pd} = 1.6$  kV
- Rated isolation voltage (RMS includes DC)  
 $V_{IOWM} = 600 V_{RMS}$  (848 V peak)

### General features:

- Isolation materials according to UL94-VO
- Pollution degree 2 (DIN/VDE 0110 resp. IEC 664)
- Climatic classification 55/100/21 (IEC 68 part 1)
- Special construction:  
Therefore, extra low coupling capacity of typical 0.3 pF, high **Common Mode Rejection**
- Low temperature coefficient of CTR
- Base not connected
- CTR offered in 4 groups
- Coupling System A

## Absolute Maximum Ratings

### Input (Emitter)

Parameter	Test Conditions	Symbol	Value	Unit
Reverse voltage		$V_R$	5	V
Forward current		$I_F$	60	mA
Forward surge current	$t_p \leq 10 \mu s$	$I_{FSM}$	3	A
Power dissipation	$T_{amb} \leq 25^\circ C$	$P_V$	100	mW
Junction temperature		$T_j$	125	$^\circ C$

### Output (Detector)

Parameter	Test Conditions	Symbol	Value	Unit
Collector base voltage		$V_{CBO}$	90	V
Collector emitter voltage		$V_{CEO}$	90	V
Emitter collector voltage		$V_{ECO}$	7	V
Collector current		$I_C$	50	mA
Collector peak current	$t_p/T = 0.5, t_p \leq 10$ ms	$I_{CM}$	100	mA
Power dissipation	$T_{amb} \leq 25^\circ C$	$P_V$	150	mW
Junction temperature		$T_j$	125	$^\circ C$

### Coupler

Parameter	Test Conditions	Symbol	Value	Unit
Isolation test voltage (RMS)	$t = 1$ min	$V_{IO}$	3.75	kV
Total power dissipation	$T_{amb} \leq 25^\circ C$	$P_{tot}$	250	mW
Ambient temperature range		$T_{amb}$	-55 to +100	$^\circ C$
Storage temperature range		$T_{stg}$	-55 to +125	$^\circ C$
Soldering temperature	2 mm from case, $t \leq 10$ s	$T_{sd}$	260	$^\circ C$



### Electrical Characteristics ( $T_{amb} = 25^{\circ}\text{C}$ )

#### Input (Emitter)

Parameter	Test Conditions	Symbol	Min.	Typ.	Max.	Unit
Forward voltage	$I_F = 50 \text{ mA}$	$V_F$		1.25	1.6	V
Junction capacitance	$V_R = 0, f = 1 \text{ MHz}$	$C_j$		50		pF

#### Output (Detector)

Parameter	Test Conditions	Symbol	Min.	Typ.	Max.	Unit
Collector base voltage	$I_C = 100 \mu\text{A}$	$V_{CBO}$	90			V
Collector emitter voltage	$I_C = 1 \text{ mA}$	$V_{CEO}$	90			V
Emitter collector voltage	$I_E = 100 \mu\text{A}$	$V_{ECO}$	7			V
Collector emitter cut-off current	$V_{CE} = 20 \text{ V}, I_f = 0$	$I_{CEO}$			150	nA

#### Coupler

Parameter	Test Conditions	Symbol	Min.	Typ.	Max.	Unit
Collector emitter saturation voltage	$I_F = 10 \text{ mA}, I_C = 1 \text{ mA}$	$V_{CEsat}$			0.3	V
Cut-off frequency	$V_{CE} = 5 \text{ V}, I_F = 10 \text{ mA}, R_L = 100 \Omega$	$f_c$		110		kHz
Coupling capacitance	$f = 1 \text{ MHz}$	$C_k$		0.3		pF

#### Current Transfer Ratio (CTR)

Parameter	Test Conditions	Type	Symbol	Min.	Typ.	Max.	Unit
$I_C/I_F$	$V_{CE} = 5 \text{ V}, I_F = 1 \text{ mA}$	TCDT1120(G)	CTR	0.10			
		TCDT1122(G)	CTR	0.15			
		TCDT1123(G)	CTR	0.30			
		TCDT1124(G)	CTR	0.60			
	$V_{CE} = 5 \text{ V}, I_F = 10 \text{ mA}$	TCDT1120(G)	CTR	0.40			
		TCDT1122(G)	CTR	0.63		1.25	
		TCDT1123(G)	CTR	1		2.00	
		TCDT1124(G)	CTR	1.60		3.20	

### Maximum Safety Ratings (according to VDE 0884) see figure 1

This device is used for protective separation against electrical shock only within the maximum safety ratings. This must be ensured by using protective circuits in the applications.

#### Input (Emitter)

Parameters	Test Conditions	Symbol	Value	Unit
Forward current		$I_{si}$	130	mA

#### Output (Detector)

Parameters	Test Conditions	Symbol	Value	Unit
Power dissipation	$T_{amb} \leq 25^\circ\text{C}$	$P_{si}$	265	mW

#### Coupler

Parameters	Test Conditions	Symbol	Value	Unit
Rated impulse voltage		$V_{IOTM}$	6	kV
Safety temperature		$T_{si}$	150	$^\circ\text{C}$

### Insulation Rated Parameters (according to VDE 0884)

Parameter	Test Conditions	Symbol	Min.	Typ.	Max.	Unit
Partial discharge test voltage – Routine test	100%, $t_{test} = 1\text{ s}$	$V_{pd}$	1.6			kV
Partial discharge test voltage – Lot test (sample test)	$t_{Tr} = 60\text{ s}$ , $t_{test} = 10\text{ s}$ , (see figure 2)	$V_{IOTM}$	6			kV
		$V_{pd}$	1.3			kV
Insulation resistance	$V_{IO} = 500\text{ V}$	$R_{IO}$	$10^{12}$			$\Omega$
	$V_{IO} = 500\text{ V}$ , $T_{amb} \leq 100^\circ\text{C}$	$R_{IO}$	$10^{11}$			$\Omega$
	$V_{IO} = 500\text{ V}$ , $T_{amb} \leq 150^\circ\text{C}$ (construction test only)	$R_{IO}$	$10^9$			$\Omega$

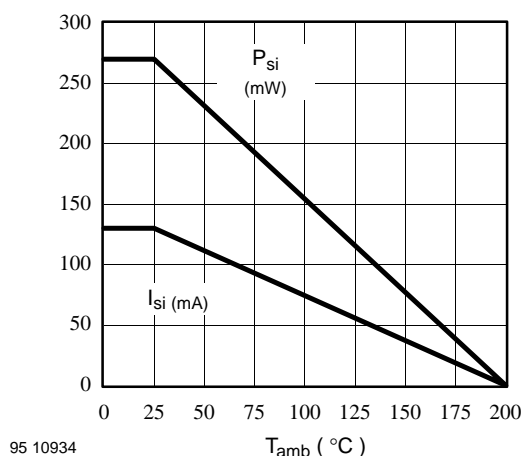

Figure 1. Derating diagram

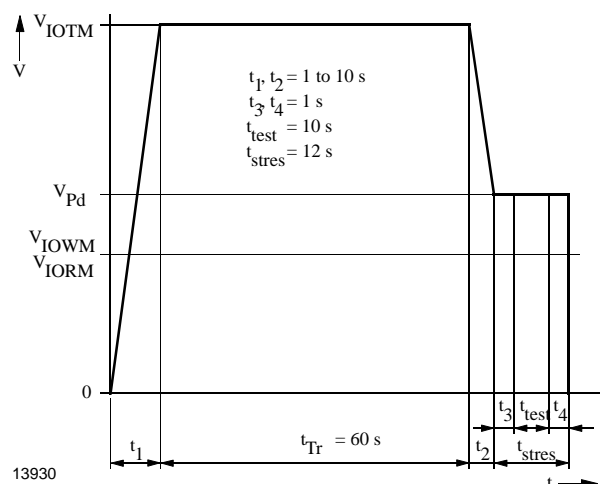

Figure 2. Test pulse diagram for sample test according to DIN VDE 0884

## Switching Characteristics of TCDT1120(G) and TCDT1122(G)

Parameter	Test Conditions	Symbol	Typ.	Unit
Delay time	$V_S = 5\text{ V}$ , $I_C = 10\text{ mA}$ , $R_L = 100\ \Omega$ (see figure 3)	$t_d$	2.5	$\mu\text{s}$
Rise time		$t_r$	3.0	$\mu\text{s}$
Fall time		$t_f$	3.7	$\mu\text{s}$
Storage time		$t_s$	0.3	$\mu\text{s}$
Turn-on time		$t_{on}$	5.5	$\mu\text{s}$
Turn-off time		$t_{off}$	4.0	$\mu\text{s}$
Turn-on time	$V_S = 5\text{ V}$ , $I_C = 10\text{ mA}$ , $R_L = 1\text{ k}\Omega$ (see figure 4)	$t_{on}$	16.5	$\mu\text{s}$
Turn-off time		$t_{off}$	22.5	$\mu\text{s}$

## Switching Characteristics of TCDT1123(G)

Parameter	Test Conditions	Symbol	Typ.	Unit
Delay time	$V_S = 5\text{ V}$ , $I_C = 10\text{ mA}$ , $R_L = 100\ \Omega$ (see figure 3)	$t_d$	2.8	$\mu\text{s}$
Rise time		$t_r$	4.2	$\mu\text{s}$
Fall time		$t_f$	4.7	$\mu\text{s}$
Storage time		$t_s$	0.3	$\mu\text{s}$
Turn-on time		$t_{on}$	7.0	$\mu\text{s}$
Turn-off time		$t_{off}$	5.0	$\mu\text{s}$
Turn-on time	$V_S = 5\text{ V}$ , $I_C = 10\text{ mA}$ , $R_L = 1\text{ k}\Omega$ (see figure 4)	$t_{on}$	21.0	$\mu\text{s}$
Turn-off time		$t_{off}$	37.5	$\mu\text{s}$

## Switching Characteristics of TCDT1124(G)

Parameter	Test Conditions	Symbol	Typ.	Unit
Delay time	$V_S = 5\text{ V}$ , $I_C = 10\text{ mA}$ , $R_L = 100\ \Omega$ (see figure 3)	$t_d$	2.0	$\mu\text{s}$
Rise time		$t_r$	4.0	$\mu\text{s}$
Fall time		$t_f$	4.7	$\mu\text{s}$
Storage time		$t_s$	0.3	$\mu\text{s}$
Turn-on time		$t_{on}$	6.0	$\mu\text{s}$
Turn-off time		$t_{off}$	5.0	$\mu\text{s}$
Turn-on time	$V_S = 5\text{ V}$ , $I_C = 10\text{ mA}$ , $R_L = 1\text{ k}\Omega$ (see figure 4)	$t_{on}$	20.0	$\mu\text{s}$
Turn-off time		$t_{off}$	50.0	$\mu\text{s}$

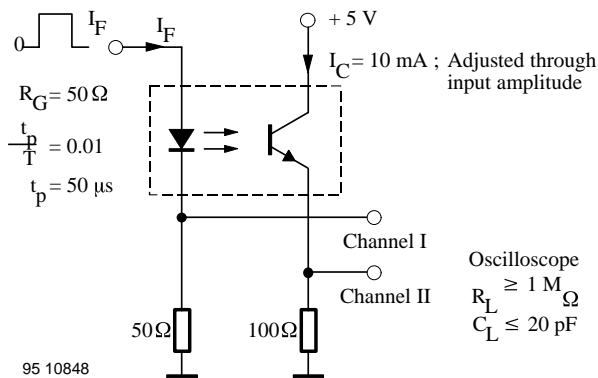

Figure 3. Test circuit, non-saturated operation

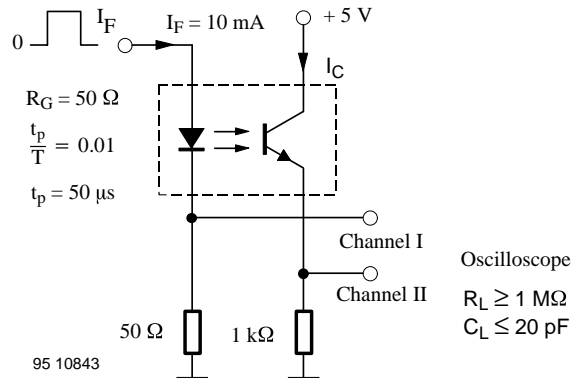

Figure 4. Test circuit, saturated operation

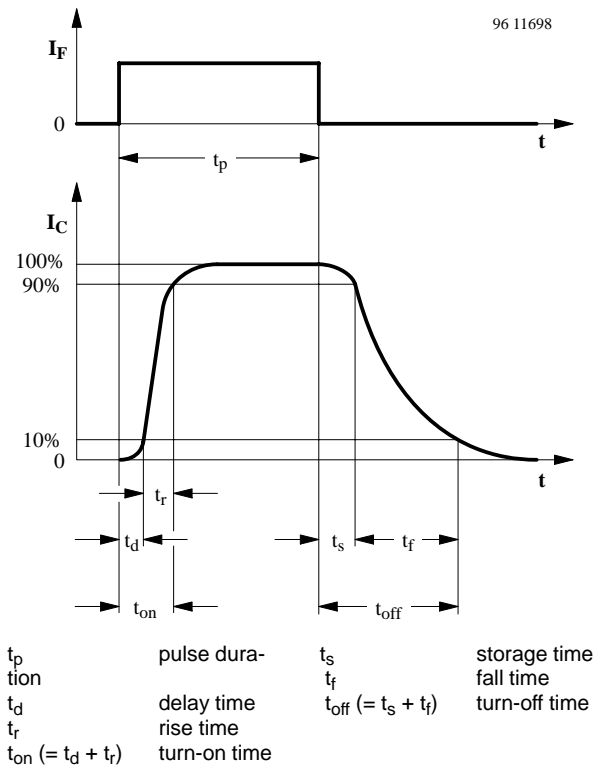

Figure 5. Switching times

## Typical Characteristics ( $T_{amb} = 25^\circ\text{C}$ , unless otherwise specified)

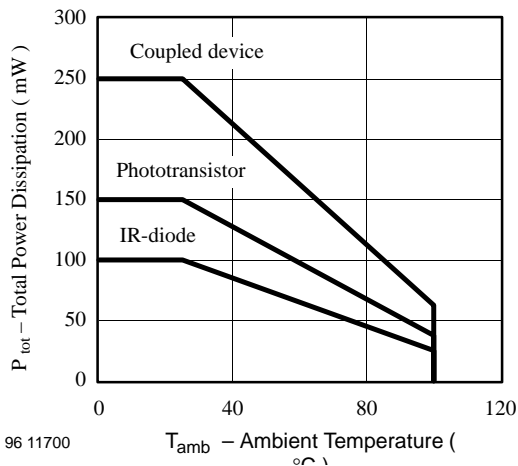

Figure 6. Total Power Dissipation vs. Ambient Temperature

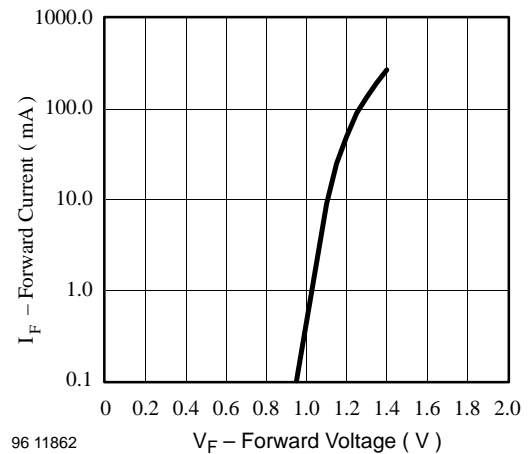

Figure 7. Forward Current vs. Forward Voltage

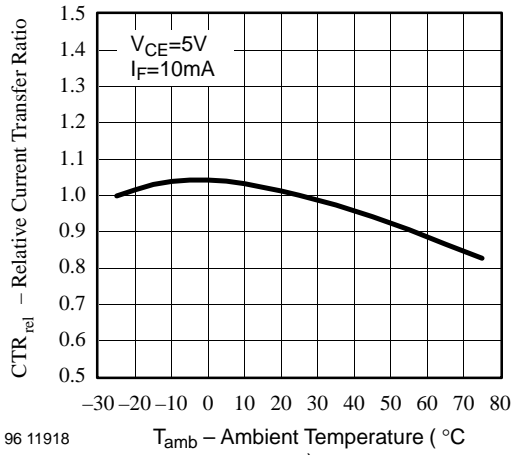

Figure 8. Relative Current Transfer Ratio vs. Ambient Temperature

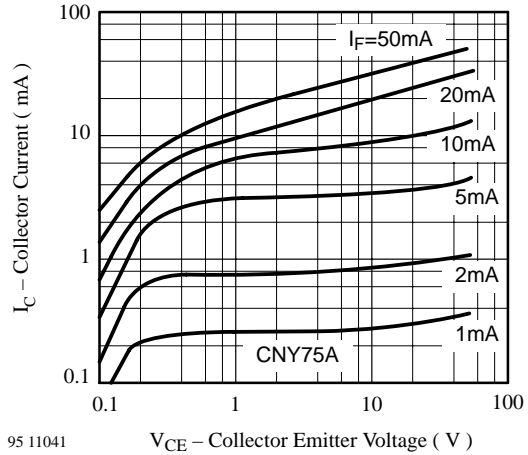

Figure 11. Collector Current vs. Collector Emitter Voltage

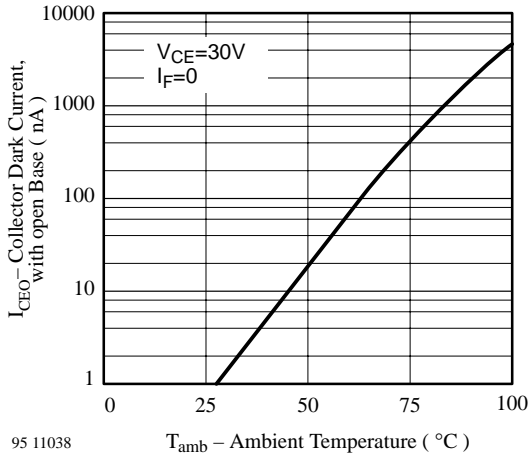

Figure 9. Collector Dark Current vs. Ambient Temperature

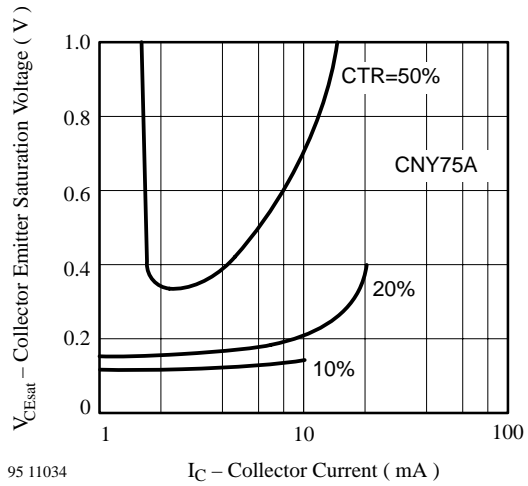

Figure 12. Collector Emitter Saturation Voltage vs. Collector Current

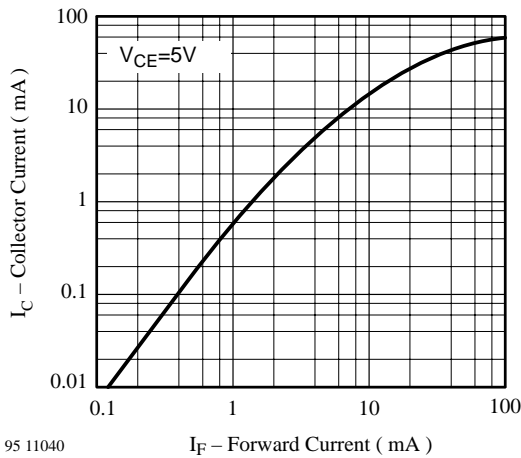

Figure 10. Collector Current vs. Forward Current

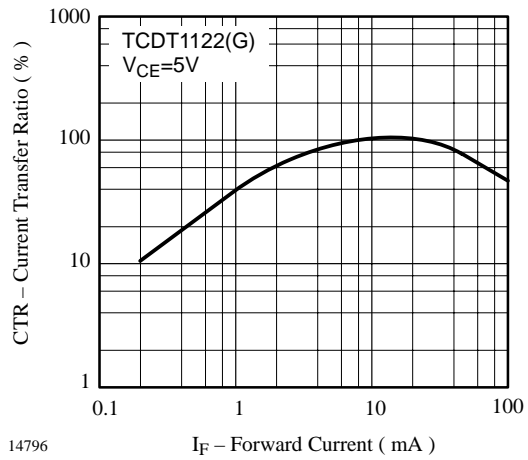

Figure 13. Current Transfer Ratio vs. Forward Current

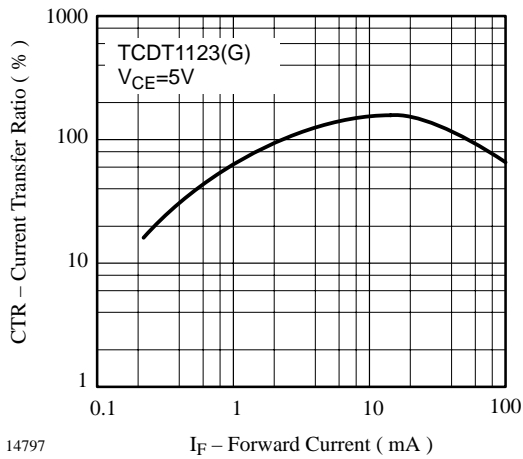

Figure 14. Current Transfer Ratio vs. Forward Current

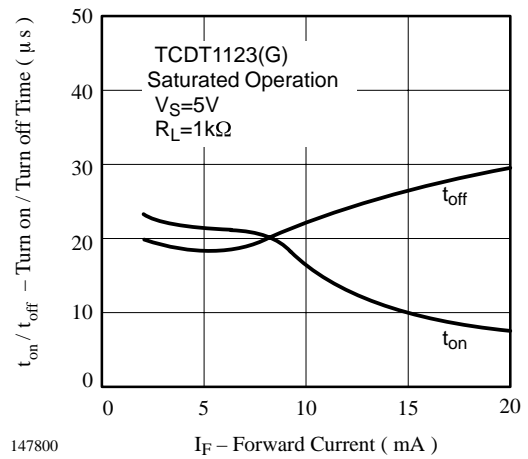

Figure 17. Turn on / off Time vs. Forward Current

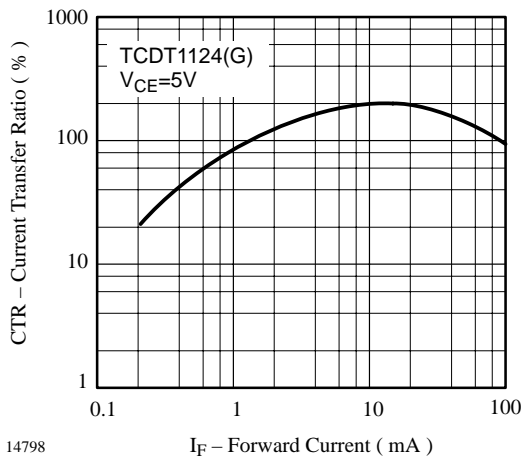

Figure 15. Current Transfer Ratio vs. Forward Current

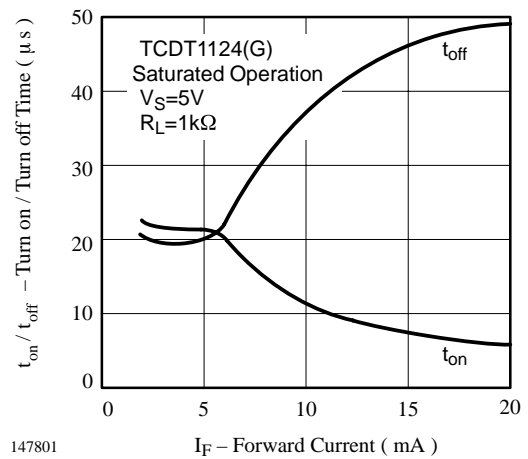

Figure 18. Turn on / off Time vs. Forward Current

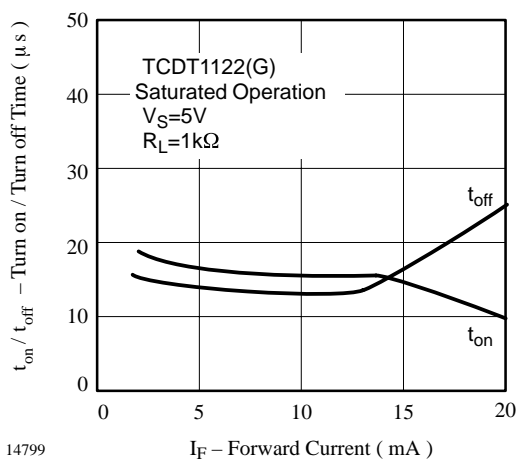

Figure 16. Turn on / off Time vs. Forward Current

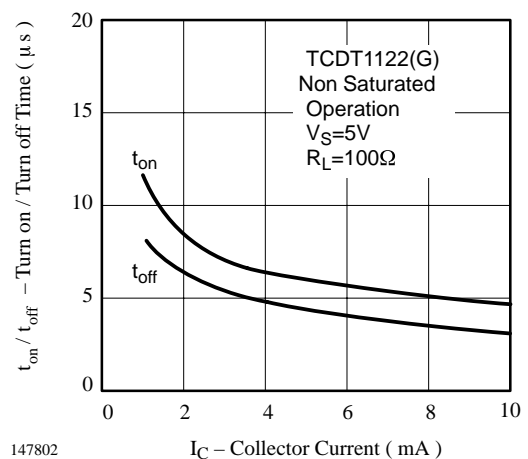
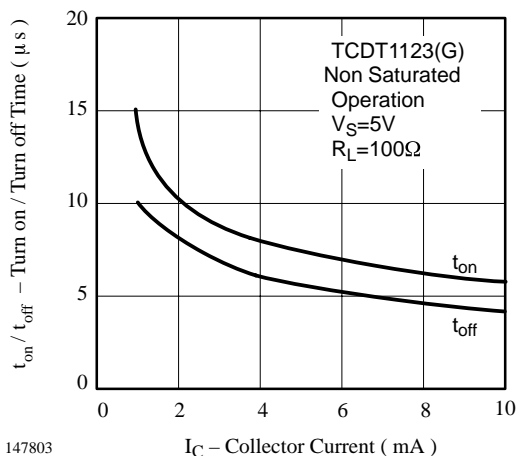

Figure 19. Turn on / off Time vs. Collector Current





147803

Figure 20. Turn on / off Time vs. Collector Current

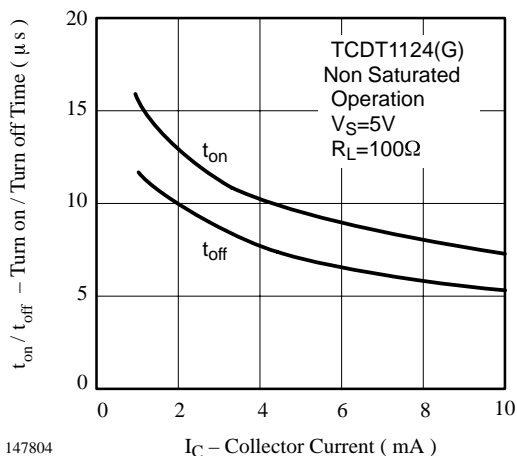

147804

Figure 21. Turn on / off Time vs. Collector Current

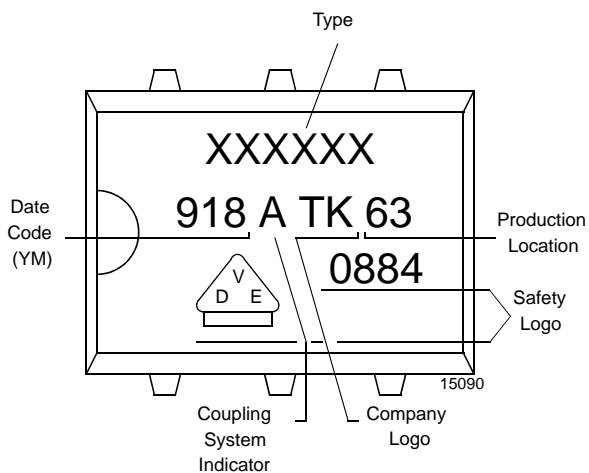
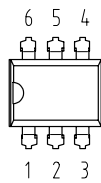
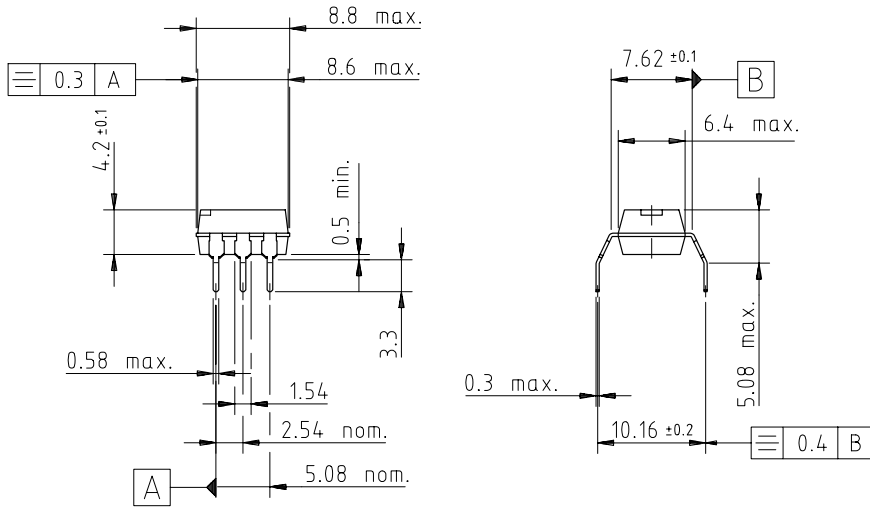

Figure 22. Marking example

### Dimensions of TCDT112.G in mm



weight: ca. 0.50 g  
 creepage distance:  $\cong 8$  mm  
 air path:  $\cong 8$  mm

after mounting on PC board

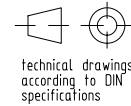

14771

### Dimensions of TCDT112. in mm

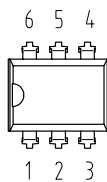
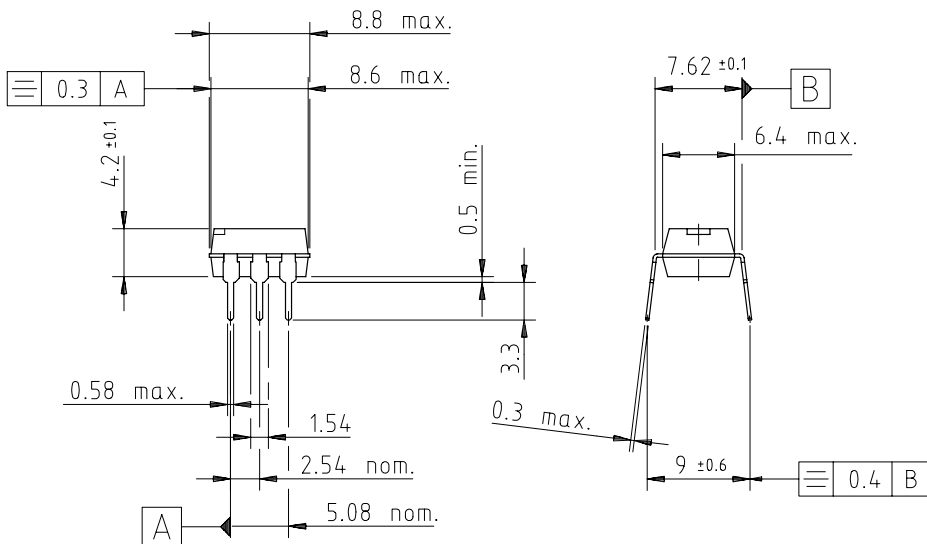

weight: 0.50 g  
 creepage distance:  $\cong 6$  mm  
 air path:  $\cong 6$  mm

after mounting on PC board

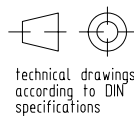

14770