

# SPEC

Spec No.	TQ3C-8EAF0-E1DDP48-00
Date	May 22, 2008

## **TYPE : TCG057VGLBA-G20**

< 5.7 inch VGA transmissive color TFT with LED backlight,  
Constant current circuit for LED backlight >

### CONTENTS

1. Application
2. Construction and outline
3. Mechanical specifications
4. Absolute maximum ratings
5. Electrical characteristics
6. Optical characteristics
7. Interface signals
8. Input timing characteristics
9. Backlight characteristics
10. Lot number identification
11. Warranty
12. Precautions for use
13. Reliability test data
14. Outline drawing



KYOCERA CORPORATION  
KAGOSHIMA HAYATO PLANT  
LCD DIVISION

This specification is subject to change without notice.  
Consult Kyocera before ordering.

Original Issue Date	Designed by: Engineering dept.			Confirmed by: QA dept.	
	Prepared	Checked	Approved	Checked	Approved
May 22, 2008	<i>D. Ajisaka</i>	<i>T. Johno</i>	<i>Y. Matsumoto</i>	<i>J. Sakaguchi</i>	<i>T. Ito</i>

Spec No. TQ3C-8EAF0-E1DDP48-00	Part No. TCG057VGLBA-G20	Page -
-----------------------------------	-----------------------------	-----------

---

## **Warning**

1. This Kyocera LCD module has been specifically designed for use only in electronic devices and industrial machines in the area of audio control, office automation, industrial control home appliances, etc. The module should not be used in applications where the highest level of safety and reliability are required and module failure or malfunction of such module results in physical harm or loss of life, as well as enormous damage or loss. Such fields of applications include, without limitation, medical, aerospace, communications infrastructure, atomic energy control. Kyocera expressly disclaims any and all liability resulting in any way to the use of the module in such applications.
  
2. Customer agrees to indemnify, defend and hold Kyocera harmless from and against any and all actions, claims, damages, liabilities, awards, costs, and expenses, including legal expenses, resulting from or arising out of Customer's use, or sale for use, or Kyocera modules in applications.

## **Caution**

1. Kyocera shall have the right, which Customer hereby acknowledges, to immediately scrap or destroy tooling for Kyocera modules for which no Purchase Orders have been received from the Customer in a two-year period.

Spec No. TQ3C-8EAF0-E1DDP48-00	Part No. TCG057VGLBA-G20	Page -
-----------------------------------	-----------------------------	-----------

**Revision record**

Date		Designed by : Engineering dept.			Confirmed by : QA dept.	
		Prepared	Checked	Approved	Checked	Approved
Rev.No.	Date	Page	Descriptions			

## 1. Application

This document defines the specification of TCG057VGLBA-G20. (RoHS Compliant)

## 2. Construction and outline

LCD	: Transmissive color dot matrix type TFT
Backlight system	: LED
Polarizer	: Glare treatment
Additional circuit	: Timing controller, Power supply (3.3V input) (with constant current circuit for LED Backlight)

## 3. Mechanical specifications

Item	Specification	Unit
Outline dimensions	127.2 (W) × 100.4 (H) × 5.7 (D)	mm
Active area	115.2 (W) × 86.4 (H) (14.4cm / 5.7 inch (Diagonal))	mm
Dot format	640×(B,G,R) (W) × 480 (H)	dot
Dot pitch	0.06 (W) × 0.18 (H)	mm
Base color *1	Normally White	-
Mass	110	g

\*1 Due to the characteristics of the LCD material, the color varies with environmental temperature.

## 4. Absolute maximum ratings

### 4-1. Electrical absolute maximum ratings

Item	Symbol	Min.	Max.	Unit
Supply voltage for logic	V <sub>DD</sub>	0	4.0	V
Input signal voltage *1	V <sub>IN</sub>	-0.3	6.0	V
Supply voltage for backlight	V <sub>INB</sub>	0	6.0	V
Backlight ON-OFF	BLEN	0	V <sub>INB</sub>	V
Brightness adjust voltage	VBRT	0	V <sub>INB</sub>	V

\*1 Input signal : CK, R0 ~ R5, G0 ~ G5, B0 ~ B5, H<sub>SYNC</sub>, V<sub>SYNC</sub>, ENAB, R/L, U/D

### 4-2. Environmental absolute maximum ratings

Item	Symbol	Min.	Max.	Unit
Operating temperature *1	T <sub>OP</sub>	-20	70	°C
Storage temperature *2	T <sub>STO</sub>	-30	80	°C
Operating humidity *3	H <sub>OP</sub>	10	*4	%RH
Storage humidity *3	H <sub>STO</sub>	10	*4	%RH
Vibration	-	*5	*5	-
Shock	-	*6	*6	-

\*1 Operating temperature means a temperature which operation shall be guaranteed. Since display performance is evaluated at 25°C, another temperature range should be confirmed.

\*2 Temp. = -30°C < 48h , Temp. = 80°C < 168h

Store LCD panels at normal temperature/humidity. Keep them free from vibration and shock. An LCD panel that is kept at a low or a high temperature for a long time can be defective due to other conditions, even if the low or high temperature satisfies the standard. (Please refer to “Precautions for Use” for details.)

\*3 Non-condensing

\*4 Temp. 40°C, 85%RH Max.

Temp. > 40°C, Absolute humidity shall be less than 85%RH at 40°C.

\*5

Frequency	10 ~ 55 Hz	Acceleration value (0.3 ~ 9 m/s <sup>2</sup> )
Vibration width	0.15mm	
Interval	10-55-10 Hz	1 minutes

2 hours in each direction X, Y, Z (6 hours total)  
EIAJ ED-2531

\*6 Acceleration: 490 m/s<sup>2</sup>, Pulse width: 11 ms

3 times in each direction: ±X, ±Y, ±Z

EIAJ ED-2531

## 5. Electrical characteristics

Temp. = -20 ~ 70°C

Item	Symbol	Condition	Min.	Typ.	Max.	Unit
Supply voltage for logic *1	V <sub>DD</sub>	-	3.0	3.3	3.6	V
Current consumption for logic	I <sub>DD</sub>	*2	-	170	220	mA
Permissible input ripple voltage	V <sub>RP</sub>	-	-	-	100	mVp-p
Input signal voltage *3	V <sub>IL</sub>	"Low" level	0	-	0.3V <sub>DD</sub>	V
	V <sub>IH</sub>	"High" level	0.7V <sub>DD</sub>	-	V <sub>DD</sub>	V

\*1 V<sub>DD</sub>-turn-on conditions

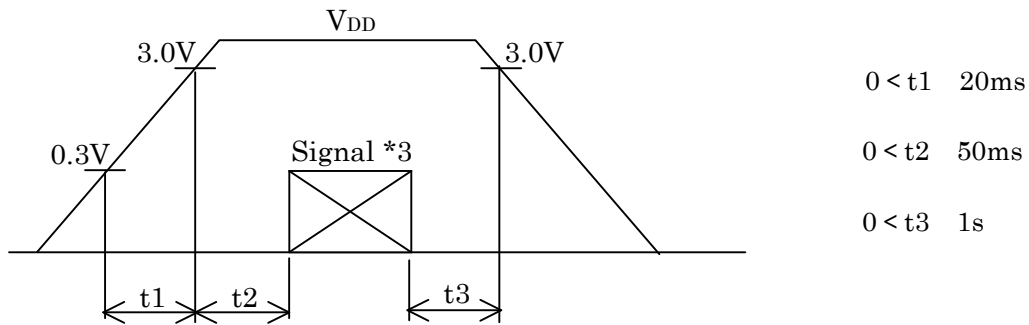

\*2 Display pattern:

V<sub>DD</sub> = 3.3V, Temp. = 25°C

123 456 789 • • • • • 1918 1919 1920(dot)  
 1  
 2  
 3  
 :  
 :  
 :  
 479  
 480  
 (dot)

\*3 Input signal : CK, R0 ~ R5, G0 ~ G5, B0 ~ B5, H<sub>SYNC</sub>, V<sub>SYNC</sub>, ENAB, R/L, U/D

## 6. Optical characteristics

Measuring spot = 6.0mm, Temp. = 25°C

Item	Symbol	Condition	Min.	Typ.	Max.	Unit	
Response time	Rise	$\tau_r$	= =0°	-	10	-	ms
	Down	$\tau_d$	= =0°	-	25	-	ms
Viewing angle range View direction : 6 o'clock (Gray inversion)	UPPER	CR 5	= =0°	-	80	-	deg.
	LOWER			-	80	-	
	LEFT			-	80	-	deg.
	$\phi$ RIGHT			-	80	-	
Contrast ratio	CR	= =0°	300	500	-	-	
Brightness	L	IF=15mA/Line	175	250	-	cd/m <sup>2</sup>	
Chromaticity coordinates	Red	x	= =0°	0.56	0.61	0.66	-
		y		0.32	0.37	0.42	
	Green	x	= =0°	0.29	0.34	0.39	
		y		0.52	0.57	0.62	
	Blue	x	= =0°	0.09	0.14	0.19	
		y		0.06	0.11	0.16	
	White	x	= =0°	0.27	0.32	0.37	
		y		0.29	0.34	0.39	

### 6-1. Definition of contrast ratio

$$CR(\text{Contrast ratio}) = \frac{\text{Brightness with all pixels "White"}}{\text{Brightness with all pixels "Black"}}$$

### 6-2. Definition of response time

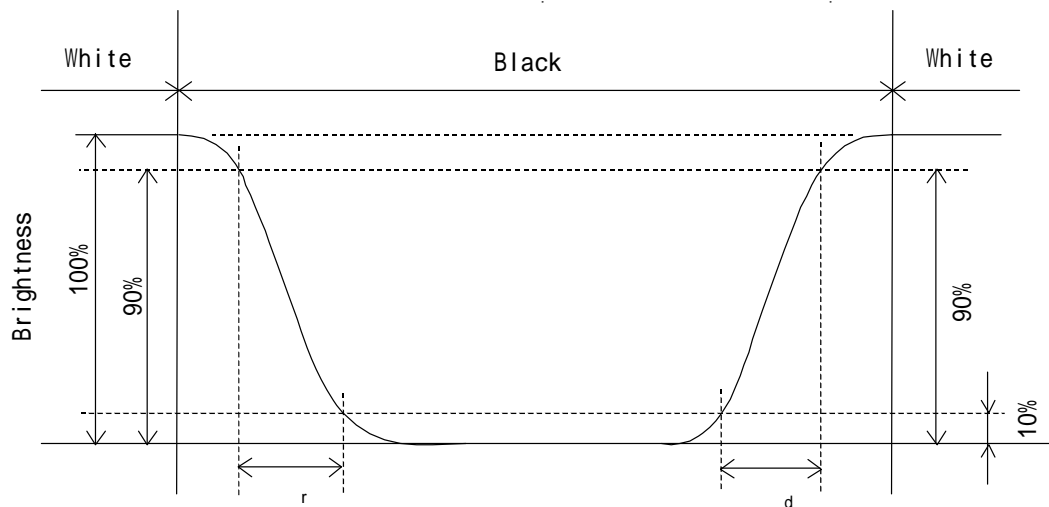

6-3. Definition of viewing angle

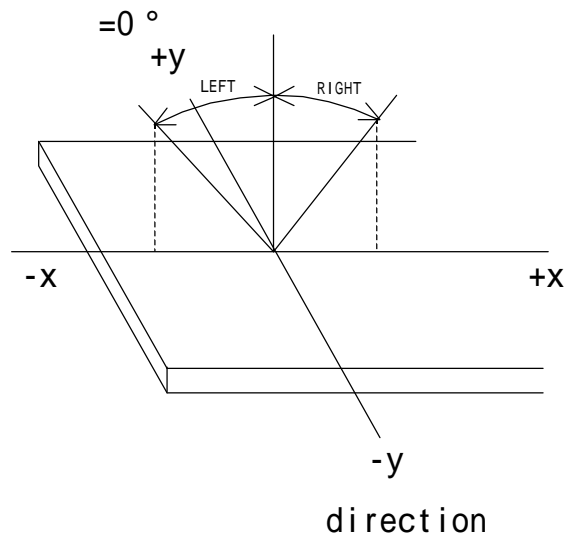
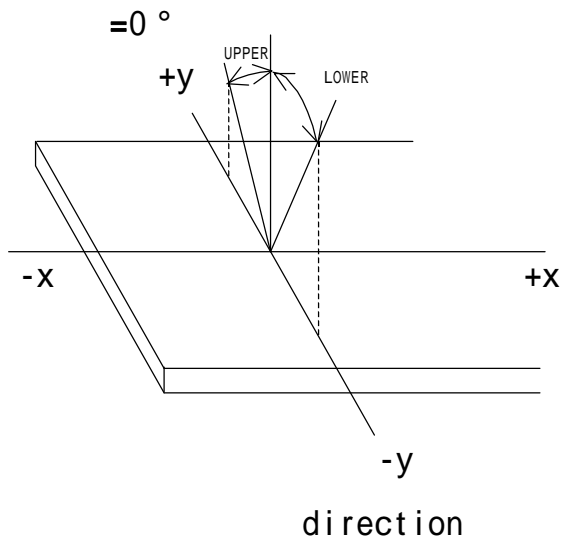

6-4. Brightness measuring points

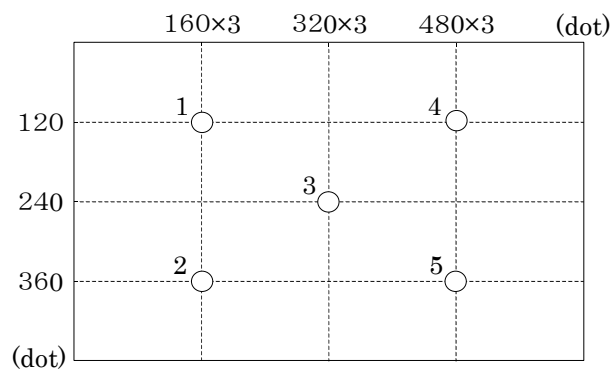

- 1) Rating is defined on the average in the viewing area.
- 2) Measured 30 minutes after the LED is powered on. (Ambient temp. = 25°C)



## 7. Interface signals

No.	Symbol	Description	I/O	Note
1	GND	GND	-	
2	CK	Clock signal for sampling each data signal	I	
3	H <sub>SYNC</sub>	Horizontal synchronous signal (negative)	I	
4	V <sub>SYNC</sub>	Vertical synchronous signal (negative)	I	
5	GND	GND	-	
6	R0	RED data signal (LSB)	I	
7	R1	RED data signal	I	
8	R2	RED data signal	I	
9	R3	RED data signal	I	
10	R4	RED data signal	I	
11	R5	RED data signal (MSB)	I	
12	GND	GND	-	
13	G0	GREEN data signal (LSB)	I	
14	G1	GREEN data signal	I	
15	G2	GREEN data signal	I	
16	G3	GREEN data signal	I	
17	G4	GREEN data signal	I	
18	G5	GREEN data signal (MSB)	I	
19	GND	GND	-	
20	B0	BLUE data signal (LSB)	I	
21	B1	BLUE data signal	I	
22	B2	BLUE data signal	I	
23	B3	BLUE data signal	I	
24	B4	BLUE data signal	I	
25	B5	BLUE data signal (MSB)	I	
26	GND	GND	-	
27	ENAB	Signal to settle the horizontal display position (positive)	I	*1
28	V <sub>DD</sub>	3.3V power supply	-	
29	V <sub>DD</sub>	3.3V power supply	-	
30	R/L	Horizontal display mode select signal L : Normal , H : Left / Right reverse mode	I	*2
31	U/D	Vertical display mode select signal H : Normal , L : Up / Down reverse mode	I	
32	NC	No connect	-	
33	V <sub>INB</sub>	Power supply for LED backlight	-	
34	V <sub>INB</sub>	Power supply for LED backlight	-	
35	V <sub>INB</sub>	Power supply for LED backlight	-	
36	BLEN	Backlight ON-OFF (H:ON, L:OFF)	-	
37	VBRT	Brightness adjust voltage	-	
38	GNDB	GND for LED backlight	-	
39	GNDB	GND for LED backlight	-	
40	GNDB	GND for LED backlight	-	

LCD connector : IMSA-9681S-40A-GF (IRISO)  
Recommended matching FFC or FPC : 0.5mm pitch

\*1 The horizontal display start timing is settled in accordance with a rising timing of ENAB signal.  
In case ENAB is fixed "Low", the horizontal start timing is determined.  
Don't keep ENAB "High" during operation.

\*2



R/L = L  
U/D = H



R/L = H  
U/D = H



R/L = L  
U/D = L



R/L = H  
U/D = L

## 8. Input timing characteristics

### 8-1. Timing characteristics

Item		Symbol	Min	Typ	Max	Unit	Note
Clock	Frequency	1/Tc	22.66	25.18	27.69	MHz	
	Duty ratio	Tch/Tc	40	50	60	%	
Data	Set up time	Tds	10	-	-	ns	
	Hold time	Tdh	10	-	-	ns	
Horizontal sync. signal	Cycle	TH	30.0	31.8	-	μs	
			770	800	850	clock	
	Pulse width	THp	5	30	-	clock	
	Set up time	THs	10	-	-	ns	
	Hold time	THh	10	-	-	ns	
Vertical sync. signal	Cycle	TV	515	525	535	line	ENAB=L
			515	525	560	line	with ENAB
	Pulse width	TVp	1	3	5	line	
	Set up time	TVs	10	-	-	ns	
	Hold time	TVh	10	-	-	ns	
Enable signal (ENAB)	Pulse width	TEp	640			clock	
	Set up time	TEs	10	-	-	ns	
	Hold time	TEh	10	-	-	ns	
H <sub>SYNC</sub> - Enable signal phase difference		THE	112	144	175	clock	
H <sub>SYNC</sub> - V <sub>SYNC</sub> signal phase difference		THV	0	-	4	clock	ENAB=L
			10	-	-	ns	with ENAB
Vertical sync. signal start position		TVE	2	35	76	line	
Horizontal display period		THd	640			clock	
Vertical display period		TVd	480			line	

\*When ENAB is fixed at "Low", the horizontal display starts from the data of C144 (clock) as shown in 8-3.

\*When ENAB is fixed at "Low", the vertical sync. signal start position is 35 (line) as shown in 8-3.

\*In case of lower frequency, the deterioration of the display quality, flicker etc., may occur.

### 8-2. Input Data Signals and Display position on the screen

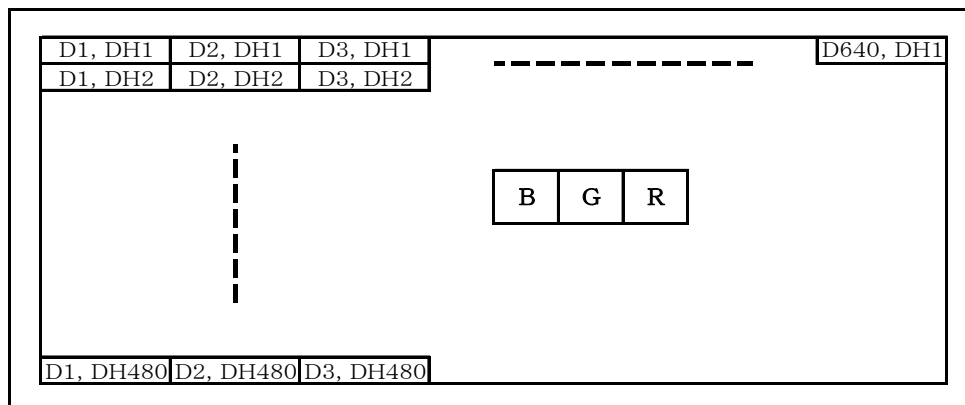

### 8-3. Input timing characteristics

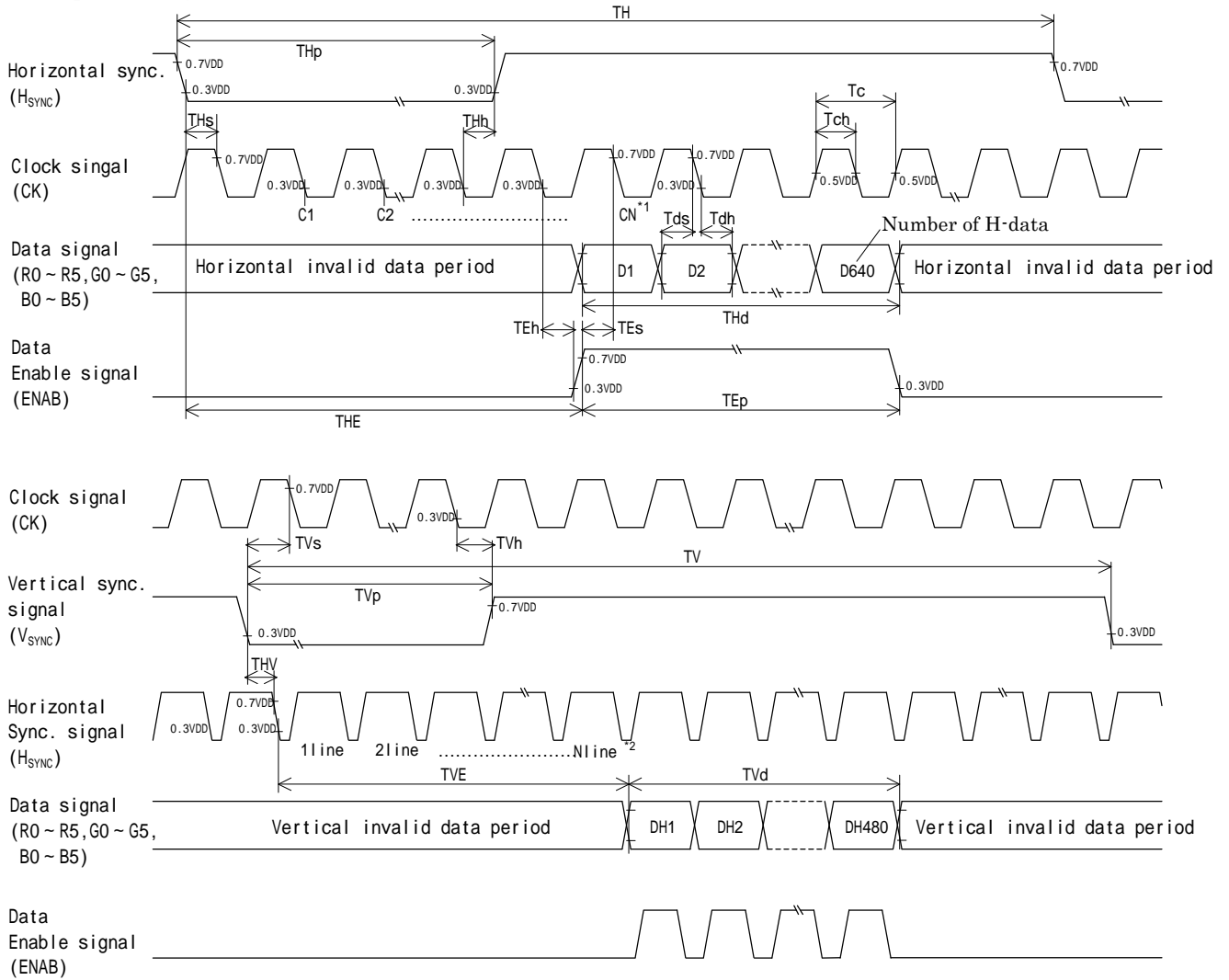

\*1 When ENAB is fixed at "Low", the horizontal display starts from the data of C144 (clock).

\*2 When ENAB is fixed at "Low", the vertical sync. signal start position is 35 (line).

## 9. Backlight characteristics

Temp.=25

Item	Symbol	Min.	Typ.	Max.	Unit	Note
Supply voltage	V <sub>INB</sub>	3.0	-	5.5	V	Ta=-20 ~ 70°C
ON-OFF (H)	BLEN	0.8V <sub>INB</sub>	-	V <sub>INB</sub>	V	Ta=-20 ~ 70°C
ON-OFF (L)		0	-	0.2V <sub>INB</sub>	V	Ta=-20 ~ 70°C
LED forward current *1, *2	I <sub>F</sub>	14	15	16	mA	VBRT=0 ~ 1.4V
		2.8	3.0	3.2		VBRT=2.8V
Supply current	I <sub>INB</sub>	-	440	570	mA	V <sub>INB</sub> =3.3V, I <sub>F</sub> =15mA
		-	280	360	mA	V <sub>INB</sub> =5.0V, I <sub>F</sub> =15mA
Operating life time *3, *4	T	-	40,000	-	h	I <sub>F</sub> =15mA, Ta=25

\*1 For each "LED"

\*2 An input current below 5.0mA may reduce the brightness uniformity of the LED backlight.

This is because the amount of light from each LED chip is different. Therefore, please evaluate carefully before finalizing the input current.

\*3 When brightness decrease 50% of initial brightness.

\*4 Life time is estimated data. (Condition : I<sub>F</sub>=15mA, Ta=25 in chamber)

\* When you start-up, please charge in sequence of V<sub>INB</sub>->BLEN, or VBRT.

When you shut-down, please stop in sequence of BLEN and/or VBRT->V<sub>INB</sub>.

\* Please do not connect the other than our backlight to this output connector on the PCB.

\* In case V<sub>DD</sub> and V<sub>INB</sub> are supplied by a single power source, V<sub>DD</sub> & V<sub>INB</sub>, and GND are connected directly and separately from the output on the power source. If the common wire are used for V<sub>DD</sub> & V<sub>INB</sub>, and for GND, and are split near the PCB, and connect to each LCD driving circuit and backlight driving circuit, a flicker might be occurred due to a ripple between the both circuit.

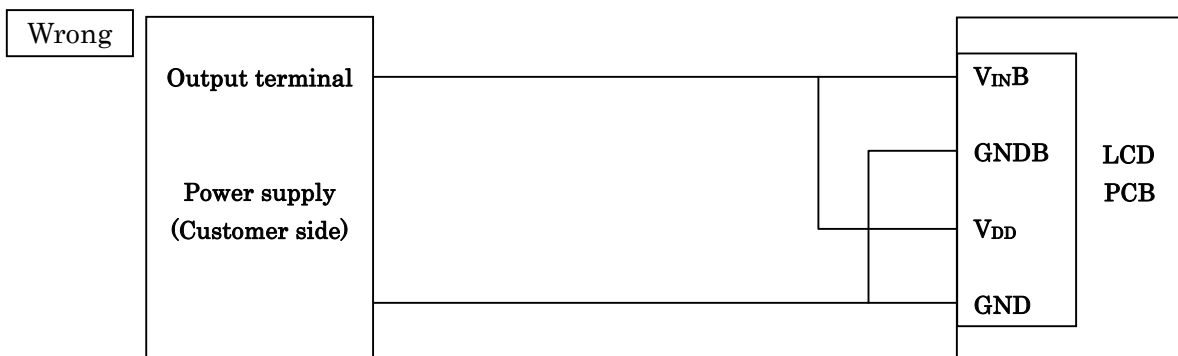
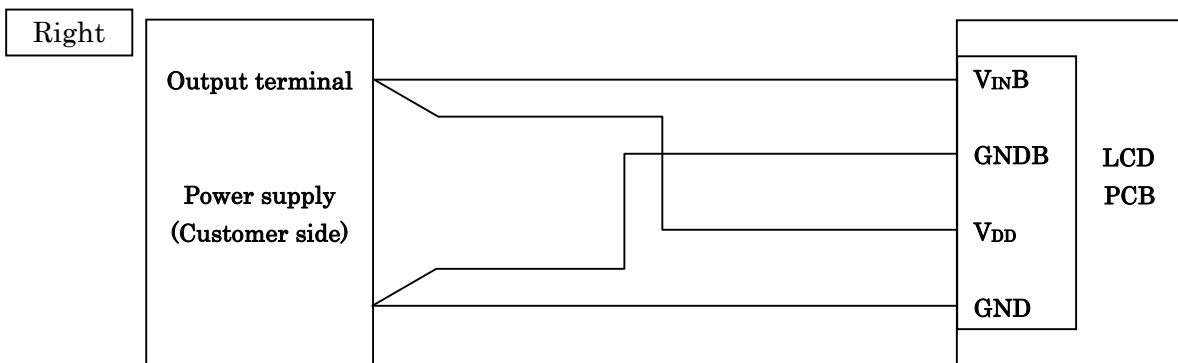

\* VBRT-IF characteristics

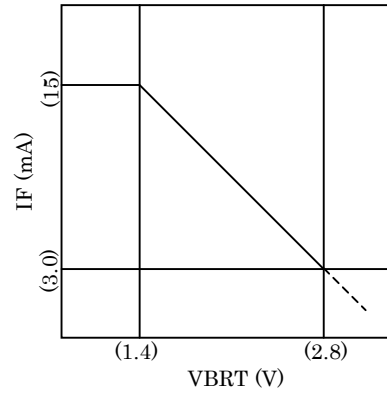

## 10. Lot number identification

The lot number shall be indicated on the back of the backlight case of each LCD.

TCG057VGLBA-G20 - □□ - □□ - □ MADE IN □□□□□

↓ ↓   ↓   ↓   ↓   ↓  
 1 2   3   4   5

No1. - No5. above indicate

1. Year code
2. Month code
3. Date
4. Version Number
5. Country of origin (Japan or China)

Year	2008	2009	2010	2011	2012	2013
Code	8	9	0	1	2	3

Month	Jan.	Feb.	Mar.	Apr.	May	Jun.
Code	1	2	3	4	5	6

Month	Jul.	Aug.	Sep.	Oct.	Nov.	Dec.
Code	7	8	9	X	Y	Z

## 11. Warranty

### 11-1. Incoming inspection

Please inspect the LCD within one month after your receipt.

### 11-2. Production warranty

Kyocera warrants its LCD's for a period of 12 months from the ship date. Kyocera shall, by mutual agreement, replace or re-work defective LCD's that are shown to be Kyocera's responsibility.

Spec No.	Part No.	Page
TQ3C-8EAF0-E1DDP48-00	TCG057VGLBA-G20	13

## 12. Precautions for use

### 12-1. Installation of the LCD

- 1) A transparent protection plate shall be added to protect the LCD and its polarizer.
- 2) The LCD shall be installed so that there is no pressure on the LSI chips.
- 3) The LCD shall be installed flat, without twisting or bending.
- 4) A transparent protection sheet is attached to the polarizer. Please remove the protection film slowly before use, paying attention to static electricity.

### 12-2. Static electricity

- 1) Since CMOS ICs are mounted directly onto the LCD glass, protection from static electricity is required.
- 2) Workers should use body grounding. Operator should wear ground straps.

### 12-3. LCD operation

- 1) The LCD shall be operated within the limits specified. Operation at values outside of these limits may shorten life, and/or harm display images.

### 12-4. Storage

- 1) The LCD shall be stored within the temperature and humidity limits specified.  
Store in a dark area, and protect the LCD from direct sunlight or fluorescent light.
- 2) Always store the LCD so that it is free from external pressure onto it.

### 12-5. Usage

- 1) **DO NOT** store in a high humidity environment for extended periods. Polarizer degradation bubbles, and/or peeling off of the polarizer may result.
- 2) The front polarizer is easily scratched or damaged. Prevent touching it with any hard material, and from being pushed or rubbed.
- 3) The LCD screen may be cleaned by wiping the screen surface with a soft cloth or cotton pad using a little Ethanol.
- 4) Water may cause damage or discoloration of the polarizer. Clean condensation or moisture from any source immediately.
- 5) Always keep the LCD free from condensation during testing. Condensation may permanently spot or stain the polarizer.
- 6) Do not disassemble LCD module because it will result in damage.
- 7) This Kyocera LCD module has been specifically designed for use in general electronic devices, but not for use in a special environment such as usage in an active gas. Hence, when the LCD is supposed to be used in a special environment, evaluate the LCD thoroughly beforehand and do not expose the LCD to chemicals such as an active gas.
- 8) Please do not use solid-base image pattern for long hours because a temporary afterimage may appear. We recommend using screen saver etc. in cases where a solid-base image pattern must be used.
- 9) Liquid crystal may leak when the module is broken. Be careful not to let the fluid go into your eyes and mouth. In the case the fluid touches your body; rinse it off right away with water and soap.



### 13. Reliability test data

Test item	Test condition	Test time	Judgement
High temp. atmosphere	80°C	240h	Display function : No defect Display quality : No defect Current consumption : No defect
Low temp. atmosphere	-30°C	240h	Display function : No defect Display quality : No defect Current consumption : No defect
High temp. humidity atmosphere	40°C 90% RH	240h	Display function : No defect Display quality : No defect Current consumption : No defect
Temp. cycle	-30°C 0.5h R.T. 0.5h 80°C 0.5h	10cycles	Display function : No defect Display quality : No defect Current consumption : No defect
High temp. operation	70°C	500h	Display function : No defect Display quality : No defect Current consumption : No defect

\* Each test item uses a test LCD only once. The tested LCD is not used in any other tests.

\* The LCD is tested in circumstances in which there is no condensation.

\* The reliability test is not an out-going inspection.

\* The result of the reliability test is for your reference purpose only.

The reliability test is conducted only to examine the LCD's capability.

No	Description	Drawn	Checked	Checked	Approved
△	·Add DETAIL B.	'07.12.01 倉元	'07.12.02 鶴崎		'07.12.03 南

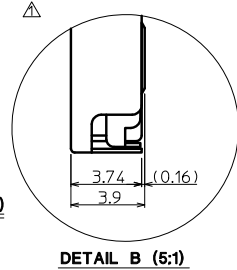
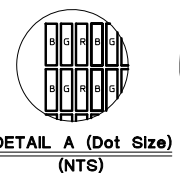
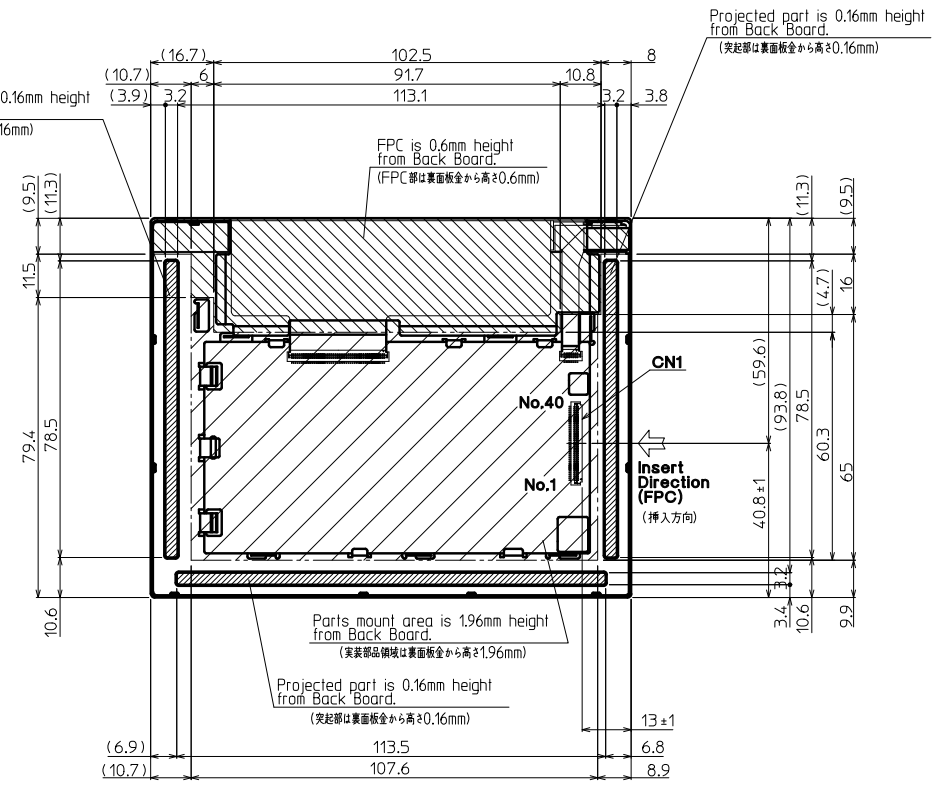
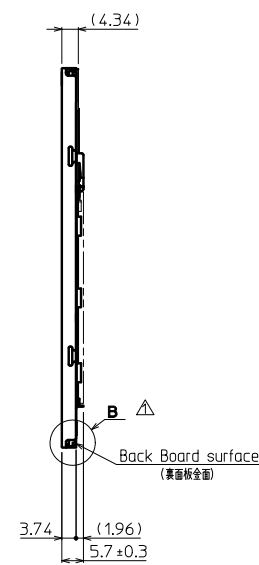
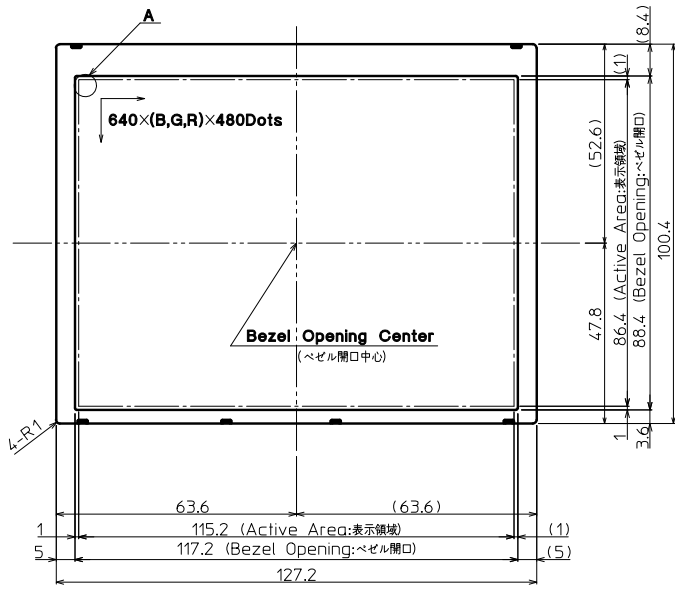

Note. (注記)  
 1. Connector CN1: IMSA-9681S-40A-GF (IRISO) (コネクタ)  
 2. The Information of LCD is displayed starting at the upper left hand corner, moving right then down to the lower right hand corner. (LCDにおいて、画像データの表示は左上コーナーから始まり、右へ進み下へ送られ右下コーナーへ向かう.)  
 3. Tolerance without indication: ±0.5 (指示無き公差)

Material 材質	Treatment 処理	Approved '07.09.04	Checked '07.09.04	Checked '07.09.04	Drawn 倉元	Scale 1:1(5:1,NTS)	Title TCG057VGLBA	KYOCERA	Year-Month-Day '07.09.02	Size 2
Quantity 製作数	Description 備考	RoHS					Outline Dimensions		Drawing No. 121A5063000-1	

※取り付け例(Installation guidance)

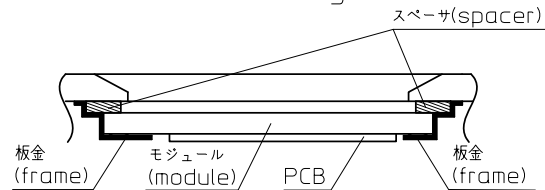

参考(for Reference)

No	Description	Drawn	Checked	Checked	Approved

局所的な過負荷禁止エリア(No over pressure in this area)

必要以上の負荷により、IC破損の可能性あり  
(Excessive pressure may damage driver ICs.)  
実験値(Experimental value):Max. 75kPa

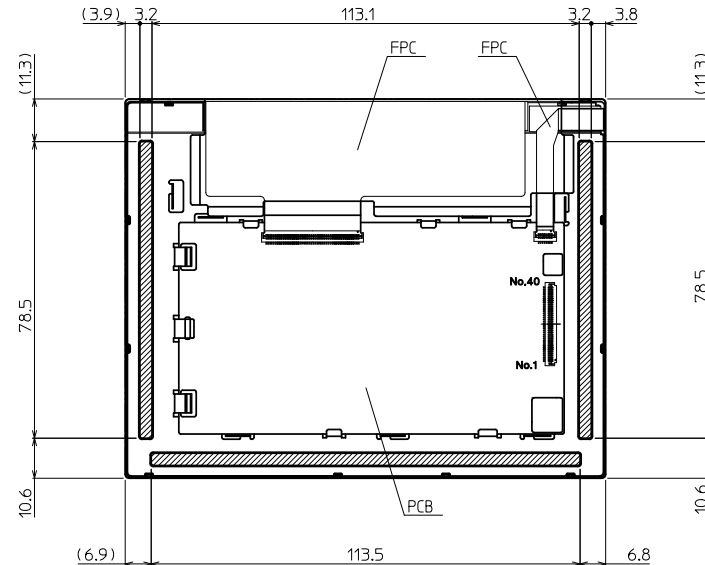
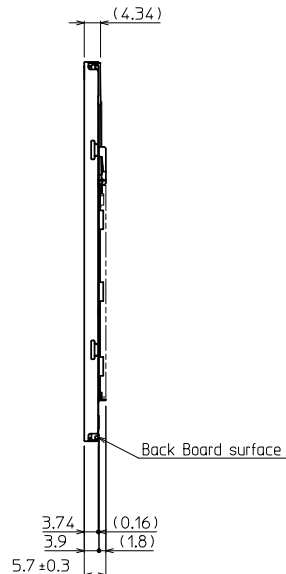
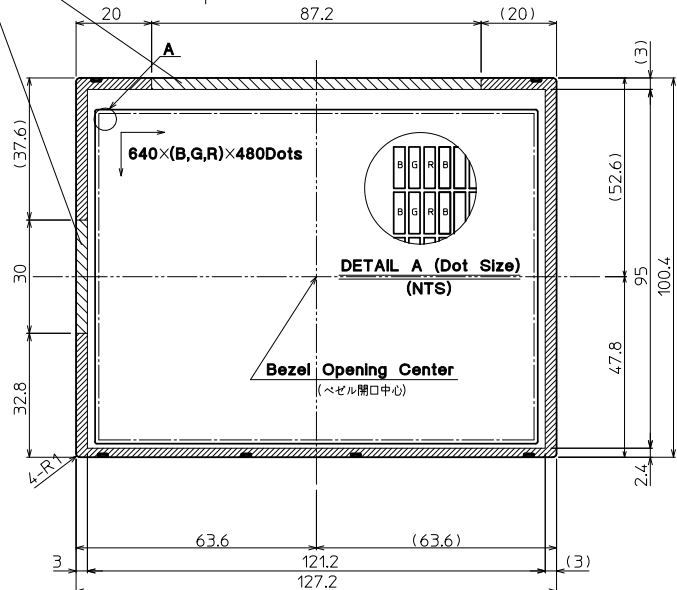

取り付け方法  
(Installation of the LCD)

ケースにモジュールをはめ込み(X,y固定)、裏面からZ方向を固定する事が可能。  
(The LCD module shall be held in the X/Y direction by the housing, and in the Z direction using a backboard.)

斜線部の領域にて、下記の条件を満たし押さえることが望ましい。  
(To hold the LCD module in place, it shall be supported with pressure applied to the hatched areas indicated by the descriptions below.)

- 押さえつけ可能領域  
(Pressure may be applied in this area.)
- 押さえつけ可能領域、但し、局所的な過負荷禁止。  
(No "point" over pressure is allowed.)

表面取り付け条件  
(Installation conditions (Front side))

- 1.上辺長辺側、左右短辺中央部に局所的な負荷がかからないように取り付けのこと  
(1. The LCD shall be installed so that there is no point pressure applied in the middle of the left, right, and upper border around the viewing area.)
- 2.広い範囲で均一に押さえることが望ましい  
(2. The LCD shall be uniformly supported over as wide an area as possible.)

注記(Note)  
指定外公差 (Tolerance without indication) :±0.5

裏面取り付け条件  
(Installation conditions (Back side))

- 1.PCBへの接触無きこと  
(1. Do not allow any foreign material to contact the PCB.)
- 2.FPCエリア押さえ不可  
(2. Do not use any part of the FPC area to hold the LCD module in place)
- 3.PCB周りの板金突起部押さえ不可  
(3. Do not apply pressure on the projected metal part of the PCB.)
- 4.モジュールがたわむこと無きよう押さえつけのこと  
(4. Do not allow the LCD module to bend or twist.)
- 5.広い範囲で均一に押さえることが望ましい  
(5. Support the LCD with uniform pressure over as wide an area as possible.)

Material 材質	Treatment 処理	Approved '07.12.14	Checked	Checked '07.12.14	Drawn 倉元	Scale 1:1(NTS)	Title TCG057VGLBA	KYOCERA Year-Month-Day '07.12.12	Size 2
Quantity 製作数	Description 備考	朝倉	鶴崎	倉元	モジュール取り付け方法	Drawing No. 121A5065800			

Spec No.	TQ3C-8EAF0-E2DDP48-00
Date	May 22, 2008

**KYOCERA INSPECTION STANDARD**

**TYPE : TCG057VGLBA-G20**

KYOCERA CORPORATION  
KAGOSHIMA HAYATO PLANT  
LCD DIVISION

Original Issue Date	Designed by : Engineering dept.			Confirmed by : QA dept.	
	Prepared	Checked	Approved	Checked	Approved
May 22, 2008	<i>D. Ajisaka</i>	<i>Y. Tokumori</i>	<i>G. Matsumoto</i>	<i>J. Sakaguchi</i>	<i>T. Ito</i>

Spec No. TQ3C-8EAF0-E2DDP48-00	Part No. TCG057VGLBA-G20	Page -
-----------------------------------	-----------------------------	-----------

**Revision record**

Date		Designed by : Engineering dept.			Confirmed by : QA dept.	
		Prepared	Checked	Approved	Checked	Approved
Rev.No.	Date	Page	Descriptions			

## Visuals specification

### 1) Note

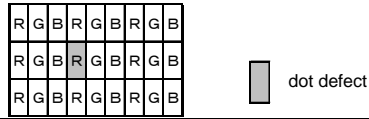
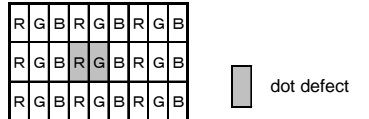
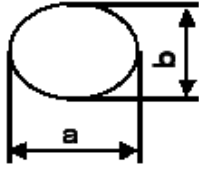
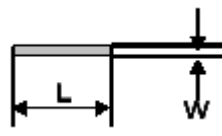
		Note
General	<p>1. Customer identified anomalies not defined within this inspection standard shall be reviewed by Kyocera, and an additional standard shall be determined by mutual consent.</p> <p>2. This inspection standard about the image quality shall be applied to any defect within the active area and shall not be applicable to outside of the area.</p> <p>3. Inspection conditions</p> <p>Luminance : 500 Lux min.</p> <p>Inspection distance : 300 mm.</p> <p>Temperature : 25 ± 5</p> <p>Direction : Directly above</p>	
Definition of inspection item	Dot defect	<p>Bright dot defect</p> <p>The dot is constantly “on” when power applied to the LCD, even when all “Black” data sent to the screen. Inspection tool: 5% Transparency neutral density filter. Count dot: If the dot is visible through the filter. Don't count dot: If the dot is not visible through the filter.</p> 
		<p>Black dot defect</p> <p>The dot is constantly “off” when power applied to the LCD, even when all “White” data sent to the screen.</p>
		<p>Adjacent dot</p> <p>Adjacent dot defect is defined as two or more bright dot defects or black dot defects.</p> 
	External inspection	<p>Bubble, Scratch, Foreign particle (Polarizer, Cell, Backlight)</p> <p>Visible operating (all pixels “Black” or “White”) and non operating.</p>
		<p>Appearance inspection</p> <p>Does not satisfy the value at the spec.</p>
	Others	<p>LED wire</p> <p>Damaged to the LED wires, connector, pin, functional failure or appearance failure.</p>
	Definition of size	<p>Definition of circle size</p>  <p><math>d = (a + b) / 2</math></p> <p>Definition of linear size</p> 

2) Standard

Classification		Inspection item	Judgement standard																										
Defect (in LCD glass)	Dot defect	Bright dot defect	Acceptable number : 4 Bright dot spacing : 5 mm or more																										
		Black dot defect	Acceptable number : 5 Bright dot spacing : 5 mm or more																										
		2 dot join	Bright dot defect	Acceptable number : 2																									
			Black dot defect	Acceptable number : 3																									
		3 or more dots join	Acceptable number : 0																										
		Total dot defects	Acceptable number : 5 Max																										
	Others	White dot, Dark dot (Circle)	<table border="1"> <thead> <tr> <th colspan="2">Size (mm)</th> <th>Acceptable number</th> </tr> </thead> <tbody> <tr> <td>d</td> <td>0.2</td> <td>(Neglected)</td> </tr> <tr> <td>0.2 &lt; d</td> <td>0.4</td> <td>5</td> </tr> <tr> <td>0.4 &lt; d</td> <td>0.5</td> <td>3</td> </tr> <tr> <td>0.5 &lt; d</td> <td></td> <td>0</td> </tr> </tbody> </table>			Size (mm)		Acceptable number	d	0.2	(Neglected)	0.2 < d	0.4	5	0.4 < d	0.5	3	0.5 < d		0									
Size (mm)		Acceptable number																											
d	0.2	(Neglected)																											
0.2 < d	0.4	5																											
0.4 < d	0.5	3																											
0.5 < d		0																											
External inspection (Defect on Polarizer or between Polarizer and LCD glass)	Polarizer (Scratch)	<table border="1"> <thead> <tr> <th colspan="2">Width (mm)</th> <th colspan="2">Length (mm)</th> <th>Acceptable number</th> </tr> </thead> <tbody> <tr> <td>W</td> <td>0.1</td> <td colspan="2">-</td> <td>(Neglected)</td> </tr> <tr> <td rowspan="2">0.1 &lt; W</td> <td rowspan="2">0.3</td> <td colspan="2">L 5.0</td> <td>(Neglected)</td> </tr> <tr> <td colspan="2">5.0 &lt; L</td> <td>0</td> </tr> <tr> <td colspan="2">0.3 &lt; W</td> <td colspan="2">-</td> <td>0</td> </tr> </tbody> </table>			Width (mm)		Length (mm)		Acceptable number	W	0.1	-		(Neglected)	0.1 < W	0.3	L 5.0		(Neglected)	5.0 < L		0	0.3 < W		-		0		
		Width (mm)		Length (mm)		Acceptable number																							
		W	0.1	-		(Neglected)																							
		0.1 < W	0.3	L 5.0		(Neglected)																							
	5.0 < L			0																									
	0.3 < W		-		0																								
	Polarizer (Bubble)	<table border="1"> <thead> <tr> <th colspan="2">Size (mm)</th> <th>Acceptable number</th> </tr> </thead> <tbody> <tr> <td>d</td> <td>0.2</td> <td>(Neglected)</td> </tr> <tr> <td>0.2 &lt; d</td> <td>0.3</td> <td>5</td> </tr> <tr> <td>0.3 &lt; d</td> <td>0.5</td> <td>3</td> </tr> <tr> <td>0.5 &lt; d</td> <td></td> <td>0</td> </tr> </tbody> </table>			Size (mm)		Acceptable number	d	0.2	(Neglected)	0.2 < d	0.3	5	0.3 < d	0.5	3	0.5 < d		0										
		Size (mm)		Acceptable number																									
		d	0.2	(Neglected)																									
		0.2 < d	0.3	5																									
0.3 < d	0.5	3																											
0.5 < d		0																											
Foreign particle (Circular shape)	<table border="1"> <thead> <tr> <th colspan="2">Size (mm)</th> <th>Acceptable number</th> </tr> </thead> <tbody> <tr> <td>d</td> <td>0.2</td> <td>(Neglected)</td> </tr> <tr> <td>0.2 &lt; d</td> <td>0.4</td> <td>5</td> </tr> <tr> <td>0.4 &lt; d</td> <td>0.5</td> <td>3</td> </tr> <tr> <td>0.5 &lt; d</td> <td></td> <td>0</td> </tr> </tbody> </table>			Size (mm)		Acceptable number	d	0.2	(Neglected)	0.2 < d	0.4	5	0.4 < d	0.5	3	0.5 < d		0											
	Size (mm)		Acceptable number																										
	d	0.2	(Neglected)																										
	0.2 < d	0.4	5																										
0.4 < d	0.5	3																											
0.5 < d		0																											
Foreign particle (Linear shape) Scratch	<table border="1"> <thead> <tr> <th colspan="2">Width (mm)</th> <th colspan="2">Length (mm)</th> <th>Acceptable number</th> </tr> </thead> <tbody> <tr> <td>W</td> <td>0.03</td> <td colspan="2">-</td> <td>(Neglected)</td> </tr> <tr> <td rowspan="3">0.03 &lt; W</td> <td rowspan="3">0.1</td> <td colspan="2">L 2.0</td> <td>(Neglected)</td> </tr> <tr> <td colspan="2">2.0 &lt; L 4.0</td> <td>3</td> </tr> <tr> <td colspan="2">4.0 &lt; L</td> <td>0</td> </tr> <tr> <td colspan="2">0.1 &lt; W</td> <td colspan="2">-</td> <td>(According to circular shape)</td> </tr> </tbody> </table>			Width (mm)		Length (mm)		Acceptable number	W	0.03	-		(Neglected)	0.03 < W	0.1	L 2.0		(Neglected)	2.0 < L 4.0		3	4.0 < L		0	0.1 < W		-		(According to circular shape)
	Width (mm)		Length (mm)		Acceptable number																								
	W	0.03	-		(Neglected)																								
	0.03 < W	0.1	L 2.0		(Neglected)																								
			2.0 < L 4.0		3																								
4.0 < L			0																										
0.1 < W		-		(According to circular shape)																									