

SBD Type : TCH10A15

OUTLINE DRAWING

FEATURES

- *SQUARE-PAK TO-263AB(SMD)
- Packaged in 24mm Tape and Reel
- *Dual Diodes – Cathode Common
- *Low Forward Voltage Drop
- *High Surge Capability
- *Tj=150 °C operation

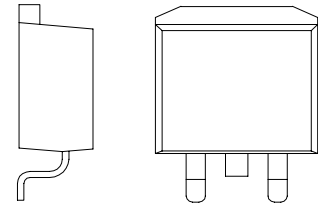
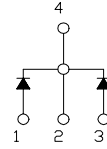

Maximum Ratings

Approx Net Weight: 1.4g

Rating	Symbol	TCH10A15		Unit
Repetitive Peak Reverse Voltage	V_{RRM}	150		V
Average Rectified Output Current	I_O	10	Tc=121°C 50 Hz Full Sine Wave Resistive Load	A
RMS Forward Current	$I_{F(RMS)}$	11.1		A
Surge Forward Current	I_{FSM}	130	50Hz Full Sine Wave ,1cycle Non-repetitive	A
Operating JunctionTemperature Range	T_{jw}	-40 to +150		°C
Storage Temperature Range	T_{stg}	-40 to +150		°C

Electrical • Thermal Characteristics

Characteristics	Symbol	Conditions	Min.	Typ.	Max.	Unit
Peak Reverse Current	I_{RM}	Tj= 25°C, $V_{RM}= V_{RRM}$ per arm	-	-	1	mA
Peak Forward Voltage	V_{FM}	Tj= 25°C, $I_{FM}= 5 A$ per arm	-	-	0.88	V
Thermal Resistance (Junction to Case)	Rth(j-c)	Junction to Case	-	-	3	°C /W

C_T_ OUTLINE DRAWING (Dimensions in mm)



SOLDERING PAD

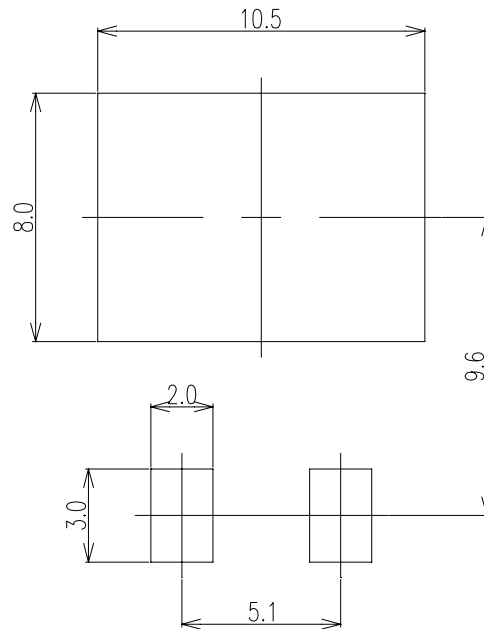

FORWARD CURRENT VS. VOLTAGE

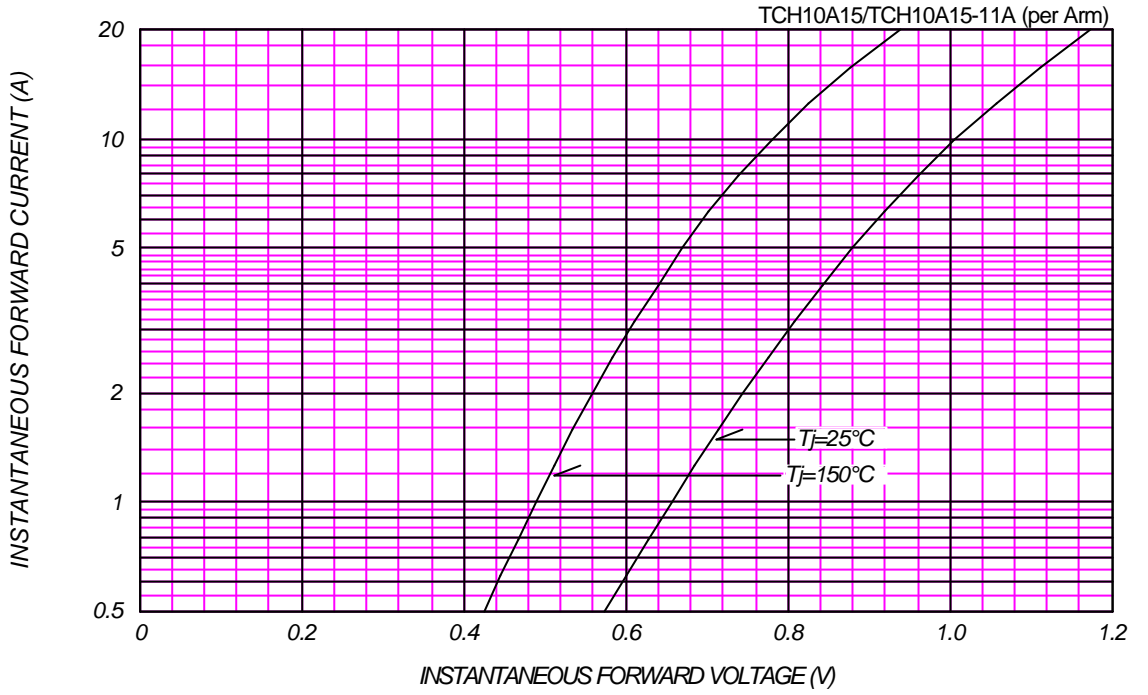

AVERAGE FORWARD POWER DISSIPATION

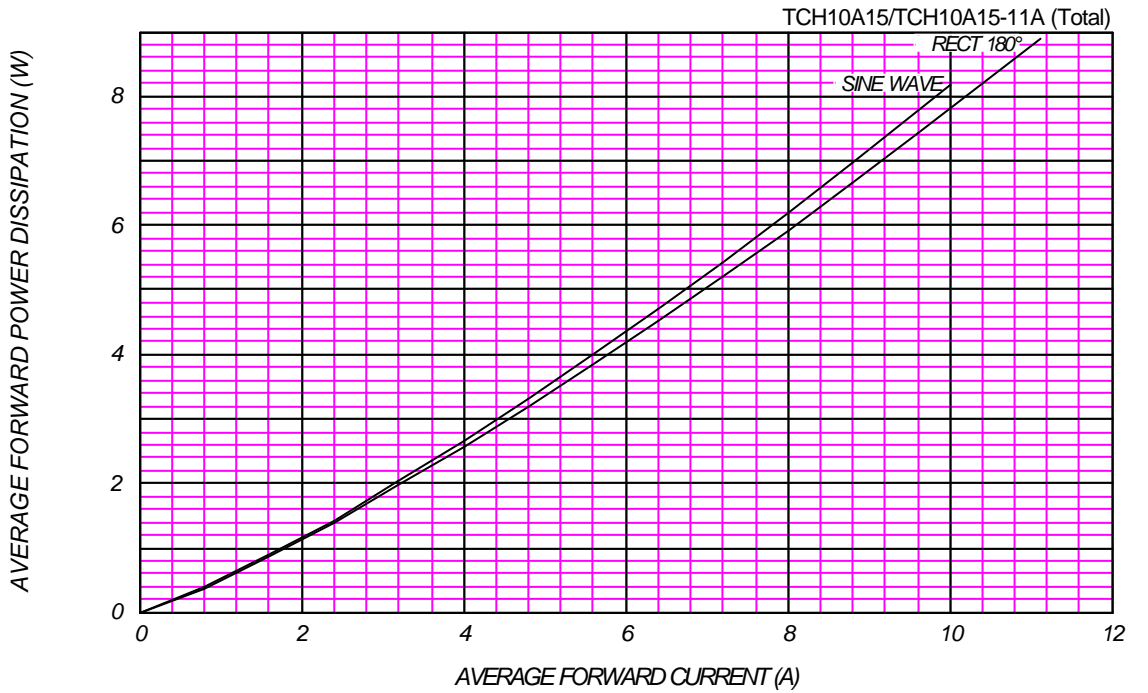

PEAK REVERSE CURRENT VS. PEAK REVERSE VOLTAGE

T_j = 150 °C

TCH10A15/TCH10A15-11A (per Arm)

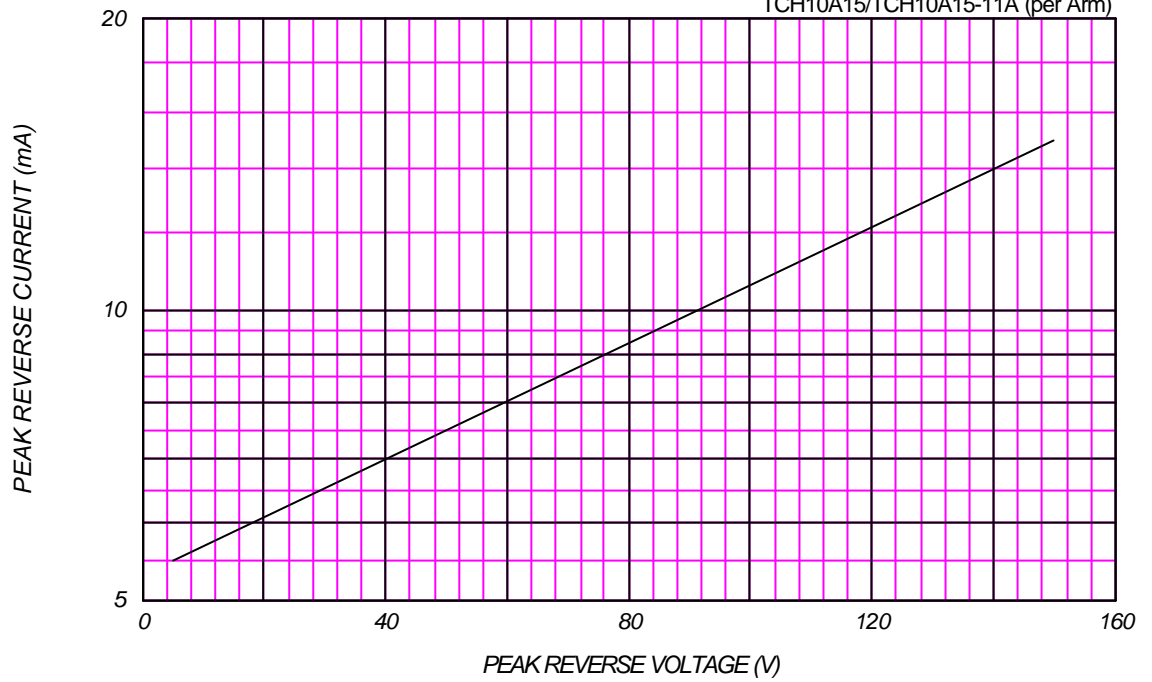

AVERAGE REVERSE POWER DISSIPATION

TCH10A15/TCH10A15-11A (Total)

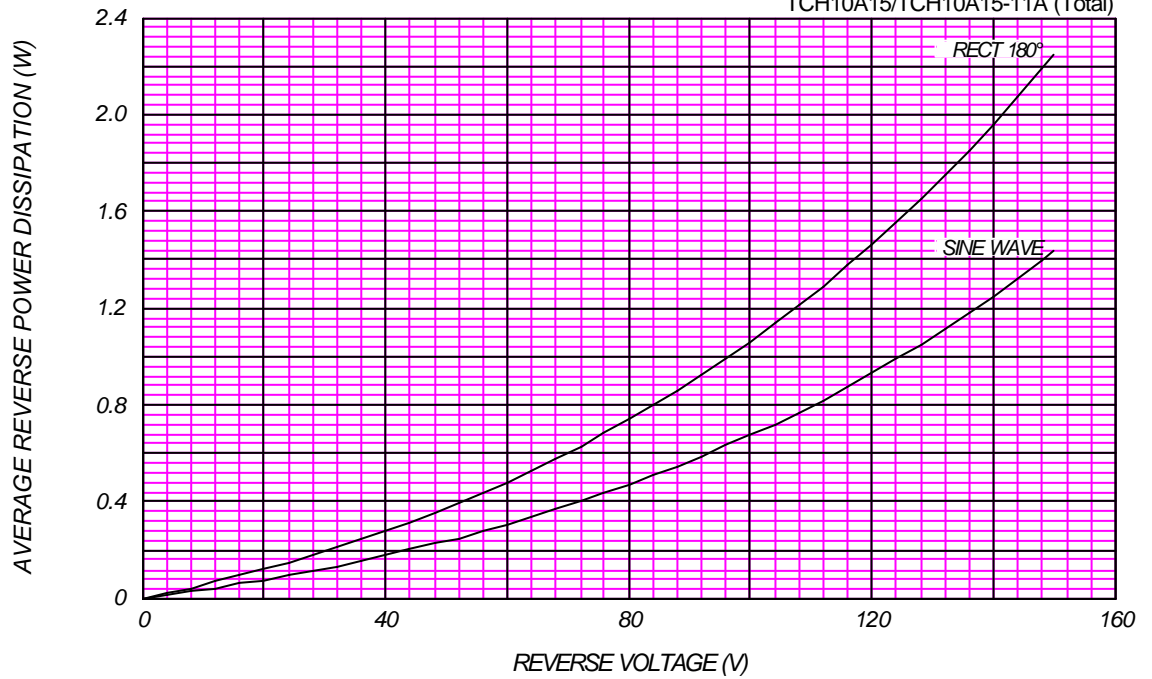



AVERAGE FORWARD CURRENT VS. CASE TEMPERATURE

$V_{RM} = 150V$

TCH10A15/TCH10A15-11A (Total)

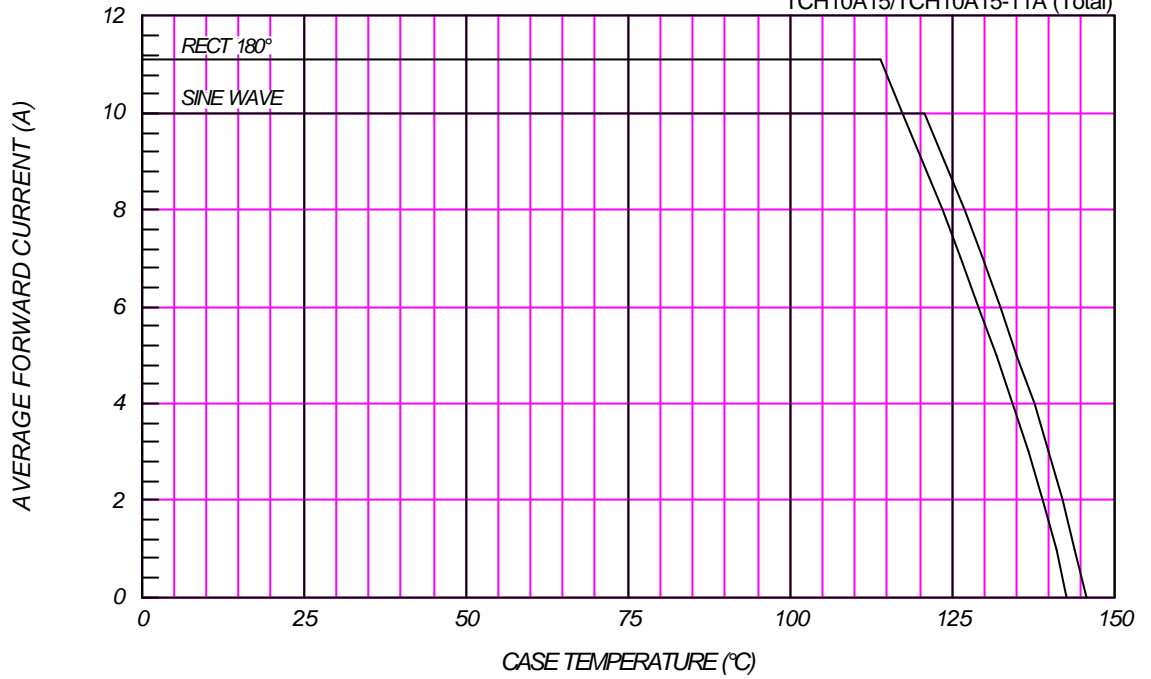

SURGE CURRENT RATINGS

$f = 50Hz$, Sine Wave, Non-Repetitive, No Load

TCH10A15/TCH10A15-11A

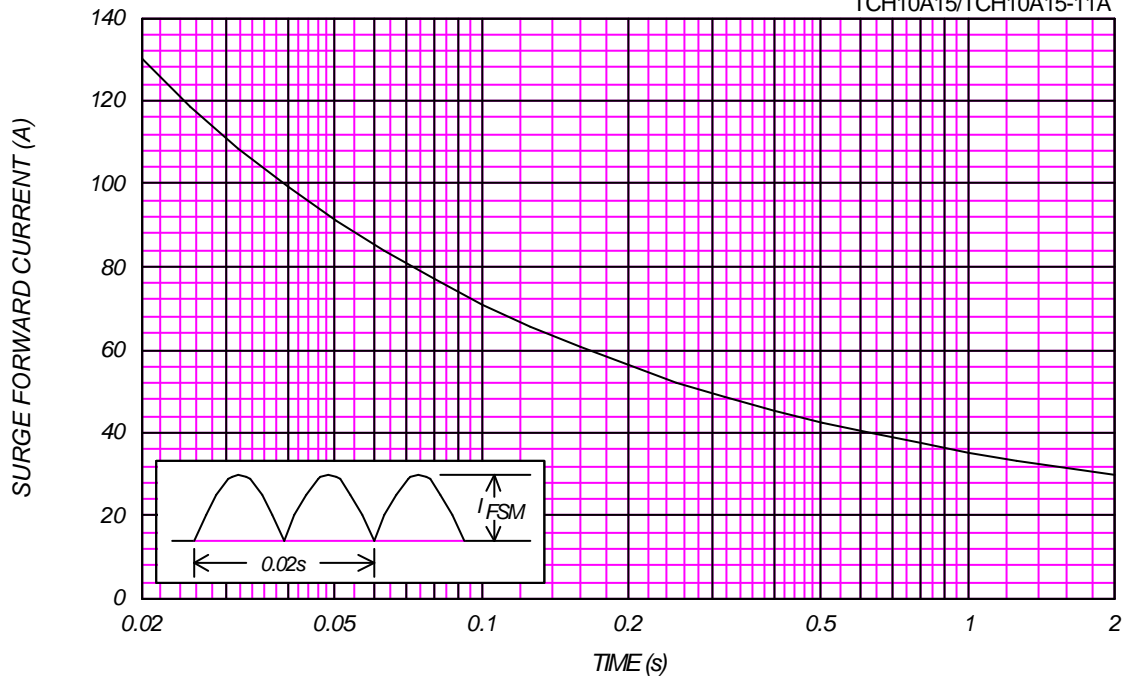

JUNCTION CAPACITANCE VS. REVERSE VOLTAGE

$T_j=25^\circ\text{C}$, $V_m=20\text{mV}_{\text{RMS}}$, $f=100\text{kHz}$, Typical Value

TCH10A15/TCH10A15-11A (per Arm)

