

## Common mode filters

## High-speed differential signal line (USB2.0, LVDS, etc.)

## TCM-R series



# TCM0403R type



## FEATURES

- Thin-film common mode filter based on the thin-film processing techniques and material technology cultivated from HDD head manufacturing.
- Has EMC suppression by achieving wide frequency range (cutoff frequency of 3GHz or higher) differential mode transmission while ensuring common mode impedance with virtually no affect on the high-speed differential transmission line signal.
- Lineup includes 0403 (L0.45×W0.30×T0.23mm), the industry's smallest thin-film common mode filter.
- Operating temperature range: -25 to +85°C

## APPLICATION

- Noise countermeasure for high-speed differential interfaces (USB2.0, LVDS, MIPI, etc.) for mobile devices and general consumer products such as smart phones, tablets, digital cameras, and portable music players.
- Application guides: [Smart phones/tablets](#)

## PART NUMBER CONSTRUCTION

TCM	0403	-	R	-	900	-	2P	-	T	210
Series name	L×W×T dimensions 0.45×0.3×0.23 mm		Product internal code		Characteristic internal code		Number of lines		Packaging style	Internal code

## CHARACTERISTICS SPECIFICATION TABLE

Common mode attenuation	DC resistance	Rated current	Rated voltage	Insulation resistance	Part No.
(dB)	[1 line] (Ω)	(A)max.	(V)max.	(MΩ)min.	
18min. @700M to 1.9GHz	3.5±30%	0.035	5	10	<a href="#">TCM0403R-900-2P-T210</a>
13min. @2.1G to 3.0GHz					

### Measurement equipment

Measurement item	Product No.	Manufacturer
Common mode attenuation	E5071B	Keysight Technologies
DC resistance	4338A	Keysight Technologies
Insulation resistance	4339A	Keysight Technologies

\* Equivalent measurement equipment may be used.

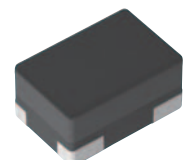

# TCM0403R type

## ■ IMPEDANCE VS. FREQUENCY CHARACTERISTICS

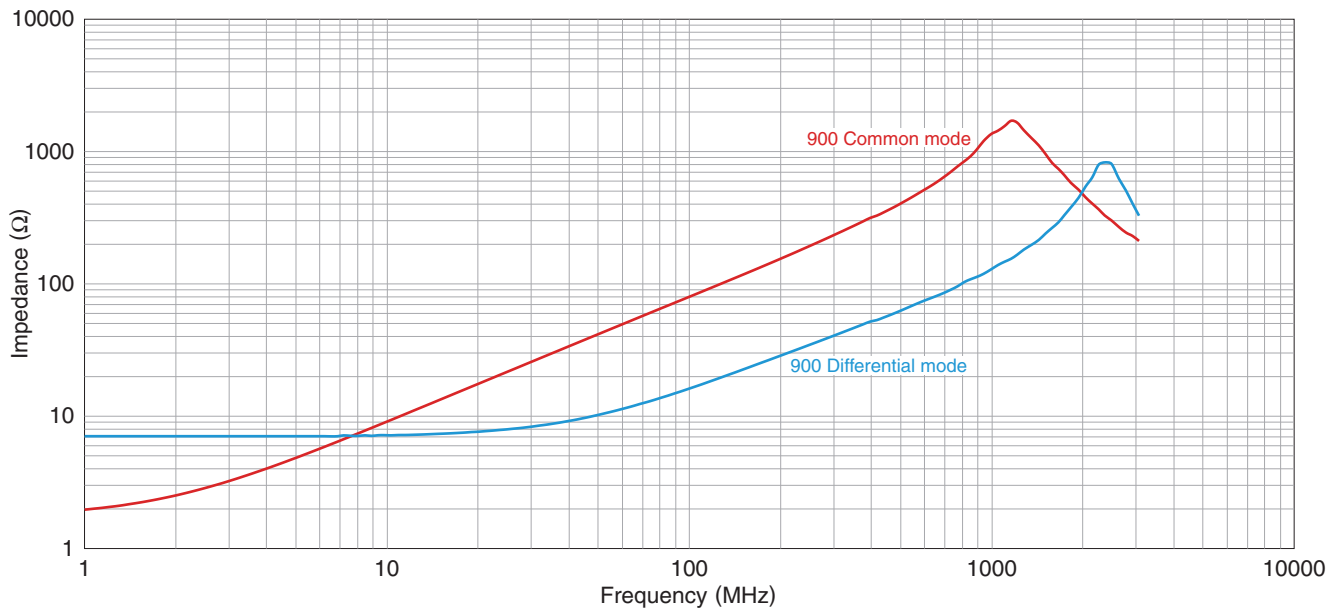

Measurement equipment

Product No.	Manufacturer
E4991A	Keysight Technologies

\* Equivalent measurement equipment may be used.

## ■ INSERTION LOSS VS. FREQUENCY CHARACTERISTICS

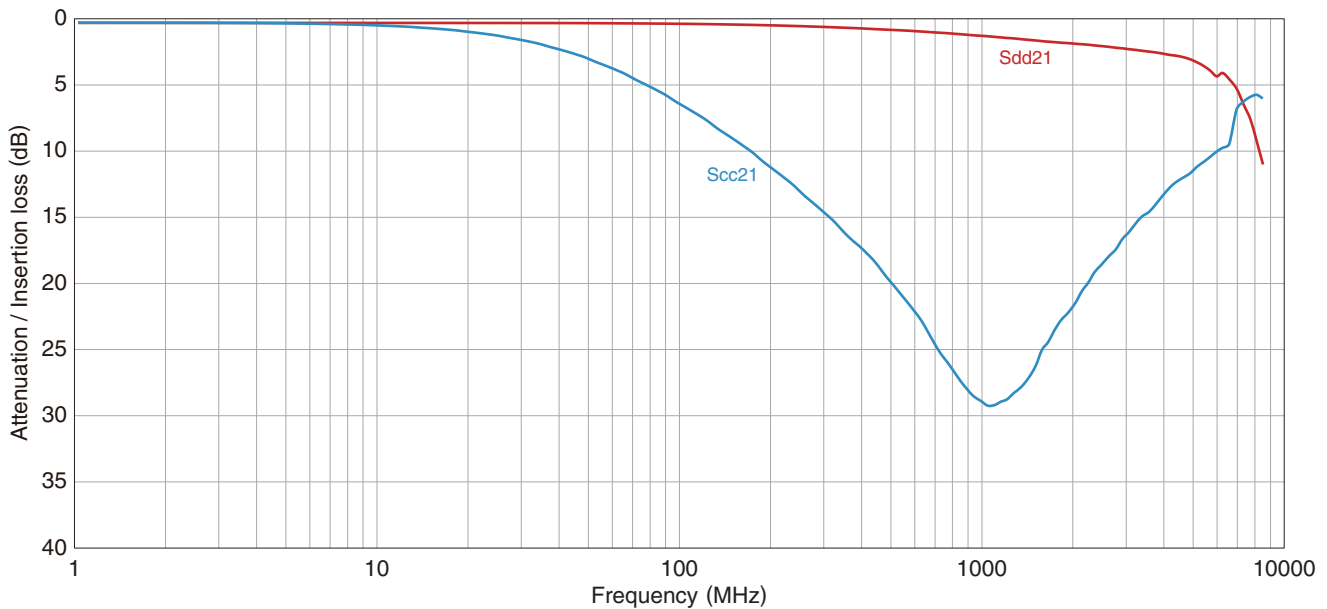

Measurement equipment

Product No.	Manufacturer
E5071B	Keysight Technologies

\* Equivalent measurement equipment may be used.

# TCM0403R type

## SHAPE & DIMENSIONS

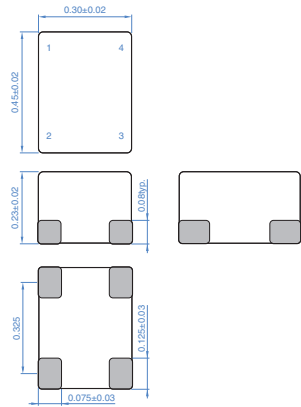

Dimensions in mm

## RECOMMENDED LAND PATTERN

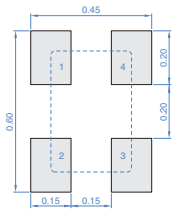

Dimensions in mm

## CIRCUIT DIAGRAM

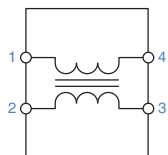

• No polarity

## RECOMMENDED REFLOW PROFILE

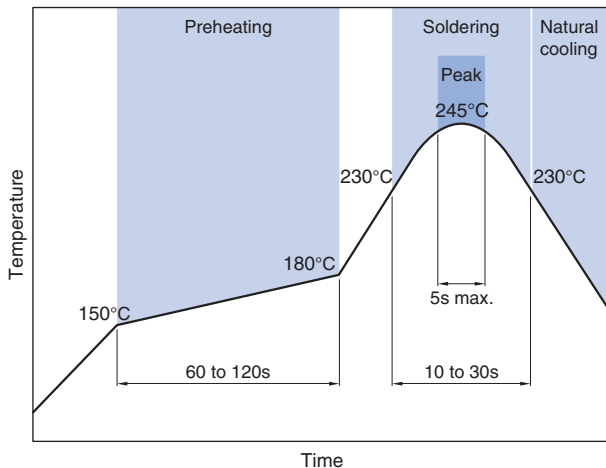

## PACKAGING STYLE

### REEL DIMENSIONS

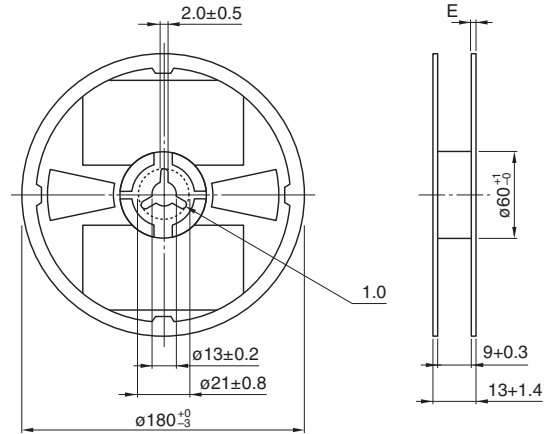

Dimensions in mm

### TAPE DIMENSIONS

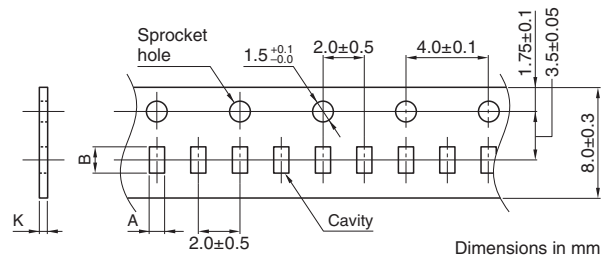

Dimensions in mm

Type	A	B	K
TCM0403R	0.40	0.55	0.27

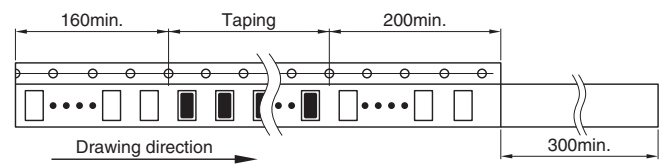

Dimensions in mm

### PACKAGE QUANTITY

Package quantity	10,000 pcs/reel
------------------	-----------------

### TEMPERATURE RANGE, INDIVIDUAL WEIGHT

Operating temperature range	Storage temperature range*	Individual weight
-25 to +85 °C	-25 to +85 °C	0.2 mg

\* The storage temperature range is for after the assembly.

## REMINDERS FOR USING THESE PRODUCTS

Before using these products, be sure to request the delivery specifications.

### SAFETY REMINDERS

Please pay sufficient attention to the warnings for safe designing when using this products.

#### REMINDERS

- The storage period is less than 6 months. Be sure to follow the storage conditions (temperature: 5 to 40°C, humidity: 20 to 70% RH or less).  
If the storage period elapses, the soldering of the terminal electrodes may deteriorate.
- Do not use or store in locations where there are conditions such as gas corrosion (salt, acid, alkali, etc.).
- Before soldering, be sure to preheat components.  
The preheating temperature should be set so that the temperature difference between the solder temperature and chip temperature does not exceed 150°C.
- Soldering corrections after mounting should be within the range of the conditions determined in the specifications.  
If overheated, a short circuit, performance deterioration, or lifespan shortening may occur.
- When embedding a printed circuit board where a chip is mounted to a set, be sure that residual stress is not given to the chip due to the overall distortion of the printed circuit board and partial distortion such as at screw tightening portions.
- Self heating (temperature increase) occurs when the power is turned ON, so the tolerance should be sufficient for the set thermal design.
- Carefully lay out the coil for the circuit board design of the non-magnetic shield type.  
A malfunction may occur due to magnetic interference.
- Use a wrist band to discharge static electricity in your body through the grounding wire.
- Do not expose the products to magnets or magnetic fields.
- Do not use for a purpose outside of the contents regulated in the delivery specifications.
- The products listed on this catalog are intended for use in general electronic equipment (AV equipment, telecommunications equipment, home appliances, amusement equipment, computer equipment, personal equipment, office equipment, measurement equipment, industrial robots) under a normal operation and use condition.  
The products are not designed or warranted to meet the requirements of the applications listed below, whose performance and/or quality require a more stringent level of safety or reliability, or whose failure, malfunction or trouble could cause serious damage to society, person or property.  
If you intend to use the products in the applications listed below or if you have special requirements exceeding the range or conditions set forth in the each catalog, please contact us.

- (1) Aerospace/aviation equipment
- (2) Transportation equipment (cars, electric trains, ships, etc.)
- (3) Medical equipment
- (4) Power-generation control equipment
- (5) Atomic energy-related equipment
- (6) Seabed equipment
- (7) Transportation control equipment

- (8) Public information-processing equipment
- (9) Military equipment
- (10) Electric heating apparatus, burning equipment
- (11) Disaster prevention/crime prevention equipment
- (12) Safety equipment
- (13) Other applications that are not considered general-purpose applications

When designing your equipment even for general-purpose applications, you are kindly requested to take into consideration securing protection circuit/device or providing backup circuits in your equipment.