

TOSHIBA C²MOS DIGITAL INTEGRATED CIRCUIT SILICON MONOLITHIC

TCM8240MD

Ver 1.2**13/Nov/04**

TENTATIVE

1.3 Mega pixel sensor chip

TCM8240MD is an area color image sensor , at 1.3 Mega-pixels of array resolution (1300x 1040) , incorporating a camera signal processor . The optical format is 1/3.3 inch, of which small size is suitable for built-in camera module application. Use of the CMOS process makes possible low power consumption operations. This sensor provides superb picture quality thanks to Toshiba's advanced sensor technology and Toshiba's sophisticated signal processing technology.

Features

1. General

- Large flexibility in external clock frequency range by PLL operation (JPEG is not available in case of w/o PLL operation)
- Frame rate : up to 15 fps for every resolution
- Output data rate reduction for full 1.3 Mega resolution by JPEG compression
- Dual power supply : Either 2.5+/-0.2V or 2.8 +/- 0.2 V, and **1.6+/-0.1V**
- Operation temperature : -20 to + 60 degree C
- Storage temperature : -30 to +85 degree C

2. Sensor

- Optical size : 1/3.3 inch optical format
- Effective pixel numbers : 1300(H) x 1040(V)
- Output pixel number : 1280(H) x1024 (V) maximum
- Pixel pitch : 3.3um(H)x3.3um(V) (square pixel)
- Image size : 4.29 mm(H) x 3.43mm(V)
- Color filter : Primary color filter, Bayer arrangement

3. Camera signal processing

- Digital output mode
Output terminals: 8bit parallel data output along with DCLK, HBLK, and VBLK
(1) YUV=4:2:2 or RGB=5:6:5 data (multiplexed 8bit parallel output)
(2) JPEG encoded data (8 bit parallel) for full 1.3 Mega data
- Multi-step digital zoom for downsized VGA, QVGA, QQVGA, CIF, QCIF and subQCIF
- Vertical and horizontal flip
- ALC (automatic luminance level control) with fluorescent flicker-less operation
- AWB (automatic white balance)
- Automatic blemish detection and correction
- Strobe pulse for flash trigger

TOSHIBA is continually working to improve the quality and the reliability of its products. Nevertheless, semiconductor devices in general can malfunction or fail due to their inherent electrical sensitivity and vulnerability to physical stress. It is the responsibility of the buyer, when utilizing TOSHIBA products, to observe standards of safety, and to avoid situations in which a malfunction or failure of a TOSHIBA product could cause loss of human life, bodily injury or damage to property. In developing your designs, please ensure that TOSHIBA products are used within specified operating range as set forth in the most recent products specifications. Also, please keep in mind the precautions and conditions set forth in the TOSHIBA Semiconductor Reliability Handbook.

The products described in this document are subject to foreign exchange and foreign trade control laws.

The information contained herein is presented only as a guide for the applications of our products. No responsibility is assumed by TOSHIBA CORPORATION for any infringements of intellectual property or other rights of the third parties which may result from its use. No license is granted by implication or otherwise under any intellectual property or other rights of TOSHIBA CORPORATION or others.

The information contained herein is subject to change without notice.

CHANGE HISTORY

Specifications draft V0.4	December 9, '03
Specifications draft V1.0	October 14, '04
Specifications draft V1.1	October 14, '04
Specifications draft V1.2	November 13, '04

LIST OF ABBREVIATION

VGA	Video Graphic Array
CIF	Common Intermediate Format
CDS	Correlated Double Sampling
AGC	Automatic Gain Control
ADC	Analog to Digital Converter
TG	Timing Generator
SG	Sync Signal Generator
PLL	Phase Locked Loop
VCO	Voltage Controlled Oscillator
AWB	Automatic white Balance
OB	Optical black
ALC	Automatic Luminance level control
SOI	Start of Image (in JPEG data stream)
EOI	End of Image (in JPEG data stream)
MCU	Minimum Coded Unit
DQT	Define Quantization table
DHT	Define Huffman Table
SOF	Start of Frame
SOS	Start of Scan
DRI	Define Restart Interval

BLOCK DIAGRAM

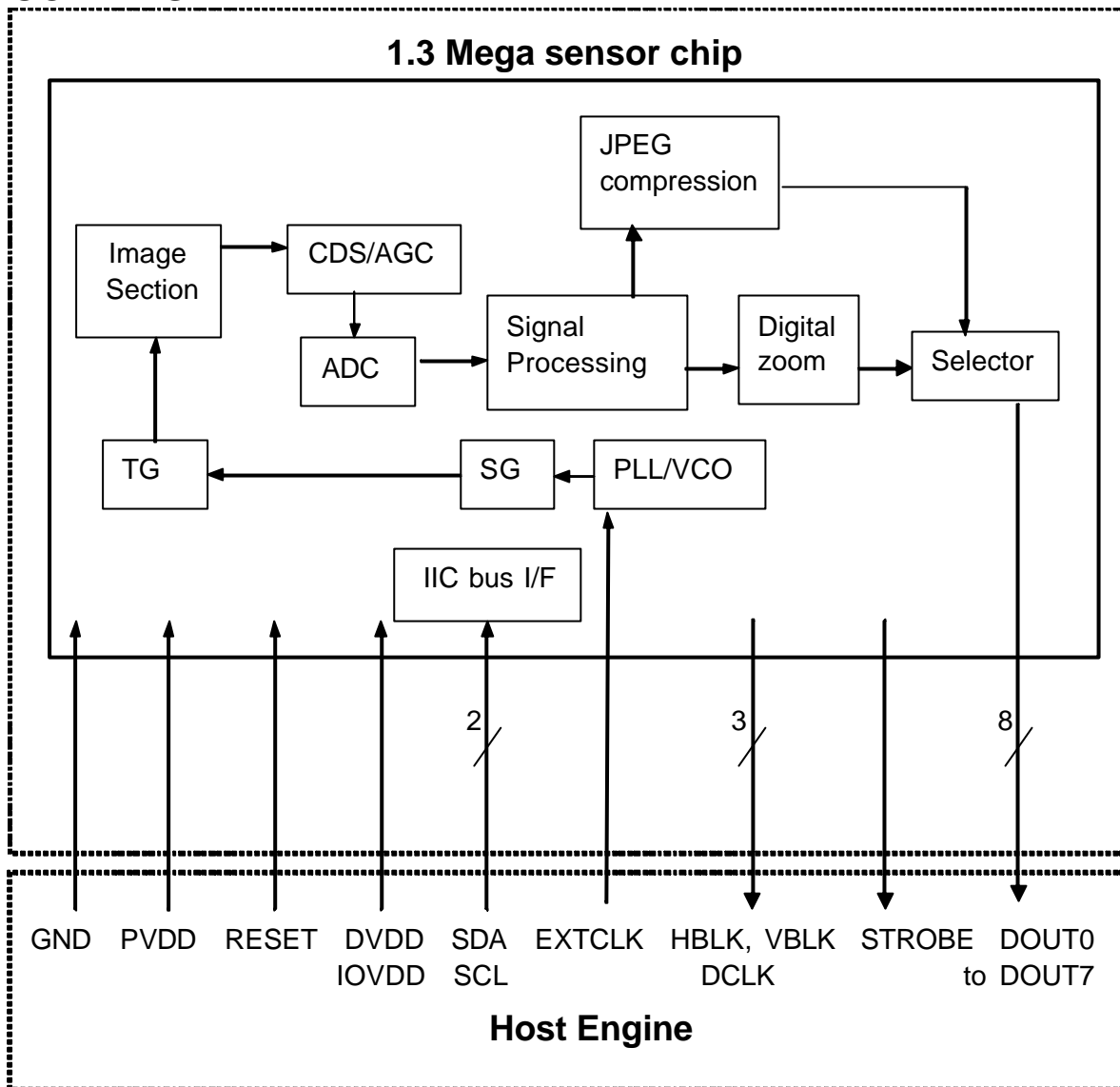

PIN DESCRIPTION

PIN No.	SYMBOL	I/O	DESCRIPTION
1	DOUT3	O	Data output
2	DOUT2	O	Data output
3	DOUT1	O	Data output
4	DOUT0	O	Data output (LSB)
5	GND		GND
6	PVDD	I	Power supply 2.8+/-0.2V or 2.5+/-0.2V
7	RESET	I	Reset pulse to initialize
8	SCL	I	Clock for I2C bus
9	GND		GND
10	SDA	I/O	Data for I2C bus
11	GND		GND
12	DVDD	I	Power supply 1.8+/-0.1V
13	EXTCLK	I	External clock input
14	STROBE	O	Trigger pulse for flash strobe
15	HBLK	O	Horizontal data blanking period
16	VBLK	O	Vertical data blanking period
17	GND		GND
18	IOVDD	I	Power supply 2.8+/-0.2V or 2.5+/-0.2V
19	DCLK	O	Clock for output data
20	GND		GND
21	DOUT7	O	Data output (MSB)
22	DOUT6	O	Data output
23	DOUT5	O	Data output
24	DOUT4	O	Data output

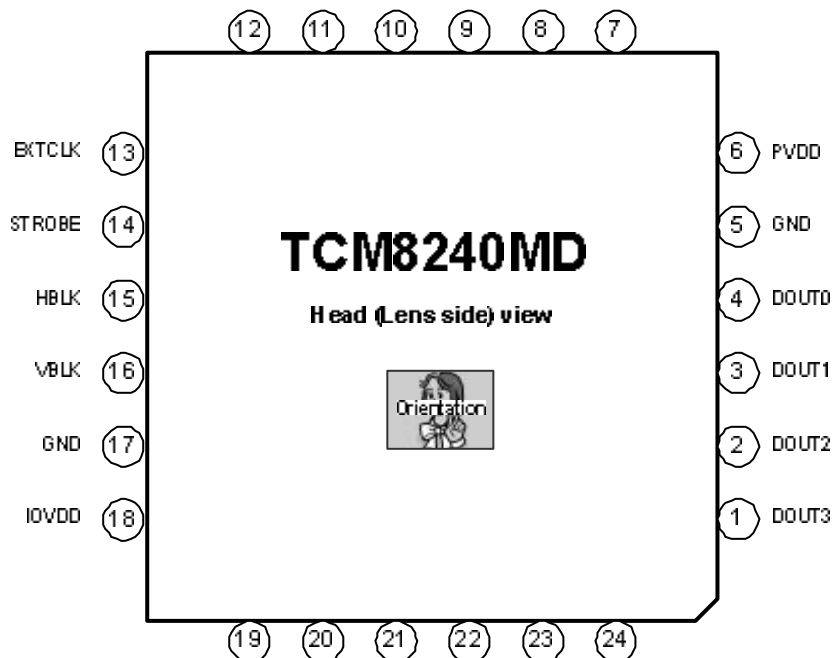

I/O INTERNAL CIRCUITS

NAME	I/O	INTERFACE CIRCUIT
RESET	I	
SCL	I	
SDA	I/O	
EXTCLK	I	
DOUT0 to DOUT7, HBLK, VBLK, DCLK, STROBE	O	

CONTROL I/F

TCM8240MD control interface configuration is based on fast mode IIC bus.
Register setting can be changed via IIC bus.

Write mode

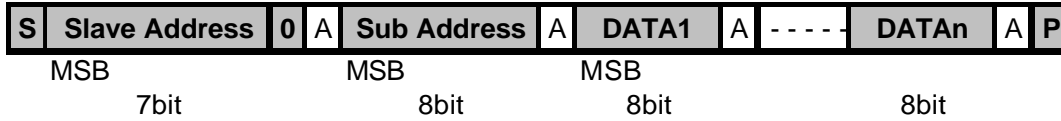

Read mode



S : Start condition , P : End condition , A : Acknowledge, A : not Acknowledge

Start condition , End condition

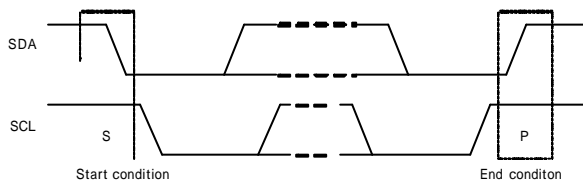

Bit Transfer

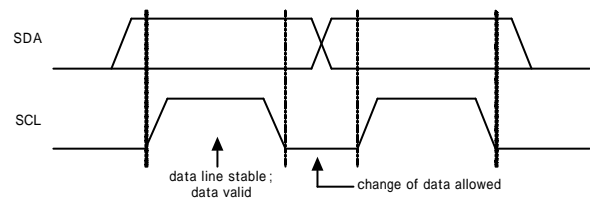

Acknowledge

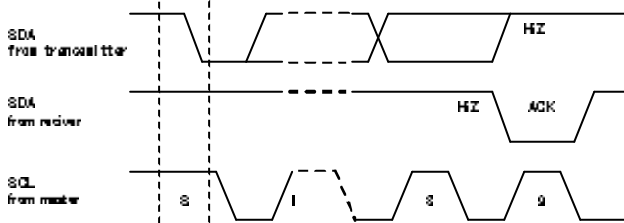

Not Acknowledge

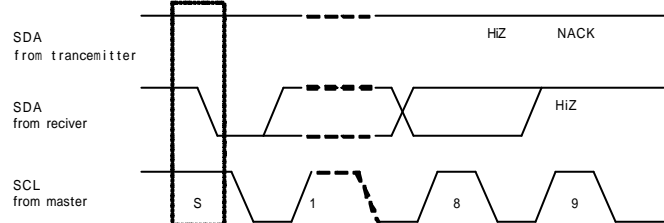

Slave address

A6	A5	A4	A3	A2	A1	A0	R/W
0	1	1	1	1	0	1	1/0

7bit Slave address is used.

Purchase of TOSHIBA I²C components conveys a license under the Philips I²C Patent Rights to use these components in an I²C system, provided that the system conforms to the I²C Standard Specification as defined by Philips.

INTERNAL REGISTER

Address [Dec]	Address [Hex]	Data (D7)	(D6)	(D5)	(D4)	(D3)	(D2)	(D1)	(D0)	Initial [Hex]
0	00									00
1	01									00
2	02	STANDBYSW	SRST							00
3	03				DCLKPOL	PLLMODE[3:0]				C0
4	04	DOUTOFF	JPEGON	PICMODE[1:0]		SELRGB	PICSIZ[2:0]			80
5	05	FRM_SPD[1:0]						LRINV		40
6	06	UDINV								18
7	07									00
8	08									08
9	09									00
10	0A									08
11	0B									36
12	0C									00
13	0D					VSUPCNT[1:0]				00
14	0E									AC
15	0F									00
16	10									FA
17	11									02
18	12									20
19	13									B2
20	14									33
21	15									32
22	16									28
23	17									00
24	18									00
25	19									00
26	1A	H_COUNT[7:0]								B3
27	1B	V_COUNT[3:0]						H_COUNT[9:8]		B2
28	1C			V_COUNT[9:4]						A1
29	1D			F_COUNT[5:0]						00
30	1E	SP_COUNT[7:0]								00
31	1F							SP_COUNT[11:8]		04
32	20									73
33	21									01
34	22	STSET_SW	STSET_POL			STSET_REG	ST_MODE[2:0]			07
35	23					STOUT_POL	STOUT_W[1:0]	ST_OUTSIG		F0
36	24									5E
37	25									10
38	26									01
39	27									32
40	28									40
41	29									58
42	2A									20
43	2B									10
44	2C	FRAME_LV[7:0]						FRAME_LV[9:8]		00
45	2D		CB_MODE[2:0]							0E
46	2E	DINSW								44
47	2F									00
48	30									00
49	31	APCSW								03
50	32									FF
51	33	IDRS[1:0]		AGMAX_PPED[0]	AGMIN_PPED[0]	PPEDB[0]	PPEDGB[0]	PPEDGR[0]	PPEDR[0]	00
52	34	PPEDR[8:1]								80
53	35	PPEDGR[8:1]								78
54	36	PPEDGB[8:1]								78
55	37	PPEDB[8:1]								80
56	38	AGMIN_PPED[8:1]								80
57	39	AGMAX_PPED[8:1]								80
58	3A									80
59	3B									80
60	3C									80
61	3D									80
62	3E	PWB_R[7:0]								66
63	3F	PWB_GR[7:0]								80

The registers of gray mesh (unassigned registers) are not able to read and write via I²C bus.
 “*” registers are read only.
 Don't touch TESTMODE registers.

Address [Dec]	Address [Hex]	Data [D7]	(D6)	(D5)	(D4)	(D3)	(D2)	(D1)	(D0)	Initial [Hex]
64	40	PWB_GB[7:0]								80
65	41	PWB_B[7:0]								96
66	42	PWB_BM[1:0]		PWB_GBM[1:0]		PWB_GRM[1:0]		PWB_RM[1:0]		41
67	43	LSCSW								00
68	44	LSC_RG[7:0]								FF
69	45	LSC_GG[7:0]								FF
70	46	LSC_BG[7:0]								FF
71	47	HLC_C SW								84
72	48	ALC SW	F AUTO SW	F AUTO DLY[1:0]		ALC_SSW	ALC_CSW[2:0]			85
73	49	ALCL[7:0]								50
74	4A	ALC_MODE[4:0]						ALCL[9:8]		48
75	4B	ALC_DLY[1:0]		ALCH[5:0]						C7
76	4C	ALC_DLY[9:2]								00
77	4D	L8P100S[7:0]								EE
78	4E	ALC_SPD[3:0]				L8P100S[11:8]				14
79	4F	L8P120S[7:0]								1C
80	50	ALC_HOLD				L8P120S[11:8]				04
81	51	EVS_MIN[7:0]								00
82	52	EVS_SW[1:0]		EVS_CUDSW				EVS_MIN[9:8]		20
83	53	EVS_MAX[7:0]								FF
84	54	EVS_MODE[4:0]						EVS_MAX[9:8]		03
85	55	HS_ES_LIM[2:0]				MHSS[3:0]				80
86	56	MES[7:0]								3B
87	57	MES[15:8]								01
88	58	LS_ES_LIM[3:0]						MES[17:16]		50
89	59	MDG[7:0]								00
90	5A	AG_MIN[7:0]								3F
91	5B	AG_MAX[7:0]								E7
92	5C	MAG[7:0]								80
93	5D	ALC_AG_POLE						MAG[9:8]		03
94	5E	ASC_AG[7:0]								00
95	5F	ACDET_SW	AC5060HZ	ACDET_DLY[1:0]				ASC_AG[9:8]		43
96	60									08
97	61									08
98	62									00
99	63									80
100	64									00
101	65	IDRE_SW				IDRE_CR[1:0]		IDRE_CL[1:0]		80
102	66	APBC_SW	PBC_SW[3:0]							D8
103	67	PBC_MODE[7:0]								BF
104	68	PBC1LV[7:0]								10
105	69	PBC2LV[7:0]								10
106	6A	PBC3LV[7:0]								60
107	6B	PBC4LV[7:0]								18
108	6C	VDS_HLPFSW[1:0]		HDS_VLPFSW[1:0]						02
109	6D	AWB_SW	AWB_MODE[1:0]			AWB_LOCK				21
110	6E	AWB_WAIT[1:0]		YLCUT_SW	RGCUT_SW			AWB_PN[2:0]		06
111	6F									00
112	70									40
113	71									C0
114	72									80
115	73									80
116	74									80
117	75									88
118	76									10
119	77									F0
120	78	YLCUT_L[7:0]								40
121	79	YLCUT_H[7:0]								C0
122	7A	UVIS_NC[7:0]								08
123	7B	AWB_SSP[7:0]								FF
124	7C	AWB_MSP[7:0]								FF
125	7D	WBG_SMIN[7:0]								33
126	7E	WBG_SMAX[7:0]								50
127	7F	WBG_MMIN[7:0]								20

The registers of gray mesh (unassigned registers) are not able to read and write via I²C bus.
 “*” registers are read only.
 Don't touch TESTMODE registers.

Address [Dec]	Address [Hex]	Data (D7)	(D6)	(D5)	(D4)	(D3)	(D2)	(D1)	(D0)	Initial [Hex]
128	80	WBG MMAX[7:0]								80
129	81	WB MRG[7:0]								40
130	82	WB MBG[7:0]								40
131	83	ST MRG[7:0]								40
132	84	ST MBG[7:0]								40
133	85									00
134	86	CLM G[7:0]								80
135	87	CLM S[7:0]								80
136	88	CLM MIN[7:0]								00
137	89	CLM MAX[7:0]								FF
138	8A	YUV G[7:0]								00
139	8B	YUV S[7:0]								00
140	8C	YUV MIN[7:0]								00
141	8D	YUV MAX[7:0]								00
142	8E									80
143	8F									80
144	90	UV G[7:0]								80
145	91	UV S[7:0]								80
146	92									00
147	93	CCB SW								A0
148	94									05
149	95	SCLPFG[7:0]								80
150	96	CBGMIN L[7:0]								A0
151	97	CBGMIN H[7:0]								E0
152	98	CBU YL[7:0]								60
153	99	CBD YL[7:0]								A8
154	9A	LCSMODE[3:0]								03
155	9B									60
156	9C									60
157	9D	LPFMODE				RGBLPFSW[3:0]				05
158	9E	LPF FC[7:0]								80
159	9F	CLM ANRSW								00
160	A0	CLM GC[7:0]								08
161	A1	CLM RMG[7:0]								80
162	A2	CLM RMB[7:0]								40
163	A3	CLM GMR[7:0]								80
164	A4	CLM GMB[7:0]								80
165	A5	CLM BMR[7:0]								40
166	A6	CLM BMG[7:0]								80
167	A7	MWB RG[7:0]								80
168	A8	MWB BG[7:0]								80
169	A9	ABB SW								07
170	AA									80
171	AB									00
172	AC									00
173	AD									00
174	AE									80
175	AF									00
176	B0									00
177	B1									80
178	B2	R BKL[7:0]								00
179	B3					R BKL[11:8]				08
180	B4	G BKL[7:0]								00
181	B5					G BKL[11:8]				08
182	B6	B BKL[7:0]								00
183	B7					B BKL[11:8]				08
184	B8	GAM SW[1:0]		GAM SCW[5:0]						FF
185	B9			GAM SCH[5:0]						00
186	BA			MCC RMG[5:0]						00
187	BB			MCC RMB[5:0]						00
188	BC			MCC GMR[5:0]						00
189	BD			MCC GMB[5:0]						00
190	BE			MCC BMR[5:0]						00
191	BF			MCC BMG[5:0]						00

The registers of gray mesh (unassigned registers) are not able to read and write via I²C bus.

“*” registers are read only.

Don't touch TESTMODE registers.

Address [Dec]	Address [Hex]	Data (D7)	(D6)	(D5)	(D4)	(D3)	(D2)	(D1)	(D0)	Initial [Hex]
192	C0	HDCVHSW				HDCVH_PC				88
193	C1	HDCVH_NC[7:0]								0F
194	C2	HDCVH_G[7:0]								40
195	C3	HDCHSW		HDCH_FS[1:0]		HDCH_PC				08
196	C4	HDCH_NC[7:0]								00
197	C5	HDCH_G[7:0]								00
198	C6	HDCMHSW		HDCMH_FS[2:0]		HDCMH_PC				08
199	C7	HDCMH_NC[7:0]								00
200	C8	HDCMH_G[7:0]								00
201	C9	VDC_PG[1:0]				VDC_PC				08
202	CA	VDC_NC[7:0]								0F
203	CB	VDC_G[7:0]								40
204	CC									36
205	CD	HDC_PL[7:0]								60
206	CE	VDC_PL[7:0]								60
207	CF	HDC_MG[7:0]								48
208	D0	VDC_MG[7:0]								60
209	D1									00
210	D2									00
211	D3	NEPO		Y_MATSW	DA_MODE					38
212	D4	UV_ACSSW		CONTRAST_R[5:0]						20
213	D5			CONTRAST_G[5:0]						20
214	D6			CONTRAST_B[5:0]						20
215	D7	CONTRAST_Y[7:0]								40
216	D8	SEPIA		BRIGHT_R[5:0]						10
217	D9			BRIGHT_G[5:0]						10
218	DA			BRIGHT_B[5:0]						10
219	DB	BRIGHT_Y[7:0]								90
220	DC		RMYA[6:0]							40
221	DD	RMYG[7:0]								B6
222	DE		BMYA[6:0]							40
223	DF	BMYG[7:0]								8F
224	E0		AVGSW	ZOOMMODE[5:0]						80
225	E1	ZHCORE[2:0]			ZHDTL[4:0]					88
226	E2	ZVCORE[2:0]			ZVDTL4:0]					88
227	E3									00
228	E4									80
229	E5									10
230	E6									00
231	E7									00
232	E8									00
233	E9	DYQTG[7:0]								10
234	EA	DUVQTG[7:0]								10
235	EB									00
236	EC									00
237	ED									00
238	EE			VQTSEL[1:0]		UQTSEL[1:0]		YQTSEL[1:0]		14
239	EF			VHTSELAC	VHTSELDC	UHTSELAC	UHTSELDC	YHTSELAC	YHTSELDC	3C
240	F0	DRI[15:8]								00
241	F1	DRI[7:0]								00
242	F2									00
243	F3									00
244	F4									00
245	F5									00
246	F6	ENCDCNT[23:16]								00
247	F7	ENCDCNT[15:8]								00
248	F8	ENCDCNT[7:0]								00
249	F9									00
250	FA	FULL_ERRN	ENC_ERRN							00
251	FB									00
252	FC									00
253	FD									00
254	FE									00
255	FF									00

The registers of gray mesh (unassigned registers) are not able to read and write via I²C bus.

“*” registers are read only.

Don't touch TESTMODE registers.

OUTLINE OF INTERNAL REGISTER

- * Frame rate setting (15ps, 7.5fps)
- * Picture size setting of digital output (4VGA, SXCA, VGA, QVGA, QQVGA, CIF, QCIF, subQCIF)
- * Selection of digital data output format (8bit YUV422, RGB565)
- * JPEG ON/OFF
- * Color signal adjustment (Carrier boost, Linear matrix, YUV matrix, saturation, etc.)
- * Luminance signal adjustment (Contrast, Brightness, Gamma, H,V edge enhancement)
- * ALC(Automatic Luminance level Control) ON/OFF
- * ALC mode setting (area selection, speed selection, flicker reduction mode setting)
- * AWB ON/OFF
- * Vertical and Horizontal flip
- * Standby mode setting
- * Some kinds of correction setting (Lens shading correction etc.)

8bit parallel image data

	YUV mode				RGB mode	
	1st	2nd	3rd	4th	1st	2nd
DOUT0	U0(n)	Y0(n)	V0(n)	Y0(n+1)	B0	G3
DOUT1	U1(n)	Y1(n)	V1(n)	Y1(n+1)	B1	G4
DOUT2	U2(n)	Y2(n)	V2(n)	Y2(n+1)	B2	G5
DOUT3	U3(n)	Y3(n)	V3(n)	Y3(n+1)	B3	R0
DOUT4	U4(n)	Y4(n)	V4(n)	Y4(n+1)	B4	R1
DOUT5	U5(n)	Y5(n)	V5(n)	Y5(n+1)	G0	R2
DOUT6	U6(n)	Y6(n)	V6(n)	Y6(n+1)	G1	R3
DOUT7	U7(n)	Y7(n)	V7(n)	Y7(n+1)	G2	R4

DATA OUTPUT TIMING CHART
 Timing chart for each output picture size

Full Mega output without JPEG

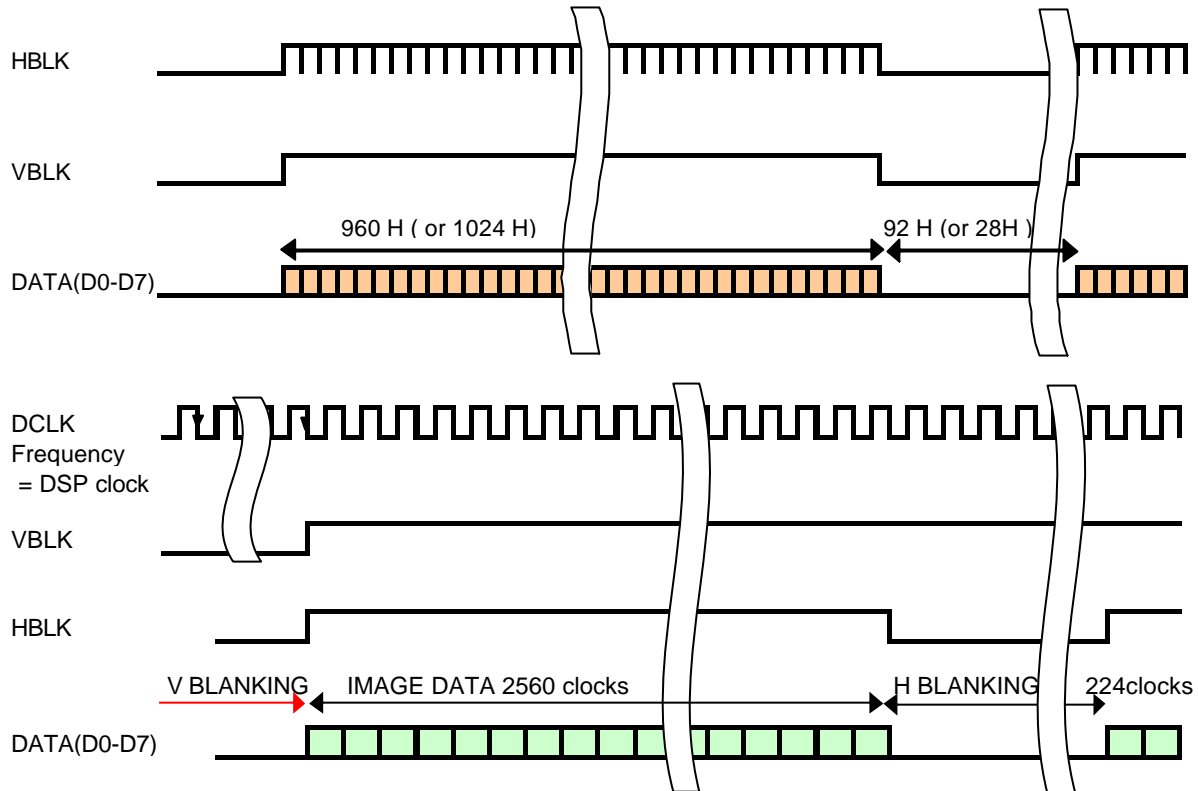

VGA (x1: no zooming)

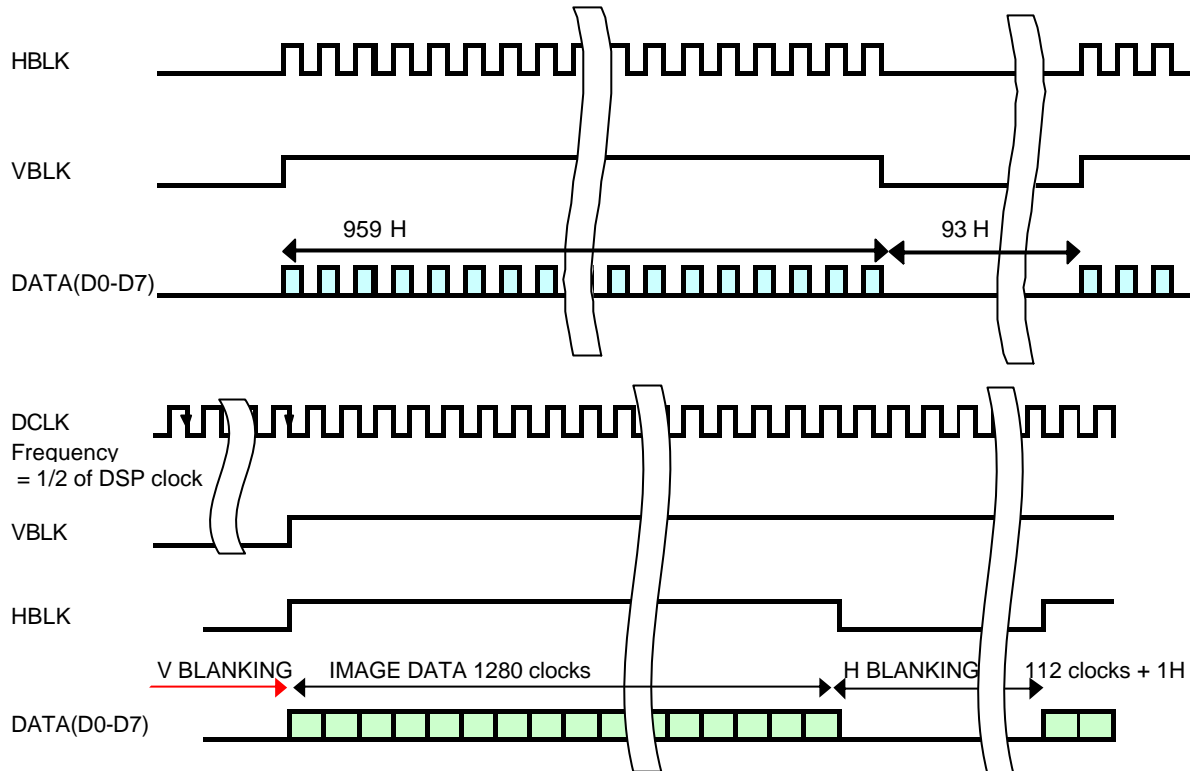

VGA (at maximum magnification x2)

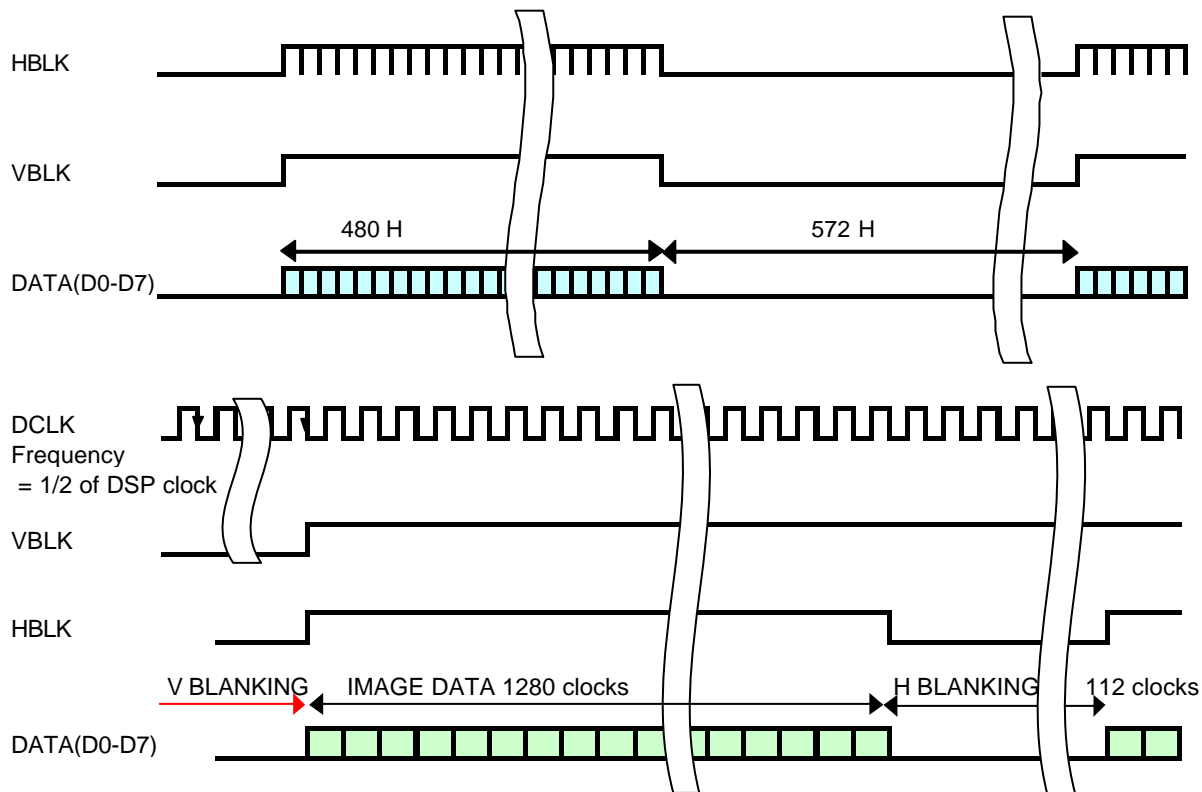

CIF (x1: no zooming)

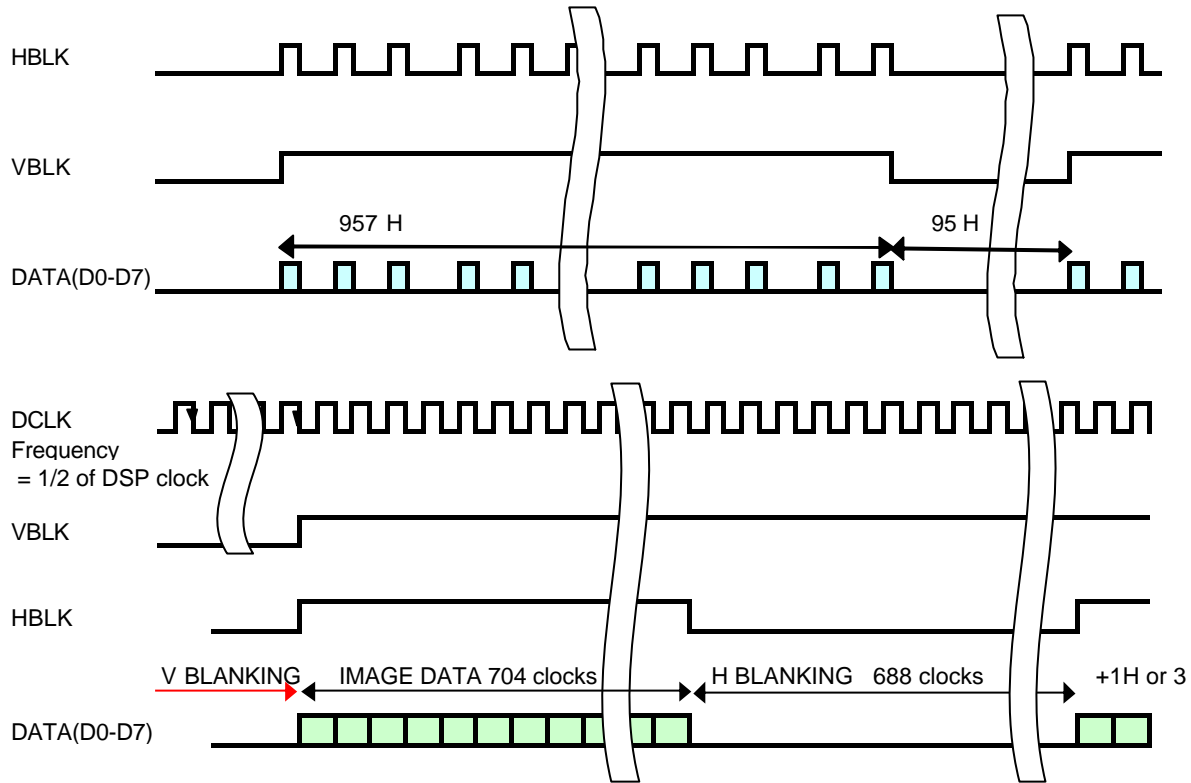

CIF (at maximum magnification)

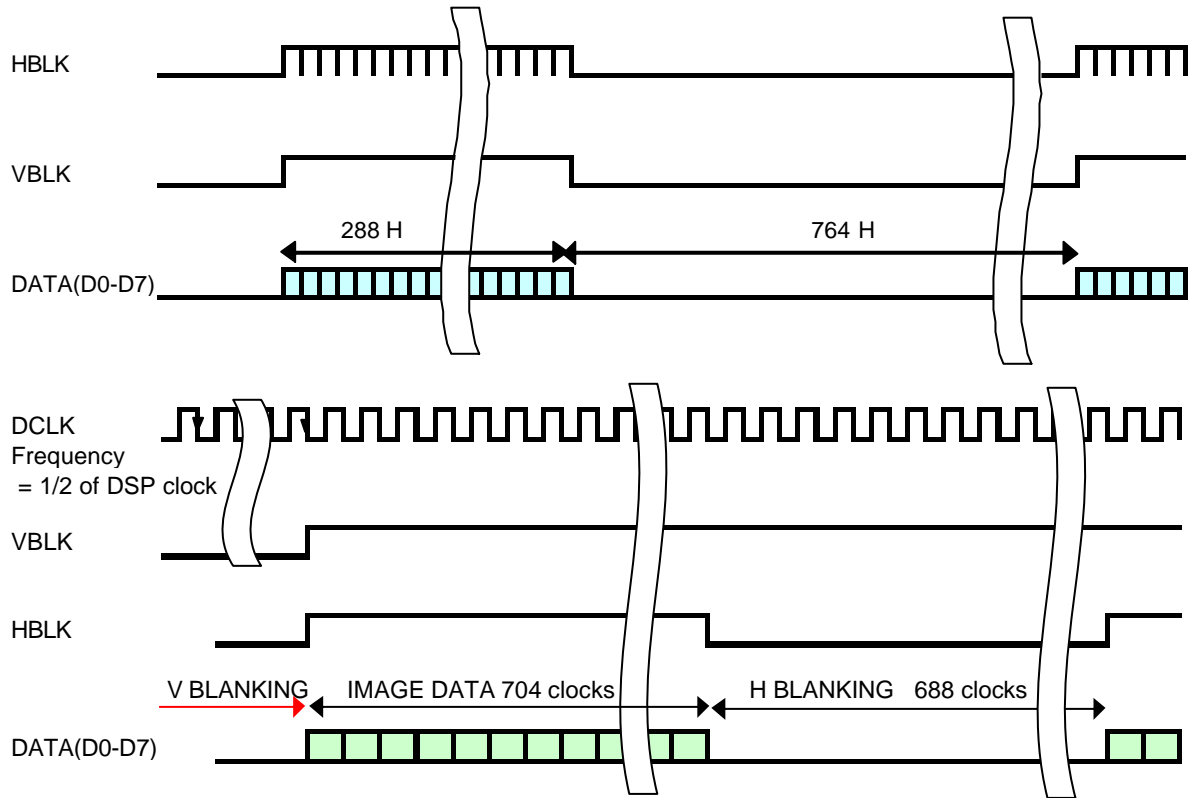

QVGA (x1: no digital zooming)

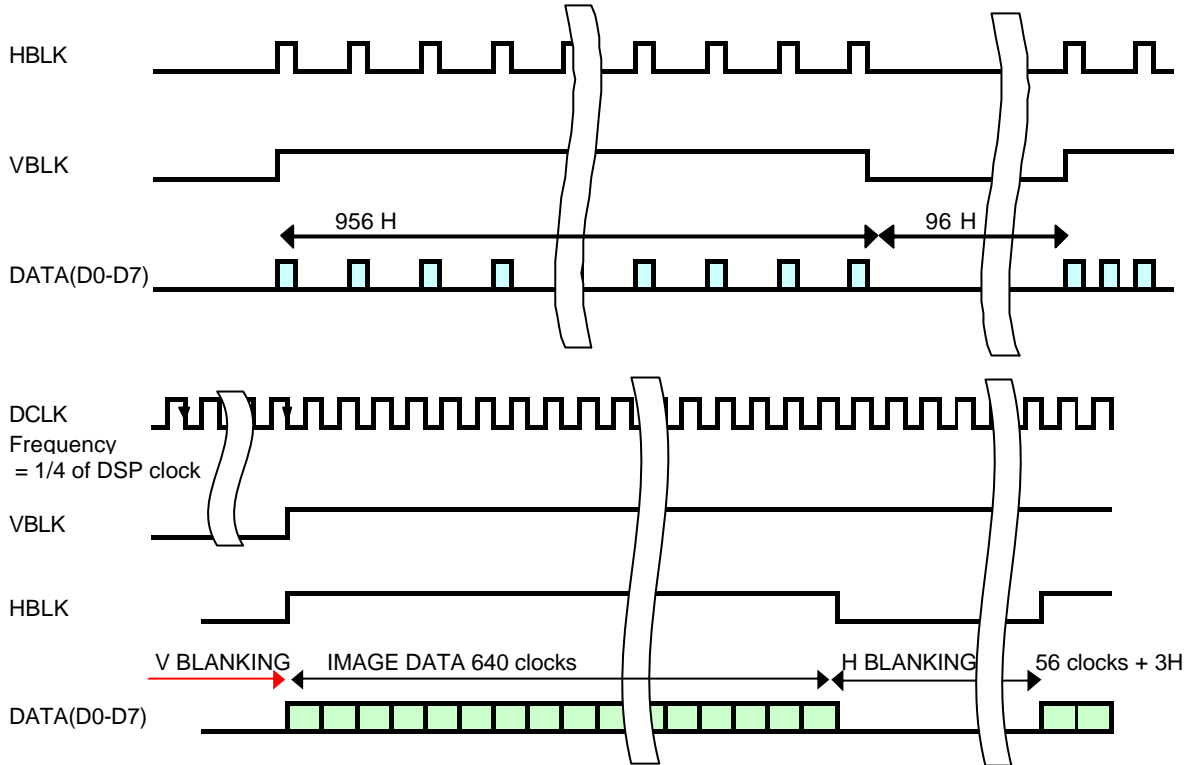

QVGA (at maximum magnification. X4)

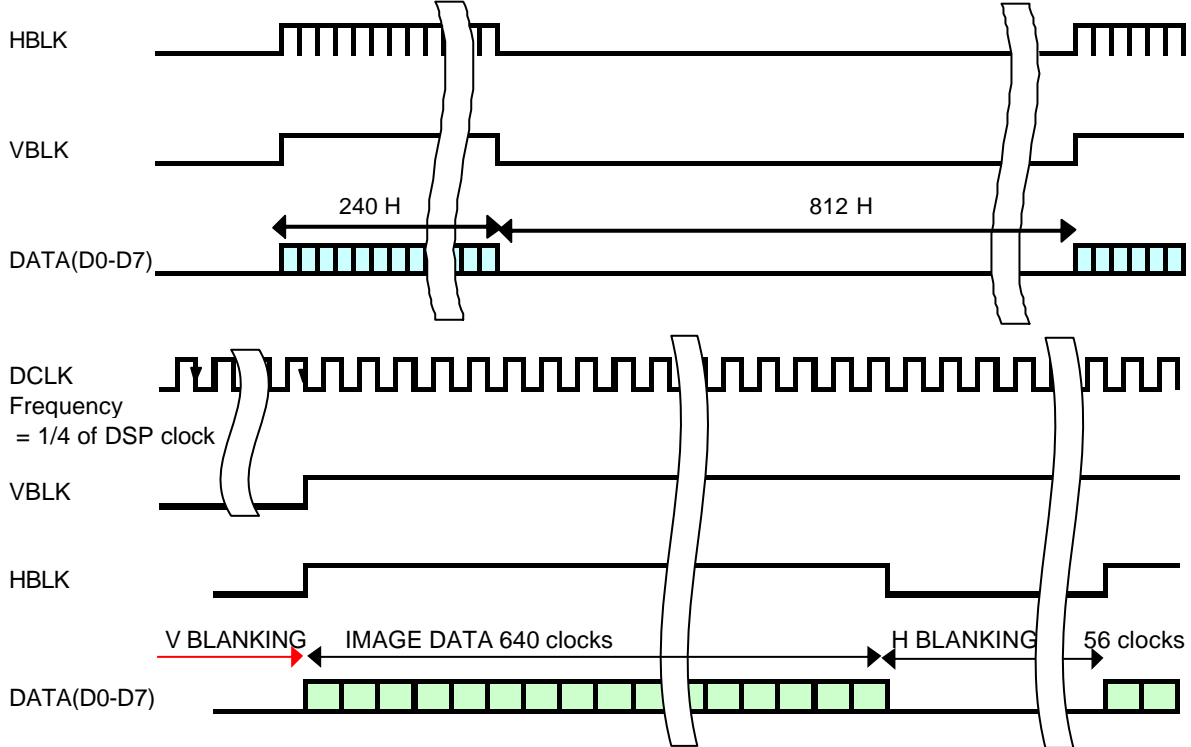

QCIF (x1: no digital zooming)

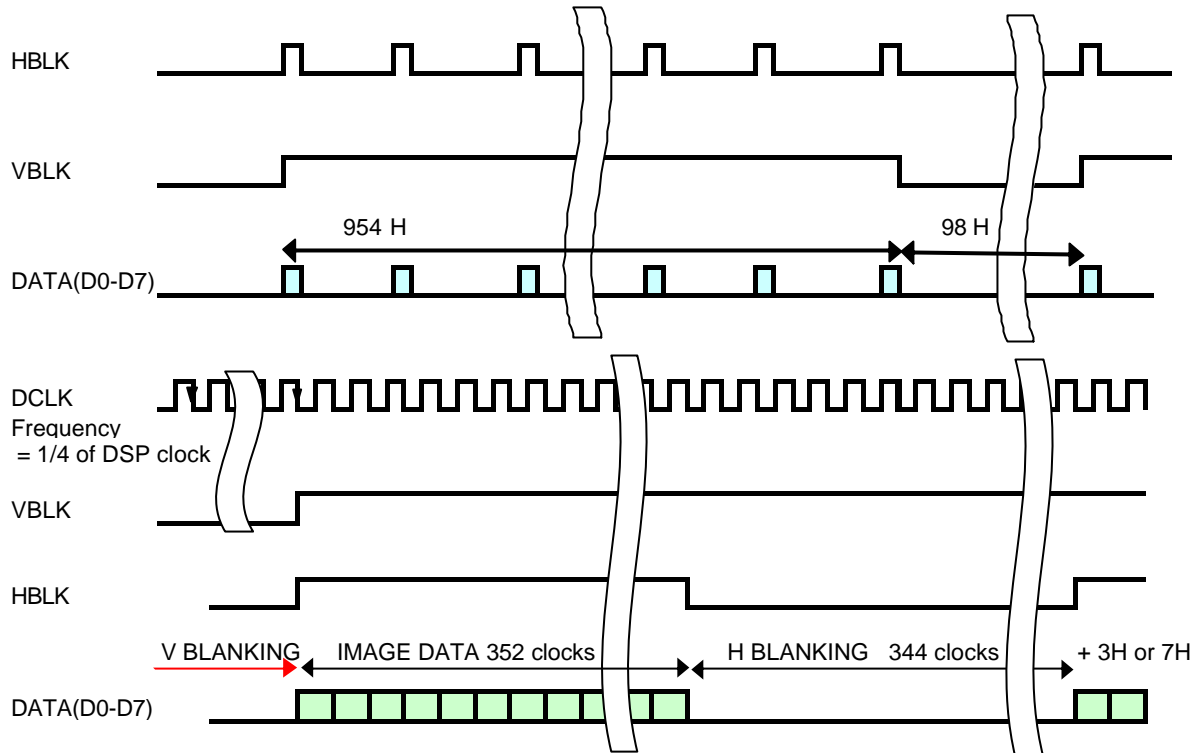

QCIF (at maximum magnification : x 6.67)

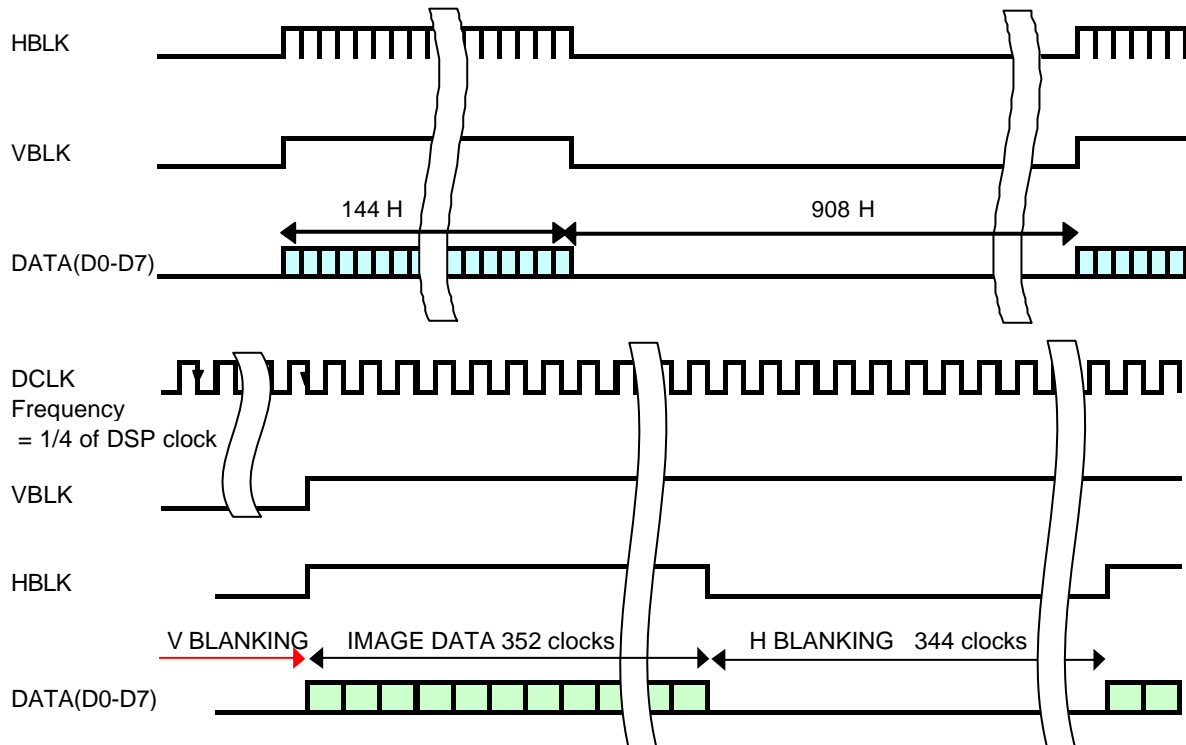

QQVGA (x1: no digital zooming)

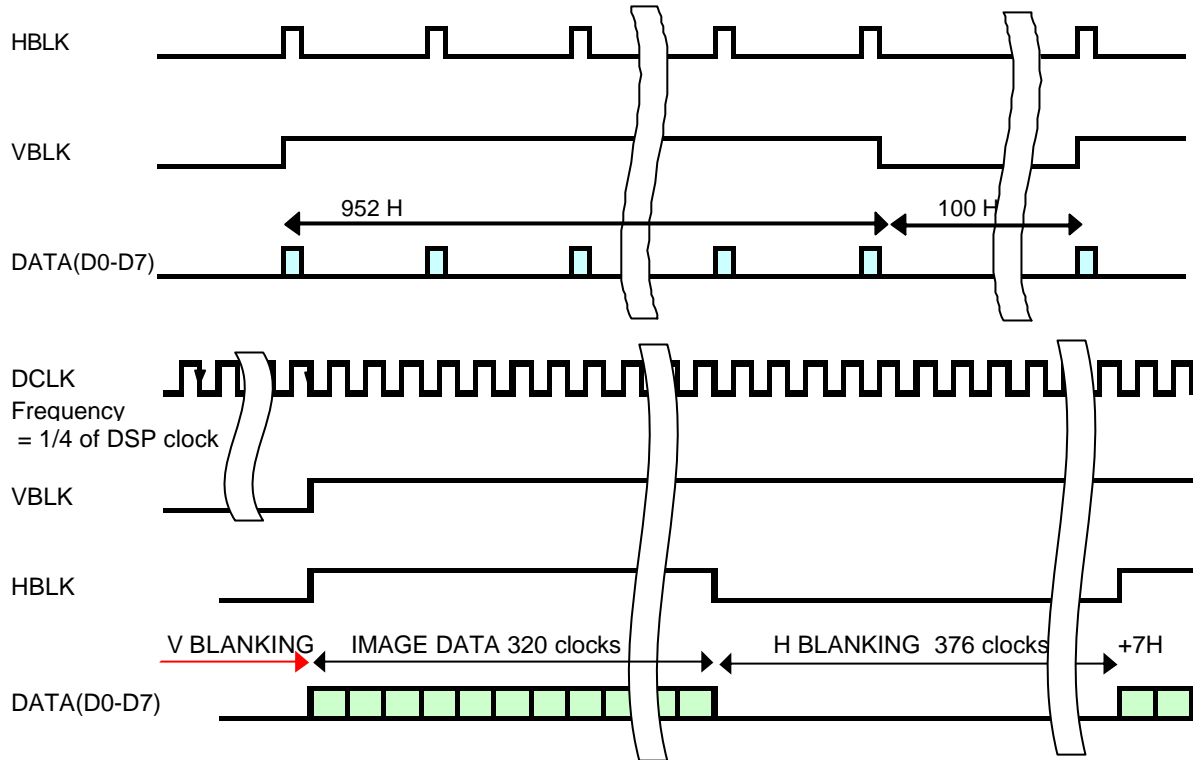

QQVGA (at maximum magnification: x 8)

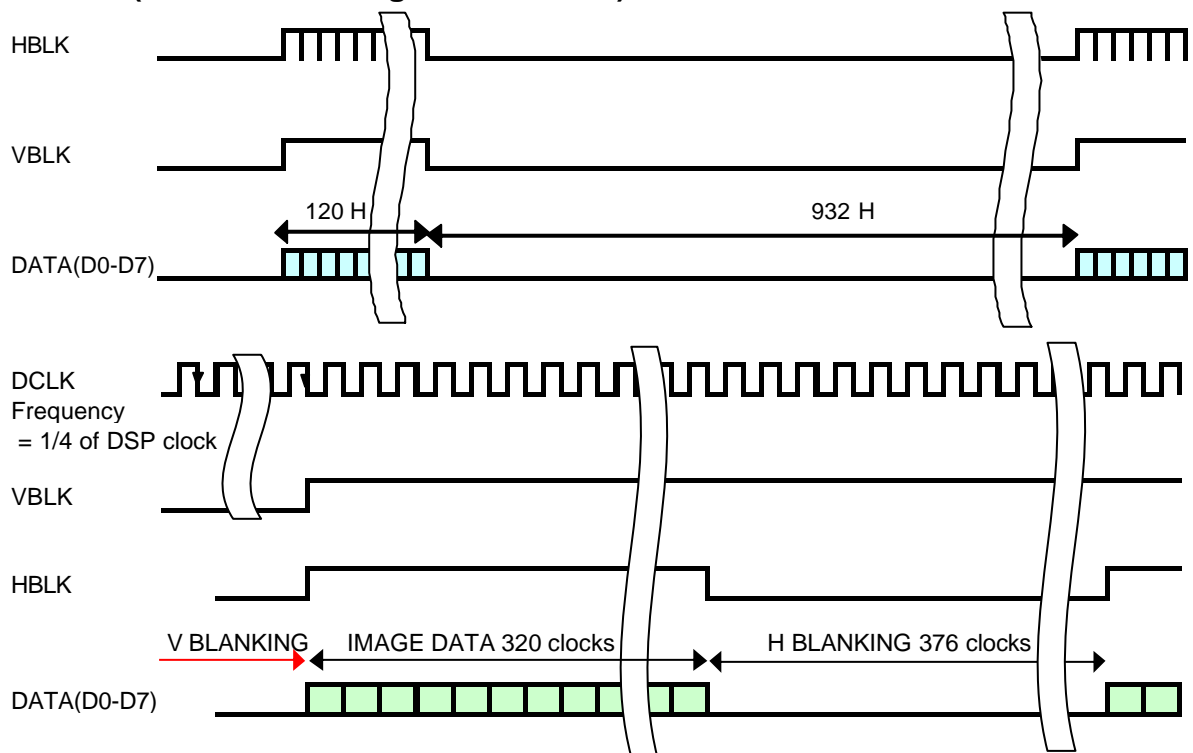

subQCIF (x1: no digital zooming)

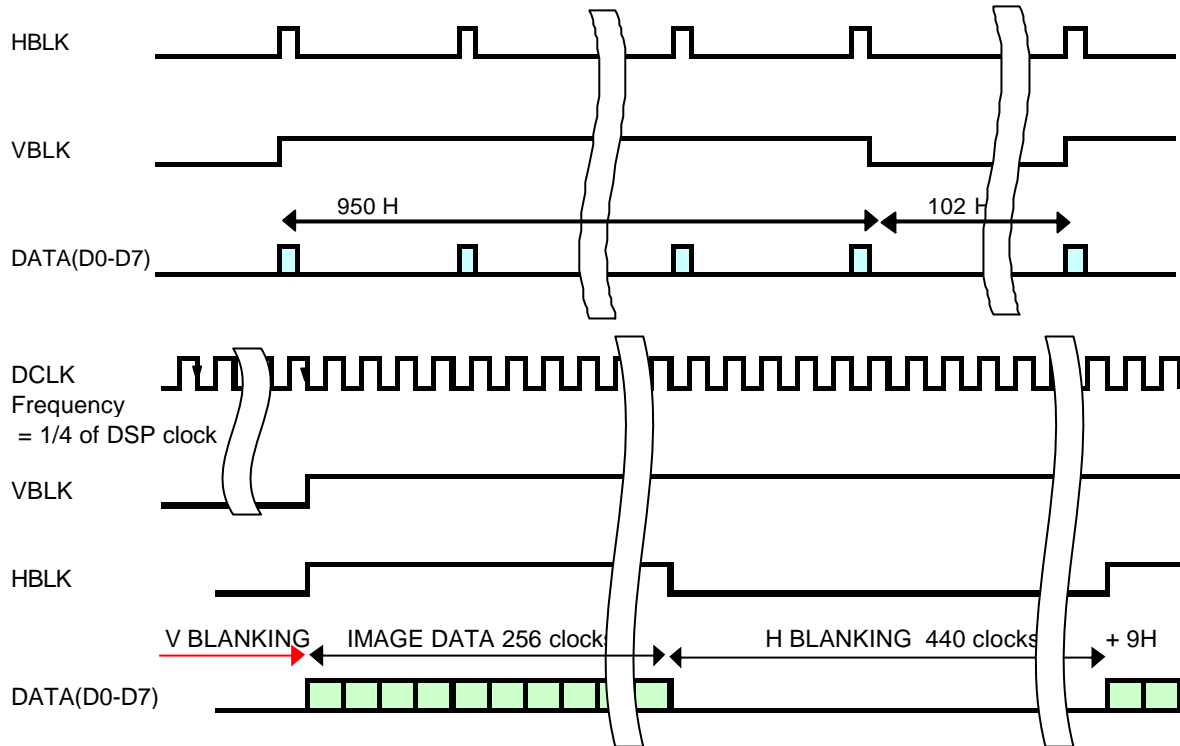

subQCIF (at maximum magnification: x 10)

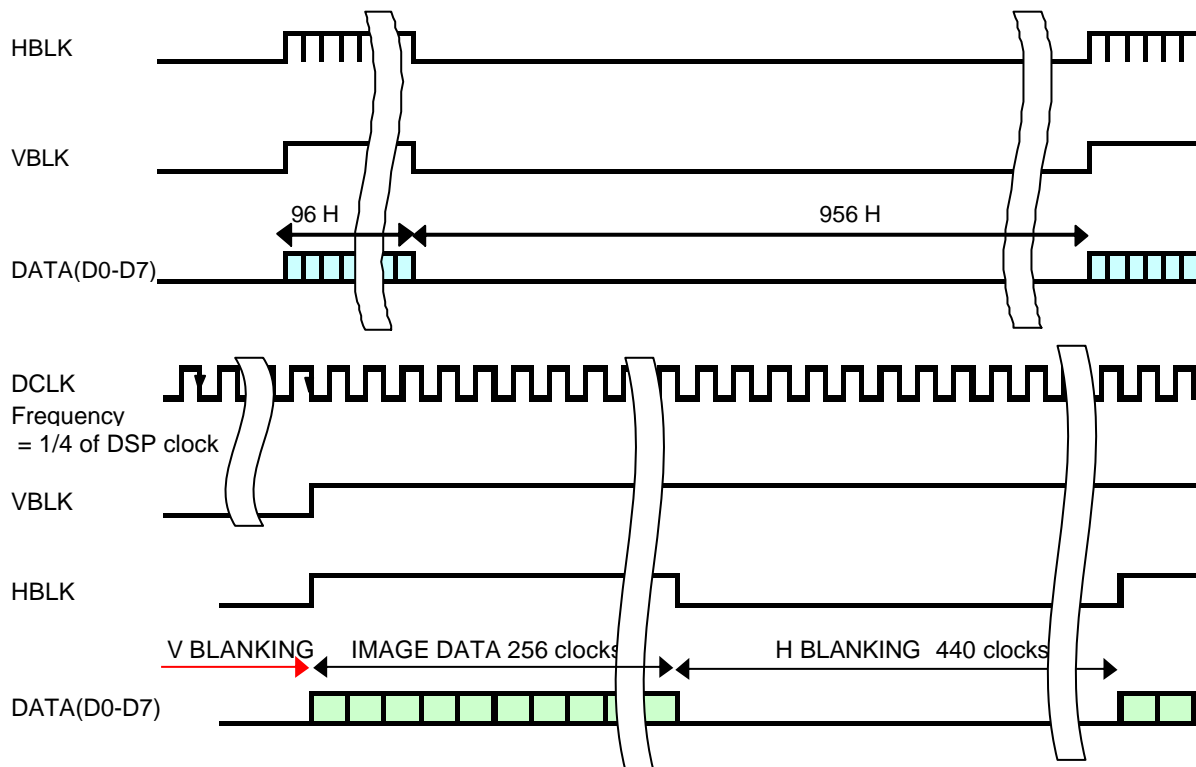

Remark: the downsized picture has generally intermittent output by line, but in a horizontal line the image data are put together to form a continuous stream.

JPEG encoded full Mega

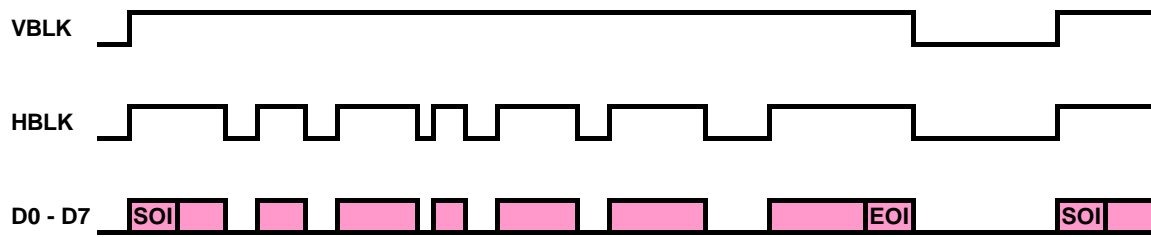

JPEG encoded data contains the standardized marker codes such as SOI and EOI. HBLK is set to high when JPEG data are output. The data length of one packet is multiple of MCU. It is using 8 lines buffer memories (FIFO) when JPEG encoding. It is limited for the writing not to surpass the reading because the writing speed is earlier than the reading speed. It is not limitation for low level period of HBLK. Also, following register setting, it is available to output by 4 bytes unit (multiple). HBLK is for data enable and high level period continues clock of 4 multiples. It is not limitation for low level period of HBLK. Also, when the JPEG data of 1V period is not 4 multiples, the data of address A5h makes to add after address FFh and address D9h because it needs to become 4 multiples.

* Setting of reading 4 bytes unit
 Address E6h D[3] J4BYTESW “High” setting: JPEG output by 4 bytes unit

JPEG DATA FORMAT

Block diagram

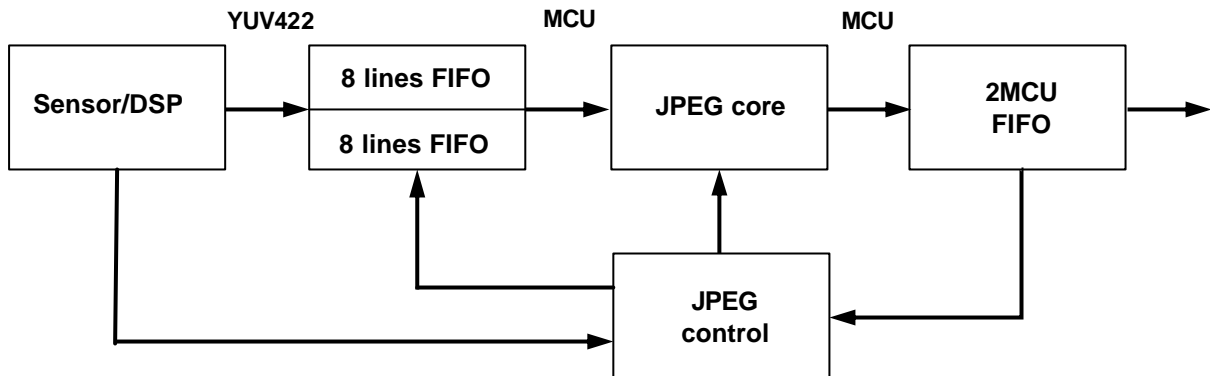

JPEG data structure

The following figure shows JPEG data structure.

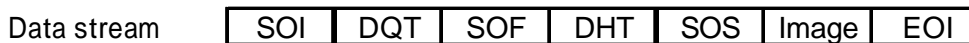

SOI	Marker code	16'hFFD8
DQT	Marker code	16'hFFDB
SOF	Marker code	16'hFFC0
DHT	Marker code	16'hFFC4
SOS	Marker code	16'hFFDA
Image data	MCU1 ~ MCU10240	(for 1280 × 1024 pixels)
EOI(16bit)	Marker code	16'hFFD9

The following tables show the data structure of DQT,SOF,DHT and SOS respectively.

The host can adjust the picture quality mode (namely compression ratio) by sending a specific quantization table or by sending Q table gain via IIC bus.

The JPEG encoded data are once stored an internal FIFO memory before outputting.

When data overflow in FIFO happens due to locally increased JPEG data (locally very low compression) , data transmission is stopped after FE code addition and an error flag is written in the register table.

After the host accesses the error flag register, the error flag is automatically reset.

DQT structure

	Code (Hex)	Meaning
+00	FF	Marker Prefix
+01	DB	DQT
+02	00	Length of field
	C5	$2+(1+64)*3=197$ (Byte)
+04	00	Y: Pq=0, Nq=0
+05	:	Quantization table Y : Q0
	:	:
	:	:
	:	:
	:	Quantization table Y : Q63
+45	01	U: Pq=0, Nq=1
+46	:	Quantization table U : Q0
	:	:
	:	:
	:	:
	:	Quantization table U : Q63
+86	02	V: Pq=0, Nq=0
+87	:	Quantization table V : Q0
	:	:
	:	:
	:	:
	:	Quantization table V : Q63

SOF structure

	Code (Hex)	Meaning
+00	FF	Marker Prefix
+01	C0	SOF
+02	00	Length of field
+03	C5	$2+1+2+1+2*3=17$ (Byte)
+04	00	Data precision (bits)
+05	XX	vertical lines
+06	YY	XXYY (Hex) lines
+07	WW	horizontal lines
+08	ZZ	WWZZ (Hex) lines
+09	03	Components
+0A	01	Components number (1:Y)
+0B	21	H0=2, V0=1(4:2:2)
+0C	00	Quantization designation
+0D	02	Components number (2:U)
+0E	11	H1=1, V1=1
+0F	01	Quantization designation
+10	03	Components number (2:U)
+11	11	H2=1, V2=1
+13	02	Quantization designation

DHT structure

	Code (Hex)	Meaning
+00	FF	Marker Prefix
+01	C4	DHT
+02	01	Length of field
	A2	$2+(1+16+12+1+16+162)*2=418$ (Byte)
+04	00	Table number Y-DC : 00
		DHT parameter
	10	Table number Y-AC : 10
		DHT parameter
	01	Table number C-DC : 01
		DHT parameter
	11	Table number C-AC : 11
		DHT parameter
	00	Table number Y-DC : 00
		DHT parameter
	10	Table number Y-AC : 10
		DHT parameter
	01	Table number C-DC : 01
		DHT parameter
	11	Table number C-AC : 11
		DHT parameter

Remark : the current JPEG logic core outputs two sets of Huffmann table.

SOS structure

	Code (Hex)	Meaning
+00	FF	Marker Prefix
+01	DA	SOS
+02	00	Length of field
	0C	$2+1+3*2+3=12$ (Byte)
+04	03	Components in scan
+05	01	Components selector Y:01
+06	00	Huffmann table selector Y:00
+07	02	Components selector U:02
+08	11	Huffmann table selector C:11
+09	03	Components selector V:03
+0A	11	Huffmann table selector C:11
+0B	00	Scan start position in block
+0C	3F	Scan end position in block
+0D	00	Successive approximation Bit position

OPERATING FLOW

The sensor chip supports the operating mode and the standby mode as shown in the following figure.

power management

In power off mode, the output pins are not in High-Z status.

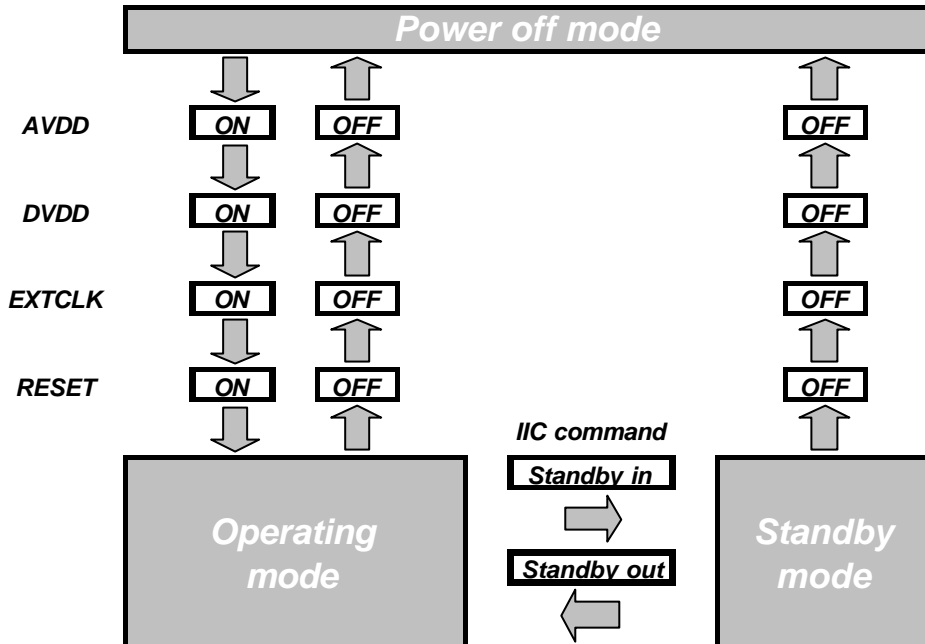

In standby mode, the latest status of output pins is restored. If the host sends "Lowfixed" command before sleep command, all the output pins are set to "Low".

Powering order and timing margin are shown in the following figure.

Timing description in power sequence

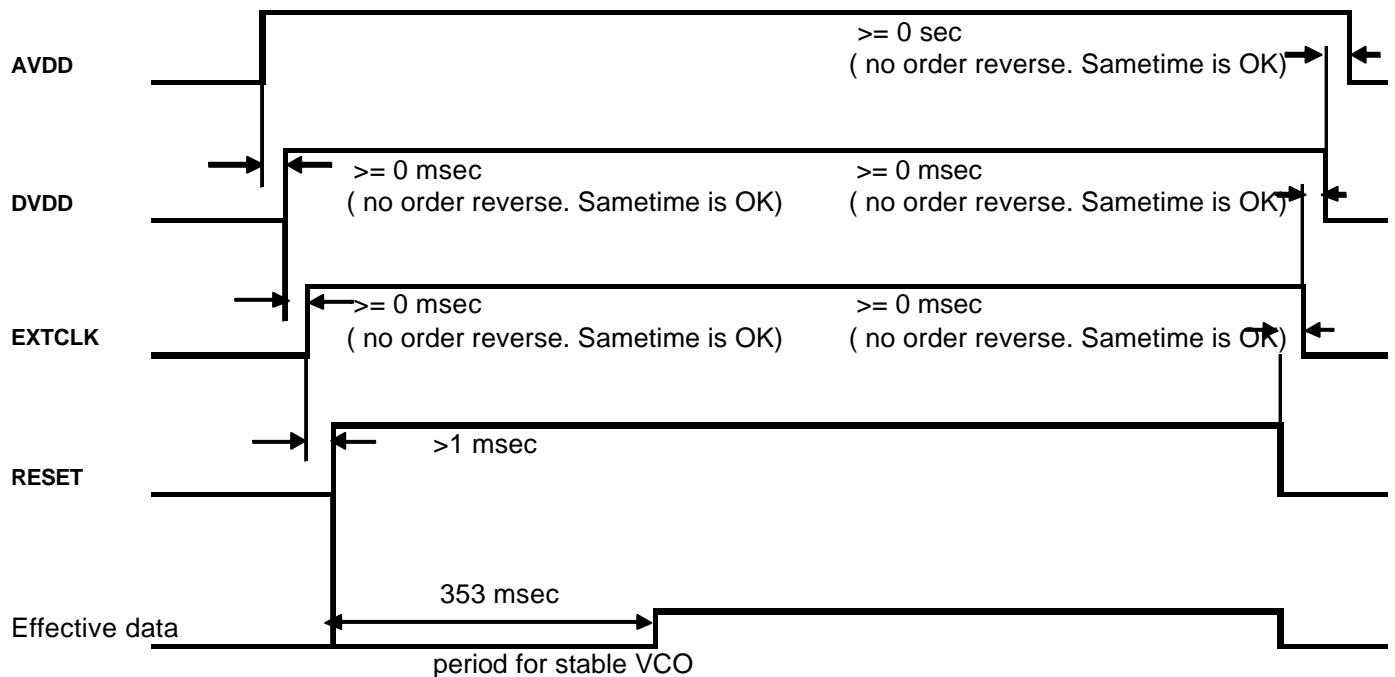

When 1.6V power line is higher than 2.5V power line, the current is provided from 1.6V power line to 2.5V power line via internal protection diode.

When 2.5V power line is open, the current is provided to 2.5V power line from 1.6V power line via internal protection diode. Then 1V is provided at 2.5V power line and 1.6V is provided at 1.6V power line.

When 2.5V power line is connected to GND, 1.6V power line is shorted to GND at low impedance.

These conditions can not be guaranteed and it need to consideration to design.

Acceptable period for command setting

The following figure shows the command acceptable period. In general the status of the next frame data is immediately reflected by the command, but in case of the commands dealing with sensor operation such as exposure time setting, the frame after next is reflected. Register setting is available between top of full mega pixel image and end of image.

The minimum period happens in case of sub QCIF maximum zooming. The command acceptable period after VBLK turns high is 36 msec for 15 fps operation and 71.5 msec for 7.5fps.

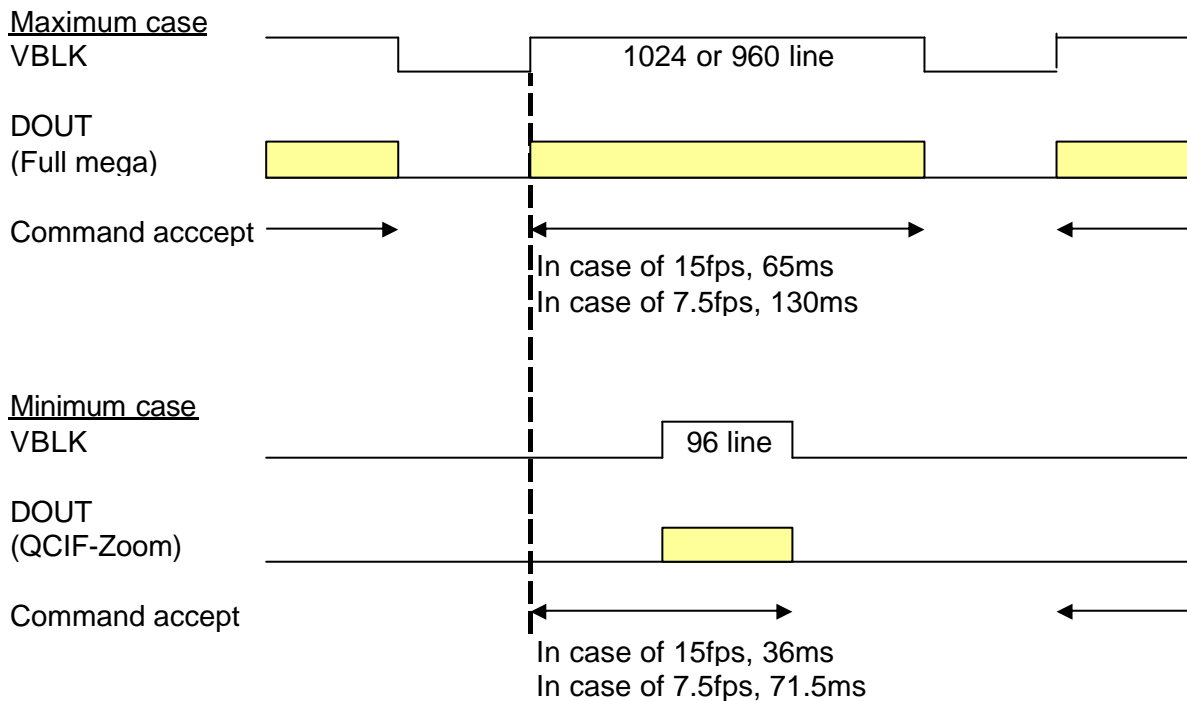

MAXIMUM RATING

CHARACTERISTICS	SYMBOL	RATING	UNITS
Power supply voltage	PVDD (AVDD25), IOVDD (IOVDD25, IOAVD25)	-0.3 to 3.6	V
	DVDD (AVDD15, DVDD15)	-0.3 to 3.0	V
Input voltage	V_{IN}	-0.3 to VDD+0.3	V
Storage temperature	T_{stg}	-30 to 85	Degree C

RECOMMENDED OPERATION CONDITION

CHARACTERISTICS	SYMBOL	MIN	TYP	MAX	UNITS
Power supply voltage	PVDD (AVDD25), IOVDD (IOVDD25, IOAVDD25)	2.6	2.8	3.0	V
		2.3	2.5	2.7	V
	DVDD (AVDD15, DVDD15)	1.5	1.6	1.7	V
Input voltage	V_{IN}	0 to VDD			V
Operating temperature	T_{OPR}	-20 to 60			Degree C

Note;

* If using 2.5V operation, must input setting command. (Default setting is 2.8V operation.)

ELECTRICAL CHARACTERISTICS

DC Characteristics (Ta=25 degree C, PVDD=IOVDD=2.8V, DVDD=1.6V)

1. POWER CONSUMPTION

(Ta=25 degree C, PVDD=IOVDD=2.5V, DVDD=1.6V, 15fps operation, dark condition)

ITEM		CONDITION		MIN	TYP	MAX	UNITS
POWER *	IOVDD, PVDD	Normal mode	Output data: YUV	-	20	30	mA
	DVDD			-	100	150	mA
	IOVDD, PVDD		Output data: JPEG *	-	10	15	mA
	DVDD			-	90	140	mA
	IOVDD, PVDD	Standby mode	Ta=60 degree C	-	-	11	μA
	DVDD			-	-	5100	μA

Note;

* Measurement condition: Machbeth chart(full)

* JPEG table is standard.

2. EXTCLK

ITEM		SYMBOL	CONDITION	MIN	TYP	MAX	UNITS
Rectangular shape	HIGH level input voltage	V _{IH} EXTCLK	-	IOVDD x 0.8	-	-	V
	LOW level input voltage	V _{IL} EXTCLK	-	-	-	IOVDD x 0.2	V
	HIGH level input current	I _{IH} EXTCLK	V _{IN} =IOVDD	-10	-	10	μA
	LOW level input current	I _{IL} EXTCLK	V _{IN} =GND	-10	-	10	μA
	DUTY *	-	-	45/55	-	55/45	%

Note;

* Duty is referred to 50% level of input EXTCLK.

3. SCL, SDA

ITEM		SYMBOL	CONDITION	MIN	TYP	MAX	UNITS
SCL	HIGH level input voltage	V _{IH} SCL	-	IOVDD x 0.7	IOVDD	3.3	V
	LOW level input voltage	V _{IL} SCL	-	0	-	IOVDD x 0.3	V
SDA	HIGH level input voltage	V _{IH} SDA	-	IOVDD x 0.7	IOVDD	3.3	V
	LOW level input voltage	V _{IL} SDA	-	0	-	IOVDD x 0.3	V
	LOW level output voltage	V _{OL} SDA	I _{OL} =4mA	0	-	0.4	V

4. DOUT7-0, HBLK, VBLK, STROBE, DCLK

ITEM		SYMBOL	CONDITION	MIN	TYP	MAX	UNITS
DOUT7-0, HBLK, VBLK, STROBE, DCLK	HIGH level output voltage	V _{OH} DATA	I _{OH} =-2mA	2.4	IOVDD	-	V
	LOW level output voltage	V _{OL} DATA	I _{OL} =2mA	0	-	0.4	V

5. RESET

ITEM		SYMBOL	CONDITION	MIN	TYP	MAX	UNITS
RESET	HIGH level input voltage	V _{IH} RESET	-	IOVDD x 0.8	-	-	V
	LOW level input voltage	V _{IL} RESET	-	-	-	IOVDD x 0.2	V
	HIGH level input current	I _{IH} RESET	V _{IN} =GND	-10	-	10	μA
	LOW level input current	I _{IL} RESET	V _{IN} =IOVDD	-10	-	10	μA

AC Characteristics (Ta=25 degree C, PVDD=IOVDD=2.8V, DVDD=1.6V)

1. EXTCLK

ITEM	SYMBOL	MIN	TYP	MAX	UNITS	NOTE
Clock frequency	f_{EXTCLK}	6	-	20	MHz	
Rise time	$t_{rEXTCLK}$	-	-	5	ns	* 1
Fall time	$t_{fEXTCLK}$	-	-	5	ns	

Note;

ALL values referred to V_{IHmin} and V_{ILmax} levels.

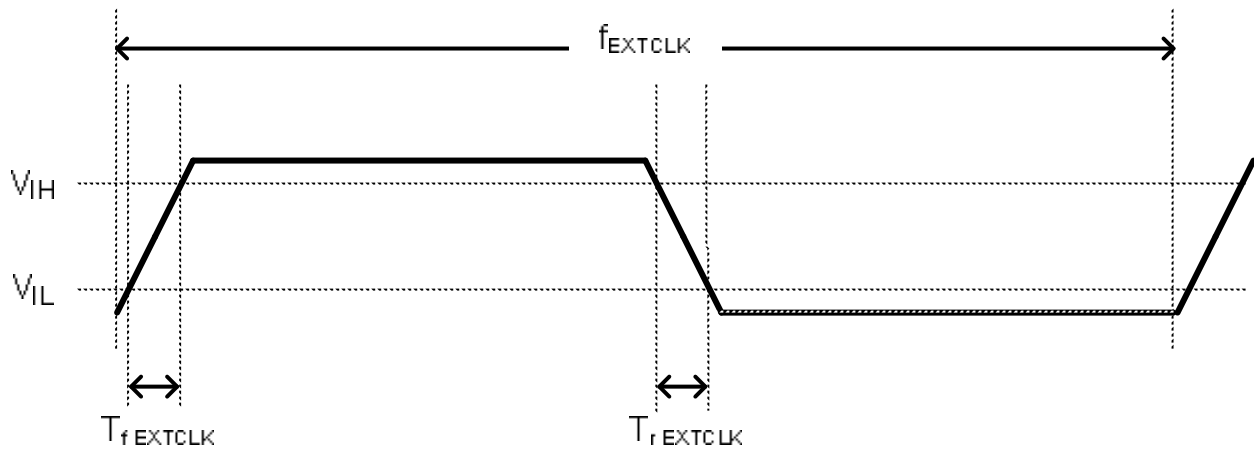

2. SCL, SDA

ITEM		SYMBOL	MIN	MAX	UNITS	NOTE
SCL	Clock frequency	f_{SCL}	0	400	kHz	*1
	Low period	$t_{LOW\ SCL}$	1.3	-	μs	
	High period	$t_{HIGH\ SCL}$	0.6	-	μs	
	Rise time	$t_r\ SCL$	-	300	μs	
	Fall time	$t_f\ SCL$	-	300	μs	
SDA	Rise time	$t_r\ SDA$	-	300	μs	
	Fall time	$t_f\ SDA$	-	300	μs	
Hold time (repeated) START condition After this period, the first clock pulse is generated		$t_{HD\ STA}$	0.6	-	μs	
Setup time for a repeated START condition		$t_{SU\ STA}$	0.6	-	μs	
Data hold time		$t_{HD\ DAT}$	0	-	μs	
Data setup time		$t_{SU\ DAT}$	100	-	μs	
Setup time for STOP condition		$t_{SU\ STO}$	0.6	-	μs	
Width of spike pulse	Normal	t_{SP1}	0	50	μs	
	Wakeup from sleep mode	t_{SP2}	0	20	μs	

Note;

* All values referred to V_{IHmin} and V_{ILmax} levels.

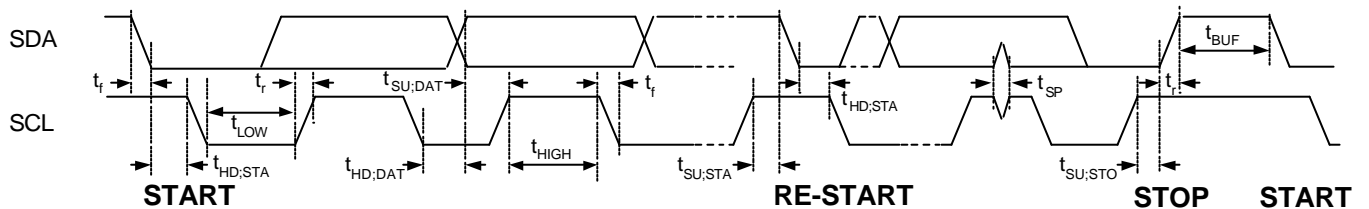

3. DOUT7-0, DCLK, HBLK, VBLK

ITEM	SYMBOL	MIN	MAX	UNITS	NOTE
DCLK	Rise time	$t_{r\text{DCLK}}$	-	6	μs
	Fall time	$t_{f\text{DCLK}}$	-	6	μs
DOUT7-0, HBLK, VBLK	Rise time	$t_{r\text{DATA}}$	-	6	μs
	Fall time	$t_{f\text{DATA}}$	-	6	μs
Data hold time	$t_{\text{HD DATA}}$	10	-	μs	
Data setup time	$t_{\text{SU DATA}}$	10	-	μs	

Note;

* All values referred to V_{OHmin} and V_{OLmax} levels.

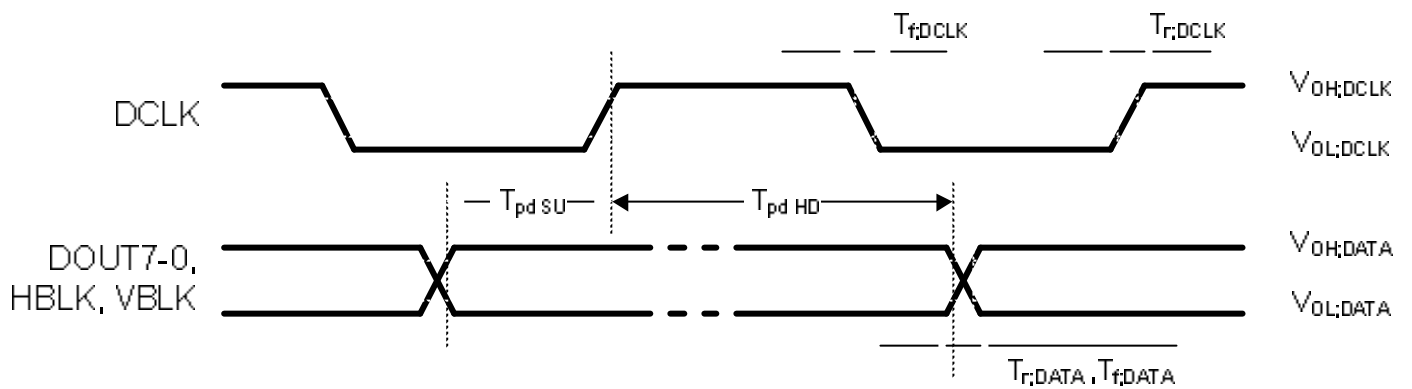

Reference Drawing

Module shape is not finalized yet in detail. Following drawings are only reference for initial study.

