

TD62003FB, TD62004FB

7CH DARLINGTON SINK DRIVER

The TD62003FB series are high-voltage, high-current darlington drivers comprised of seven NPN darlington pairs. All units feature integral clamp diodes for switching inductive loads.

Applications include relay, hammer, lamp and display (LED) drivers.

Please observe the thermal condition for using.

FEATURES

- Output current (single output) : 500 mA / ch (Max)
- High sustaining voltage output : 35 V (Min)
- Output clamp diodes
- Inputs compatible with various types of logic.
 TD62003FB : $R_{IN} = 2.7\text{ k}\Omega$
 TD62004FB : $R_{IN} = 10.5\text{ k}\Omega$
- Package SOP-16 pin

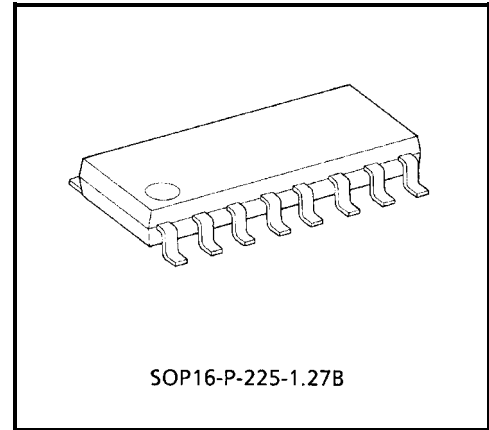

Weight: 0.16 g (Typ.)

PIN CONNECTION (TOP VIEW)

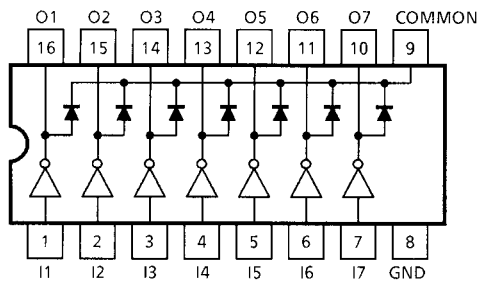

SCHEMATICS (EACH DRIVER)

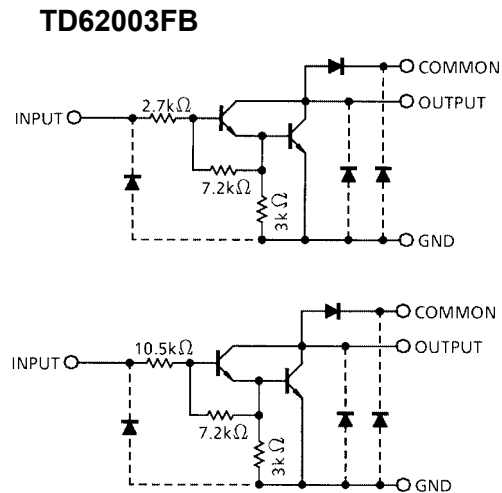

Note: The input and output parasitic diodes cannot be used as clamp diodes.

MAXIMUM RATINGS (Ta = 25°C)

CHARACTERISTIC	SYMBOL	RATING	UNIT
Output Sustaining Voltage	V _{CE (SUS)}	-0.5~35	V
Output Current	I _{OUT}	500	mA / ch
Input Voltage	V _{IN}	-0.5~30	V
Clamp Diode Reverse Voltage	V _R	35	V
Clamp Diode Forward Current	I _F	500	mA
Power Dissipation	P _D	0.54 / 0.625 (Note)	W
Operating Temperature	T _{opr}	-40~85	°C
Storage Temperature	T _{stg}	-55~150	°C

Note: On Glass Epoxy PCB (30 × 30 × 1.6 mm Cu 50%)

RECOMMENDED OPERATING CONDITIONS (Ta = -40~85°C)

CHARACTERISTIC		SYMBOL	CONDITION	MIN	TYP.	MAX	UNIT	
Output Sustaining Voltage		V _{CE (SUS)}	—	0	—	35	V	
Output Current		I _{OUT}	DC 1 Circuit	0	—	350	mA / ch	
			T _{pw} = 25 ms T _j = 120°C 7 Circuits Ta = 85°C	Duty = 10%	0	—		275
				Duty = 50%	0	—		90
Input Voltage		V _{IN}	—	0	—	24	V	
Input Voltage (Output On)	TD62003	V _{IN (ON)}	I _{OUT} = 400 mA, h _{FE} = 800	2.8	—	24	V	
	TD62004			6.2	—	24		
Input Voltage (Output Off)	TD62003	V _{IN (OFF)}	—	0	—	0.7	V	
	TD62004			0	—	1.0		
Clamp Diode Reverse Voltage		V _R	—	—	—	35	V	
Clamp Diode Forward Current		I _F	—	—	—	350	mA	
Power Dissipation		P _D	Ta = 85°C (Note)	—	—	0.325	W	

Note: On Glass Epoxy PCB (30 × 30 × 1.6 mm Cu 50%)

ELECTRICAL CHARACTERISTICS (Ta = 25°C)

CHARACTERISTIC	SYMBOL	TEST CIR-CUIT	TEST CONDITION	MIN	TYP.	MAX	UNIT	
Output Leakage Current	I _{CEX}	1	V _{CE} = 35 V, Ta = 25°C	—	—	50	μA	
			V _{CE} = 35 V, Ta = 85°C	—	—	100		
Collector-Emitter Saturation Voltage	V _{CE (sat)}	2	I _{OUT} = 350 mA, I _{IN} = 500 μA	—	1.3	1.6	V	
			I _{OUT} = 200 mA, I _{IN} = 350 μA	—	1.1	1.3		
			I _{OUT} = 100 mA, I _{IN} = 250 μA	—	0.9	1.1		
DC Current Transfer Ratio	h _{FE}	2	V _{CE} = 2 V, I _{OUT} = 350 mA	1000	—	—		
Input Current (Output On)	I _{IN (ON)}	3	V _{IN} = 2.4 V, I _{OUT} = 350 mA	—	0.4	0.7	mA	
			V _{IN} = 9.5 V, I _{OUT} = 350 mA	—	0.8	1.2		
Input Current (Output Off)	I _{IN (OFF)}	4	I _{OUT} = 500 μA, Ta = 85°C	50	65	—	μA	
Input Voltage (Output On)	V _{IN (ON)}	5	V _{CE} = 2 V h _{FE} = 800	I _{OUT} = 350 mA	—	—	2.6	V
				I _{OUT} = 200 mA	—	—	2.0	
				I _{OUT} = 350 mA	—	—	4.7	
				I _{OUT} = 200 mA	—	—	4.4	
Clamp Diode Reverse Current	I _R	6	V _R = 35 V, Ta = 25°C	—	—	50	μA	
			V _R = 35 V, Ta = 85°C	—	—	100		
Clamp Diode Forward Voltage	V _F	7	I _F = 350 mA	—	—	2.0	V	
Input Capacitance	C _{IN}	8	—	—	15	—	pF	
Turn-On Delay	t _{ON}	9	V _{OUT} = 35 V, R _L = 87.5 Ω C _L = 15 pF	—	0.1	—	μs	
Turn-Off Delay	t _{OFF}	9	V _{OUT} = 35 V, R _L = 87.5 Ω C _L = 15 pF	—	0.2	—		

TEST CIRCUIT

1. I_{CEX}

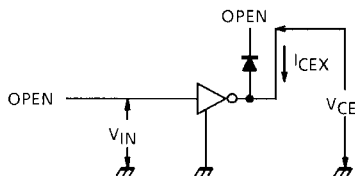

2. V_{CE (sat)}, h_{FE}

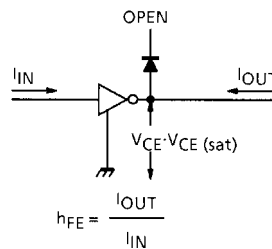

3. I_{IN (ON)}

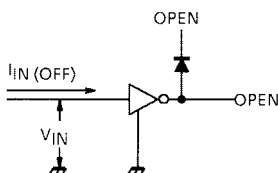

4. I_{IN (OFF)}

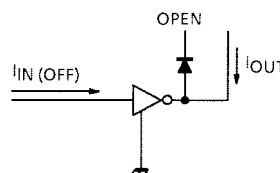

5. $V_{IN(ON)}$

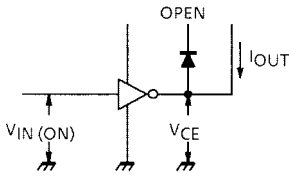

6. I_R

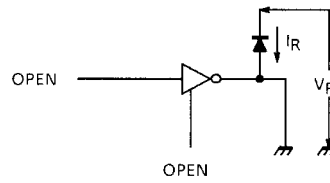

7. V_F

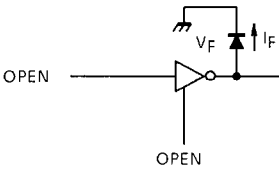

8. t_{ON}, t_{OFF}

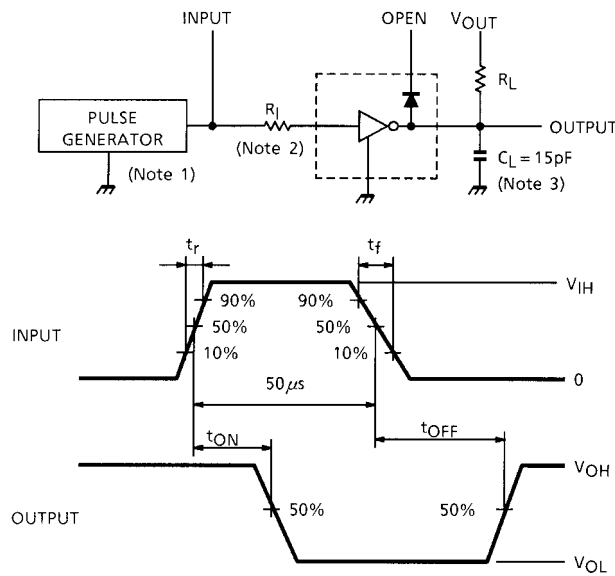

Note 1: Pulse Width 50 μ s, Duty Cycle 10%
Output Impedance 50 Ω , $t_r \leq 5$ ns, $t_f \leq 10$ ns

Note 2: See below.

INPUT CONDITION

TYPE NUMBER	R_I	V_{IH}
TD620003FB	0	3 V
TD620004FB	0	8 V

Note 3: C_L includes probe and jig capacitance.

PRECAUTIONS for USING

This IC does not include built-in protection circuits for excess current or overvoltage.

If this IC is subjected to excess current or overvoltage, it may be destroyed.

Hence, the utmost care must be taken when systems which incorporate this IC are designed.

Utmost care is necessary in the design of the output line, COMMON and GND line since IC may be destroyed due to short-circuit between outputs, air contamination fault, or fault by improper grounding.

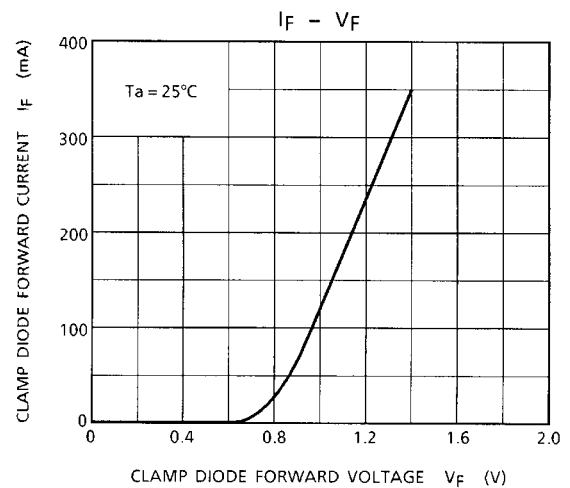
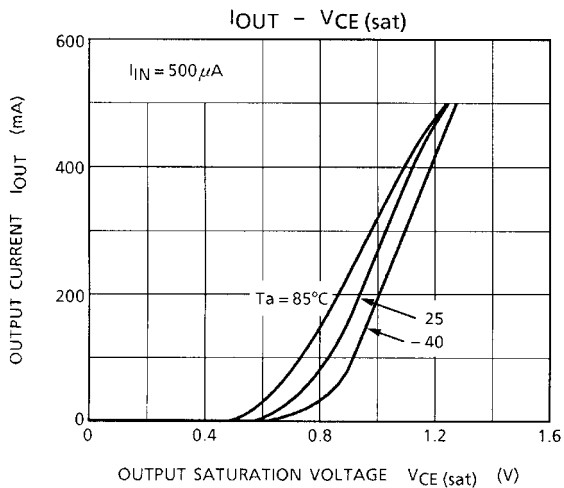
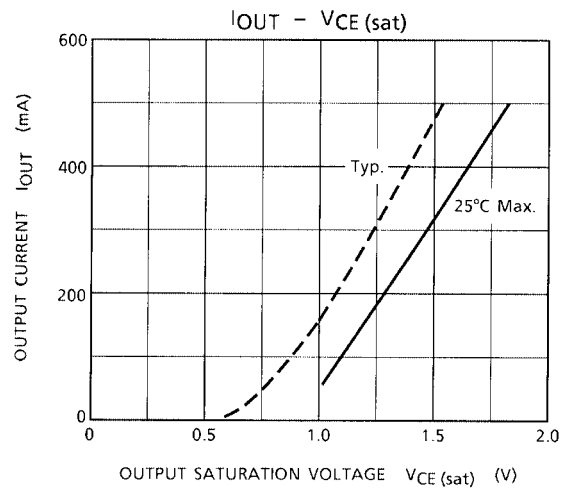
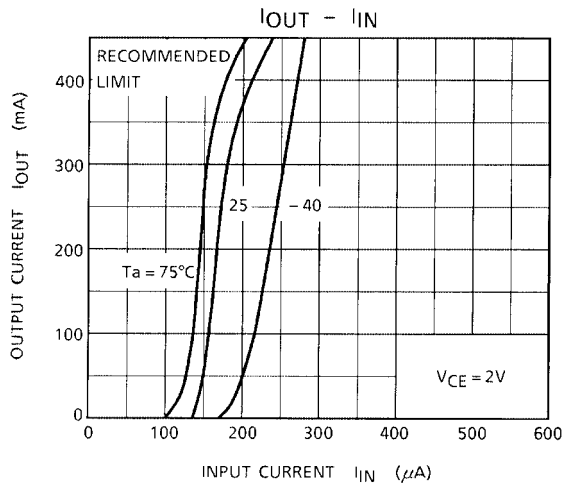
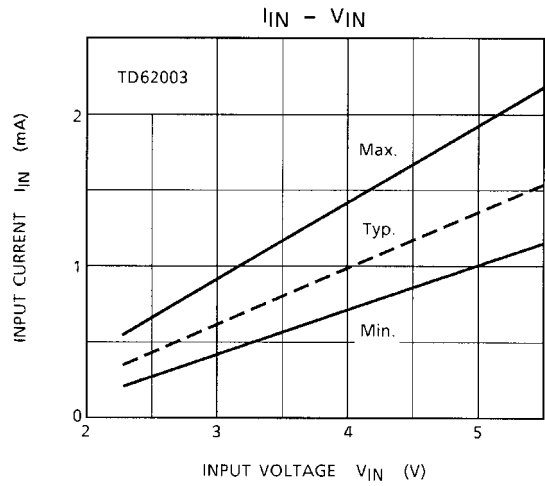
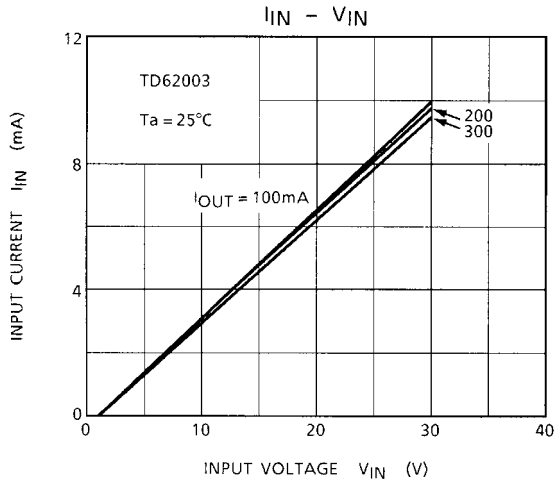

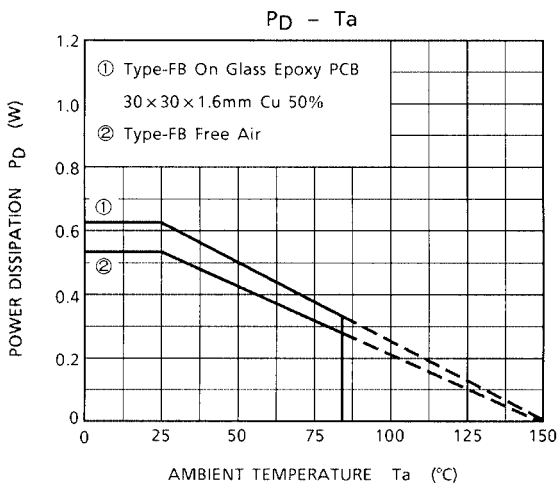
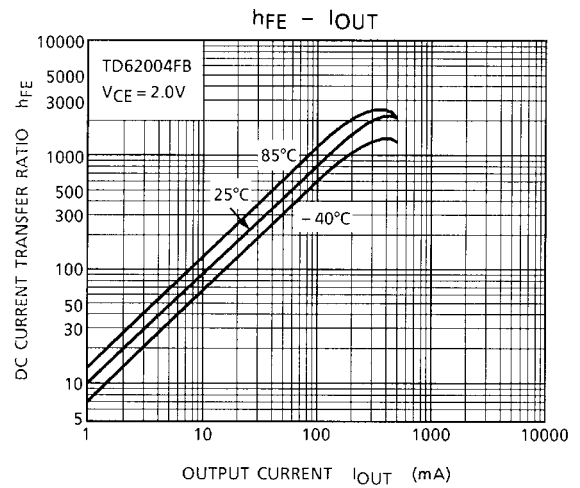
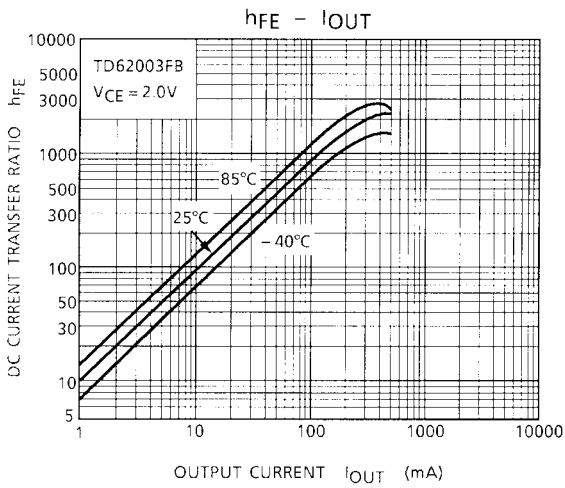
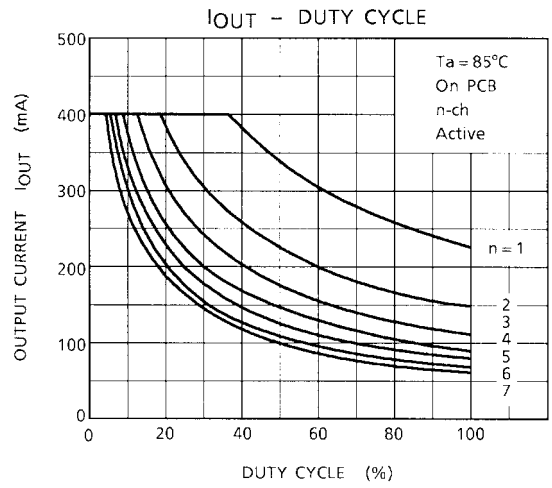
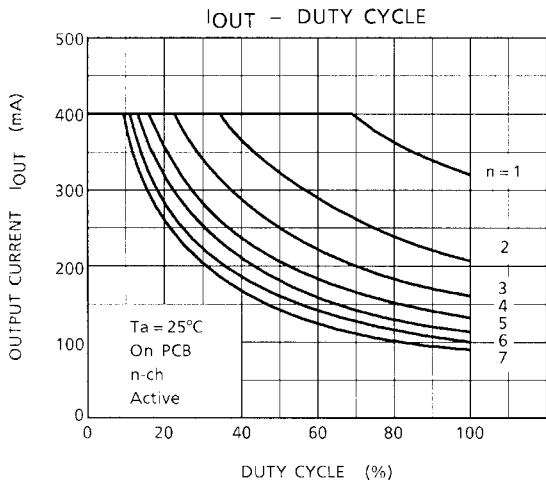

PACKAGE DIMENSIONS

SOP16-P-225-1.27B

Unit : mm

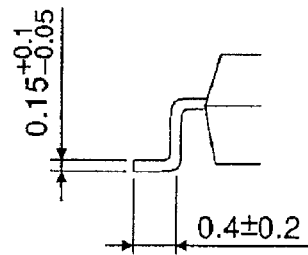
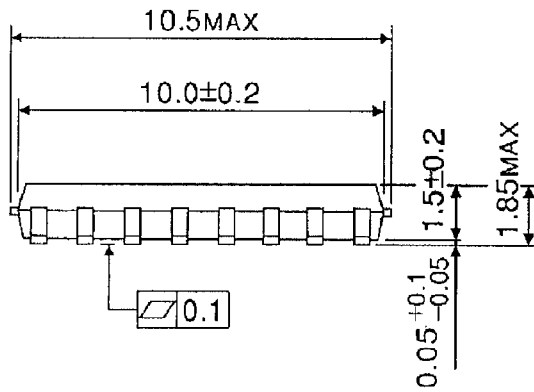
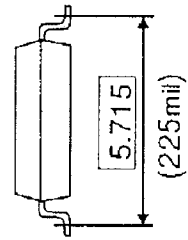
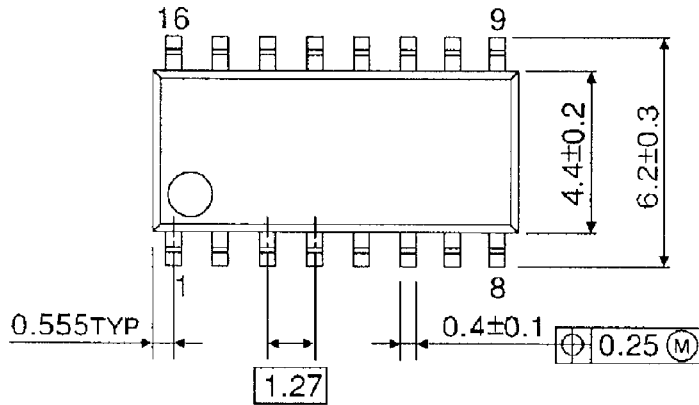

Weight: 0.16 g (Typ.)

RESTRICTIONS ON PRODUCT USE

000707EBA

- TOSHIBA is continually working to improve the quality and reliability of its products. Nevertheless, semiconductor devices in general can malfunction or fail due to their inherent electrical sensitivity and vulnerability to physical stress. It is the responsibility of the buyer, when utilizing TOSHIBA products, to comply with the standards of safety in making a safe design for the entire system, and to avoid situations in which a malfunction or failure of such TOSHIBA products could cause loss of human life, bodily injury or damage to property.
In developing your designs, please ensure that TOSHIBA products are used within specified operating ranges as set forth in the most recent TOSHIBA products specifications. Also, please keep in mind the precautions and conditions set forth in the "Handling Guide for Semiconductor Devices," or "TOSHIBA Semiconductor Reliability Handbook" etc..
- The TOSHIBA products listed in this document are intended for usage in general electronics applications (computer, personal equipment, office equipment, measuring equipment, industrial robotics, domestic appliances, etc.). These TOSHIBA products are neither intended nor warranted for usage in equipment that requires extraordinarily high quality and/or reliability or a malfunction or failure of which may cause loss of human life or bodily injury ("Unintended Usage"). Unintended Usage include atomic energy control instruments, airplane or spaceship instruments, transportation instruments, traffic signal instruments, combustion control instruments, medical instruments, all types of safety devices, etc.. Unintended Usage of TOSHIBA products listed in this document shall be made at the customer's own risk.
- The products described in this document are subject to the foreign exchange and foreign trade laws.
- The information contained herein is presented only as a guide for the applications of our products. No responsibility is assumed by TOSHIBA CORPORATION for any infringements of intellectual property or other rights of the third parties which may result from its use. No license is granted by implication or otherwise under any intellectual property or other rights of TOSHIBA CORPORATION or others.
- The information contained herein is subject to change without notice.