

## TD62003PA, TD62003APA, TD62004PA, TD62004APA

### 7CH DARLINGTON SINK DRIVER

The TD62003PA / APA Series are high-voltage, high-current darlington drivers comprised of seven NPN darlington pairs. All units feature integral clamp diodes for switching inductive loads. Applications include relay, hammer, lamp and display (LED) drivers.

### FEATURES

- Output current (single output) 500 mA (Max.)
- High sustaining voltage output  
35 V (Min.) (TD62003PA series)  
50 V (Min.) (TD62003APA series)
- Output clamp diodes
- Inputs compatible with various types of logic.  
TD62003PA, APA  $R_{IN} = 2.7 \text{ k}\Omega$   
TD62004PA, APA  $R_{IN} = 10.5 \text{ k}\Omega$
- Package DIP-16 pin

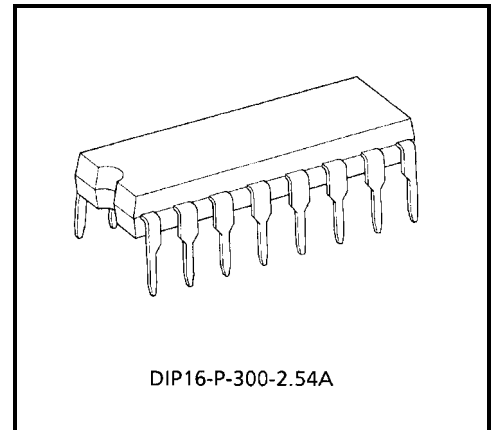

DIP16-P-300-2.54A

Weight: 1.11g (Typ.)

### PIN CONNECTION (TOP VIEW)

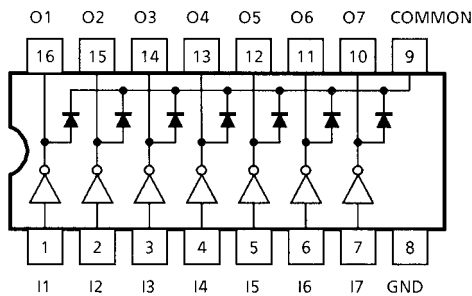

## SCHEMATICS (EACH DRIVER)

TD62003PA / APA

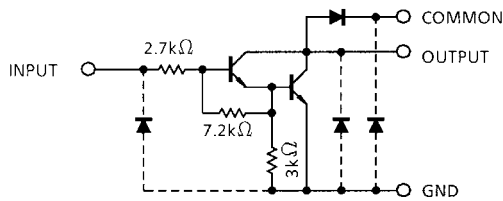

TD62004PA / APA

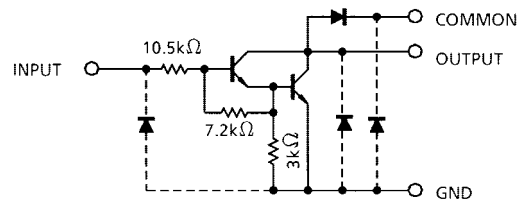

Note: The input and output parasitic diodes cannot be used as clamp diodes.

## MAXIMUM RATINGS (Ta = 25°C)

CHARACTERISTIC		SYMBOL	RATING	UNIT
Output Sustaining Voltage	PA	V <sub>CE (SUS)</sub>	-0.5~35	V
	APA		-0.5~50	
Output Current		I <sub>OUT</sub>	500	mA / ch
Input Voltage		V <sub>IN</sub>	-0.5~30	V
Clamp Diode Reverse Voltage	PA	V <sub>R</sub>	35	V
	APA		50	
Clamp Diode Forward Current		I <sub>F</sub>	500	mA
Power Dissipation		P <sub>D</sub>	1.47	W
Operating Temperature	PA	T <sub>opr</sub>	-30~75	°C
	APA		-40~85	
Storage Temperature		T <sub>stg</sub>	-55~150	°C

## RECOMMENDED OPERATING CONDITIONS

(Ta = -40~85°C for Type-APA and Ta = -30~75°C for Type-PA)

CHARACTERISTIC		SYMBOL	CONDITION	MIN	TYP.	MAX	UNIT	
Output Sustaining Voltage	PA	V <sub>CE (SUS)</sub>		0	—	35	V	
	APA			0	—	50		
Output Current	PA	I <sub>OUT</sub>	T <sub>pw</sub> = 25 ms 7 Circuits	Duty = 10%	0	—	370	mA / ch
				Duty = 50%	0	—	140	
	APA			Duty = 10%	0	—	400	
				Duty = 50%	0	—	170	
Input Voltage		V <sub>IN</sub>		0	—	24	V	
	TD62003	V <sub>IN (ON)</sub>	I <sub>OUT</sub> = 400 mA, h <sub>FE</sub> = 800	2.8	—	24	V	
				6.2	—	24		
	TD62004	V <sub>IN (OFF)</sub>		0	—	0.7	V	
			0	—	1.0			
Clamp Diode Reverse Voltage	PA	V <sub>R</sub>		—	—	35	V	
	APA			—	—	50		
Clamp Diode Forward Current		I <sub>F</sub>		—	—	350	mA	
Power Dissipation		P <sub>D</sub>	Ta = 85°C	—	—	0.52	W	

## ELECTRICAL CHARACTERISTICS (Ta = 25°C)

CHARACTERISTIC		SYMBOL	TEST CIR-CUIT	TEST CONDITION	MIN	TYP.	MAX	UNIT	
Output Leakage Current	APA	$I_{CEX}$	1	$V_{CE} = 50\text{ V}, T_a = 25^\circ\text{C}$	—	—	50	$\mu\text{A}$	
				$V_{CE} = 50\text{ V}, T_a = 85^\circ\text{C}$	—	—	100		
	PA			$V_{CE} = 35\text{ V}, T_a = 25^\circ\text{C}$	—	—	50		
				$V_{CE} = 35\text{ V}, T_a = 75^\circ\text{C}$	—	—	100		
Collector–Emitter Saturation Voltage		$V_{CE(sat)}$	2	$I_{OUT} = 350\text{ mA}, I_{IN} = 500\text{ }\mu\text{A}$	—	1.3	1.6	V	
				$I_{OUT} = 200\text{ mA}, I_{IN} = 350\text{ }\mu\text{A}$	—	1.1	1.3		
				$I_{OUT} = 100\text{ mA}, I_{IN} = 250\text{ }\mu\text{A}$	—	0.9	1.1		
DC Current Transfer Ratio		$h_{FE}$	2	$V_{CE} = 2\text{ V}, I_{OUT} = 350\text{ mA}$	1000	—	—		
Input Current (Output On)	TD62003	$I_{IN(ON)}$	3	$V_{IN} = 2.4\text{ V}, I_{OUT} = 350\text{ mA}$	—	0.4	0.7	mA	
	TD62004			$V_{IN} = 9.5\text{ V}, I_{OUT} = 350\text{ mA}$	—	0.8	1.3		
	PA	$I_{IN(OFF)}$	4	$I_{OUT} = 500\text{ }\mu\text{A}, T_a = 75^\circ\text{C}$	50	65	—	$\mu\text{A}$	
	APA			$I_{OUT} = 500\text{ }\mu\text{A}, T_a = 85^\circ\text{C}$	50	65	—		
Input Voltage (Output On)	TD62003	$V_{IN(ON)}$	5	$V_{CE} = 2\text{ V}$ $h_{FE} = 800$	$I_{OUT} = 350\text{ mA}$	—	—	2.6	V
					$I_{OUT} = 200\text{ mA}$	—	—	2.0	
	TD62004				$I_{OUT} = 350\text{ mA}$	—	—	4.7	
					$I_{OUT} = 200\text{ mA}$	—	—	4.4	
Clamp Diode Reverse Current	APA	$I_R$	6	$V_R = 50\text{ V}, T_a = 25^\circ\text{C}$	—	—	50	$\mu\text{A}$	
				$V_R = 50\text{ V}, T_a = 85^\circ\text{C}$	—	—	100		
	PA			$V_R = 35\text{ V}, T_a = 25^\circ\text{C}$	—	—	50		
				$V_R = 35\text{ V}, T_a = 75^\circ\text{C}$	—	—	100		
Clamp Diode Forward Voltage		$V_F$	7	$I_F = 350\text{ mA}$	—	—	2.0	V	
Input Capacitance		$C_{IN}$	—		—	15	—	pF	
Turn–On Delay	PA	$t_{ON}$	8	$V_{OUT} = 35\text{ V}, R_L = 85\text{ }\Omega$ $C_L = 15\text{ pF}$	—	0.1	—	$\mu\text{s}$	
	APA			$V_{OUT} = 50\text{ V}, R_L = 125\text{ }\Omega$ $C_L = 15\text{ pF}$	—	0.1	—		
Turn–Off Delay	PA	$t_{OFF}$	8	$V_{OUT} = 35\text{ V}, R_L = 85\text{ }\Omega$ $C_L = 15\text{ pF}$	—	0.2	—		
	APA			$V_{OUT} = 50\text{ V}, R_L = 125\text{ }\Omega$ $C_L = 15\text{ pF}$	—	0.2	—		

**TEST CIRCUIT**

**1.  $I_{CEX}$**

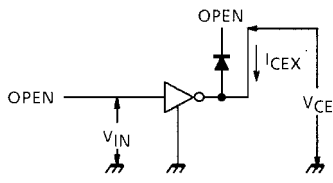

**2.  $V_{CE(sat)}$ ,  $h_{FE}$**

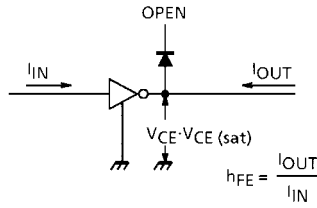

**3.  $I_{IN(ON)}$**

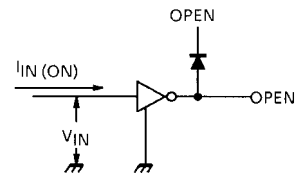

**4.  $I_{IN(OFF)}$**

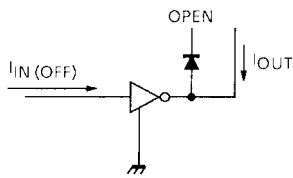

**5.  $V_{IN(ON)}$**

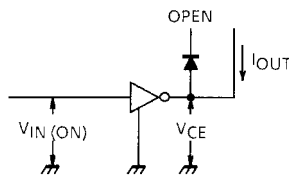

**6.  $I_R$**

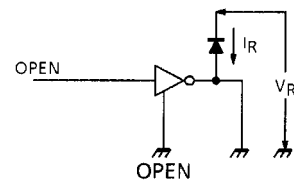

**7.  $V_F$**

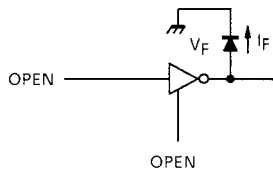

**8.  $t_{ON}$ ,  $t_{OFF}$**

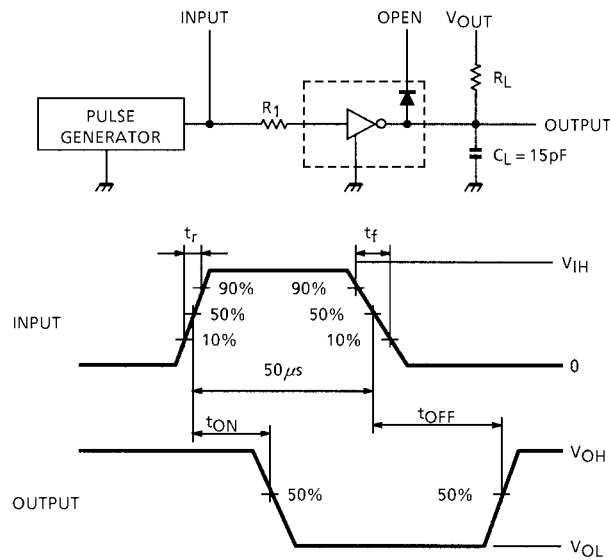

Note 1: Pulse Width 50  $\mu$ s, Duty Cycle 10%  
 Output Impedance 50  $\Omega$ ,  $t_r \leq 5$ ns,  $t_f \leq 10$ ns

Note 2: See below

**INPUT CONDITION**

TYPE NUMBER	$R_I$	$V_{IH}$
TD620003PA / APA	0	3 V
TD620004 / APA	0	8 V

Note 3:  $C_L$  includes probe and jig capacitance

**PRECAUTIONS for USING**

This IC does not include built-in protection circuits for excess current or overvoltage.

If this IC is subjected to excess current or overvoltage, it may be destroyed.

Hence, the utmost care must be taken when systems which incorporate this IC are designed. Utmost care is necessary in the design of the output line, COMMON and GND line since IC may be destroyed due to short-circuit between outputs, air contamination fault, or fault by improper grounding.

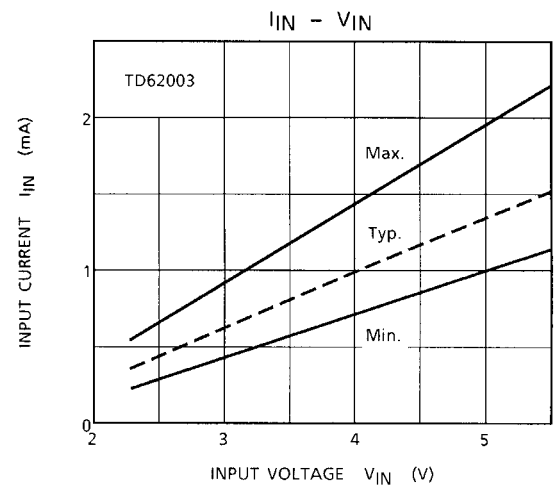
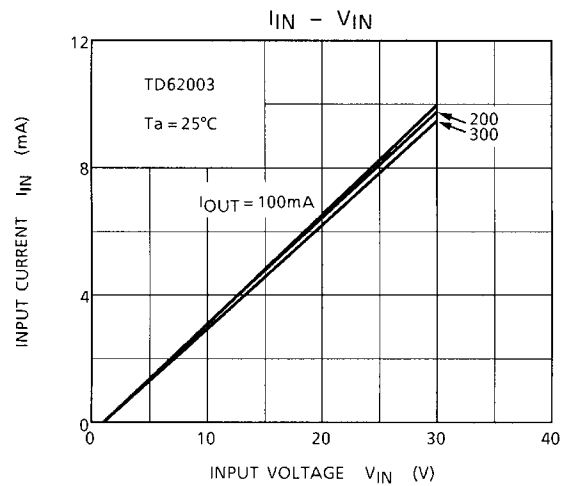
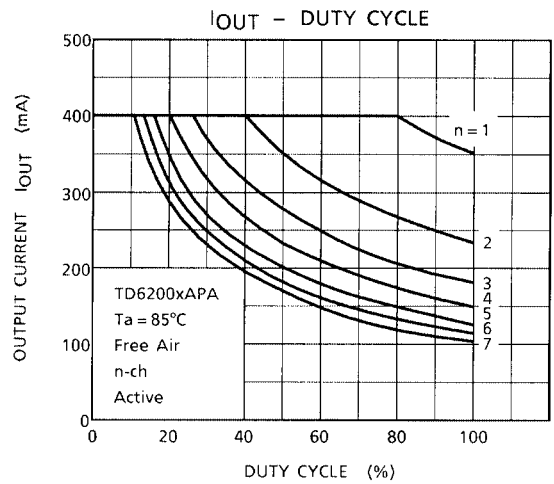
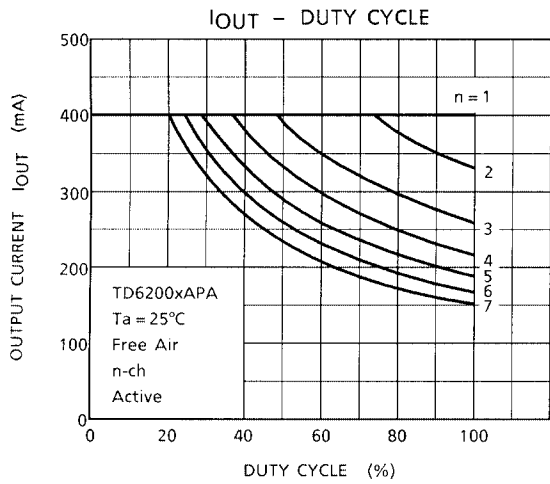
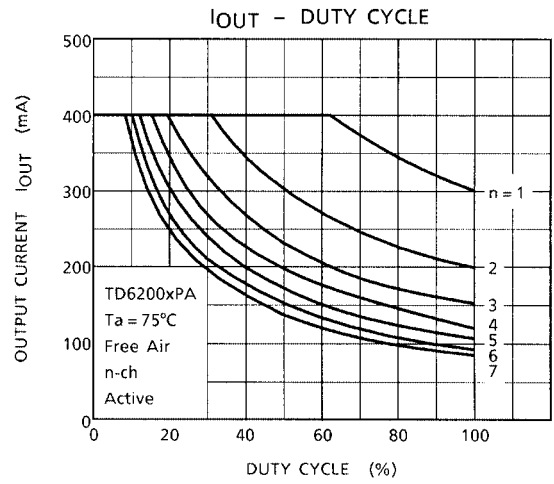
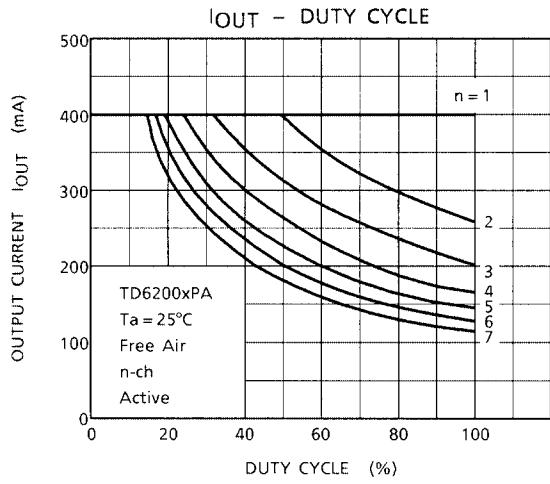

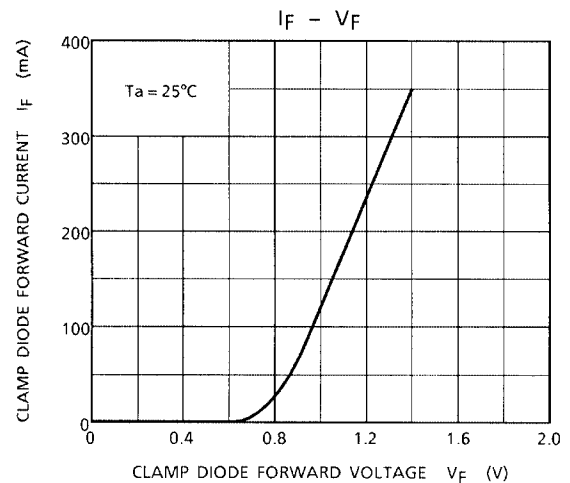
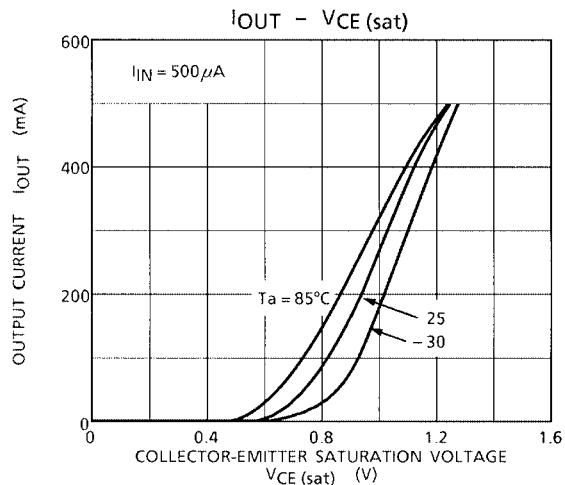
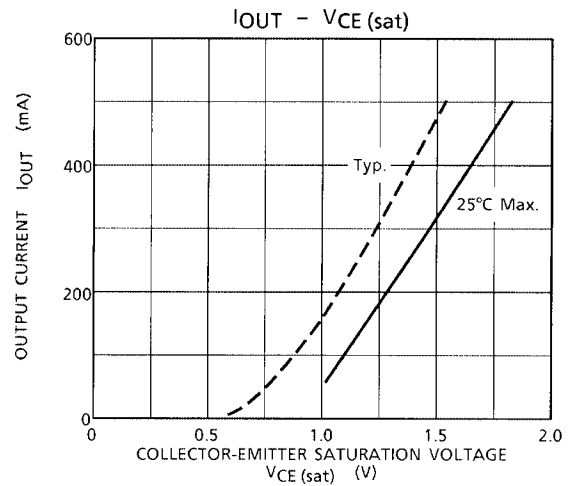
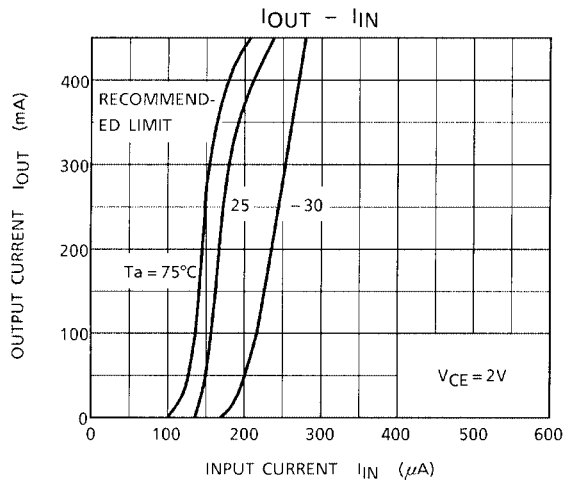
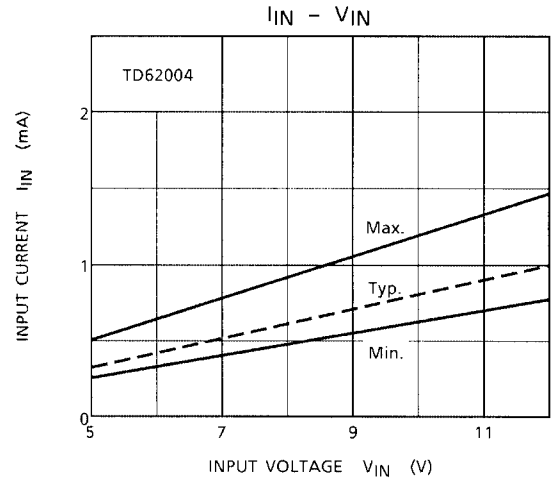
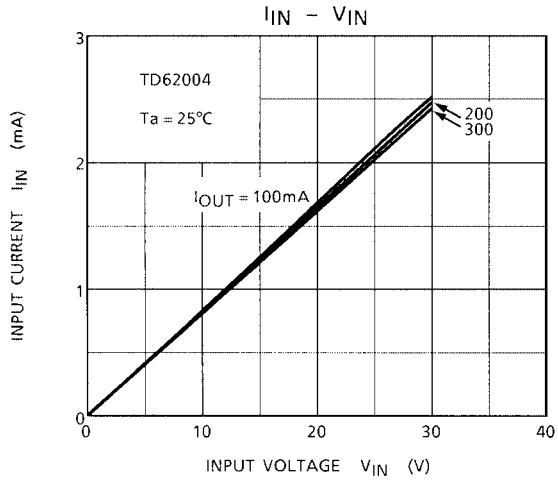

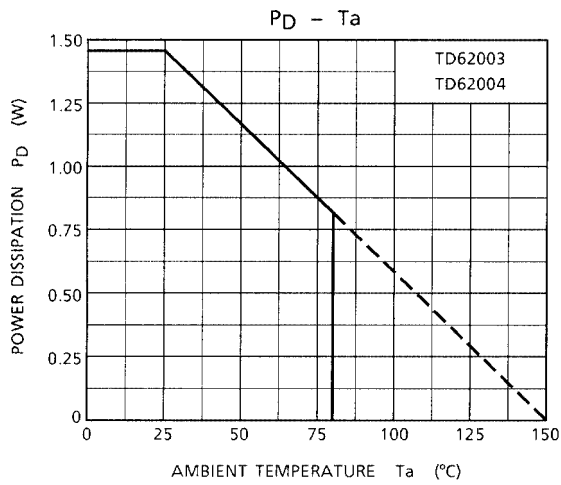
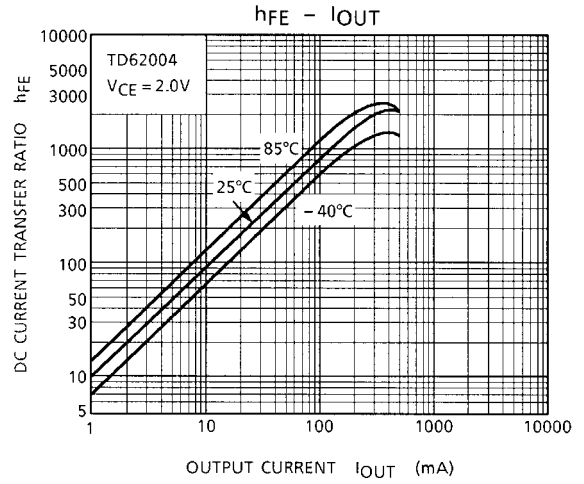
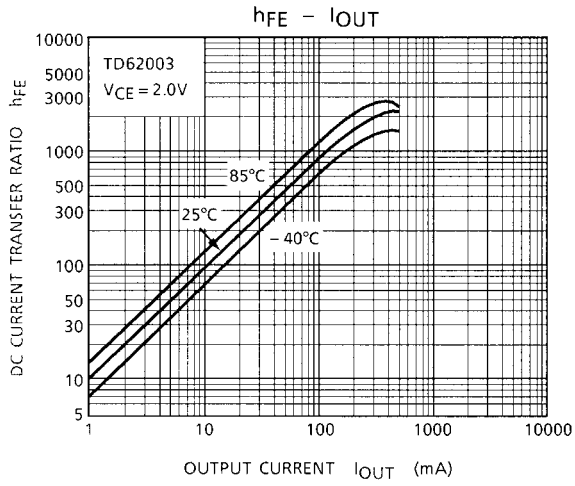



## PACKAGE DIMENSIONS

DIP16-P-300-2.54A

Unit : mm

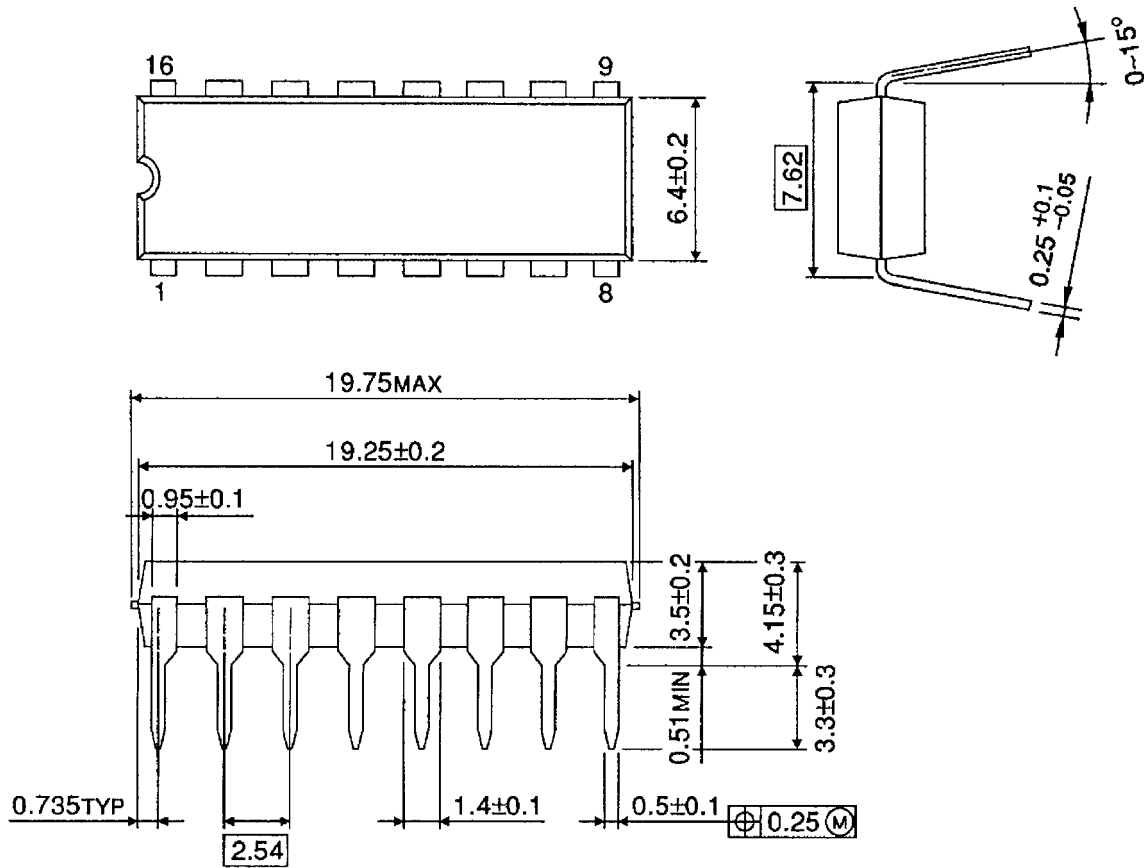

Weight: 1.11 g (Typ.)

**RESTRICTIONS ON PRODUCT USE**

000707EBA

- TOSHIBA is continually working to improve the quality and reliability of its products. Nevertheless, semiconductor devices in general can malfunction or fail due to their inherent electrical sensitivity and vulnerability to physical stress. It is the responsibility of the buyer, when utilizing TOSHIBA products, to comply with the standards of safety in making a safe design for the entire system, and to avoid situations in which a malfunction or failure of such TOSHIBA products could cause loss of human life, bodily injury or damage to property.  
In developing your designs, please ensure that TOSHIBA products are used within specified operating ranges as set forth in the most recent TOSHIBA products specifications. Also, please keep in mind the precautions and conditions set forth in the "Handling Guide for Semiconductor Devices," or "TOSHIBA Semiconductor Reliability Handbook" etc..
- The TOSHIBA products listed in this document are intended for usage in general electronics applications (computer, personal equipment, office equipment, measuring equipment, industrial robotics, domestic appliances, etc.). These TOSHIBA products are neither intended nor warranted for usage in equipment that requires extraordinarily high quality and/or reliability or a malfunction or failure of which may cause loss of human life or bodily injury ("Unintended Usage"). Unintended Usage include atomic energy control instruments, airplane or spaceship instruments, transportation instruments, traffic signal instruments, combustion control instruments, medical instruments, all types of safety devices, etc.. Unintended Usage of TOSHIBA products listed in this document shall be made at the customer's own risk.
- The products described in this document are subject to the foreign exchange and foreign trade laws.
- The information contained herein is presented only as a guide for the applications of our products. No responsibility is assumed by TOSHIBA CORPORATION for any infringements of intellectual property or other rights of the third parties which may result from its use. No license is granted by implication or otherwise under any intellectual property or other rights of TOSHIBA CORPORATION or others.
- The information contained herein is subject to change without notice.